

AlgoForce™

E1500

User Manual V1.0.9



*Uncover Gold with Ultra-Fine Pulse Induction Technology:
VLF Sensitivity, PI Power, Affordable Excellence!
Designed & Assembled in Australia by ALGOFORCE PTY LTD*

Table of Contents

Introduction	3
Key Features	4
Carton Contents	6
Assembly	7
Quick Start	9
User Settings	12
Software Upgrade Instruction	15
Bug Report and Feature Request	16
Safety and Care	16
EMC Compliance	16
Returns Policy	17
Warranty Information	18
Specifications	19
Release Note for Software V1.0.9	20
Release Note for Software V1.0.8	20

Introduction

Metal detectors serve as indispensable tools for treasure hunters and gold prospectors. They come in two basic types: VLF (very low frequency) and PI (pulse induction), with each technology having its own positive and negative characteristics. In this brief introduction, we will discuss the differences between these two types, and introduce you to the AlgoForce E1500, a pulse induction metal detector distinguished by its exceptional performance, unique features and cost-effectiveness.

VLF metal detectors are effective at locating relatively shallow gold nuggets in soils with low mineralisation, and their generally lower cost makes them an attractive proposition for novices. However, their performance is drastically reduced as soil mineralisation levels increase, and the presence of hot rocks can quickly turn excitement into frustration.

PI, or Pulse Induction metal detectors generally provide superior performance in mineralised terrains, being able to ignore most of the minerals you don't want to detect. Virtually all serious gold prospectors opt for PI detectors owing to their ability in handling highly mineralised soils, but when it comes to the detection of small gold nuggets, many pulse induction detectors released in the past have often fallen short in sensitivity compared to VLF detectors. Furthermore, most PI detectors come at a much higher price tag compared to their VLF counterparts.

The AlgoForce E1500 is a pulse induction metal detector that excels at locating small gold nuggets in often complex mineralised soils found in most goldfields, all at a remarkably reasonable cost. Developed by AlgoForce Pty Ltd, it harnesses patented Ultra-Fine pulse induction technology, which is capable of detecting even the tiniest of gold nuggets. This sensitivity matches that of VLF gold detectors in low mineral soils, but being a PI detector, it has a bigger advantage in highly mineralised terrains. Additionally, the detector incorporates a dual ground balanced detection channel design, enabling the detection of nuggets of varying sizes.

For experienced PI users accustomed to estimating nugget size from audio cues, the AlgoForce E1500 can also help to estimate size or conductivity through its stable conductive target ID (0-99), even in highly mineralised soils.

High single frequency VLF detectors typically struggle with signals on wet ocean sand, where PI detectors are far more capable of detecting through the salt mineralisation. Capitalising on its Ultra-Fine pulse induction technology and stable conductive target ID (0-99), the AlgoForce E1500 excels on the beach, proving to be a versatile tool for searching fine jewellery, coins, rings, and other treasures.

With its patented built-in microphone for ambient sound awareness, real-time scrolling detection signal display, a frequency noise level graph for effortless manual frequency selection, ergonomic and lightweight mechanical design, compatibility with aftermarket coils, the convenience of universal USB power bank support, and an integrated loudspeaker, the AlgoForce E1500 emerges as a robust and user-friendly metal detector. This versatile tool has been carefully engineered to cater to the needs of both amateur gold hunters and seasoned prospectors.

In conclusion, both VLF and PI metal detectors come with their own array of advantages and limitations. The choice between the two hinges on the user's specific requirements and budget. The AlgoForce E1500 bridges the gap, offering a high-performance, cost-effective PI alternative for users seeking a detector that combines VLF's sensitivity to small nuggets and fine jewellery, but with Pulse Inductions ability to detect in mineralised soils and on beaches.

AlgoForce E1500

Key Features



- Lightweight (840g without coil or powerbank)
- Collapsible to flat style for compact storage

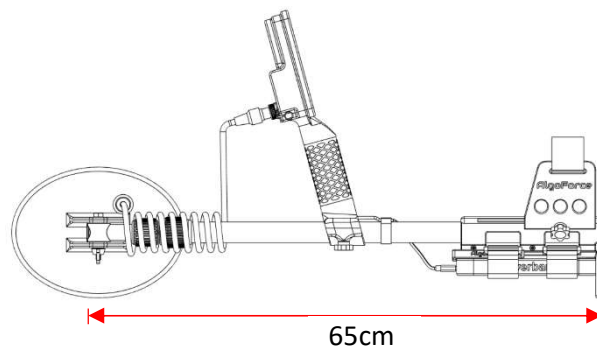

Note:

1. Powerbank is not included in the package
2. Nugget Finder 8"x6" Sadie coil is optional

AlgoForce E1500

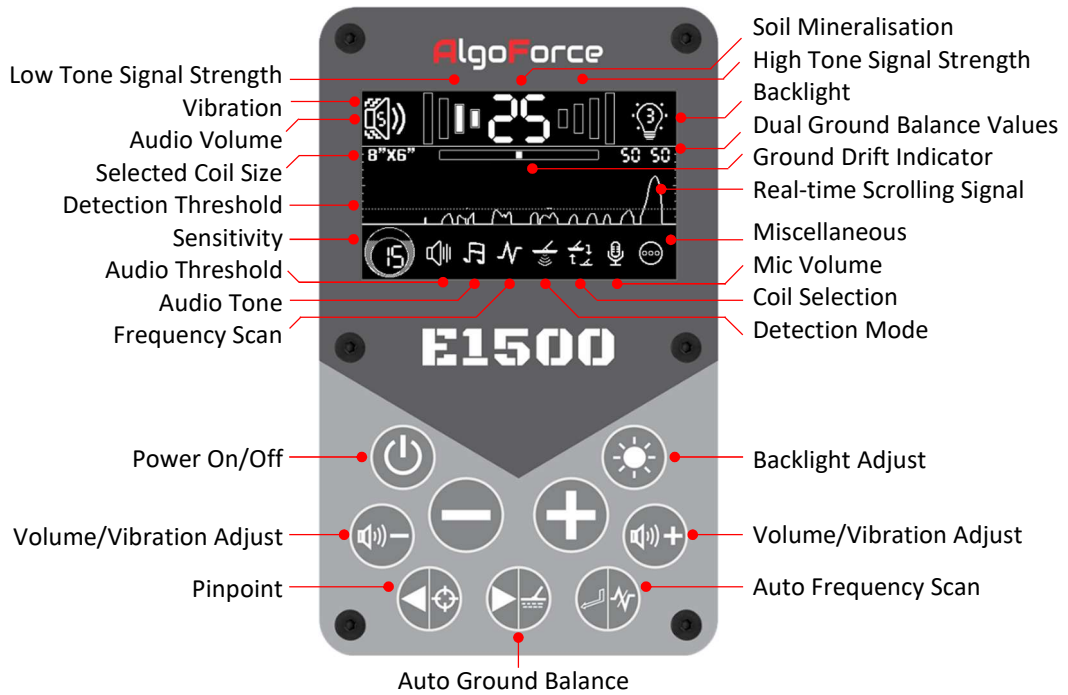

- Patented Ultra-Fine Pulse Induction Technology for Detecting Small Gold Nuggets
- Patented Technology for Ambient Sound Awareness in Headphone Mode
- Stable Conductive Target ID (0-99) in Pinpoint Mode even in Highly Mineralised Soils

Conductive Target ID

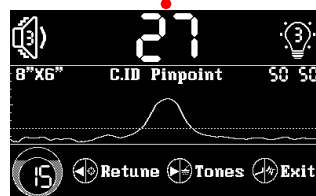

- Dual Ground Balanced Detection Channels for Different Sized Nuggets
- Four Detection Modes (Ultra-Fine, Fine, Normal, Large)
- Exceptional Performance in Finding Fine Jewellery, Coins, and Other Treasures on the Beach
- Two Display Themes (Dark, Light)

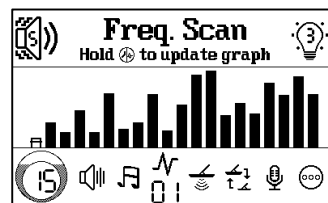
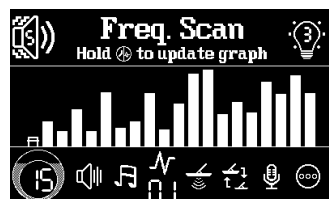

- Frequency Noise Level Graph for Effortless Manual Frequency Selection
- Free and Intuitive Software Upgrade

AlgoForce E1500

NOTE: The strength of the E1500 lies in its sensitivity to small nuggets. Therefore, we have only tested the E1500 with small to medium coils. The largest coil we tested is the NF 14"x9" Evo. Although, in theory, larger coils will work with the E1500 without any problem, the shaft could rotate slightly and become wobbly when extra-large and heavy coils are used. The shaft is made of 3 pieces of carbon fiber rods. The lower piece cannot rotate with respect to the middle piece. However, the middle piece can rotate freely with respect to the upper piece when the upper hand-tighten spin lock is released. This is by design. This design offers advantages such as the ability to rotate the coil for compact storage and accommodating users who prefer a slight tilt in the handle for comfort. For small to medium-sized coils, the upper hand-tighten spin lock can firmly secure the middle piece when tightened. However, for extra-large and heavy coils, it could become slightly loose. Please also note that over-tightening the spin locks could cause damage to them.

Carton Contents



- * No actual size representation
- * Package-specific carry case, carry bag, USB cable, screws, and straps
- * Illustrative only images used
- * The AlgoForce E1500 Basic Package does not include either a coil or a power bank

AlgoForce E1500

Assembly

1-2. Plug the USB cable into the control box.

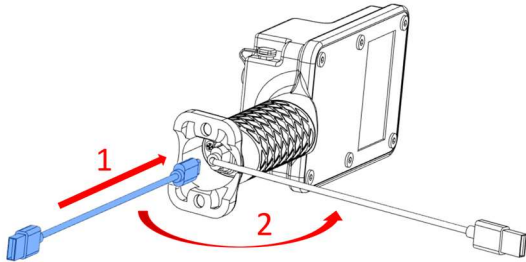

3-4. Mount the control box onto the stem using the two longer M5 screws.

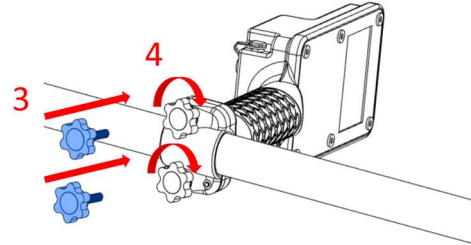

5. Install the standard or large arm strap onto the arm cuff based on your arm size.

6. Position the arm cuff on the sliding rail and fasten it with the two shorter M5 screws.

7. Position the powerbank stopper.

8. Fix the powerbank stopper to the sliding rail.

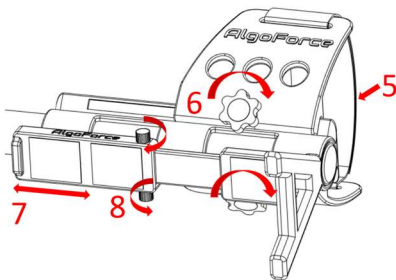

9. Put the powerbank in the holder.

10. Secure the powerbank with two straps.

11. Connect the USB cable to the powerbank.

12. Secure the USB cable with a cable strap.

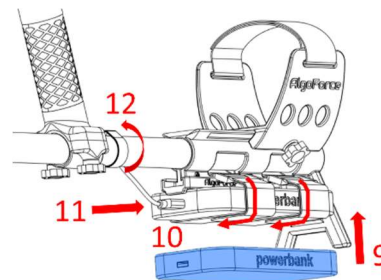

13. Release the two twist locks.

14. Extend the rods. The middle-piece rod is designed to rotate freely with the upper-piece rod when the upper twist lock is released.

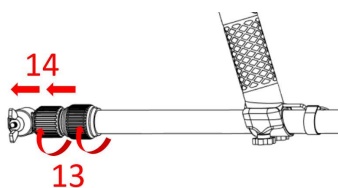

15-16. Align the hole of the coil yoke with the hole of the lower-piece rod. Then attach the coil to the coil yoke and the lower-piece rod.

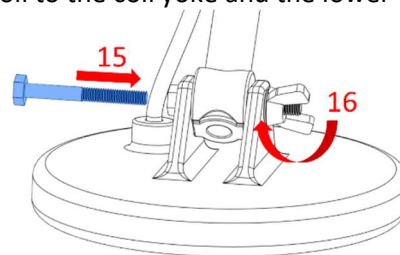

17. If necessary, rotate the coil to the correct orientation.

18. Lock the two twist locks.

19. Arrange the coil cable.

20. Secure the coil cable with two cable straps.

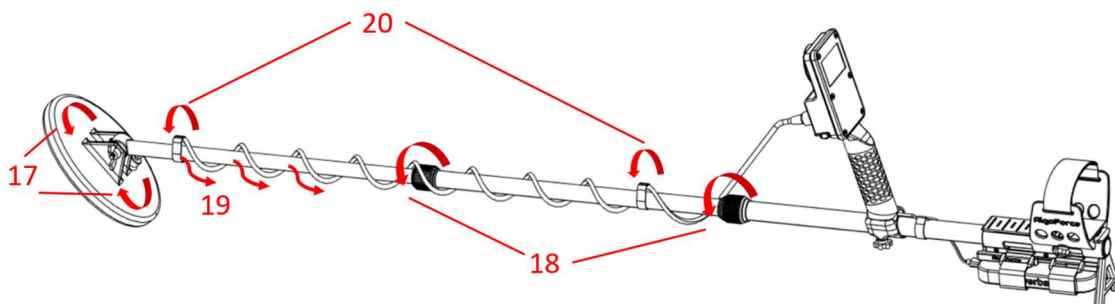

AlgoForce E1500

21-22. Connect the coil connector to the control box.

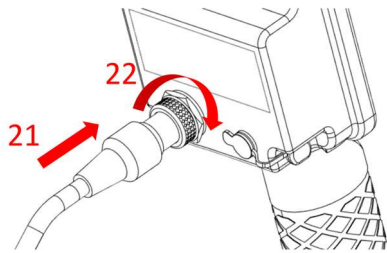

23. Plug in the headphone to the control box (optional).

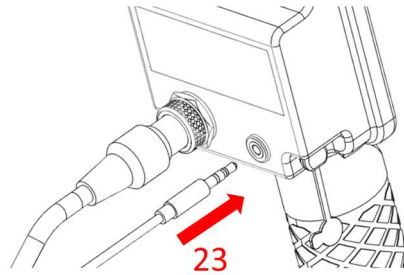

For Storage:

24. Release the two twist locks.

25. Collapse the rods and rotate the coil for compact storage.

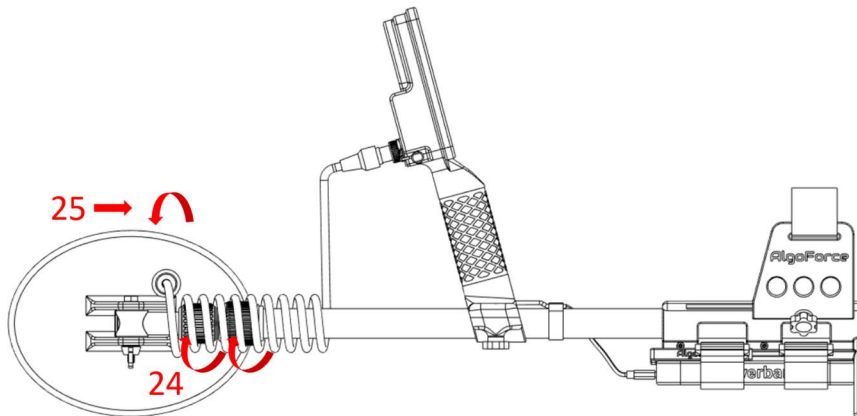

Quick Start

Press **Vol/Vibration** buttons to modify Audio Volume. Hold **Vol/Vibration** buttons to adjust Vibration. Press the **Backlight Adjust** button for backlight control. Use the **Minus** and **Plus** buttons to modify Sensitivity.

To adjust other settings:

- 1) Press **Right/Auto GB** in the Main Detection UI to access the menu.
- 2) Navigate with **Left/Pinpoint** or **Right/Auto GB**.
- 3) Modify selected setting with **Minus** or **Plus**.
- 4) Press **Return/Auto FS** to go back to the Main Detection UI.

I. Power On

Connect the power bank to the control box and turn it on. To power the detector, hold the **Power On/Off** button for 3 seconds, then release. Repeat to turn it off.

II. Factory Reset (if necessary)

Hold the **Minus** and **Plus** buttons for 3 seconds in Miscellaneous.

III. Calibrate Coil (see Coil Selection in page 13)

IV. Perform Auto Frequency Scan (Auto FS)

(if necessary to select the quietest frequency to eliminate electromagnetic interference)

Activate Auto FS by holding the **Return/Auto FS** button in the Main Detection UI. The Auto FS process takes 50 seconds. The noise levels of the scanned frequencies will be displayed.

V. Set Sensitivity, Audio Settings, and Vibration (to preferred levels)

Adjust Sensitivity so that the peak of the Real-time Scrolling Detection Signal is close to the Detection Threshold when there is no target.

VI. Perform Auto Ground Balance (Auto GB)

(to eliminate ground response)

Hold the **Right/Auto GB** button. Raise and lower the coil until the ground response is minimized or two short beeps are heard, then release the button. The Auto GB In Progress Indicator flashes when Auto GB is in progress. Auto GB can be performed in both the Main Detection UI and Pinpoint UI.

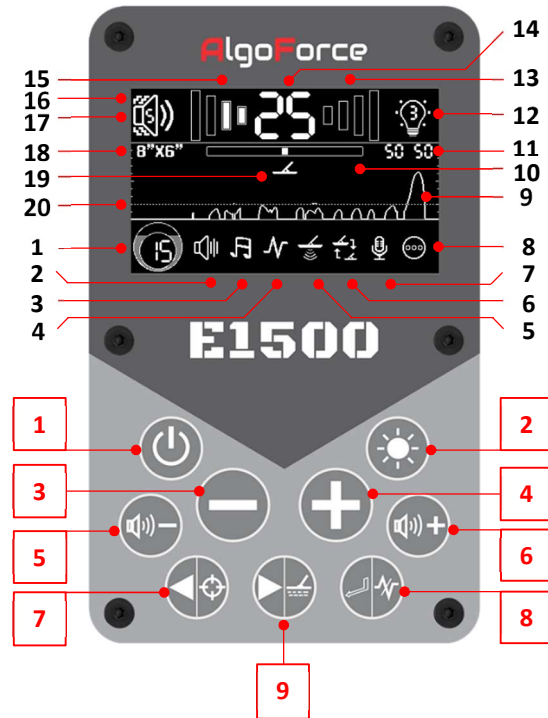

Main Detection UI

- | | |
|---|--------------------|
| 1. Sensitivity | 2. Audio Threshold |
| 3. Audio Tone | 4. Frequency Scan |
| 5. Detection Mode | 6. Coil Selection |
| 7. Mic Volume | 8. Miscellaneous |
| 9. Real-time Scrolling Detection Signal | |
| 10. Ground Drift Indicator (G.D.I) | |
| 11. Dual Ground Balance Values | |
| 12. Backlight Level | |
| 13. High Tone Signal Strength | |
| 14. Soil Mineralisation | |
| 15. Low Tone Signal Strength | |
| 16. Vibration Level | |
| 17. Audio Volume Level | |
| 18. Selected Coil Size | |
| 19. Auto GB In Progress Indicator | |
| 20. Detection Threshold | |

- | | |
|-------------------|--------------------|
| 1 Power On/Off | 2 Backlight Adjust |
| 3 Minus | 4 Plus |
| 5 Vol/Vibration ↓ | 6 Vol/Vibration ↑ |
| 7 Left/Pinpoint | 8 Return/Auto FS |
| 9 Right/Auto GB | |

VII. Begin Detecting

Keep the coil close to the ground and swing it left and right at a pace of about 1 m/s. Ideally, maintain a constant distance between the coil and the ground surface during the swing to avoid picking up excess ground noise. The detector will continuously monitor the ground drift in the background, presenting it as a horizontal bar in the Main Detection UI. If the Ground Drift Indicator bar widens, initiate Auto GB once more. It is essential to be aware that target signals can influence the Ground Drift Indicator. Therefore, for precise ground drift monitoring, ensure that no targets are detected.

VIII. Pinpoint detected target (if needed)

Enter the Pinpoint UI by pressing the **Left/Pinpoint** button in the Main Detection UI. In the Pinpoint UI, adjust Sensitivity with the **Minus** or **Plus** button. To retune the detection threshold due to ground variation or temperature drift, press the **Left/Pinpoint** button as needed. Switch audio settings by pressing the **Right/Auto GB** button. Perform Auto GB if needed by holding the **Right/Auto GB** button. Return to the Main Detection UI by pressing the **Return/Auto FS** button.

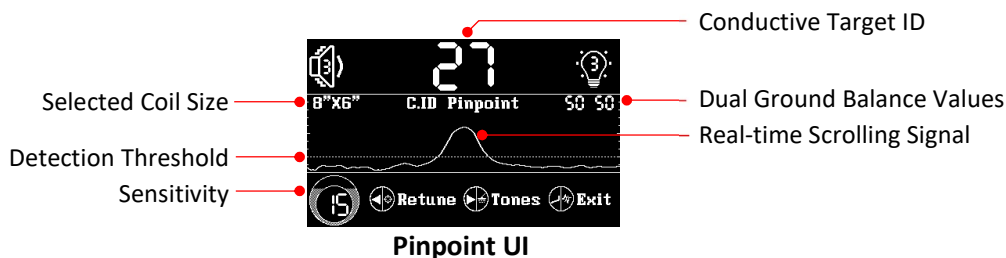

Pinpoint is a non-motion mode where the coil doesn't have to move to indicate a target. The detection signal gets stronger as the coil approaches the target, causing the audio (if audio output is on) or vibration (if vibration mode is on) to intensify.

The Conductive Target ID (0-99) displayed in the Pinpoint UI remains stable even in highly mineralised soils. A higher number indicates a larger or more conductive target. To obtain an accurate target ID, it is recommended to follow these steps:

- Move the coil away from but close to the target.
- Ensure the coil is resting on the ground surface and press the **Left/Pinpoint** button to retune.
- After that, slide the coil on the ground surface until the target is positioned just below the centre of the coil.

The conductivity target ID is also useful for assessing the target's shape. If the target ID fluctuates significantly when the coil is moved slightly off but still above the target, it likely indicates an irregularly shaped target, such as a bottle cap or a nail with a large head.

There are three audio settings within the pinpoint mode: C.ID Pinpoint, C.ID 5 Tones and C.ID 100 Tones. 'C.ID' stands for Conductivity Target ID. Users can seamlessly switch between audio settings by briefly pressing the **Right/Auto GB** button while in pinpoint mode.

C.ID Pinpoint:

As in previous software releases, in C.ID Pinpoint audio setting, audio pitch correlates with signal strength, with higher pitches indicating stronger signals. Tailored for precise pinpointing of target locations.

C.ID 5 Tones:

Audio pitch is determined by conductivity target ID, providing distinct audio feedback for different target ranges. Conductivity target ID ranges 0-19, 20-39, 40-59, 60-79, and 80-99 correspond to audio pitches of 330Hz, 490Hz, 650Hz, 810Hz, and 970Hz, respectively.

C.ID 100 Tones:

Each conductivity target ID is associated with a unique audio pitch ranging from 250Hz to 1042Hz. Higher conductivity target IDs produce higher audio pitches, facilitating differentiation of targets.

In C.ID Pinpoint audio setting, users retain the ability to adjust the audio threshold through the Threshold setting. In both C.ID 5 Tones audio setting and C.ID 100 Tones audio setting, the audio threshold is fixed at zero. This ensures ease of differentiation between conductivity target IDs solely based on unique audio pitches, eliminating potential confusion with the audio threshold.

If a pinpointer is used to pinpoint the target and you find that the detector is interfering with the pinpointer, you can turn off the detector's transmitter by double-clicking the **Power On/Off** button. To turn back on the transmitter, simply press any button.

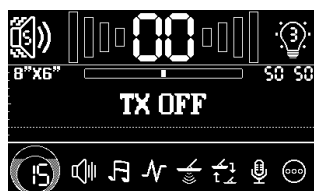

User Settings

Audio Volume: Modify by pressing the **Vol/Vibration** buttons.

Vibration: Adjust by holding the **Vol/Vibration** buttons.

Pinpoint mode has separate volume and vibration controls from the main detection mode.

Backlight Level: Control by pressing the **Backlight Adjust** button.

Sensitivity: Modify in the Main Detection UI or the Pinpoint UI using the **Minus** and **Plus** buttons.

To adjust other settings:

- 1) Press **Right/Auto GB** in the Main Detection UI to access the menu.
- 2) Navigate with **Left/Pinpoint** or **Right/Auto GB**.
- 3) Modify selected setting with **Minus** or **Plus**.
- 4) Press **Return/Auto FS** to go back to the Main Detection UI.

1. Sensitivity

Adjust Sensitivity so that the peak of the Real-time Scrolling Detection Signal is close to the Detection Threshold when there is no target.



2. Audio Threshold

Audio Threshold adjusts the volume of the constant background hum added to the detection audio. It's recommended to set it to a level that's just barely audible.



3. Audio Tone

The Audio Tone setting adjusts the frequency of the constant background hum added to the detection audio. The tone can be set according to personal preference.



4. Frequency Scan

The real-time noise level of the selected frequency and the past noise levels from the last Auto FS are displayed in a graph for convenient manual frequency selection. If Auto FS hasn't been run since a factory reset, the past noise levels are displayed as gray bars of equal height. To choose a relatively quiet frequency with a low noise level, press **Minus** or **Plus**.

Electromagnetic interference often changes. The past noise levels from the last Auto FS may not accurately reflect the current real-time noise levels. If necessary, hold the **Return/Auto FS** button to update the past noise level to the current real-time noise level.

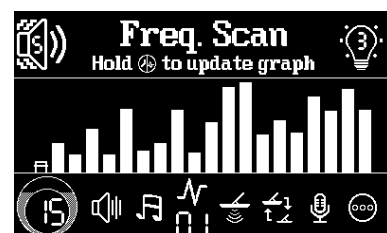
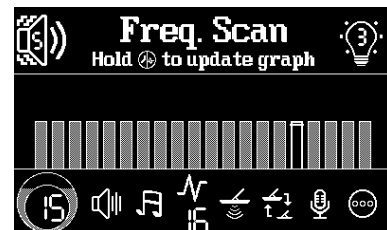

5. Detection Mode

The device offers four distinct detection modes: Ultra-Fine Gold, Fine Gold, Normal Gold, and Large Gold.

Ultra-Fine Gold: This is the go-to choice for detecting gold nuggets of all sizes and is suitable for most situations. When used in combination with the Nugget Finder 8"x6" Sadie coil or similar-sized coils, it excels, even in highly mineralised soils. This combination is strongly recommended for locating small gold nuggets in various ground conditions.

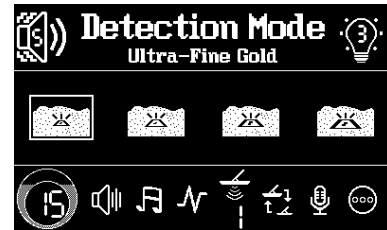

Fine Gold: Fine Gold mode reduces sensitivity to mineralised soil and may not detect very small gold nuggets. When paired with the Nugget Finder 12"x8" Mono coil or similar-sized coils, this mode performs exceptionally well, even in highly mineralised soils. It's a top choice for finding small to medium gold nuggets in different ground conditions.

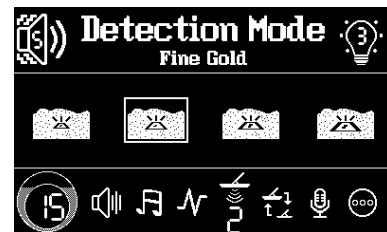

Normal Gold: This mode decreases sensitivity to highly mineralised soil and may not detect small gold nuggets. When used with the Nugget Finder 14"x9" Mono coil or similar-sized coils, it delivers outstanding performance, even in highly mineralised soils. It is highly recommended for locating medium to large gold nuggets in various ground conditions.

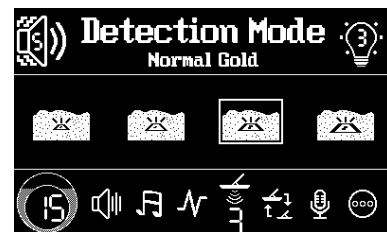

Large Gold: Reserve Large Gold mode for use in extremely mineralised soil with high levels of wet salt. When used with coils larger than the Nugget Finder 14"x9" Mono coil, this mode excels, even in highly mineralised soils. This combination is highly recommended for locating large gold nuggets in different ground conditions.

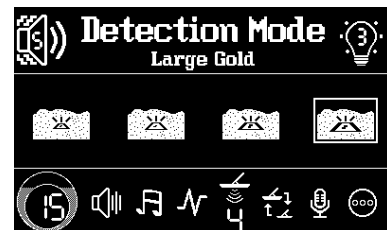

Although the four detection modes are specially designed for detecting gold nuggets, they can also be used for finding jewellery, coins, and other treasures on the beach. With a small coil like the Nugget Finder 8"x6" Sadie, use Ultra-Fine or Fine Gold mode for fine treasures. For a large coil like the 14"x9" Evolution Mono, employ Normal or Large Gold mode for deep beach discoveries. No ground balance is needed. As a PI detector, the AlgoForce E1500 naturally rejects seawater signals; the detection mode dictates the level of rejection, ranging from Ultra-Fine Gold to Large Gold, becoming more aggressive.

6. Coil Selection

In the Coil Selection setting, there are five coil icons, each storing the calibration parameters and the coil size for a different coil. This means the detector can store calibration parameters for up to five coils.

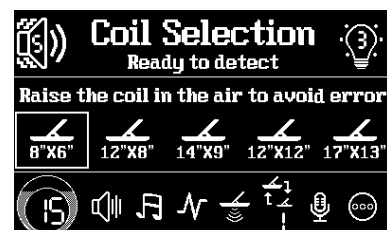

If the package comes with a coil, its calibration parameters will be saved as the default parameters for all the coil icons. If it doesn't, the parameters of a factory-designated standard coil will be used as the default. Factory reset does not change the coil icons' calibration parameters or coil size.

The coil size of each coil icon can be modified by following these steps: Hold the **Return/Auto FS** button to enter the coil size editing mode. In this mode, a short underscore appears beneath the coil size number you intend to modify. Use the **Left/Pinpoint** or **Right/Auto GB** button to select the coil size number you wish to adjust. Then, make the desired modifications using the **Minus** or **Plus** button. To exit the coil size editing mode, press the **Return/Auto FS** button. After making these adjustments, you will see the selected coil size displayed in both the Main Detection UI and the Pinpoint UI.

When you connect a new coil, it's recommended to calibrate it by following these steps:

- Choose an unused coil icon to save the calibration parameters and adjust its coil size to match the actual coil.
- Hold the coil in the air, keeping metal and soil at least one meter away.
- If the LCD shows "**Ready to detect**", the stored parameters in the selected icon are good for the new coil and no further calibration is needed.
- If the LCD shows "**Hold ⊖ + ⊕ to calibrate**", hold the **Minus** and **Plus** buttons until coil calibration starts. Keep the coil in the air during the 25-second calibration process. Afterward, the LCD will display "**Ready to detect**".

7. Mic Volume

The control box has a microphone that captures ambient sounds, which can then be immediately played back through the headphone. This feature allows the user to simultaneously hear both the ambient sounds and detection audio. The Mic Volume setting allows the user to adjust the volume of the ambient sound playback. To use this feature, a headphone must be connected.

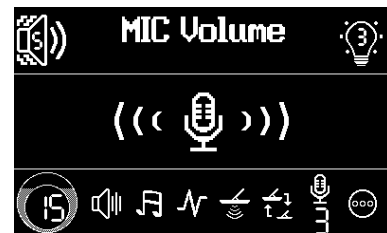

8. Miscellaneous Setting

Information about the power supply voltage, firmware version, and hardware serial number can be found in the Miscellaneous setting.

To perform a factory reset, hold both the **Minus** and **Plus** buttons for 3 seconds. After a factory reset, the coil profiles, including the coil names and calibration data, remain intact, so you don't need to set up your coils again.

You can switch between a dark or light display theme by holding down the **Backlight Adjust** button.

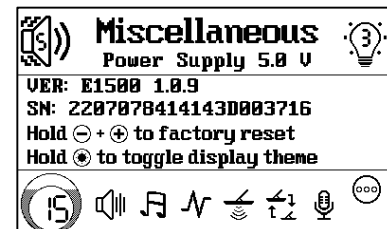

Software Upgrade Instruction

Upgrade the AlgoForce E1500 software for free by following these steps:

- First-time upgrades: download the AlgoDownloader from <https://algoforce.com.au/pages/downloads>.
- Download the latest software binary file from <https://algoforce.com.au/pages/downloads>.
- Turn off the control box. Connect it to your PC with a USB cable.
- Turn on the control box and it will automatically enter upgrade mode.

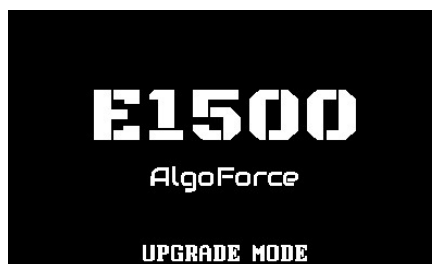
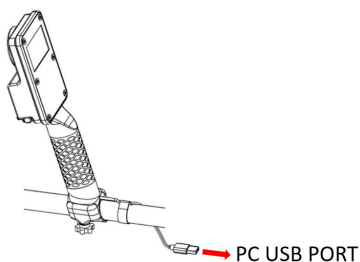

- Open AlgoDownloader and choose the appropriate port from the dropdown list. The 'Filter' option is selected by default, displaying only AlgoForce ports in the list. (Note: If the USB device driver is not already installed on your PC, the AlgoForce port will not be displayed. In this case, download the USB device driver (Driver.zip) from <https://algoforce.com.au/pages/downloads> and then follow the instructions in README.TXT in the zip file to install it.) Click 'Browse' to select the downloaded firmware binary file, and then click 'Update' to initiate the upgrade process (which takes approximately 10 seconds).

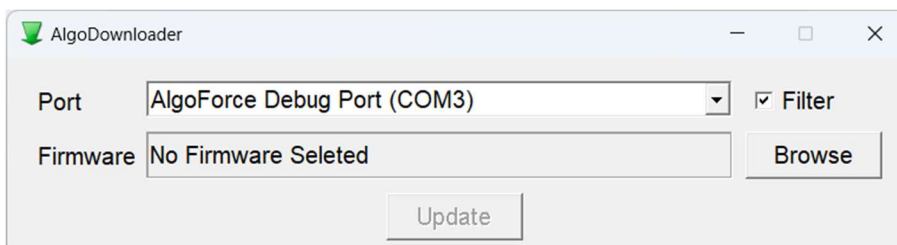

Note: The port number may vary on different PCs. Incorrect port selection will result in an upgrade error.

- Once the upgrade is complete, a window will pop up displaying 'Upgrade Successful.' After that, disconnect the control box from the PC.



- Connect the power bank to the control box and turn it on. Perform a factory reset.

Bug Report and Feature Request

AlgoForce highly values customer feedback as a crucial means of enhancing our products. To ensure a seamless feedback process, we encourage you to reach out to us directly via email at admin@algoforce.com.au. If you come across any bugs or have ideas for new features that could enhance your metal detecting experience, please send us an email with a detailed description of the issue or requested feature. Kindly include the hardware serial number and firmware version of your detector (located in the Miscellaneous setting) in your email. Our dedicated team of developers will promptly review your feedback and respond to you accordingly. We appreciate your contribution and look forward to working together to improve our products.

Safety and Care

To ensure safe use and longevity of your AlgoForce E1500, please follow these guidelines:

- Do not immerse the control box in water; it is not water-resistant.
- Clean the detector with a damp cloth, not solvents.
- Avoid extreme temperatures and keep it out of vehicles in extreme weather.
- The detector has small parts that could be a choking hazard, keep it away from children.
- Avoid contacting the detector with sharp objects to prevent scratches or damage.
- Handle the detector with care during transportation or storage to prevent violent vibrations or drops.
- Stay aware of your surroundings, especially when wearing headphones.
- The detector has an ambient sound awareness feature for headphone use, but does not guarantee all sounds will be heard.
- Before using in public areas, check local laws and regulations.
- Avoid disconnecting or connecting the coil to the control box after the unit has been powered up, as doing so could potentially damage the control box.
- The AlgoForce E1500 is specifically designed to operate with mono coils, utilizing the mono winding for both transmission and reception. While it's technically possible to plug in a DD coil, only the transmit winding would function as a mono coil, as the receive winding would remain open circuit. DD coils are not recommended for use with the AlgoForce E1500.
- When using coils larger and heavier than the NF 14"x9" Evo, the shaft may experience slight rotation and wobbling, despite tightening the spin locks.
- Over-tightening the spin locks could cause damage to them.

EMC Compliance

AlgoForce E1500 complies with the radiated emission limits for AS CISPR11:2017(Group 1, Class A). Class A equipment is equipment suitable for use in all locations other than those allocated in residential environments and those directly connected to a low voltage power supply network which supplies buildings used for domestic purposes.

Caution: AlgoForce E1500 is not intended for use in residential environments and may not provide adequate protection to radio reception in such environments.

Returns Policy

If you buy AlgoForce E1500 from a dealer, please contact the dealer for any returns. If you purchase AlgoForce E1500 from AlgoForce's Amazon store, please contact Amazon for any returns. If you purchase AlgoForce E1500 from AlgoForce's website (<https://algoforce.com.au>) or directly from AlgoForce Pty Ltd, please refer to the following paragraphs on this page regarding the returns policy.

Change of mind returns:

Subject to your rights under the Australian Consumer Law, if you wish to return an item because you have changed your mind about your purchase, AlgoForce Pty Ltd will offer you refund provided that:

- You return the item/s within 30 days of purchase and produce your original receipt.
- The item is in re-saleable condition, meaning that:
 - It is in its original packaging, including instruction manuals and all accessories; and
 - It is unworn, unused, unassembled, and in its original condition.
- You are responsible for the transportation costs to AlgoForce Pty Ltd.

If these requirements are not satisfied, AlgoForce Pty Ltd reserves the right not to offer refund for change of mind returns.

Other Returns:

In addition to any other rights you may have under the Australian Consumer Law, AlgoForce Pty Ltd will accept product returns and provide you with the choice of an exchange (where feasible) or a refund where:

- The product is faulty or is not of acceptable quality; or
- The product is not fit for its intended purpose; or
- The product does not match the sample or our description.

For all returns, you must return the item/s within 30 days of purchase and produce your original receipt. When returning a product, you will be asked for information that is relevant to your return, or to satisfy legislative requirements. If you do not provide this information, then we may be unable to process your return. AlgoForce Pty Ltd reserves the right to assess the condition and age of returned goods prior to providing an exchange or refund. This may result in an exchange or refund being refused. Refunds will be processed using the payment method stated on your original receipt. AlgoForce Pty Ltd reserves the right not to offer an exchange or refund where the item fault is a result of misuse or neglect.

If you need to return an item, please contact us at admin@algoforce.com.au with your order number and details about the product you would like to return. We will respond quickly with instructions on how to return items from your order.

Warranty Information

If you buy AlgoForce E1500 from a dealer, please contact the dealer for any warranty information and issues. If you purchase AlgoForce E1500 from AlgoForce's Amazon store, from AlgoForce's website (<https://algoforce.com.au>), or directly from AlgoForce Pty Ltd, please refer to the following paragraphs on this page regarding warranty information.

The control box, stem, and arm cuff of the AlgoForce E1500 are covered by a 2-year warranty for any manufacturing issues. The warranty starts from the date of purchase and can be transferred. It does not cover damage resulting from an over or reverse voltage supply, misuse, abuse, modification, alteration, water damage, accidents, or neglect. Tampering with the control box will void the warranty. If a coil is included with the product, it will be under warranty from the coil manufacturer and not from AlgoForce Pty Ltd.

If you need repairs or warranty service for your AlgoForce E1500 (excluding the coil), please follow the steps listed to ensure prompt and efficient service.

1. Send an email to admin@algoforce.com.au with the following required information. You will receive a response with a repair or warranty service number (RWSN).

First Name: _____ Last Name: _____

Serial Number: _____

Detailed Description of the Problem: _____

Return Shipping Address: _____

Billing Address (if not the same as the return shipping address):

How do you wish the item returned after repair or warranty service (please select one):

AusPost Standard AusPost Express

2. Send the control box, accompanied by a brief note with the RWSN, to:
PO BOX SUITE 393, GLENSIDE SA AUSTRALIA 5065
3. Once received, AlgoForce Pty Ltd will diagnose the issue and send you an email with a quote, which may include the cost of return postage if either AusPost Standard or AusPost Express was chosen in step 1. If the item is not covered under warranty, the quote may include the cost of repairs. AlgoForce Pty Ltd will return the repaired item after payment of any amount specified in the quote.

Note:

- The detector owner is responsible for transportation costs to and from AlgoForce Pty Ltd.
- Repairs come with a 90-day warranty.
- Please be aware that user-stored data in the detector may be lost during the repair process.
- Goods presented for repair may be replaced by refurbished goods of the same type rather than being repaired. Refurbished parts may be used to repair goods.

Specifications

Ultra-Fine PI Technology	✓
Conductive Target ID	0-99
Fundamental Transmit Frequency	1500 Hz (adjustable)
Coil	<p>* Mono</p> <p>* Compatible with GPX 4500/5000 aftermarket mono coils</p> <p>* The Nugget Finder 8"x6" Advantage Sadie coil is recommended for outstanding ultra-fine gold detection and excellent EMI immunity. It is also recommended in the Ultra-Fine Gold detection mode for finding fine jewellery, coins, and other treasures on the beach.</p> <p>* The Nugget Finder 14"x9" Evolution Mono coil is a top choice for comprehensive coverage of gold nuggets of all sizes in various soil conditions. It is also recommended in the Normal Gold detection mode for finding deep jewellery, coins, and other treasures on the beach.</p>
User Coil Calibration	✓
LCD	B/W 2.7" 400x240 pixels
Backlight Adjust	✓
Mic for Ambient Sound Awareness	✓
Handle Vibration	✓
Loudspeaker	✓
3.5mm Headphone Socket	✓
Ground Balance	Automatic, dual ground balanced channels
Sensitivity Control	✓ (Visual detection threshold for easy sensitivity control)
Audio Threshold Control	✓
Audio Tone Control	✓
Frequency Scan	Automatic and Manual (Visual representation of noise levels across all frequencies in one graph for easy manual frequency selection)
Volume Control	✓
Stem Length (Adjustable)	Fully extended: 145cm Collapses to 65cm
Weight	840g without coil or powerbank
Power Source	External 5V DC USB powerbank
Average Current Consumption	700mA
Warranty	2 years, Limited Part/Labor

Release Note for Software V1.0.9

Software version 1.0.9 was released on 08/04/2024, introducing two additional audio settings within the pinpoint (non-motion) mode: C.ID 5 Tones and C.ID 100 Tones. The original pinpoint audio setting is named C.ID Pinpoint, with 'C.ID' standing for Conductivity Target ID. Users can seamlessly switch between audio settings by briefly pressing the **Right/Auto GB** button while in pinpoint mode.

C.ID Pinpoint:

As in previous software releases, in C.ID Pinpoint audio setting, audio pitch correlates with signal strength, with higher pitches indicating stronger signals. Tailored for precise pinpointing of target locations.

C.ID 5 Tones:

Audio pitch is determined by conductivity target ID, providing distinct audio feedback for different target ranges. Conductivity target ID ranges 0-19, 20-39, 40-59, 60-79, and 80-99 correspond to audio pitches of 330Hz, 490Hz, 650Hz, 810Hz, and 970Hz, respectively.

C.ID 100 Tones:

Each conductivity target ID is associated with a unique audio pitch ranging from 250Hz to 1042Hz. Higher conductivity target IDs produce higher audio pitches, facilitating differentiation of targets.

In C.ID Pinpoint audio setting, users retain the ability to adjust the audio threshold through the Threshold setting, consistent with previous software releases. In both C.ID 5 Tones audio setting and C.ID 100 Tones audio setting, the audio threshold is fixed at zero. This ensures ease of differentiation between conductivity target IDs solely based on unique audio pitches, eliminating potential confusion with the audio threshold.

These enhancements aim to provide users with greater flexibility and improved target identification capabilities.

Release Note for Software V1.0.8

Software V1.0.8 was released on 13/02/2024. The following changes were made with respect to the previous software V1.0.7:

1. The activation time for a long key press function has been reduced from 1.5 seconds to 0.7 seconds. For example, the time duration between pressing and holding the ground balance key and the commencement of actual ground balancing is now 0.7 seconds, as opposed to 1.5 seconds. Other functions requiring a long key press are similarly affected, including vibration adjustment and auto frequency scan.
2. In version 1.0.7, Pinpoint mode and the main detection mode shared the same volume and vibration controls. With the introduction of v1.0.8, Pinpoint mode now features independent volume and vibration controls separate from the main detection mode. Users can customize their preferred volume and vibration settings in either mode. Furthermore, the volume and vibration settings in both modes are saved during power down for convenience.

08/04/2024