



Tanzite

STONEDECKS

The Rainier Collection

OUTDOOR Installation Manual and Warranty

Tip: Read this manual BEFORE you design the deck.

For indoor use refer to the Rainier Collection INDOOR Installation Manual.

Contents of this Manual

	Page
Disclaimer.....	3
The Rainier Collection.....	4
What's Included in a Rainier Kit.....	5
Installation Quick Start Guide.....	6
Versatile Installation.....	7
Rainier Stone Flooring Blocks.....	8
Cutting Rainier Stone Flooring Blocks.....	9
Rainier Stone Colors.....	10
Stone Flooring Layout Ideas.....	11
Lateral Gasket & End Gasket.....	12
Aluminum Edger.....	14
Aluminum Edger and EPDM detail.....	16
Fascia Board and Clips.....	17
Building a New Wooden Deck.....	18
Post, Beam and Joist Sizing.....	23
Building Plywood Steps.....	25
How to Install Railings.....	27
Covering an Old Wooden Deck.....	28
Covering a Vinyl Deck.....	30
Installing the EPDM Membrane.....	31
Installing Stone Flooring Blocks.....	33

	Page
Rooftop Installation.....	36
Concrete Resurfacing.....	40
Paving Resurfacing.....	43
Ground Installation.....	44
General Advice for Installing, Maintaining and Repairing Tanzite.....	47
Problems and Solutions.....	50
Sustainability.....	52
On site/ Handover Checklist.....	53
Tanzite Warranty.....	55
Tanzite Returns Policy.....	60

Rainier is also perfect for
indoor use. Please refer to:

The Rainier Collection
INDOOR Installation Manual

Disclaimer

This installation manual is provided for informational purposes only. The information contained herein is intended to provide general guidelines to simplify your project.

Tools, products, materials, techniques, building codes, and other regulations continually change, so Tanzite assumes no responsibility for the accuracy of the information contained herein and disclaims any liability for omissions, errors, or the outcome of any project.

Diagrams are approximations, not drawn to scale.

It is the responsibility of the installer or user to ensure compliance with all applicable laws, rules, codes and regulations, and manufacturers specifications, in relation to their project.

The installer or user must take appropriate safety precautions to minimize the risk of harm to themselves or anybody else.

It is the responsibility of the homeowner to properly maintain and insure their project.

If there is any doubt regarding any element of a project, you should consult a licensed professional.

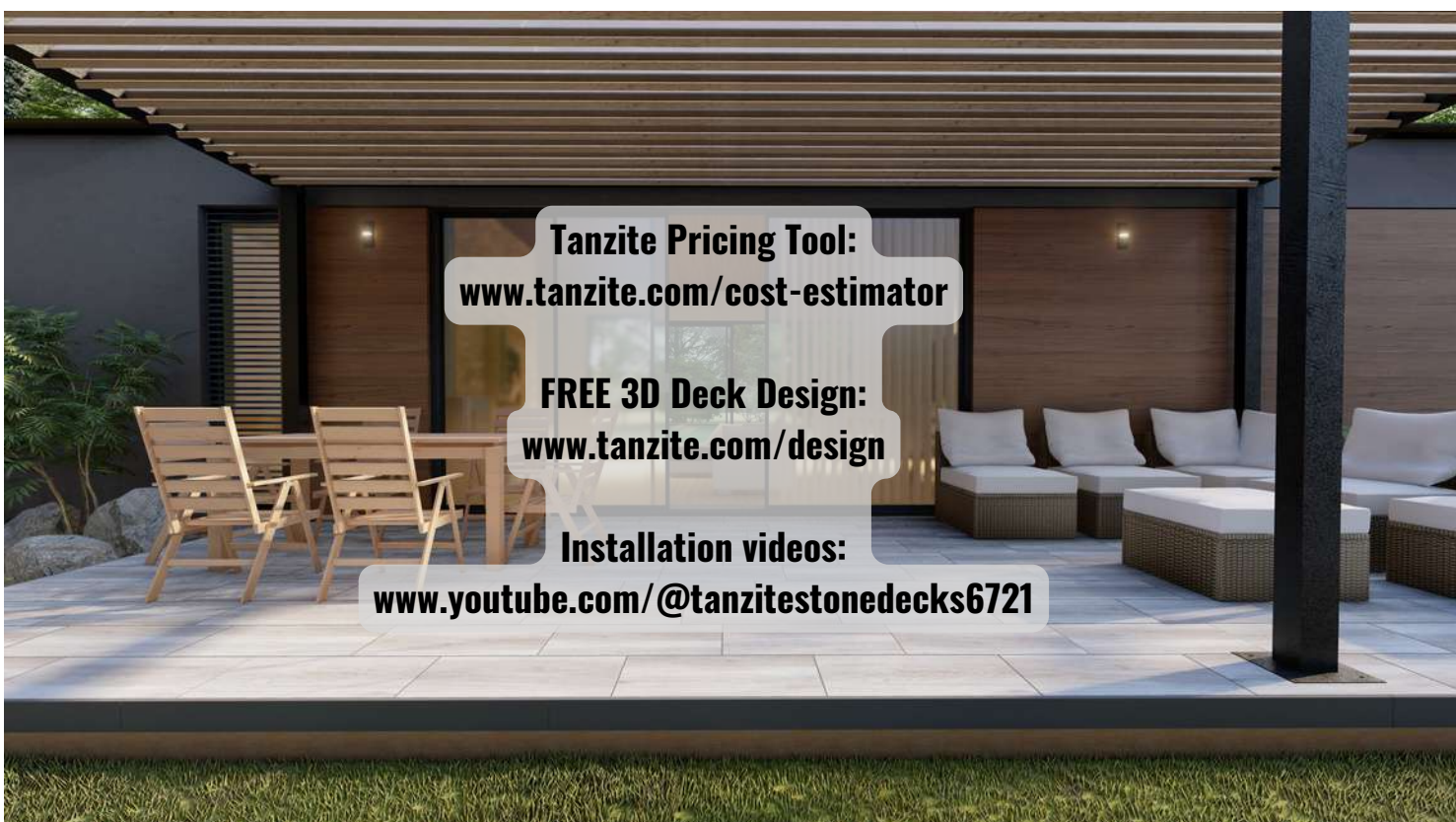



The Rainier Collection

Tanzite

STONEDECKS

Tanzite's Rainier Collection is:

- A low-maintenance, water-resistant, stone DECKING FINISH for most deck structures.
- An easy-install, grout-free, durable, INDOOR STONE FLOOR finish.

The Rainier stone flooring blocks are held in place using discreet rubber lateral gaskets and end gaskets so there are no visible screws (for decking), and no grout (for indoor use). Therefore, it is incredibly easy to install, adjust, or even take with you to your next home. Plus you're able to walk on each piece immediately after it's installed!

Tanzite stone pieces are precision manufactured using extreme pressure and heat. The dimensions are precise and consistent, so it's easy to install to a high standard.

Easy to install. Durable. Beautiful. Seamless connection from indoors to outdoors reducing wastage too.



The many advantages of Tanzite stone as an exterior decking:

- Lifetime warranty*
- Low-maintenance
- Scratch-proof
- Use ice-melter and salt
- Fade-free
- Water-resistant: Mold or mildew won't damage it
- Easy to clean: Pressure washing won't damage it
- Made sustainably without plastics or harmful chemicals
- Cleaning chemical resistance
- Stain-proof
- Fire-proof and melt-proof from embers or BBQ grease
- Covers existing decking or concrete surface
- Can add creative inlay designs, including curves
- Easy to repair
- Free-floating
- Stays cooler in the sun (takes longer to warm up than composite, timber and tile products), and then stays warmer for longer at the end of the day.
- The built-in underlay also helps it to stay warmer for longer at the end of the day.

What's Included in a Rainier Decking Kit?

Tanzite
STONEDECKS

Rainier kits for decking generally include the following parts (unless you specify otherwise):

- Rainier stone flooring blocks
- End and Lateral gaskets
- Aluminum edgers and fasteners
- EPDM waterproof membrane
- Fascia boards, clips, and fasteners

Tools for safety:

- Eye protection
- Hearing protection
- Dust mask
- Gloves
- Boots

Additional Tools for Tanzite installation:

- Diamond saw blade
- Grease pencil
- T15 drill bit
- Glass/tile drill bit and/or diamond hole saw



Tools for framing:

- Tape measure
- Level
- Square
- Chalk line
- Pencil
- Plumb bob
- Extension cord
- Saw: miter saw, circular saw, hand saw, etc
- Drills and bits
- Hammer and nails
- Ladder

For indoor installation
refer to:

**The Rainer Collection
INDOOR Installation
Manual**

NEW DECK (p.18):

- Posts
- Beam
- Ledger board
- Joists
- Blocking
- Plywood
- Membrane

EXISTING WOOD DECK (p.28):

- Add slope to deck
- Sand down, or plane, the deck boards
- Membrane

EXISTING VINYL DECK (p.30):

- Install over vinyl (can add membrane)
- Remove vinyl and install membrane

INSTALLING EPDM MEMBRANE (p.31):

- EPDM supplied to your deck size
- Seam a joint if needed
- Run EPDM behind the decking siding and house flashing

ROOF TOP (p.36):

- Lay a protection fabric

EXISTING CONCRETE (p.40):

- Level as needed though no need to repair cracks

EXISTING PAVING STONE (p.43):

- Screed with fine crushed rock (or sand)

ON THE GROUND (p.44):

- Remove topsoil
- Compact the ground
- Install compacted gravel
- Screed with fine crushed rock (or sand)

LAYING TANZITE (p.33):

- Install edge restraint
- Cover with underlay foam, if needed
- Lay Tanzite stone
- Install end gasket
- Install lateral gasket
- Caulk joint next to house

Installation guides and videos are available at:
www.tanzite.com
www.youtube.com/@tanzitestonedecks6721

Our team is here to answer your installation questions.

Call us on
1-833-478-6633.

BEFORE designing your deck, we recommend reading the manual from start to finish because there is essential information throughout the manual that can make ALL the difference to the success and efficiency of your project. This quick start guide gives a brief overview of the installation process so that you read the manual in detail, within the context of the whole process.

Installation on to decking frame:

1. Install piles and posts or foundation to support the deck beam. (p.18)
2. Install ledger board to the house, or use a second set of piles to support another beam. (p.19)
3. Select joists that are straight and even to each other. (p.20)
4. Install joists so the plywood sheets all finish on joists. (p.20)
5. Install blocking(bridging) every 8ft(2.4m) along joist spans, at every railing post and where stair stringers connect to deck frame. (p.20)
6. Install studs for fascia every 2ft(600mm) on center, and timber bracing. (p.22)
7. Install plywood sheet of correct thickness for joist centres. (p.22) If using fascia or other deck siding, the plywood overhangs the rim joist by 1"(26mm), with 1"x2" batten fixed horizontally beneath it. (p.16)
8. Install stair stringers, with plywood on the steps. (p.25)
9. Install EPDM (Purely to make it waterproof so as to protect timber below- ie. NOT needed if you don't have timber or any other reason to make it waterproof). (p.31)

Installation on the ground (p.44):

1. Excavate minimum 6"(150mm) and compact ground.
2. Install a foundation of compacted road-crush or similar, minimum 6"(150mm).
3. Lay a minimum of 1 1/4"(32mm) crushed limestone or levelling sand.
4. Lay Rainier pieces as desired.
5. Install landscaping spikes, minimum 8"(203mm), into snapedge, spaced at a minimum of 24" (610mm).

Tanzite stone flooring blocks and fascia boards:

1. Install fascia clips and boards, on stair and deck sides. (p.17)
2. Install aluminum edger. (p.14)
3. Install Rainier stone flooring blocks, with lateral gaskets and end gaskets. (p.12)
4. Install railing if applicable. Drill Tanzite using a regular drill with a glass/tile/porcelain bit. (p.27)

Rainier stone flooring block dimensions INCLUDING 1/6" (4mm) lateral gasket:
1' x 2' x 3/4" (305mm x 610mm x 19mm)

The Tanzite Rainier Collection system utilizes just one size of stone flooring blocks for efficient and enjoyable installation.

Rainier stone flooring blocks come with the lateral gasket fitted, and cushioning material glued to the underside. They are connected to neighbouring flooring blocks using lateral gaskets and end gaskets.





CUT AND DRILL OUTSIDE OR IN A WELL VENTILATED AREA

With every cut you produce **TWO** useable pieces of stone.

- Tanzite can be cut with a regular saw using a diamond blade.
- Using a continuous thin-rim diamond blade will make a cleaner cut, ideally a glass/ tile/ porcelain blade.
- A hand-held grinder (angle grinder) with a diamond blade works well for detailed cuts, such as fitting a piece around a gas pipe.
- If you're making a lot of cuts, use a wet tile saw.
- After making each cut, round the edge using a diamond sanding pad.

- ✓ Reduce airborne dust with water and adequate ventilation.
- ✓ Always use appropriate personal protective equipment including respiratory, eye, sound and vibration protection.
- ✓ If dry-cutting, wear an approved dust mask or respirator.

Ripping (lengthways cut)

The stone is specifically designed so that when you rip it as shown, you create a new edge groove. Depending on the width that you require, you may be able to rip various pieces from just one stone flooring block. Another efficiency saving.

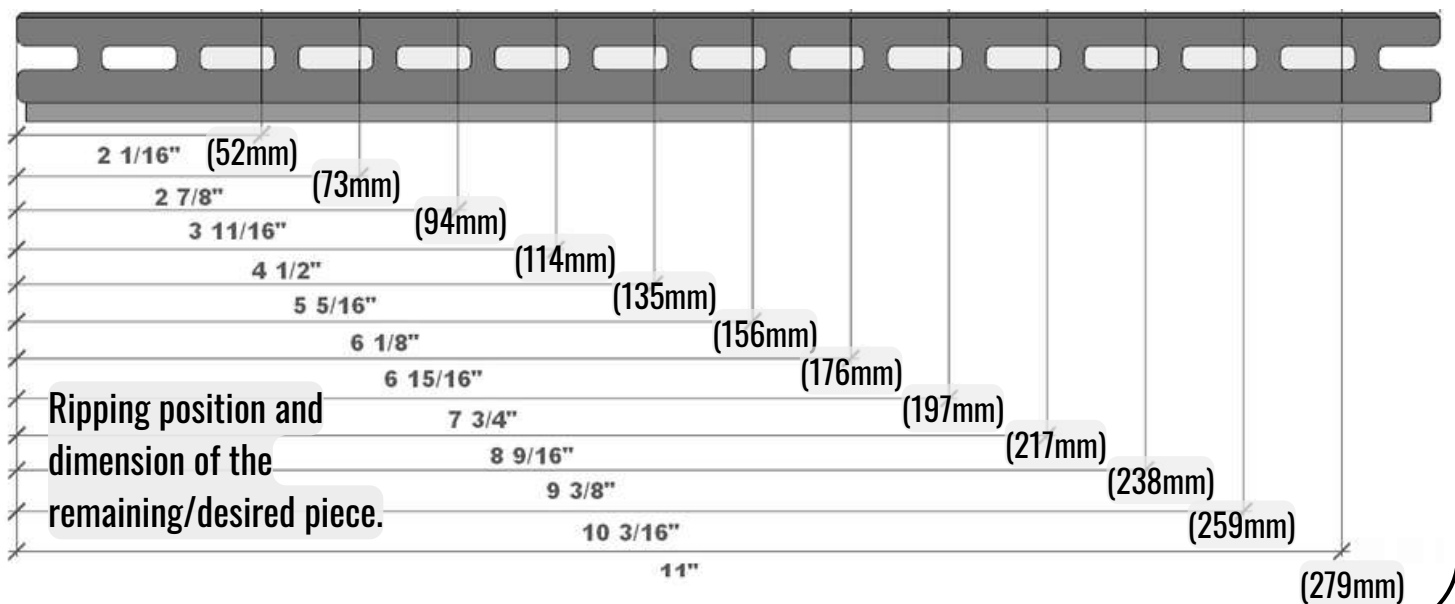

Rainier Stone Colors

Tanzite

STONEDECKS

Each stone color is supplied with gaskets which are colored to reduce their visibility and further enhance the appearance of the stone.

Aged Teak



Brown gaskets



Travertine



Warm grey gaskets



American Walnut



Brown gaskets



Canyon Brown



Brown gaskets



Sierra Grey



Cool grey gaskets



Slate Black



Black gaskets



Carrara Marble



White gaskets



Driftwood



Cool grey gaskets



Simply, choose your pattern, choose your starting corner, and let them fall into place. Cut a stone flooring block when you reach the end of a row, keeping the offcut for use on the next row, or later on.

Whichever pattern you use, you can also incorporate a border/ 'picture frame' by first laying a full row of stone all the way around the floor edge. You can use either mitered corners or a butt joint at the corners. Once you've laid your border you then 'fill it in' row after row, following whichever pattern you choose.

Get creative- easily introduce different colors and patterns. The gasket system makes it very easy to lay stone out in a dry-run. Just remove the gaskets and place them to one side, whilst you carefully lay out/ try out different patterns.

You can also use our free design service to see how different patterns will look, and how much stone you will need to order.

Here are some classic patterns to get you started:

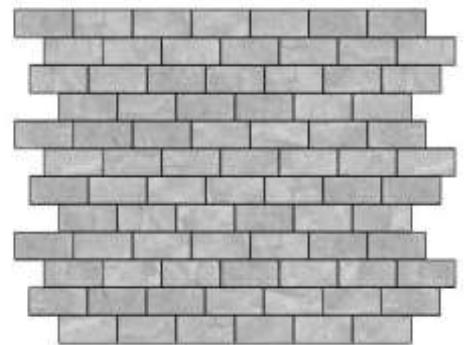
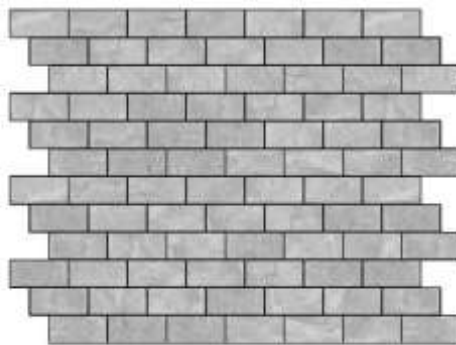
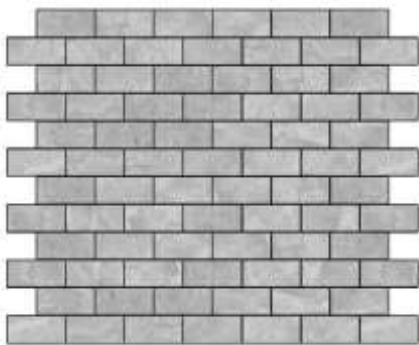
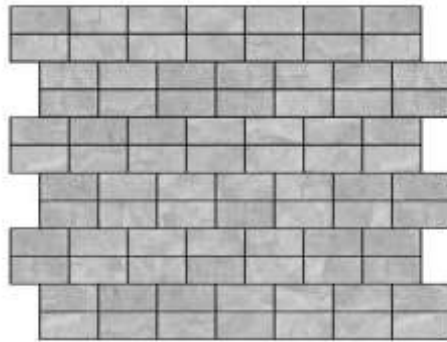
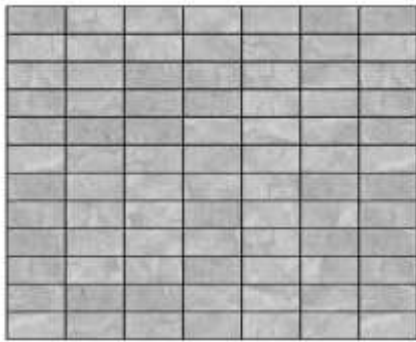

Rubber Lateral Gasket & End Gasket

Tanzite
STONEDECKS

Lateral gaskets simply push into the grooves of adjacent rows of stone flooring blocks, and end gaskets slot easily into the ends of the stone flooring blocks that form a row.

Gaskets come in five colors. We automatically supply the color that enhances your selected stone color.

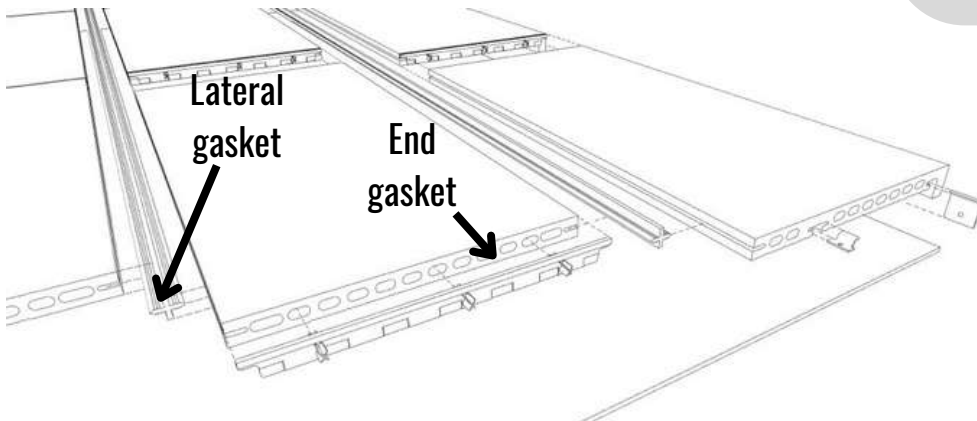

Lateral gaskets look like a cross in profile, with a ribbed arm that goes into the groove of the neighbouring stone flooring blocks, and a 4mm wide upward and downward fin that provides flexible and cushioned spacing between them.



It is simply pushed into place and holds without any need for adhesive.

If you need to make an adjustment, or lift flooring blocks for any reason, the lateral gasket is easily pulled out, with no need to damage it in the process, so that it can easily slot back in.

Lateral gasket(white)



End gaskets fit into the flooring block ends, located with three pegs for each connecting flooring block.

Lateral gaskets and end gaskets are easy to cut to the length required, using only a builders knife.

Packets of additional gaskets can be ordered in any of the five gasket colors. In each packet there is:

PRO-TIP: To install the lateral gasket, run it through a wet sponge - the water lubricates the gasket so that it glides more easily along the groove of the stone flooring blocks.

- 5 x End Gasket AND 5 x Lateral Gasket

Rubber Lateral Gasket & End Gasket

Tanzite
STONEDECKS

Gaskets come in five colors.
We automatically supply the color that enhances your selected stone color.

White



Warm Grey



Cool Grey



Brown



Black



Packets of additional gaskets can be ordered in any of the five gasket colors. In each packet there is:

- 5 x End Gasket AND 5 x Lateral Gasket

PRO-TIP: To install the lateral gasket, run it through a wet sponge - the water lubricates the gasket so that it glides more easily along the groove of the stone flooring blocks.

Aluminum edger:

- Can be ordered in matte black or gloss white.
- Comes with screws in matching color.
- Creates a neat edge to deck and stairs.
- Easy to cut and fit.
- For easy stone flooring block installation.
- Covers the stone flooring block edges.
- Simplicity, accuracy, durability.

The aluminum edger provides a neat finish around the edge of the deck, and makes it easy for the installer to achieve a truly impressive finish.

The aluminum edger is precision designed so that it is easy to fit- simply screwed onto the rim joist. The stone flooring blocks fit easily and snugly into the space provided.

The drip edge at the bottom of the aluminum edger takes water out and away from the fascia below it.

Create any angle for the corners of your deck:

1. Push the lateral gasket into the aluminum edger.
2. Cut off the spare wing of the lateral gasket.
3. Apply a bead of exterior caulking between the stone flooring block and the gasket.



Matte black edger



Gloss white edger

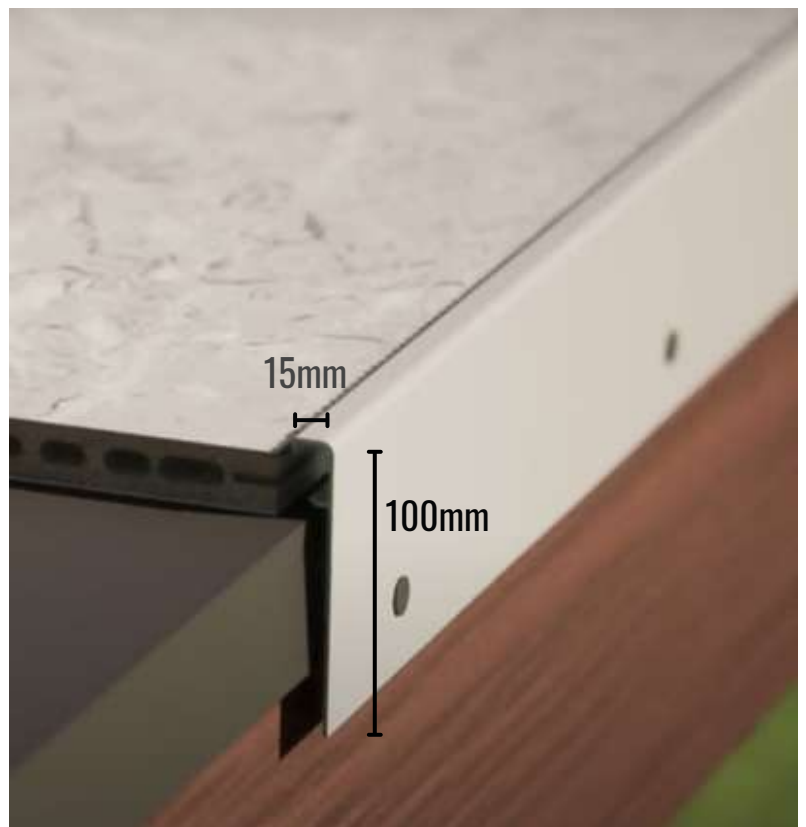



DESIGN THE DECK DIMENSIONS TO ALLOW FOR OVERHANG AT RIM JOIST

1. Lay your plywood deck to overhang the rim joist to match your 1" (by 2") batten.
2. Fit your 1"x2" batten snugly underneath the plywood overhang.
3. Lay your EPDM, leaving it long- you will cut it back once the aluminum edger is in place.
4. Fix the aluminum edger, securely fixing to the batten.
5. Place your first row of stone flooring blocks to ensure the edger is at the perfect height.
6. Cut the EPDM with scissors or a knife so that it matches the bottom edge of the aluminum edger without being visible- This way, water that flows over the EPDM will NOT go behind the fascia.

NOTE: It is preferable to overhang the plywood as this ensures that the surface onto which you lay the EPDM and stone is straight. However, for an existing plywood deck, simply use a 1"x3" piece of timber to create the required overhang for the fascia and the solid backing for fitting the aluminum edger.

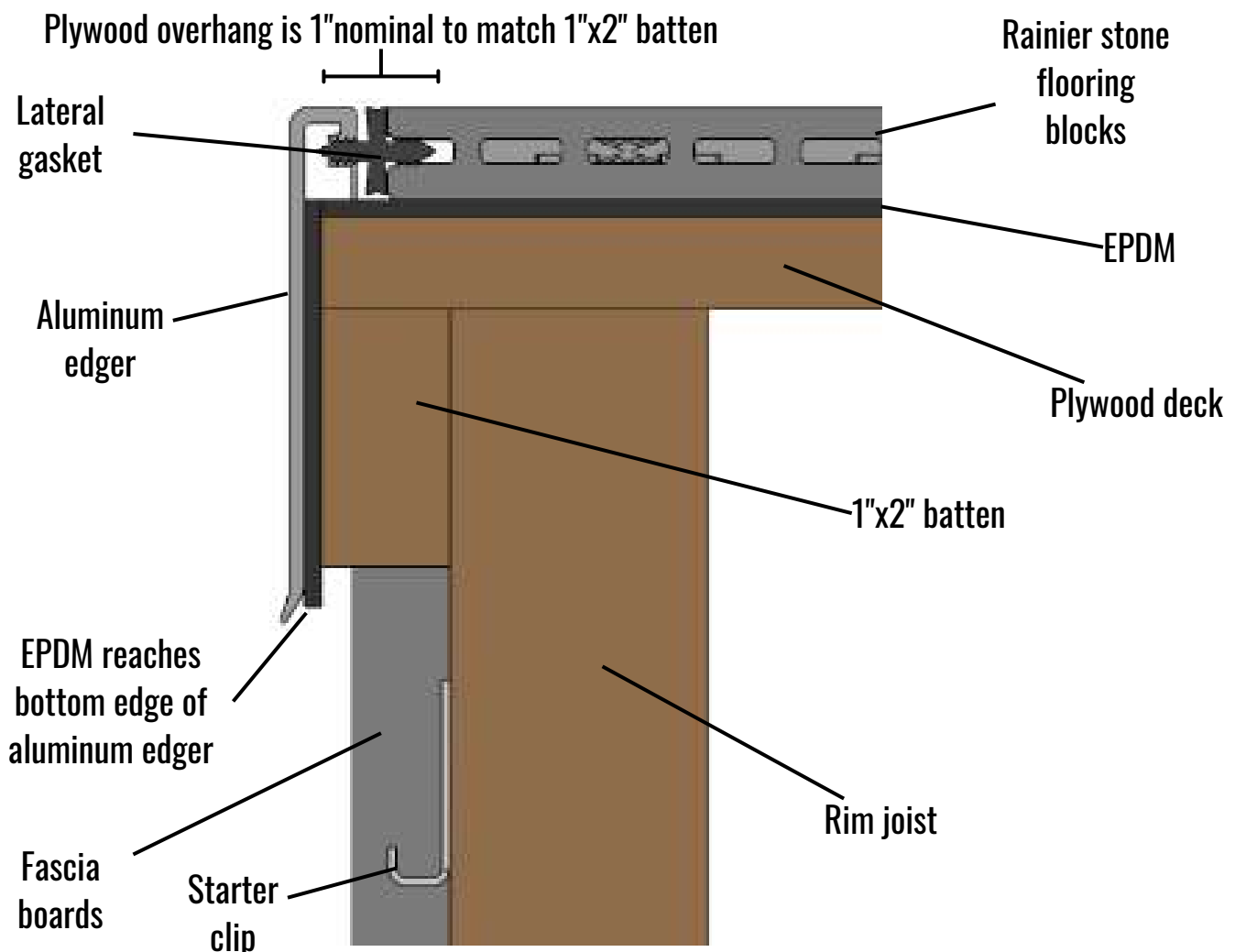

Fascia board:

8' x 48" x 3/4"
(205mm x 1219mm x 19mm)

Fascia board is used on vertical sections, such as the sides of the deck or stairs.

It is held in place using starter clips and double fascia clips that slide into the hidden grooves of the board.



Fascia clips:

All clips are made of 316 stainless steel and come with a 25mm 316 stainless steel screw.

Starter clips are installed at the very top of the rim board to support the upper groove on the first (or only) row of fascia boards.

If there is only one row of fascia boards, a second starter clip is installed to support the lower groove of the fascia board.

Starter clips also hold the lower groove on the bottom fascia board, however many rows of fascia board you have.

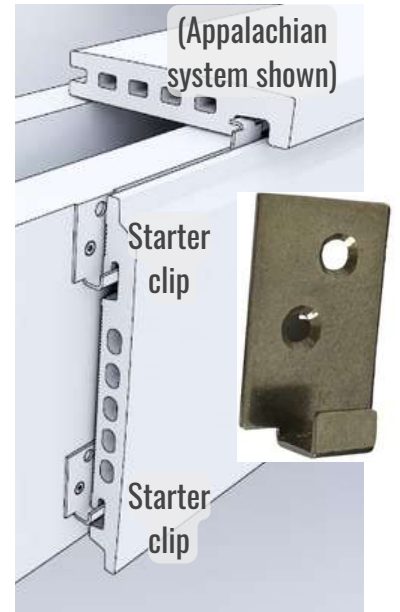

If more than one row of fascia boards is required, **double clips** are installed which hold the lower groove of the top board and the upper groove of the fascia board beneath it.

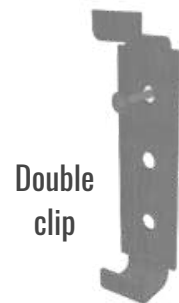

The process is followed downwards, reducing installation time and ensuring accurate and consistent vertical spacing from one board to the next.

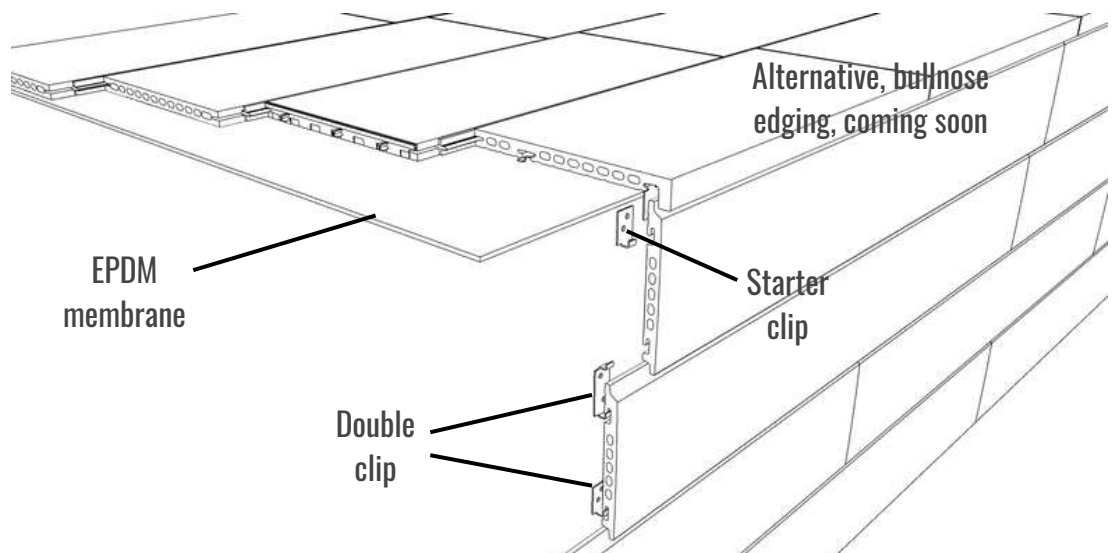

How to Install Tanzite Rainier

Building a New Plywood Deck (Page 1 of 5)

Tanzite
STONEDECKS

Start with a solid foundation with good piles that will support your posts.

Build a beam of the length you will need. Use the chart on page 18 to determine the minimum beam size needed for your post spacing. We recommend building a triple-beam fastened together every 16" (406mm) and glued.

Determine the height you will need for each post. Ideally, install the beam directly on top of the posts so that the posts naturally take the weight of the beam, and therefore the decking.

Secure the beam to the posts. Regulations in most areas require that hardware is used in combination with fasteners to hold the beam to the posts.

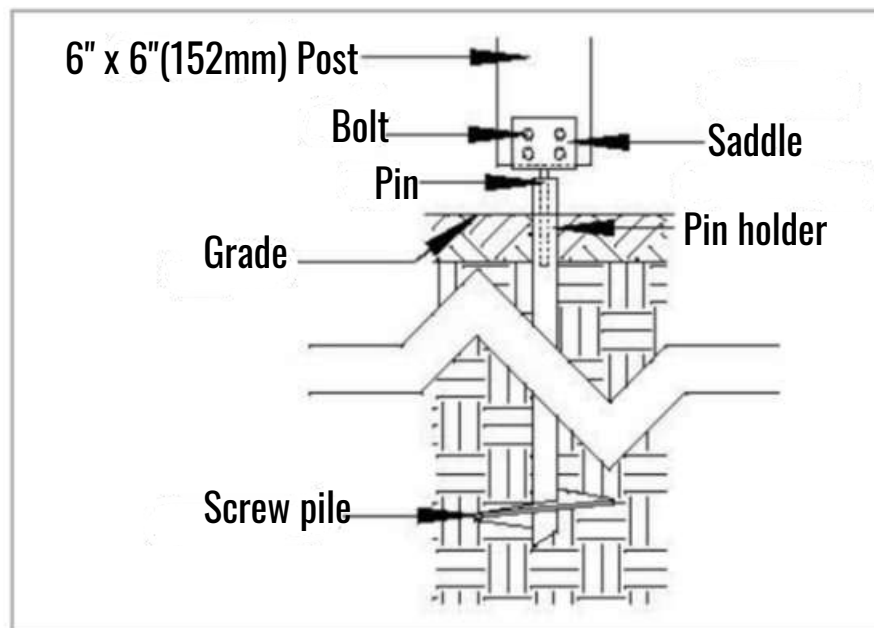

How to Install Tanzite Rainier

Building a New Plywood Deck (Page 2 of 5)

Determine the desired finish height of the deck.

Calculate how far below this finished height you should attach the ledger board, allowing sufficient space for:

The plywood thickness:
5/8" or 7/8"

+

2mm for EPDM membrane

+

19mm for the stone flooring block

Typically this would be 1-3/8" or 1-1/2" lower than the desired finished height.

Install a ledger board onto the house wall, or use posts and a beam near the house wall if your deck will not be attached to the house.

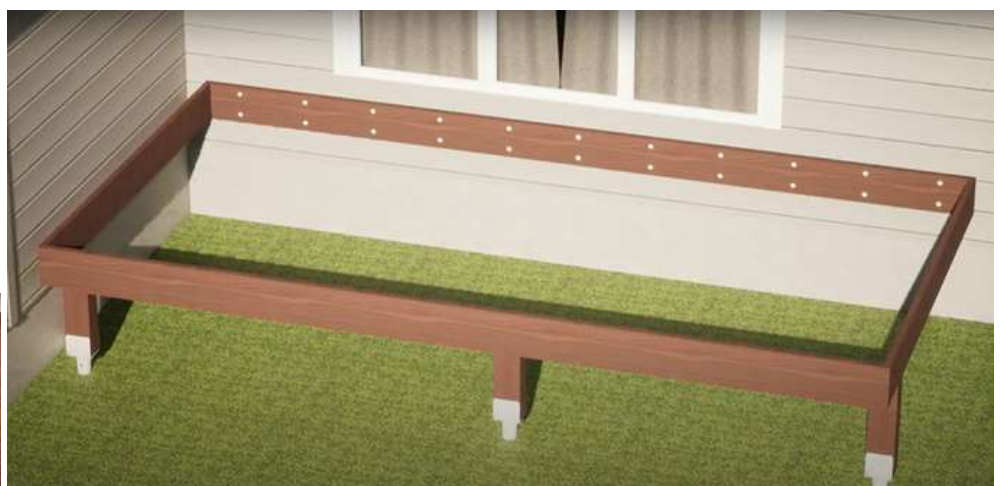

How to Install Tanzite Rainier

Building a New Plywood Deck (Page 3 of 5)

Tanzite
STONEDECKS

Place joists, crown side up, every 12"(305mm), 16"(406mm) or 24"(610mm) on centre.

For joists at 12"(305mm) centres, use plywood that is 1/2"(12mm) thick.

For joists at 16"(406mm) centres, use plywood that is 5/8"(15mm) thick.

For joists at 24"(610mm) centres, use plywood that is 3/4"(18mm) thick.

Use joist hangers to attach to the ledger board and hurricane clips to attach them to the beam.

Use a double joist wherever stairs will be attached.

The joists should slope away from the house at least 1%. For every 100" (1m) horizontal it should fall by at least 1" (1cm).

PRO TIP: When your joists arrive on site, lay them all next to each other on their thin edge with any crown/arch facing upwards. Select the flattest tops to be your joists, and the worst to be blocking (bridging) and bracing.

Now, place the selected joists next to each other, switching them around to match their tops as closely as you can between neighbouring joists. With joists installed, use a planer or surform to further reduce high points. If needed, plane the joists even to each other.

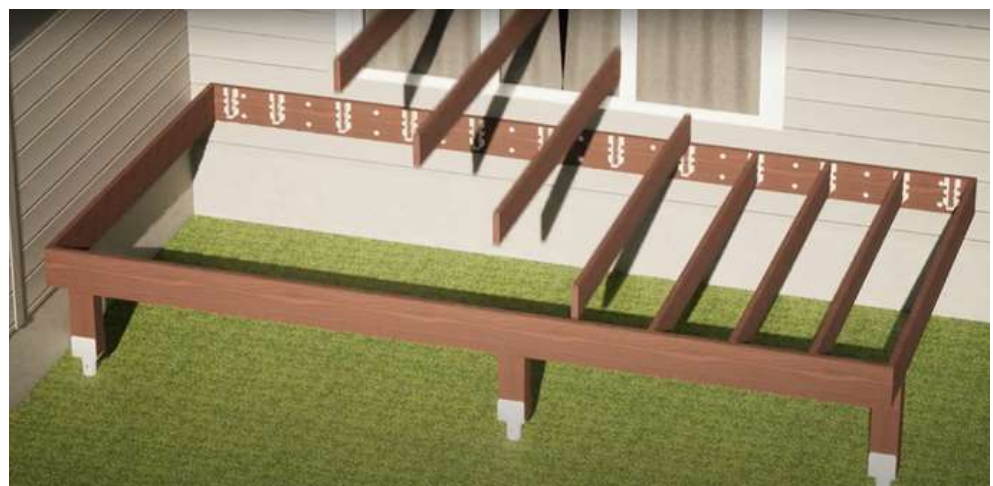
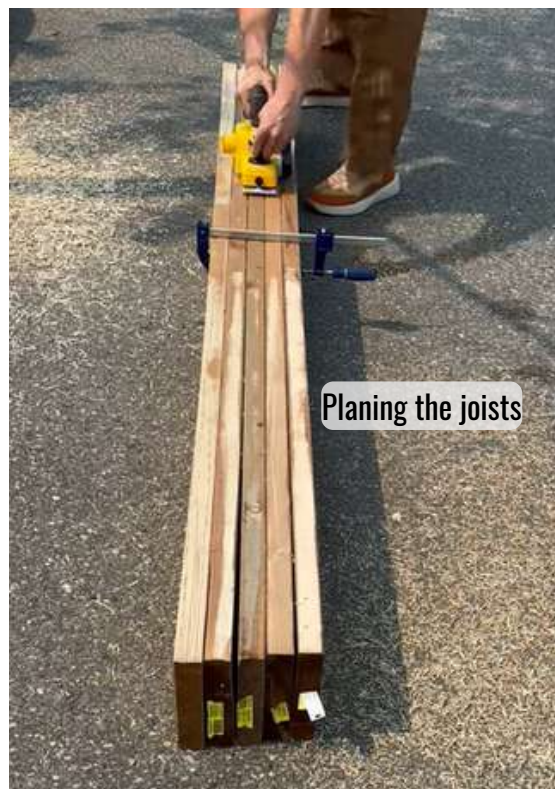

How to Install Tanzite Rainier

Building a New Plywood Deck (Page 4 of 5)

Tanzite
STONEDECKS

Make sure your joists are installed evenly to create a flat surface.

Install blocking mid-span of your joists, or at least every 8 feet (2.4m).

Then also add blocking wherever a railing post, or stairs, will be attached.



How to Install Tanzite Rainier

Building a New Plywood Deck (Page 5 of 5)

Tanzite
STONEDECKS

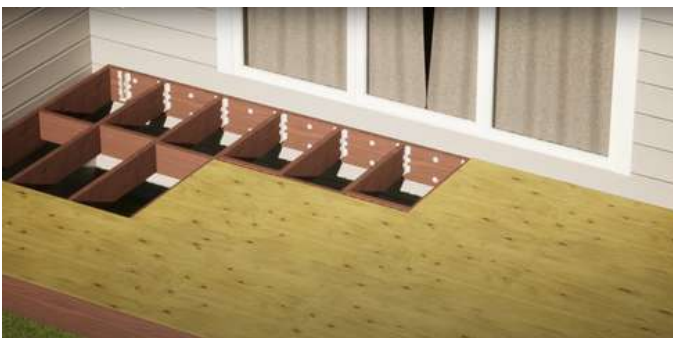
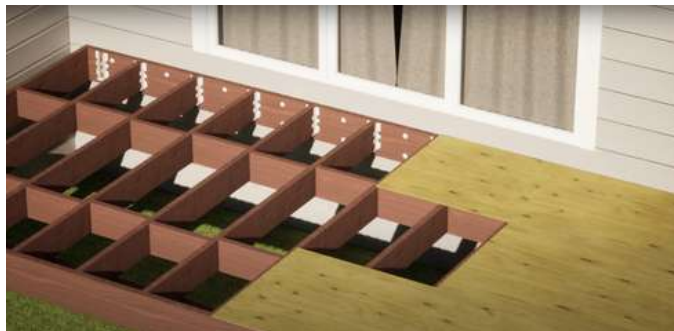
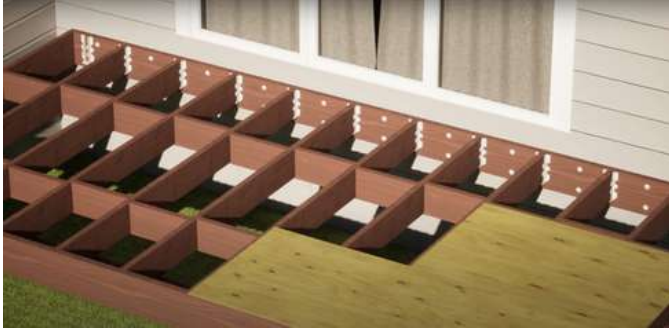

Now cover the surface with plywood, offsetting each sheet by 1/2, and ensuring the ends finish on a joist.

Plywood should overrun the rim joist in all directions by 1" (26mm) which will provide space for the installation of fascia around the deck sides, and Rainier stone flooring blocks on the step risers of stairs. As per diagram on page 16:

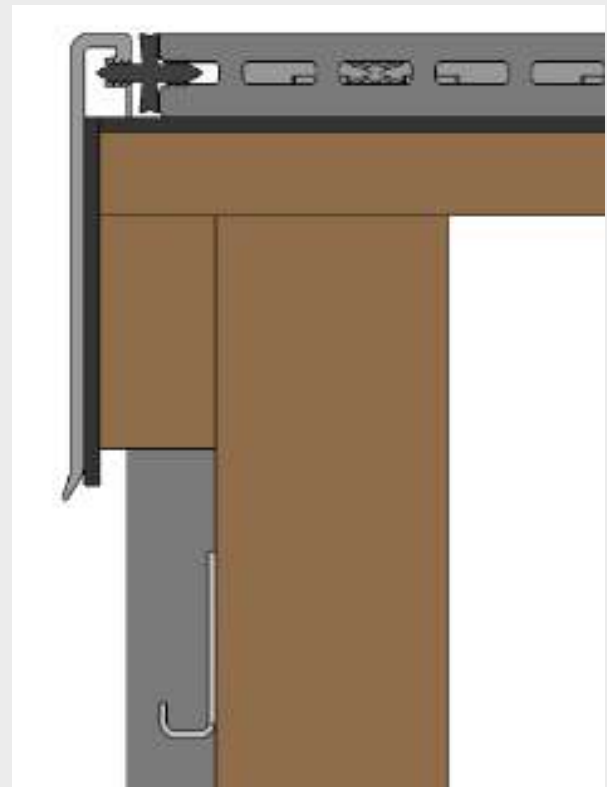

Designing a Plywood Deck Frame

Post, Beam and Joist Sizing (Page 1 of 2)

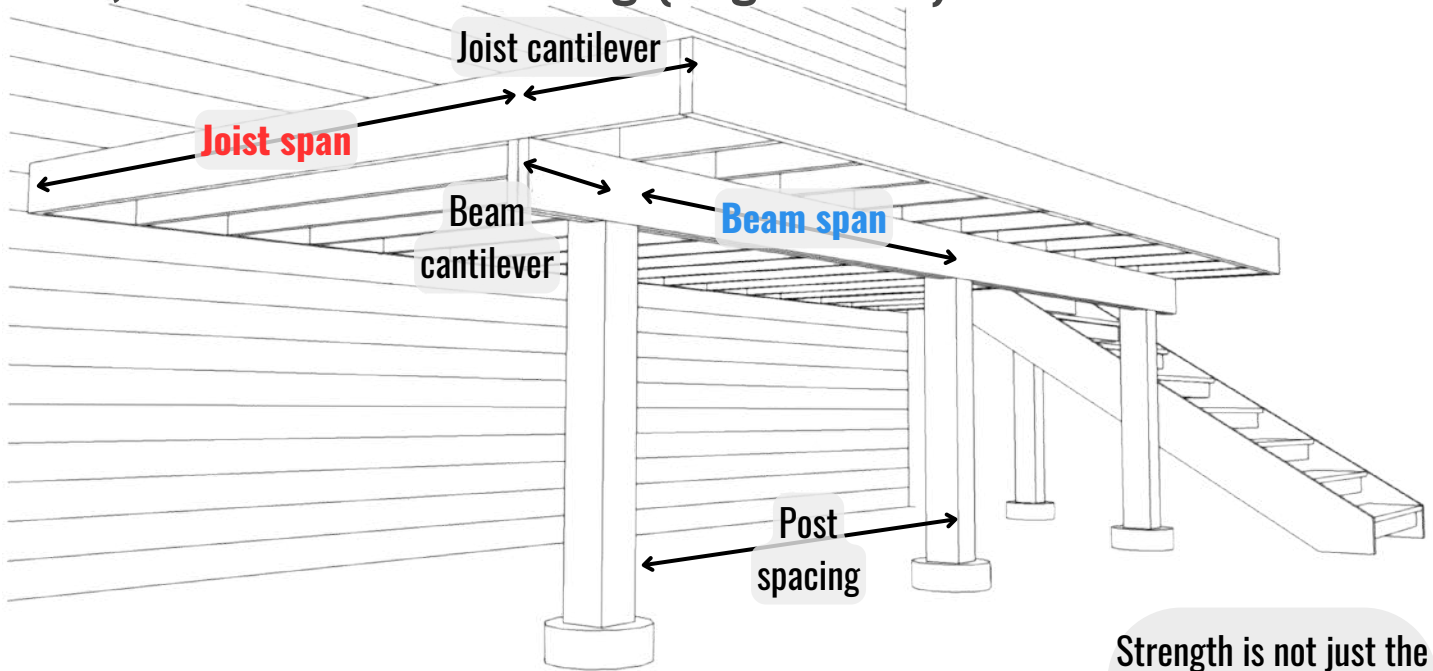

***Refer to local building codes to ensure compliance.**

Strength is not just the lumber size, but a combination of factors.

Stone typically needs **ONLY 5%** stronger framing than standard minimum requirements for wood decking.

We recommend a triple beam **EVERY** time as it reduces twisting and extends the life of your timber.

Maximum Joist Span Guide (Spruce, Pine, Fir)			
Lumber Size	16" Joist Spacing (408mm)	24" Joist Spacing (610mm)	Max. Cantilever
2" x 4" (51mm x 102mm)	5'7" (1702mm)	4'7" (1397mm)	6" (152mm)
2" x 6" (51mm x 152mm)	9'1" (2769mm)	8' (2438mm)	12" (306mm)
2" x 8" (51mm x 204mm)	11'7" (3531mm)	10'2" (3099mm)	16" (408mm)
2" x 10" (51 x 255mm)	13'7" (4140mm)	11'5" (3480mm)	24" (712mm)
2" x 12" (51mm x 306mm)	15'7" (4750mm)	13'3" (4039mm)	24" (712mm)

Designing a Plywood Deck Frame

Post, Beam and Joist Sizing (Page 2 of 2)

Maximum Post Spacing Guide (Spruce, Pine, Fir) - (Beam Span)

Beam Size	< 8' (2438mm) Joist span	< 10' (3048mm) Joist span	< 12' (3658mm) Joist span	< 14' (4267mm) Joist span	< 16' (4877mm) Joist span	Max. Cantilever
Double 2" x 6" (51mm x 152mm)	4'5" (1346mm)	3'11" (1193mm)	3'7" (1092mm)	3'3" (990mm)	2'10" (864mm)	12" (306mm)
Double 2" x 8" (51mm x 204mm)	5'8" (1727mm)	5'1" (1550mm)	4'7" (1397mm)	4'3" (1295mm)	3'10" (1168mm)	16" (408mm)
Double 2" x 10" (51mm x 255mm)	7' (2134mm)	6'3" (1905mm)	5'8" (1727mm)	5'3" (1600mm)	4'10" (1473mm)	16" (408mm)
Double 2" x 12" (51mm x 306mm)	8'2" (2489mm)	7'3" (2210mm)	6'7" (2007mm)	6'1" (1855mm)	5'8" (1727mm)	16" (408mm)
Triple 2" x 6" (51mm x 152mm)	6'5" (1956mm)	5'10" (1778mm)	5'3" (1600mm)	4'10" (1473mm)	4'6" (1371mm)	12" (306mm)
Triple 2" x 8" (51mm x 204mm)	10' (3048mm)	9'4" (2845mm)	8'7" (2616mm)	7'11" (2413mm)	7'5" (2261mm)	16" (408mm)
Triple 2" x 10" (51 x 255mm)	12'10" (3912mm)	11'6" (3505mm)	10'6" (3200mm)	9'8" (2946mm)	9'1" (2769mm)	24" (712mm)
Triple 2" x 12" (51mm x 306mm)	14'11" (4546mm)	13'4" (4064mm)	12'2" (3709mm)	11'3" (3429mm)	10'6" (3200mm)	24" (712mm)
Quad 2" x 6" (51mm x 152mm)	8'3" (2514mm)	7'4" (2236mm)	6'8" (2032mm)	6'2" (1880mm)	5'9" (1753mm)	12" (306mm)
Quad 2" x 8" (51mm x 204mm)	11' (3353mm)	10'3" (3124mm)	9'8" (2946mm)	9'2" (2794mm)	8'7" (2616mm)	16" (408mm)
Quad 2" x 10" (51 x 255mm)	14'11" (4546mm)	13'1" (3988mm)	12'1" (3684mm)	11'2" (3404mm)	10'6" (3200mm)	24" (712mm)
Quad 2" x 12" (51mm x 306mm)	17'2" (5233mm)	15'4" (4674mm)	14' (4267mm)	13' (3962mm)	12'2" (3709mm)	24" (712mm)

Choose step dimensions to reduce Tanzite cutting to a minimum. For easy installation with minimal wastage we recommend you design for:

- Tread depth equal to one Rainier stone flooring block. 1'(305mm)
- Tread (and riser) **width** equal to a full stone flooring block length 2'(610mm) or a multiple of that.
- Riser **height** typically 7 1/2"(191mm), which is achieved by ripping (cutting lengthways) a Rainier stone flooring block, or fascia board.

Mitre cut the aluminum to create the corner.
NO NEED TO CUT THE TANZITE.

Build strong for long-lasting steps.

The gasket-held Rainier system is groutless and flexible to some extent, but plywood steps and decks should not flex at all and they should provide a flat and even surface for the installation of stone flooring blocks.

PRO TIP: Glue and screw a diagonal '2x4' timber to one or both sides of the stair stringers to strengthen them.

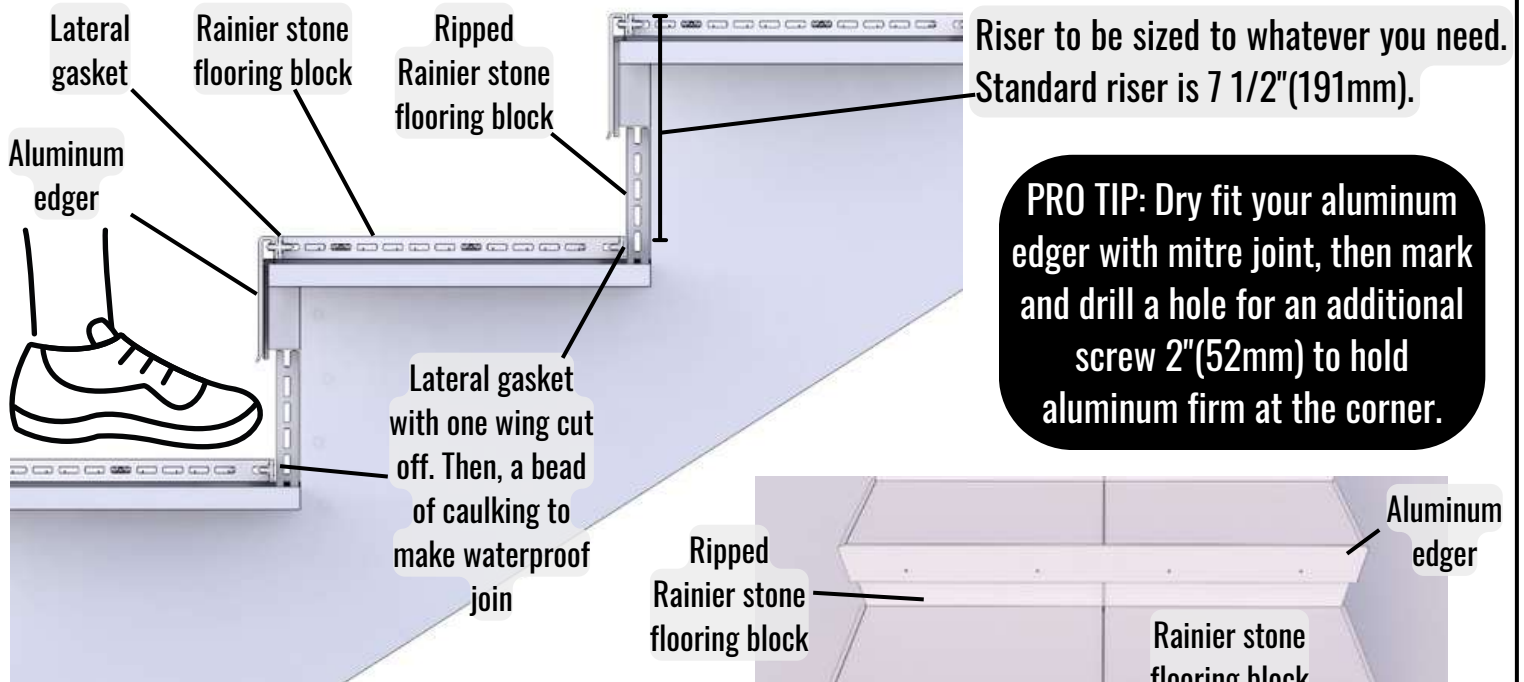

PRO TIP: Dry fit your aluminum edger with mitre joint, then mark and drill a hole for an additional screw 2"(52mm) to hold aluminum firm at the corner.

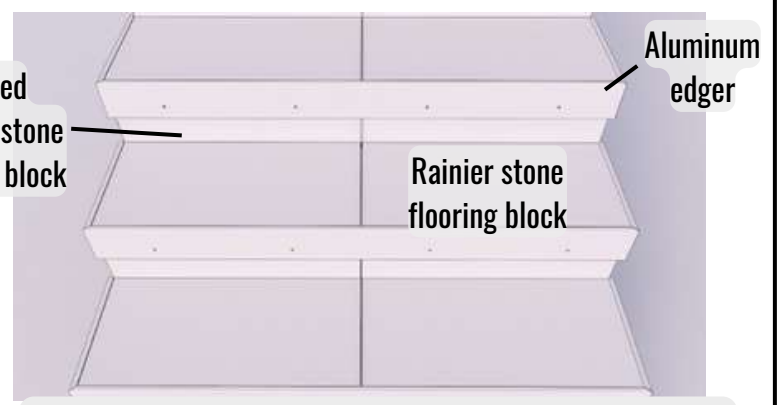

Looking at the stairs from above. Note, the aluminum edger has a mitre-joint to create a neat corner.



Building Plywood Steps (Page 2 of 2)

Installing a basic step structure and Tanzite:

1. Cut stair strings and place them next to each other to check/ adjust to ensure that they are as close to identical as possible.
2. Install the strings, using a long level to ensure they match at every point in all dimensions.
3. With strings in place, install bridging on every step to ensure strength with minimal risk of twisting or other movement in the timbers.
4. Install plywood to risers, and also to stair sides.
5. Install plywood to stair treads, overrunning by 1" over the front and both sides.
6. Install 1'x2' batten directly under plywood overhang.
7. Install EPDM, to cascade down the steps, pushing it right into the corners and fixing with glue, starting from the top of the stairs, moving downwards.
8. Install aluminum edgers (with mitered corners) with bespoke screws.
9. Install risers: made by ripping Rainier stone flooring blocks.
10. Install fascia clips and fascia boards to the sides of the 'staircase'.
11. Install stair treads, attaching lateral gaskets and using gentle pressure to push them snugly into place.

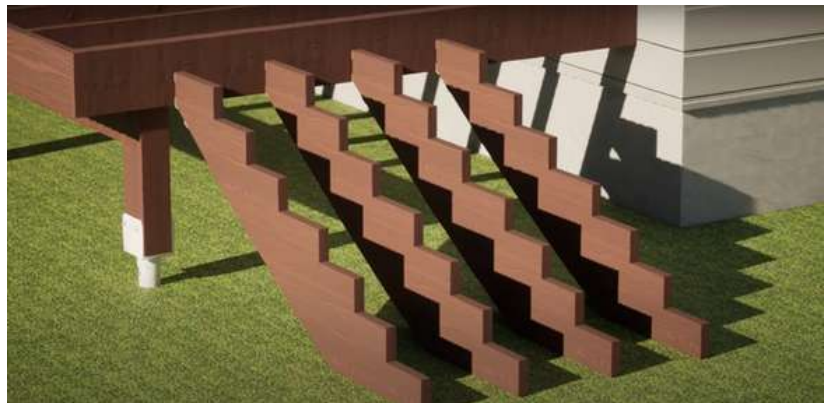

PRO TIP: If using joists or stringers that are not perfectly straight, line them up together and plane them to create a perfect set.

NOTE: Planing individual joists or stringers is not recommended.



Installing fascia mounted railing will avoid the need to drill through Rainier stone flooring blocks. But if you use surface mounted railings:

1. Determine the location of each railing post and mark on the stone flooring block where you require holes for the railing post fixings.
2. Ensure stone flooring block is fully supported on a scrap piece of plywood, and pre-drill each hole using a diamond hole saw, or tile drill bit that is at least 1/12"(2mm) larger than the screws that you will use to fix the railing. The screws should not be in contact with the stone flooring block, thereby reducing the risk of breakage. See Extra Recommendations sections in this manual.
3. Tighten the screws slowly. If needed, place a shim between the post base and the stone flooring block to make the post plumb.
4. Complete the railing as per manufacturer's specifications.

Always check local building codes for railings.

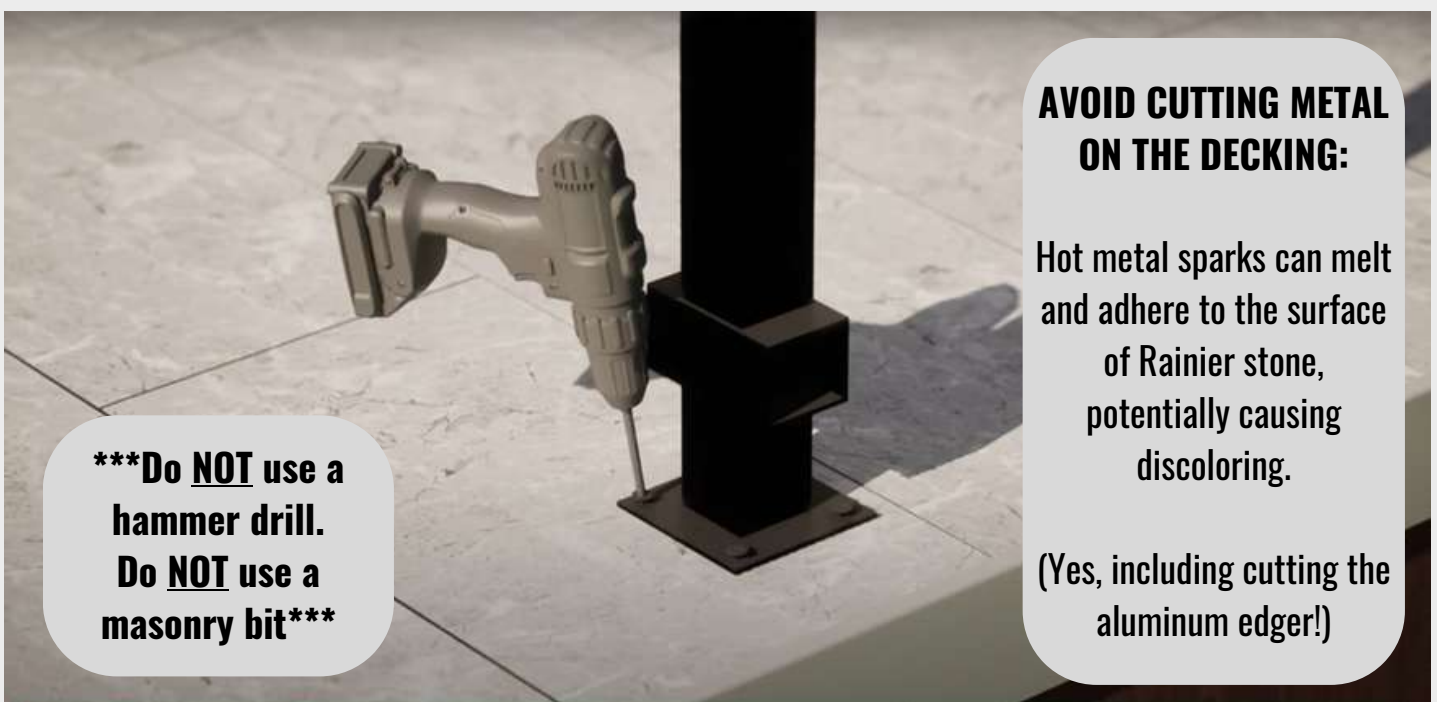

AVOID CUTTING METAL ON THE DECKING:

Hot metal sparks can melt and adhere to the surface of Rainier stone, potentially causing discoloring.

(Yes, including cutting the aluminum edger!)

*****Do NOT use a hammer drill. Do NOT use a masonry bit*****

How to Install Tanzite Rainier Covering an Existing Wood Deck

Tanzite
STONEDECKS

The Rainier system is perfect to cover an existing wood deck. It waterproofs the old deck, which in most cases extends the life of the original structure.

First, make sure that you have at least 1" of space between the bottom of any door, and the top of the current decking. The Rainier stone will fit in this space.

Next, make sure the structure is solid and there are no rotten boards. Replace rotting deck boards and/or framing boards as necessary.

Check to see if the deck has at least a 1% slope to avoid pooling and to ensure the water runs off in the correct direction.

If the existing deck has no slope, cut the posts down slightly. Do this by using a jack to temporarily support/lift the beam, then use a sawsall to cut a little off the posts, then set the beam back down on the posts and remove the jack.



How to Install Tanzite Rainier

Covering an Existing Wood Deck (2 of 2)

Tanzite
STONEDECKS

If you have surface-mounted railing posts already installed, mark each post and rail connection then remove them and set aside to be reinstalled once the stone flooring blocks are in place.

To ensure the surface is flat and even, run a floor sander over the surface to even it out. A large planner could also be used.

Now you're ready to install the membrane and the Rainier stone.

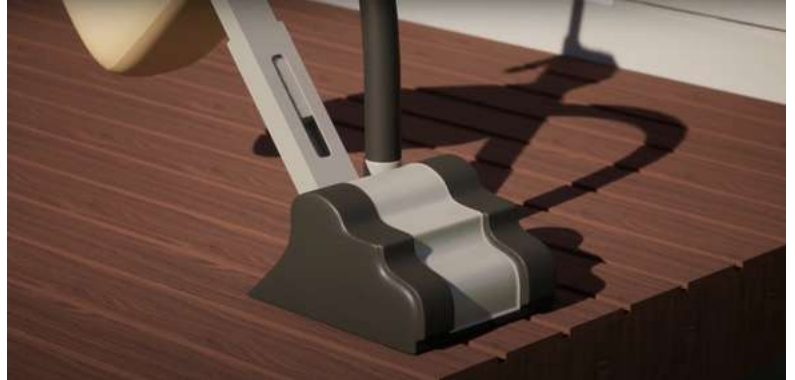

EPDM = WATERPROOF

The EPDM is purely to make it waterproof so as to protect the timber below.

EPDM is OPTIONAL/ NOT needed if the structure is already waterproof, if you don't have timber to protect, and if there is no other reason to make it waterproof.

How to Install Tanzite Rainier Covering a Vinyl Deck

Tanzite
STONEDECKS

Covering vinyl decks is relatively easy since they are already made from plywood and have a bit of slope.

Ensure the structure is solid and there is no rotten wood.

If you have surface-mounted railing posts already installed, mark each post and rail connection then remove them and set aside to be reinstalled once the Rainier stone is in place.

If the existing vinyl is still waterproof, you can install the Rainier stone directly over the vinyl, without an additional EPDM membrane.

As an extra layer of protection, you can choose to add an EPDM membrane on top of the existing vinyl.

Otherwise, remove the existing vinyl and install the new EPDM membrane.



How to Install Tanzite Rainier

Installing the EPDM Membrane

Tanzite
STONEDECKS

EPDM = WATERPROOF

The EPDM is purely to make it waterproof so as to protect the timber below. EPDM is **OPTIONAL/ NOT** needed if the structure is already waterproof, if you don't have timber to protect, or there is no other reason to make it waterproof.

Lay the waterproof EPDM membrane flat, allowing excess to overhang all exposed deck sides, and folded back from the house. At the house wall there are three options:

1. Remove the siding.

Remove the siding so that the membrane can extend up the wall behind it.

This method ensures that the joint at the house is waterproof and doesn't have a seam.

To go around a door jam, carefully cut EPDM around the door jam, and then caulk to seal the gap between EPDM and the door jam.

2. Seal to house membrane.

If there is existing flashing on the house, you can seal the membrane to it using EPDM sealant.

3. (next page) Separate from house

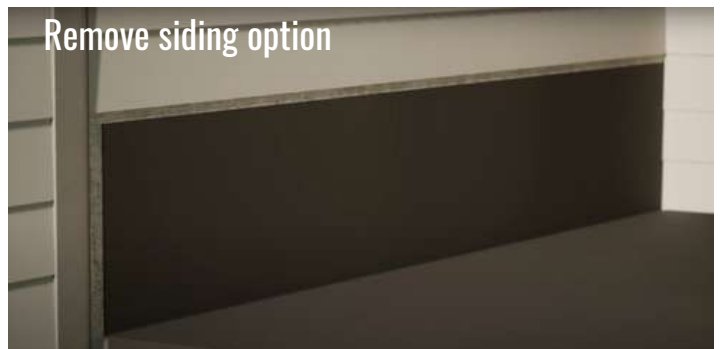

Remove siding option

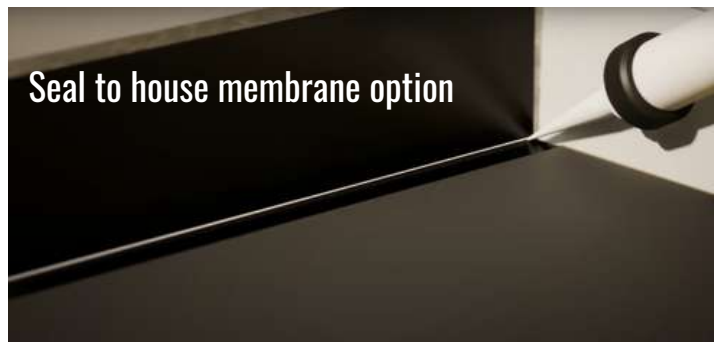

Seal to house membrane option

How to Install Tanzite Rainier

Installing the EPDM Membrane (2 of 2)

3. Separate from house

The deck can be separated from the house, either by using another beam instead of a ledger board, or a bracket that sets the ledger board off the house.

In this case, just leave a slight gap, about half an inch, between the edge of the deck framing and the house wall.

Then the membrane can go over the deck structure, leaving an air gap between.

Then, if desired, use caulking to fill the top edge of that joint to have nearly all the water drain over the top of the deck.

Leave all the excess membrane hanging further than needed off the other side of the deck and cut off the excess at the end.

Seperate from house option

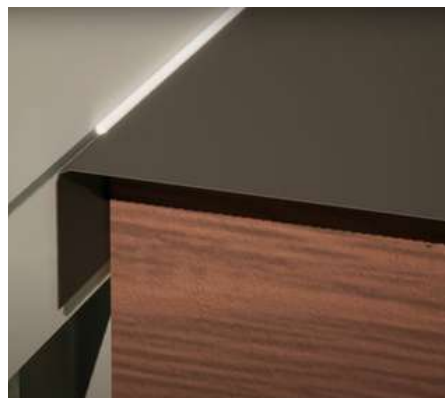

How to Install Tanzite Rainier

Installing Stone Flooring Blocks (Page 1 of 3)

Install the edger around any exposed edges, or if using a different edge restraint for ground installation check that the finished height will match the height of the stone surface.

The edge restraint can be cut to go between railing, if needed.

Stone flooring blocks can be laid in a variety of patterns, and any pattern can be 'picture-framed' with a border, which is created using a single row of stone flooring blocks all the way around the deck. This is possible because the protrusions of the end gasket, will fit into neighboring flooring blocks in either direction.

Once you've placed your 'picture frame', or if you choose not to use one, you can now begin on your first row, by pushing an end gasket into both sides of the first stone flooring block and placing it in your starting corner.

Then add the next stone with end gasket attached, and so on as you work your way along the row.



PRO TIP: The stone flooring blocks vary very slightly in colour and dimension, so lay them out BEFORE making cuts - This way you optimise the overall appearance.

Common patterns

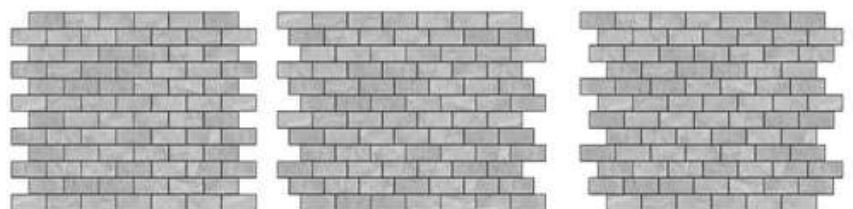
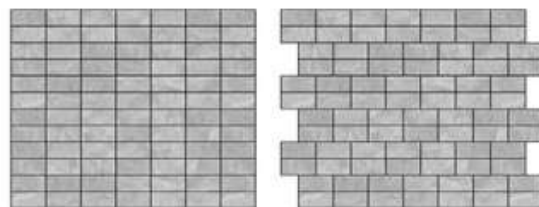

How to Install Tanzite Rainier

Installing Stone Flooring Blocks (Page 2 of 3)

Tanzite
STONEDECKS

Cut the stone flooring blocks to length as needed.

Once you have a row laid out, adjust the lateral gasket if necessary.

Start the next row using a well planned 'offcut' piece, of the required length to achieve your desired pattern.

For this reason, make each cut with care, so that the offcut can be used for the start of another row.

For example, to achieve a running brick bond pattern you would start with a full piece on the 1st row, then a piece cut in half to start the 2nd row, a full piece for the 3rd, and the cut off from the 2nd row will be used to start the 4th row.

Rip cut the final row of stone flooring blocks to fit along the side of the house. To cut Rainier stone use a diamond blade, made for glass or porcelain, and cut with the finish side facing the blade. After making the cut, use the hand polishing pad to slightly bevel the edge for a clean finish.



How to Install Tanzite Rainier

Installing Stone Flooring Blocks (Page 3 of 3)

Tanzite
STONEDECKS

Cut/Rip the final row of stone flooring blocks to leave a gap that is at least 1/4"(6mm) from the wall, then caulk this gap with an exterior grade caulking.

If possible, install the siding J-trim just over the top of the Rainier stone.

Install surface mount railing by marking the holes for the railing posts onto the stone.

Once marked, remove the railing then drill holes through the Rainier stone, making the holes at least 2mm larger than the lag bolts so that the bolt does not make contact with the stone.

Add caulking to the pre-drilled holes then reinstall the post, fastening the lag bolts through the stone and into the wood structure below.

For added protection, caulking can be added to the post base as well.



Leave at least 1/4"
(6mm) expansion gap
at the house wall. Fill
with exterior
caulking.



How to Install Tanzite Rainier Rooftop Installation (Page 1 of 4)

Tanzite
STONEDECKS

The Rainier decking system can install directly on a flat roof without any pedestals or additional work.

The biggest advantage is that the majority of the water, and all of the debris, stays on top of the stone where you can easily clean it off. No more little trees growing out from under your roof deck, or forks getting lost underneath!

First, lay your EPDM membrane, then a woven fabric protection layer over the EPDM membrane. A simple woven landscape fabric works well.

Install the edge restraint around any exposed perimeters, checking that the finished height is even to the height of the stone. If possible, leave one side without the edge restraint for now.

The edge restraint can be cut to go between railing posts, if needed.

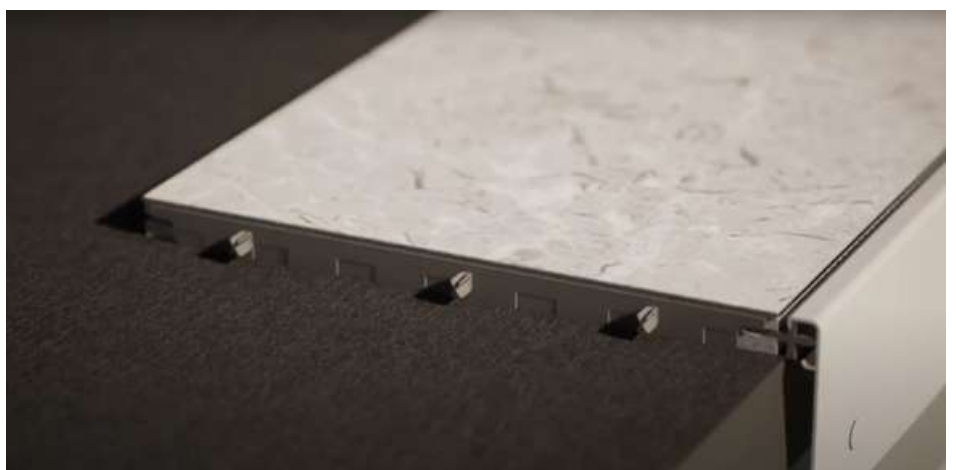

How to Install Tanzite Rainier Rooftop Installation (Page 2 of 4)

Tanzite
STONEDECKS

Next, slide an end gasket into both sides of the first stone flooring block.



Add the next stone flooring block in the row along with the end gasket.



Cut the Rainier stone flooring blocks to length as needed.



Once you have the first row laid out, adjust the lateral gasket if needed, and slide that row into the edge restraint.



If you are setting the stone against a wall, simply trim the end gasket by cut off the protruding edge.



How to Install Tanzite Rainier Rooftop Installation (Page 3 of 4)

Tanzite
STONEDECKS

Simply cut the stone flooring blocks to create your desired pattern. Commonly offsets/patterns of $\frac{1}{2}$ or $\frac{1}{3}$ are used to add interest while easily making useable cutoffs to start or finish another row.

Use the offcut from the 1st row, to start the 2nd row, then proceed along the row with whole stone flooring blocks, and using the offcuts as you go.

Rip cut the final row of stone to leave a $\frac{1}{4}$ "(6mm) gap to the wall, to be caulked with an exterior grade caulking.

Now, install the final piece of edge restraint on the exposed side of the deck.

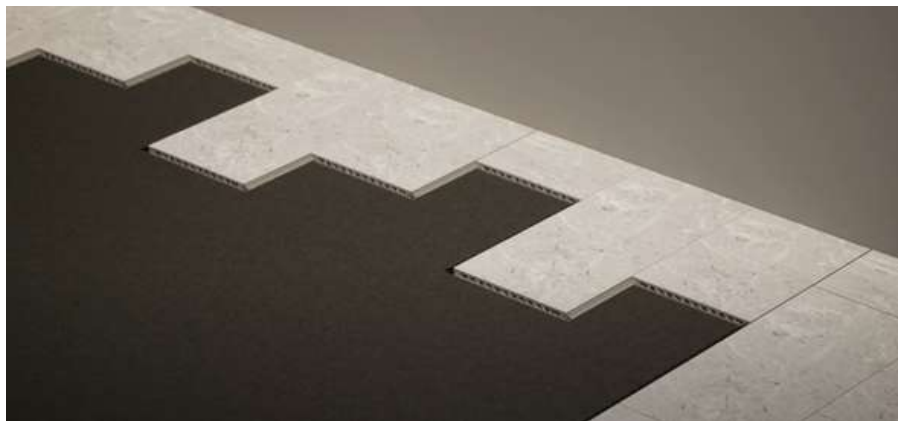

How to Install Tanzite Rainier Rooftop Installation (Page 4 of 4)

Tanzite
STONEDECKS

As Rainier stone lays directly on the membrane you can also lay it alongside artificial turf that lays on the same membrane, glued to the woven protection fabric.

You could also lay Rainier stone next to rocks, creating a rock garden on your roof.

Tanzite's Rainier Collection creates an easy-to-install patio for your rooftop that also gives you amazing design alternatives to create a truly unique space on your rooftop.

Best of all, it'll be low maintenance and easy to keep clean. Every time you rinse it off, you'll be actually removing the debris rather than trapping it below the deck.



EPDM = WATERPROOF

The EPDM is purely to make it waterproof so as to protect the timber below- ie. EPDM is **OPTIONAL/ NOT** needed if the structure is already waterproof, if you don't have timber to protect, or there is no other reason to make it waterproof.



How to Install Tanzite Rainier Concrete Resurfacing (page 1 of 3)

Tanzite
STONEDECKS

You can easily resurface damaged and cracked concrete creating a beautiful new surface, as long as the concrete is solid.

Rainier works well even when the surface is pitted as it doesn't rely on adhesion to the concrete.

First, patch any holes or dips in the concrete. The patch doesn't need to stay adhered since the stone tiles doesn't adhere to it. The patch is just making a perfect shim to even out the surface.

Ensure the patio has a one percent slope away from the house.

Install the edge restraint around any exposed perimeters, checking that the finished height of the edge restraint will match the height of the stone surface. If possible, leave one side without the edge restraint for now.

If the concrete is on the ground, you can simply use any other edge restraint that fastens to the ground.

The edge restraint can be cut to go between railing posts, if needed.



How to Install Tanzite Rainier Concrete Resurfacing (page 2 of 3)

Tanzite
STONEDECKS

Next, slide an end gasket into both sides of the first stone flooring block.



Add the next stone in the row, adding the end gaskets as you go.



Cut the stone flooring blocks to length as needed, to fit the row length.

Once you have the first row laid out, slide the lateral gasket into the groove of the stone flooring blocks, and slide that row into the edge restraint.



If you are setting the stone against a wall or other end restraint, simply cut off the protruding edge from the end gasket.

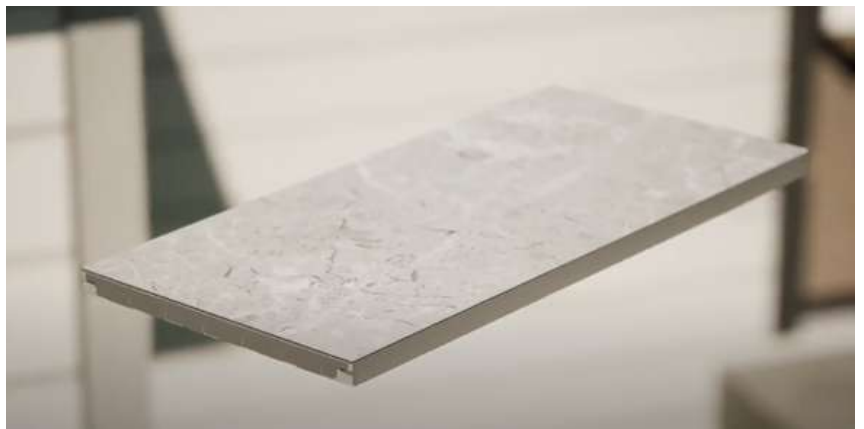

How to install Tanzite Rainier Concrete resurfacing (page 3 of 3)

Tanzite
STONEDECKS

Start the next row using a piece cut into one third (the next row will start with the leftover of that piece, being two thirds.)



Then proceed along the row with full stone flooring blocks.



Alternatively, you can start with a stone flooring block cut in half, so that you have a one-half offset pattern.

Rip cut the final stone flooring block to fit into the side of the wall leaving a 1/4" (6mm) gap to the wall.



Then, caulk the gap between the final row of stone and the wall.



Now install the final piece of edge restraint on the exposed edge of the deck.



How to Install Tanzite Rainier Paving Resurfacing

Tanzite
STONEDECKS

You can easily resurface damaged and uneven paving stone creating a beautiful new surface, as long as the patio is solid.

First, screed over the patio using a finely crushed rock, or sand, to create a flat surface.

Make sure the patio has at least one percent slope.

Then lay the foam underlayment over top of the sand/fine rock.

Raise the existing edge restraint around the paving stone, to the new elevation of the Rainier stone surface. Alternatively, you can install any other edge restraint.

Follow as per instructions for resurfacing concrete (Page 40)



How to Install Tanzite Rainier Ground Installation (1 of 3)

Tanzite
STONEDECKS

The Rainier system easily installs directly onto the ground, just like a paving stone. This allows you to have the same product on your deck, stairs, patio, and walkway, using the same stone and completing the uniform look for your outdoor space, reducing wastage in the process.

First, remove any black dirt, and other soil, to excavate for a solid base.

Compact the existing ground.

Then, install a compacted granule base for the foundation.

Now screed over the granule base using a finely crushed rock, or sand, to create a flat surface.

Make sure the patio has at least one percent slope.

Then lay the foam underlayment over top of the sand, or fine rock.

Install an edge restraint around the paving stone, to the desired height of the Rainier stone surface. This can be a wood, plastic, or metal barrier.



How to Install Tanzite Rainier Ground Installation (2 of 3)

Tanzite
STONEDECKS

Next, slide an end gasket into both sides of the first stone flooring block.

Add the next stone in the row, adding the end gaskets as you go.

Cut the stone flooring blocks to length as needed, to fit the row length.

Once you have the first row laid out, slide the lateral gasket into the groove of the stone flooring blocks, and slide that row into the edge restraint.

If you are setting the stone against a wall or other end restraint, simply cut off the protruding edge from the end gasket.

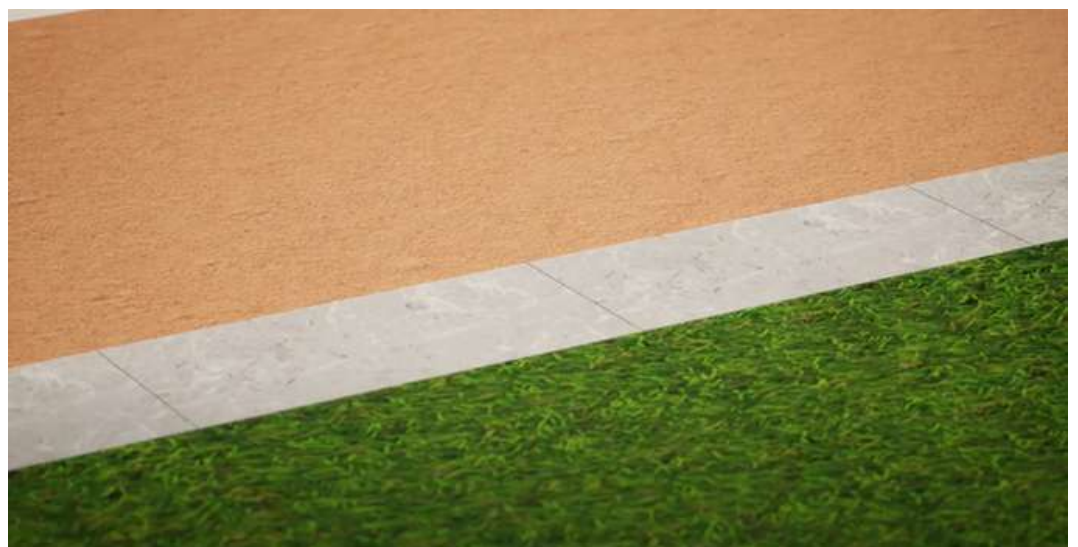

How to Install Tanzite Rainier Ground Installation (Page 3 of 3)

Tanzite
STONEDECKS

Start the next row using a piece cut into one third (the next row will start with the leftover of that piece, being two thirds.)



Then proceed along the row with full stone flooring blocks.



Alternatively, you can start with a stone flooring block cut in half, so that you have a one-half offset pattern.



Rip cut the final row of stone to leave a 1/4" (6mm) gap to the wall.

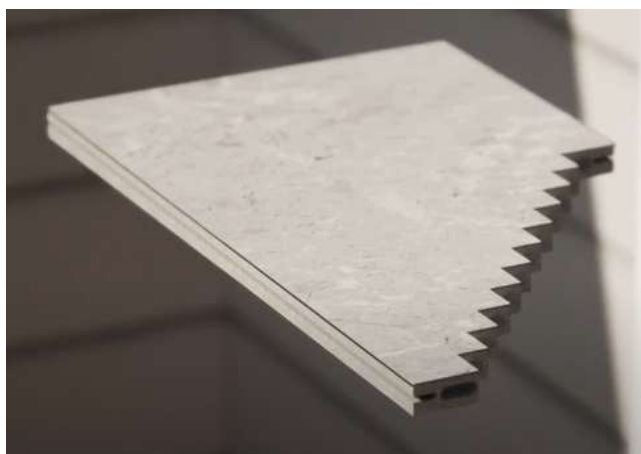

Then, caulk the gap between the final row of stone and the wall.



General Advice for Installing, Maintaining and Repairing Tanzite

Tanzite
STONEDECKS

Cleaning rust stains

Rust stains can be cleaned using a non-acid rust remover. We suggest using Evapo-Rust cleaner.

<https://www.evapo-rust.com/evapo-rust-remover/>

Sanding Tanzite

Edges and corners, especially after making a cut, should be sanded smooth using a diamond sanding pad. We supply diamond sanding pads on our website.

Drilling Tanzite

Tanzite can be drilled with a regular drill (do not use a hammer drill or masonry bit) and a diamond hole saw. Holes must be drilled to be at least 1/12"(2mm) larger than the screw, so that the screw will not touch the Tanzite. The Tanzite acts as a spacer. Ensure Tanzite is flat and fully supported on timber blocking whilst drilling, and when installed to prevent Tanzite breakage. Tanzite has abundant compressive strength, but should not be subjected to torsion (eg installed or drilled on uneven base).

Drill bit life can be extended by using water. 'Glass and tile' drill bits work well. We suggest Bosch Glass & Tile. <https://www.boschtools.com/us/en/boschtools-ocs/glass-and-tile-bits-39422-c/>

If you are drilling more than a few holes we suggest using a drill press to drill faster and extend the life of drill bits because the drill press allows you to put sufficient pressure and water on the bit without fatiguing. We suggest using a small portable drill press like the 10" Ryobi.

<https://www.ryobitools.com/products/details/33287163342>

Cutting Tanzite Stone **If dry cutting wear an approved dust mask or respirator******

Tanzite can be cut with a regular saw using a diamond blade. Using a continuous thin-rim diamond blade will make a cleaner cut. We suggest using a glass/ tile/ porcelain blade. A hand-held grinder (angle grinder) with a diamond blade works well for detailed cuts, such as fitting a piece around a gas pipe. If you're making a lot of cuts, we suggest using a wet tile saw. After making each cut, round the edge using a diamond sanding pad.

**CUT AND DRILL OUTSIDE OR
IN A WELL VENTILATED AREA**

Caution when cutting Tanzite as it may produce silica dust

Airborne dust during cutting can be reduced with water and adequate ventilation, but you should always consider appropriate personal protective equipment including respiratory, eye, sound and vibration protection.

General Advice for Installing, Maintaining and Repairing Tanzite

Tanzite
STONEDECKS

Color enhancement sealer

Sealing Tanzite can make the color brighter and more vibrant, similar to how it looks when wet. We suggest Enrich'N'Seal™ from Aqua-Mix.

<https://aquamix.com.au/products/sealers/enhancing-sealers/enrichnseal/>

Regular cleaning

Simply wash down the Tanzite as needed, preferably with eco-friendly cleaning products. A pressure washer can be used also. For regular cleaning, we suggest Spray & Forget Outdoor Cleaner.

<https://www.sprayandforget.com/product/sfhdspry/>

Cleaning grease stains

Wash the grease stain using a concentrated solution of detergent; we suggest Dawn Platinum. If the stain persists, use an engine oil degreaser. We suggest Purple Power Industrial Strength Cleaner/Degreaser.

<https://www.clean-rite.com/industrial>

Cleaning paint splatter

Use a paint splatter remover to clean off the paint. If the paint has dried, use a graffiti remover. We suggest Goof Off Graffiti Remover.

<https://gooffproducts.com/graffiti-remover-non-nmp/>

Chip repair

If you get a small chip in the stone, it can be colored to visually hide the chip. We suggest using a Sakura Pen-Touch paint marker.

<https://www.sakuraofamerica.com/product/pen-touch/>

Scratches to aluminum

Small scratches to the powder coated aluminum edger can be colored using a Sakura Pen-Touch paint marker to reduce the visual impact of the scratch.

<https://www.sakuraofamerica.com/product/pen-touch/>

General Advice for Installing, Maintaining and Repairing Tanzite

Tanzite
STONEDECKS

General maintenance

Clean Tanzite with soap and water and/or a pressure washer. You can also use an eco-friendly ice melter for ice, a degreaser for grease stains, and any other cleaning products that specify that they are suitable for natural stone. Avoid using harsh chemicals or acids.

Once a year, or as needed, check that the decking structure and railings have not moved or deteriorated. Also, check that the Tanzite has not become damaged. Replace any damaged or deteriorated components of the deck.



Problem	Solution
<p>A Tanzite stone flooring block cracked when:</p> <ul style="list-style-type: none"> • I stepped on it. • I installed railing posts. 	<p>One way or another, the stone flooring block has been subjected to strain that is not designed for, most likely because it is not fully supported.</p> <p>The stone must be installed onto an even and fully supported plywood and timber structure with no protruding timber, screws, nails, or any other cause of unevenness. When building your decking frame, ensure each joist makes contact with the plywood, at each intersection. Use shims if needed to achieve this. Install blocking(bridging) every 8ft(2.4m) along the length of the joists, and under each railing post as, without adequate blocking, the joists can twist.</p> <p>Establish the cause of the problem:</p> <ul style="list-style-type: none"> • If accessible, look underneath the deck to see the underside of the plywood. Ensure plywood makes contact with all joists that it passes over. • Ensure there is nothing protruding upwards from the plywood - screw, nail, timber, site rubbish of any kind (it happens). • Ensure adequate beam size, beam span, joist size and joist span were used so that the structure is sufficiently robust and not strained. • Loosen railing post, ensure bridging is installed, and that drill hole through Tanzite allows for bolt to pass through without making contact with the stone. <p>Finally, apply whatever you found to the rest of the deck, reducing the risk of any other breakage.</p>

Problem	Solution
Concrete, Cement, stucco	<p>Avoid getting concrete, cement or stucco dust on the Tanzite deck by covering it with board and sheets when working nearby with concrete, cement or stucco. However, accidents happen, and you can use a concrete disolver and scraper to remove concrete, cement and stucco from the surface of Tanzite. Avoid any harsh chemical or acidic products.</p>
Paint splatter	<p>The same applies to paint- it's just easier to cover it properly, than clean off mess and risk damage afterwards. Use a paint splatter remover to clean off the paint. If the paint has dried, use a graffiti remover. We suggest Goof Off Graffiti Remover. https://gooffproducts.com/graffiti-remover-non-nmp/</p>
Debris, dirt, mud Ice and snow Grease	<p>Clean Tanzite using a firm brush, with soap and water or a pressure washer. You can also use an eco-friendly ice melter for ice, a degreaser for grease stains, and any other cleaning products that specify that they are suitable for natural stone. Avoid using harsh chemicals or acids.</p>
Hard water staining	<p>Hard water has a high concentration of minerals such as lime, silica and calcium, due to the geology from which it is sourced. When it dries out, minerals may be left behind as a visible deposit on the decking, which can be removed using white vinegar, and then thoroughly rinsing using a hose or power washer. If needed, use a hard water stain remover.</p>
Rust stains	<p>Rust stains can be cleaned using a non-acid rust remover. We suggest using Evapo-Rust cleaner. https://www.evapo-rust.com/evapo-rust-remover/</p>
Chipped edges	<p>Score Tanzite before cutting it. Use a fine and thin, continuous-rim diamond blade on a wet saw to reduce chipping to a minimum. Sand the edge to smooth it. Most chips can be removed by sanding a bevel into the cut edge. If needed, use a paint touch-up pen to reduce visual impact. Where possible, install any chipped edges in places where they are less visible.</p>

At Tanzite, we are committed to preserving and protecting our beautiful world for future generations. We believe that by working together, we can make a significant impact on the environment. As part of this commitment, we continuously monitor opportunities to improve our manufacturing processes, logistics operations, and administrative procedures.

As investors in both people and the planet, we prioritize sustainable practices throughout our entire business. Our goal is not only to create exceptional products but also to minimize our ecological footprint. Tanzite is proud to offer a range of products that are naturally durable and reusable. By utilizing sustainable materials and implementing efficient production methods, we ensure that every Tanzite product is designed with longevity in mind. This approach not only reduces waste but also encourages the reuse of materials wherever possible.

We firmly believe that it is our responsibility to contribute positively to the world around us. Through ongoing innovation and a steadfast commitment to sustainability, Tanzite strives to set an example for other companies within our industry.

PRODUCT

- Non-destructive installation easy to reuse.
- Does not contain plastic or PFAs or other chemicals.
- Made using sustainable materials.
- Durable long life.
- High-quality low replacement.
- Easy to replace breakages.
- No chemicals required for maintenance.
- Designed to reduce construction waste.

LOGISTICS

- Our factory is close to the raw materials to reduce transport-associated emissions.
- We reduce packaging to a minimum.
- Our packaging is made of recycled material.
- Our logistics providers are selected using sustainability criteria.
- We promote low-carbon shipping options.

MANUFACTURING

- Material suppliers selected using sustainability criteria.
- Manufacturing process optimized to reduce energy and material use.
- Site operational policy for energy saving and carbon reduction in buildings.
- Tanzite does NOT contribute to deforestation.

SUSTAINABLE BUSINESS

- An industry leader with a sustainability mindset.
- Sustainability in all aspects of our business.
- Investors in people and planet.
- Responsible purchasing.

On-site/ Handover Checklist

Checklist (page 1 of 2).

The purpose of this checklist is to support easy installation, reducing mishaps and increasing satisfaction for installer and customer. Its use is recommended, but it does not affect the warranty and it is not submitted to Tanzite.

- We recommend that the installer and homeowner fill in this document together, or that you use it as a site inspection tool.

Signature on completion with date (Installer):

Signature on completion with date (Homeowner):

NOTE: THIS CHECKLIST IS <u>NOT</u> EXHAUSTIVE It includes two sections: 1. Deck frame checks- BEFORE installing Tanzite. 2. Tanzite decking final checks.	Relevant page in manual	Check off during installation	Final check before handover
1. Deck frame checks- BEFORE installing Tanzite:			
Bridging is installed between joists at least every 8ft (2.4m), to reduce joists twisting and to make the deck frame stronger.	21		
Extra bridging is installed between joists, wherever a railing post will be fixed and in the neighbouring joist space also, and where stairs connect to the deck.	21		
The tops of the joists are level to each other so plywood sits flat.	21		
All timbers are of sufficient size for the spans.	23		
The wood does not appear rotten or weak.			
Every plywood board starts and ends on a joist, and is supported and fixed mechanically to every joist it passes over.	22		
Deck slopes away from the house by 1 or 2 degrees.	19		

On-site/ Handover Checklist

Checklist continued (page 2 of 2).

NOTE: THIS CHECKLIST IS NOT EXHAUSTIVE	Page in manual	Check off during installation	Final check before handover
2. Tanzite decking checks:			
EPDM is free of holes or other damage, and provides a complete waterproof layer from the house wall to the vertical sides of the deck.	31		
Steps feel solid and don't feel at all springy.			
Railing posts feel solid and don't flex when leaned against.			
Any warpage in the boards has been evened out to minimize visual impact.			
Any chipped edges or other visually compromised stone flooring blocks have been installed in inconspicuous places where they will have less visual impact.			
Any spare stone, decent-sized offcuts, clips or other parts have been stored together on-site, and the owner is aware of their whereabouts, in case they need to use them in future.			

EXCLUSIONS FROM WARRANTY COVERAGE AND LIMITING OF LIABILITY:

Product installation:

The Product must be installed in accordance with industry standards and the Manufacturer's written specifications for installations including but not limited to industry standards, such as, but not limited to waterproofing, crack isolation, substrate requirements, movement, and expansion joints. This also includes requirements such as checking before installation that the Product has no defects, the Product is fit for purpose, checking for sufficient quantities of the Product of the same batch are supplied, the proper blending of the variation of colors of the Product supplied, and compliance with the Manufacturer's written specifications and industry standards for installation, maintenance, and repair. If a defect is identified in the Product before installation, the Product shall not be installed, as installation of the Product with a defect identifiable before installation or visual defects or nonconformities apparent prior to installation voids this warranty. Once the Product has been installed, the Manufacturer is not liable for color matching or blending or for the replacement of tiles with obvious visual faults. Water, ice, oil, grease, and other substances create slippery conditions, and the Manufacturer is not responsible for and makes no express or implied warranty respecting the suitability or fitness for any purposes including but not limited to floor applications in or with slippery conditions. Damage during or after installation and installation defects are not covered by this warranty, and this warranty does not apply when deterioration results from the Product not being suitable for the intended use, a design or installation not complying with applicable codes, standards and recognized work procedures, or if the installation the Manufacturer's written specifications have not been followed. Damage or cracking due to structural movement, collapse or settling of the ground or supporting structure, excessive deflection or other failure in the substrate, normal wear and tear, damage or defects caused by incorrect installation, lack of proper maintenance, accidents, abuse or misuse are excluded from coverage under this warranty. Defective installation such as, but not limited to, any substrate repair material or any accessory products such as third part fasteners; weak concrete and masonry substrates, substrate or sub-floor irregularities; substrate or subfloor deterioration; natural color variations; freight, material and labor costs.

Lippage:

Lippage refers to differences in elevation between edges of adjacent boards. The perception of height variances is influenced by a number of factors, including allowable warpage of tiles, warpage of the deck structure, the angle of light creating shadows and highly reflective surfaces accentuating otherwise acceptable variance in modules. After installation when lippage is present it should be corrected by the installer. To eliminate or address lippage, the proper preparation of the base and installation of the Product is required by skilled professionals. Lippage is an installation defect and not covered by this warranty.

EXCLUSIONS FROM WARRANTY COVERAGE AND LIMITING OF LIABILITY:

Variations:

Variation in veining, fissures, pits, texture, color and shade are inherent characteristics of all stone, and will vary from piece to piece as well as from lot to lot. The Manufacturer does not warrant the Product for shade, size, thickness, warping, cleft variations, surface finish variations, or other natural variances on the Product. An inherent characteristic of the Product, is that tiles will bow, wedge and warp to a certain degree and may slightly vary in size from batch to batch. These variations in size and color are due to changes in moisture and thermal loads which can alter the boards during production. Batches of board are identified and separated into lots by specific shade and caliber. Product samples are representative only and may not be an exact match to supplied materials due to variations in manufacturing and the natural raw materials making the Product. Photographic color images may not be an exact product match to the supplied Product as the supplied Product may have slight differences in color, shade, and/or surface appearance. The Manufacturer's website, marketing literature and promotional materials may not represent the true nature of the Product.

Maintenance and cleaning:

The Product must be properly maintained and cleaned in accordance with the Manufacturer's Tanzite Owner's Manual, and Manufacturer's written specifications and industry standards. Failure to regularly and properly clean and maintain the Product will void this warranty. The Product contains abrasives creating a rough surface, and cleaning challenges because dirt and other contaminants lodge in the surface. Extra attention is necessary to assure contaminants are removed promptly. For clarity the Product should not be in contact with any toxic substances, acids, bases, or other substances that will damage its surfaces.

Normal wear and tear:

This warranty does not cover normal wear and tear and any other problems that are caused by conditions, malfunctions, or damage not resulting from defects at the time of purchase, in the manufacturing of the Products, in accordance with ANSI A137-1-2017 standards.

Impacts and abrasions:

The warranty does not apply to normal wear and tear, spalling or other breakage or damage that may be caused by impact, abrasion or inappropriate or inadequate live loads. Never allow hard, sharp-edged, or heavy, objects to fall or otherwise causing an inappropriate load on the Product as any resulting such damage, chipping, or cracking, to the surface of the Product is not covered by this warranty.

EXCLUSIONS FROM WARRANTY COVERAGE AND LIMITING OF LIABILITY:

Misuse of the Product:

The misuse including but not limited to accidents, negligence, physical or chemical abuse or other damage to the Products that may result from deliberate act or negligence on the part of the customer, buyer, owner of the property where the Product is installed, installer or any third party is not covered by this warranty. The improper handling, storage, abuse or neglect of Product on the part of the customer, buyer, owner of the property where the Product is installed, installer or any third party is not covered by this warranty.

Acts of God, Ordinary Wear and Tear, Intentional or Negligent Acts:

This warranty does not apply to any damage resulting from or related to an act of God [including but not limited to flooding, tornado, strong winds, storms, fire, lightning, earthquake etc.]; environmental conditions and atmospheric conditions [air borne pollutants and contaminants]; staining from foreign substances [acids, bases]; normal weathering including but not limited to exposure to sunlight, wind, rain, weather, environmental conditions and atmospheric conditions; fire; vandalism; ordinary wear and tear; improper handling, storage, abuse or neglect of the Product or other damage to the Products that may result from deliberate act or negligence on the part of the customer, buyer, owner of the property where the Product is installed, installer or any third party.

Applicable Building Codes:

Applicable building codes and laws may dictate minimum the Product performance specifications, and the Manufacturer does not warrant the Product where the use, or installation, of the Product violates applicable building codes and laws.

Limiting of Liability:

At the time of manufacturing, the Product achieves the necessary values for the ANSI A137.1-2017 standards. Tests are performed on random samples of the Product by an independent testing laboratory and are believed to be representative of the general quality of the Product. To the fullest extent permitted under the law, under no circumstances will the Manufacturer be liable for incidental or consequential damages, whether such damages are sought in contract, in tort (including but not limited to negligence and strict liability) or otherwise, and the Product liability for non-personal injury claims with respect to products shall in no event exceed the replacement of such defective products or refund as set forth herein. Some States or Provinces do not allow the exclusion or limitation of incidental or consequential damages, so the above limitation or exclusion may not apply to you. This warranty gives you specific legal rights, and you may also have other rights that vary from State to State or Province to Province.

MAKING A WARRANTY CLAIM AND LIMITS ON LIABILITY:

To make a claim under this limited warranty, you must notify the Manufacturer in writing within fifteen (15) days of the discovery of the alleged manufacturing defect to the following address: **warranty@tanzite.com**

As a condition of this warranty, the following must be provided to the Manufacturer with written notice of a claim, failing which this warranty is voided and the Manufacturer released from any and all liability for the defect or the claim:

1. Provide satisfactory evidence of defects in the Product purchased, including but not limited to a description and photographs of the affected area of the Product.
2. Proof of purchase or assignment from the original end-user purchaser.
3. Proof of identity showing current address.

As a condition of this warranty proof of use, installation and maintenance, and care pursuant to the Manufacturer's Tanzite Owner's Manual, and Manufacturer's written specifications and industry standards must be provided to the Manufacturer upon its request, failing which this warranty is voided and the Manufacturer released from any and all liability for the defect or the claim. If a claim relating to a manufacturing defect and the improper staining of the Product, in addition to the foregoing, the following must be complied with prior to providing written notice of a claim to the Manufacturer, failing which this warranty is voided and the Manufacturer released from any and all liability for the defect or the claim:

- i. The affected area of the Product must be cleaned in accordance with the Manufacturer's written specifications.
- ii. If the affected area remains reasonably unsatisfactory after the affected area of the Product has been cleaned as set forth above, then the affected area of the Product must be professionally cleaned at the sole expense of the party making the claim or contemplating a claim.
- iii. If the affected area remains reasonably unsatisfactory after the professional cleaning, a claim may be made under this warranty, within fifteen (15) days of the professional cleaning.

If a valid warranty is made, it is at the Manufacturer's complete discretion which of the following will be provided:

1. Replacement of a portion of defective Product with same or equivalent product [with the cost for freight, labor, materials and costs for installation, maintenance or replacement not being covered by this warranty] as calculated below.
2. Repair or re-polish of the defective Product.
3. Refund a prorated portion of the original purchase price paid for such defective Product [but not including the cost for freight, labor, materials and costs for installation, maintenance or replacement of the Product] as calculated below.
4. Combination of the above provided that the Manufacturer's obligations are limited only to Product or parts of the Product that are proven to be defective pursuant to the terms of this warranty and the Manufacturer.

If a valid warranty claim hereunder is made, the percentage of such valid claim which the Manufacturer is required in its complete discretion to refund or replace pursuant to this warranty, shall commence the eleventh (11) year after the original date of purchase of the Product, and be reduced by five (5%) percent each year thereafter, reducing 5% each and every year until ten [10%] percent of the valid claim remains, at which time there shall be no further reduction to the percentage of the valid claims which the Manufacturer is required in its complete discretion to refund or replace pursuant to this warranty. For clarity, in no event shall the Manufacturer be required to refund any more than the prorated portion of the original purchase price or replace more than the prorated portion of the defective Product as calculated herein. In the event that the sole and exclusive remedy described above fails of its essential purpose, the liability of the Manufacturer is limited to the monetary value, on a square-foot (square-meter) basis, of the original purchase price of the Product or portion of the Product required to be replaced pursuant to the terms of this warranty. To the fullest extent permitted under the law, this warranty shall not cover and the Manufacturer shall not be responsible for costs and expenses, including but not limited to labor, costs, and freight, incurred with respect to the installation, maintenance, or removal of the Product or affected Product or the installation of replacement materials. The Manufacturer will not pay for the replacement of any portion of the installation that is not proven to be defective.

To the fullest extent permitted under the law, the costs and expenses incurred with respect to the removal and installation of the defective Product or the installation of replacement materials, including but not limited to freight, labor, and materials costs are excluded from this warranty. Should the Product used in the original installation no longer be readily available, the Manufacturer reserves the right to determine a suitable substitute but will only provide a replacement product for the defective Product and not the entire installation.

The Manufacturer reserves the right to inspect any and all defects prior to any repair, remediation or settlement of such defect. In the event that the Manufacturer within its sole discretion elects to or is otherwise required to participate in the repair, remediation or settlement of any defect, the Manufacturer must be included in all discussions and decisions related to such repair, remediation and/or settlement. In the event that the Manufacturer is not provided notice on a timely basis, or the Manufacturer is not allowed the right of inspection, discussion or decision-making in advance of repair, remediation or settlement of any defect, this warranty is voided and the Manufacturer released from any and all liability for the defect or the claim.

General Terms:

No amendment or variation of the terms, conditions warranties, covenants, agreements and undertakings set forth herein shall be of any force or effect unless the Manufacturer same shall be reduced to writing duly executed by the Manufacturer and the party purchasing the Product from the Manufacturer. Any provision in this warranty which is prohibited or unenforceable in any jurisdiction shall, as to such jurisdiction, be ineffective to the extent of such prohibition or unenforceability without invalidating the remaining provisions hereof or affecting the validity or enforceability of such provision in any other jurisdiction. The division of this warranty into Articles, Sections, Subsections, Schedules and other subdivisions, the inclusion of headings and the provision of a table of contents are for convenience of reference only and shall not affect the construction or interpretation of this warranty. The headings in the warranty are not intended to be full or precise descriptions of the text to which they refer.

We offer a complete returns service. See our returns policy in full on the website at www.tanzite.com/return-policy

In summary:

- You can return any* Tanzite product, for any reason whatsoever, within 90 days of placing your order.
- Any returns need to be in their original bundle/bag/carton and in good sellable condition.
- All returned products are subject to a 15% restocking fee.
- All shipping costs are the responsibility of the customer. They can not be refunded.

*Please note that EPDM membrane is not refundable as it is specifically cut for your project.

Damaged Product

Every Tanzite Stonedecks order has shipping insurance. To take advantage of this:

1. Take a photo of your shipment when it arrives.
2. Inspect it and take additional photos of any damage you find.
3. Notify us within 48 hours.

Tanzite is an extremely strong decking product, and frankly, it's hard to damage once installed. We manage our packaging and logistics very carefully, however there is still a small risk that it arrives with a chip or minor damage on the edge. These damaged stone flooring blocks can generally still be used as cut pieces or in hidden areas so there is minimal waste. If you are unable to make use of the damaged piece, let us know and we'll refund you for the cost of the damaged piece.

Extra Product

Please ensure that you are ordering enough extra product to account for wastage (allow 5-10% wastage depending on the design), late changes in the design/layout, or any slight mismeasurements.

Tanzite pieces aren't light or small, so shipping even just a few extra pieces typically costs more than the product itself, and the timescale for delivery is the same regardless of the quantity. If you need additional pieces, they can be ordered at Tanzite.com/shop-tanzite. Note that Tanzite does not cover the shipping costs if you need extra pieces.

DISCLAIMER:

This installation manual is provided for informational purposes only. The information contained herein is intended to provide general guidelines to simplify your project.

Tools, products, materials, techniques, building codes, and other regulations continually change, so Tanzite assumes no responsibility for the accuracy of the information contained herein and disclaims any liability for omissions, errors, or the outcome of any project.

Diagrams are approximations, not drawn to scale.

It is the responsibility of the installer or user to ensure compliance with all applicable laws, rules, codes and regulations, all manufacturers specifications, and Tanzite installation recommendations, in relation to their project.

The installer or user must take appropriate safety precautions to minimize the risk of harm to themselves or anybody else.

It is the responsibility of the homeowner to properly maintain and insure their project.

If there is any doubt regarding any element of a project, you should consult a licensed professional.



Tanzite

STONEDECKS