

# 5 Quick & Easy Steps to Instant Hot Water

See Installation, Care & Use Manual for important cautions and warnings



To see a tutorial of this installation:  
<http://goo.gl/AZOHu>

**AnswerLine®**  
 1-800-558-5700

## INSTALLING THE FAUCET

STEP 1 2 3 4 5

Indulge™ Contemporary, Antique, Tuscan  
 (GN/HC1100, GN/HC2200, GN/HC2215)

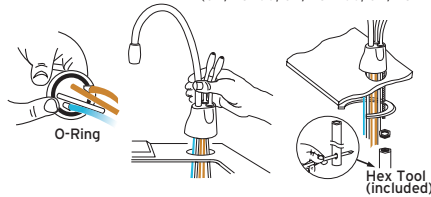

Hex Tool (included)

Indulge™ Modern  
 (H/HC3300)

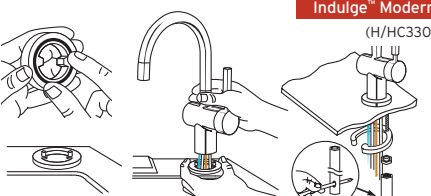

Hex Tool (included)

Involve™ View®, Wave®  
 (H/HC-View®, H/HC-Wave®)

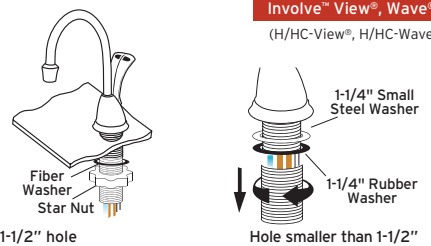

1-1/4" hole

Invite™ Contour™, Classic™  
 (H-Contour™, H-Classical™)

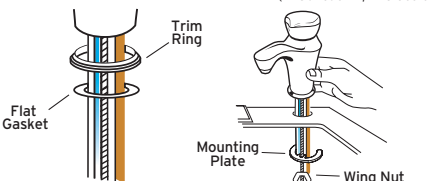

Invite Hot100™, Hot150™  
 (H-Hot100, H-Hot150)

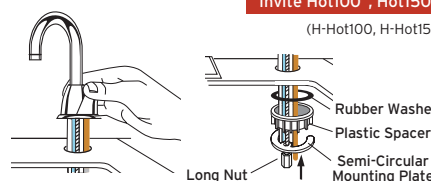

## MOUNTING THE TANK

STEP 1 2 3 4 5

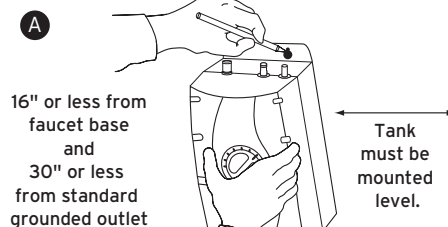

16" or less from faucet base and 30" or less from standard grounded outlet

Tank must be mounted level.

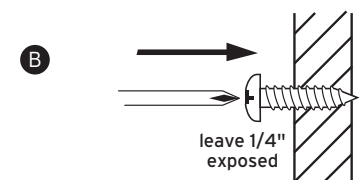

leave 1/4" exposed

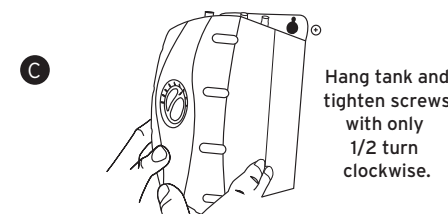

Hang tank and tighten screws with only 1/2 turn clockwise.

**DO NOT** extend plumbing or electrical lines

## CONNECTING FAUCET TO TANK

STEP 1 2 3 4 5

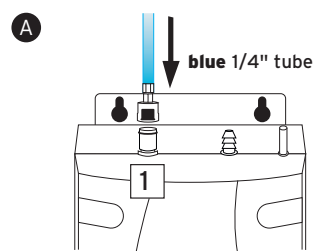

blue 1/4" tube

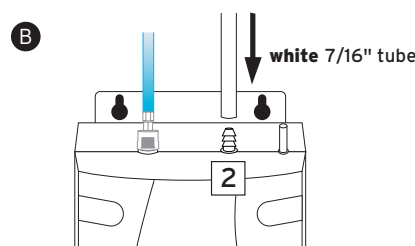

white 7/16" tube

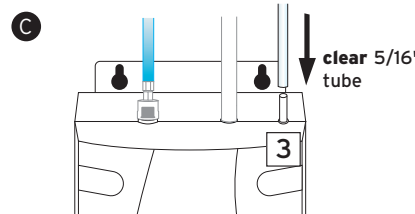

clear 5/16" tube

## IF INSTALLING FILTRATION SYSTEM

FILTRATION STANDARD WITH HWT-F1000S Available as an option. Separate purchase required.

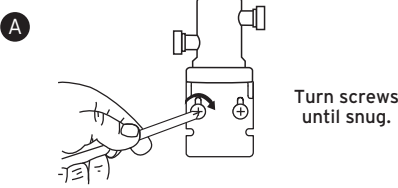

Turn screws until snug.

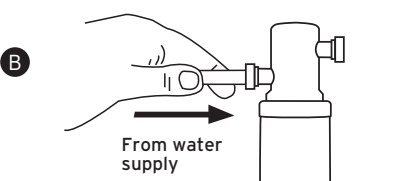

From water supply

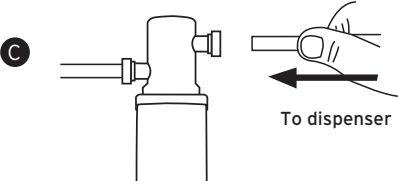

To dispenser

HC1100, HC2200, HC2215

GN1100, GN2200, GN2215, HC3300, H3300



From filter or water supply line

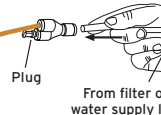

Plug From filter or water supply line

## FINAL WATER CONNECTION

STEP 1 2 3 4 5

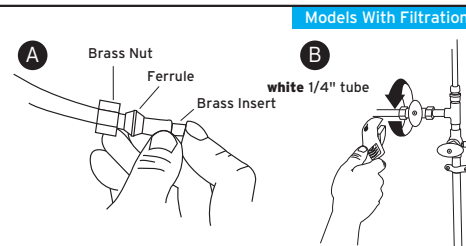

Models With Filtration

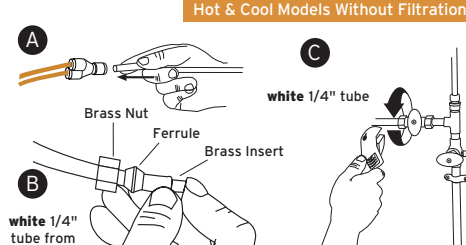

Hot & Cool Models Without Filtration

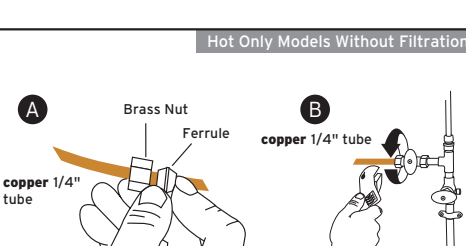

Hot Only Models Without Filtration

Press ALL tubes in once again to ensure secure fit.

**WARNING**

**Electric Shock Hazard:** This appliance MUST be grounded. Using an ungrounded appliance can result in serious injury or death from electric shock. Improper connection of the equipment grounding conductor can result in the risk of shock by electricity.

## FILL TANK & THEN CONNECT POWER

STEP 1 2 3 4 5

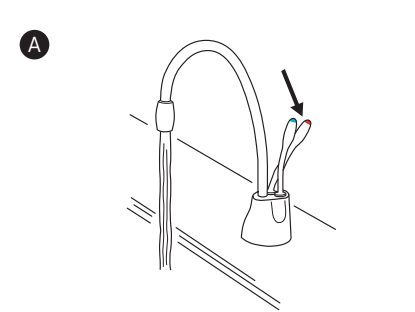

Run the water for at least 2 minutes to flush lines (both the hot and cold handles independently if applicable).

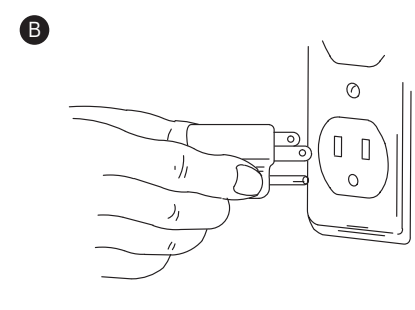

**DO NOT** plug in unit until water flows from faucet

**STOP** Please read Troubleshooting Guide and/or visit [www.insinkerator.com](http://www.insinkerator.com) before calling AnswerLine®

## TROUBLESHOOTING

| PROBLEM  | POSSIBLE CAUSE  | WHAT TO DO   |
|--|---|--|
| Water and steam spits forcefully from spout without turning on the dispenser faucet. | • Unit is boiling. May be normal during initial setup.  | • Activate faucet lever to release some water from the tank.<br>• Adjust water temperature using dial on tank front. Remember that at higher altitudes, water boils at lower temperatures. See Installation, Care & Use manual.  |
| Water is not hot.  | • The unit is unplugged.<br>• The electric outlet is inoperative.                                     | • Make sure the unit is connected to a properly grounded electric outlet.<br>• Make sure the circuit breaker or fuses are functioning properly.<br>• Check that the outlet is not switched off.  |
| Water is too hot or not hot enough.  | • Thermostat is not adjusted to your needs.   | • Adjust the thermostat slowly, then activate faucet lever for 20 secs. to bring in fresh water at the new setting. Allow 5-7 minutes for water to reach new temperature.  |
| Water comes out the vent instead of spout.   | • Outlet tube is blocked.   | • Check that outlet tube is not kinked, twisted or pinched.<br>• Unscrew spout end piece and clean out any debris.   |
| Water is dripping from the spout/vent intermittently.                                | • The expansion chamber isn't draining properly due to low water pressure.<br>• The spout is blocked. | • Unplug the unit. If the dripping doesn't stop after a few minutes, check the supply valve to ensure that it is fully open and there are no obstructions in the water line reducing the pressure below 30 psi (i.e., a poorly mounted saddle valve, a clogged water filter, or a partially opened shut-off valve).<br>• Unscrew spout end piece and clean out any debris. |
| Water is dripping from the spout/vent constantly.                                    | • Debris in the water line may be in the faucet valve seat causing a slow water leak.                 | • Unscrew spout end piece and clean out any debris.<br>• Activate faucet lever 7-10 times to flush faucet & lines.   |
| Divided stream.  | • Debris in the end piece.  | • Unscrew spout end piece and clean out any debris.  |
| Water continues to run after releasing lever. (Involve™ View®/Involve™ Wave®)        | • Mounting nut too tight.<br>• Mounting washer not installed properly.                                | • Loosen mounting nut, 1/4 turn at a time, until shut-off occurs.<br>• See Installation, Care & Use manual to check proper mounting washer installation options.   |
| Water discoloration/rusty appearance.  | • Corrosion of unit.  | • Unplug and drain unit as described in the Seasonal Storage/Drainage section of the Owner's Manual. If the water discoloration remains after draining and refilling unit, discontinue use and contact an authorized InSinkErator service agent.   |

## FILTRATION ISSUES (Filtration available as an option)

|                                  |  |   |
|----------------------------------|--|---|
| Water taste or odor.             | • Filter needs to be flushed out.<br>• Life of filter has expired. | • Activate faucet lever and run until the water is cold. If no change, replace filter cartridge.  |
| New filter leaks or doesn't fit. | • Head & bracket not fully rotated.<br>• Filter O-ring breach.     | • Remove, inspect, reinstall filter cartridge.<br>• Remove new filter, replace with old filter. Check operation. If OK, reinstall new filter and recheck operation. |
| No water flow or low water flow. | • Life of filter has expired.                                      | • Replace filter cartridge.   |

If you are still experiencing trouble, visit [www.insinkerator.com](http://www.insinkerator.com) or call the AnswerLine® 1-800-558-5700.

An instant hot water dispenser, like any water heater, has a limited life and will eventually fail. To avoid possible property damage and personal injury, this instant hot water dispenser should be regularly examined for leakage and/or corrosion and replaced when necessary. A drain pan, plumbed to an appropriate drain or outfitted with a leak detector, should be used in those applications where any leakage could cause property damage. To check for corrosion, examine the appearance of the dispensed water in a clear glass once every three (3) months. If there is any discoloration or rusty appearance, unplug and drain unit as described in the Seasonal Storage/Drainage section of the Owner's Manual. If the water discoloration remains after draining and refilling unit, discontinue use and contact an authorized InSinkErator service agent.

## IN-HOME FULL SERVICE LIMITED WARRANTY

|            |  |  |
|------------|--|--|
| Dispenser: | Indulge Series<br>Involve Series<br>Invite Contour/Classic<br>Invite Hot100/Hot150 | 5-year warranty<br>3-year warranty<br>3-year warranty<br>1-year warranty |
|------------|--|--|

|                    |                               |   |
|--------------------|-------------------------------|---|
| Hot Water Tank:    | Hot100 Series Hot Water Tank: | 3-year warranty<br>1-year warranty                |
| Filtration System: |                               | 1-year warranty (excluding replaceable cartridge) |

This limited warranty is provided by InSinkErator, a business unit of Emerson Electric Co., ("InSinkErator" or "Manufacturer" or "we" or "our" or "us") to the original consumer owner of the InSinkErator product with which this limited warranty is provided (the "InSinkErator Product"), and any subsequent owner of the residence in which the InSinkErator Product was originally installed ("Customer" or "you" or "your").

InSinkErator warrants to Customer that your InSinkErator Product will be free from defects in materials and workmanship, subject to the exclusions described below, for the "Warranty Period", commencing on the later of: (a) the date your InSinkErator Product is originally installed, (b) the date of purchase, or (c) the date of manufacture identified by your InSinkErator Product. You will be required to show written documentation supporting (a) or (b). If you are unable to provide documentation supporting either (a) or (b), the Warranty Period commencement date will be determined by Manufacturer, in its sole and absolute discretion, based upon your InSinkErator Product serial number.

### Permitted Uses

You may use your InSinkErator Product hot/cold water tank and filter system in combination with any genuine InSinkErator Product instant hot water dispensers and component parts and/or Authorized OEM Products. "Authorized OEM Products" mean those hot or hot/cold water dispensers and component parts that have been manufactured by an authorized InSinkErator original equipment manufacturer ("Authorized OEM") and which have documentation expressly stating that such Authorized OEM Products are compatible with the InSinkErator Product(s). Authorized OEMs may change from time to time. A list of Authorized OEMs is available to you upon request or at: [www.insinkerator.com/oem](http://www.insinkerator.com/oem). Use of your InSinkErator Product in combination with any products other than Authorized OEM Products will void this warranty.

### What is Covered

This limited warranty covers defects in materials or workmanship, subject to the exclusions below, in InSinkErator Products used by a consumer Customer for residential use only, and includes all replacement parts and labor costs. **YOUR SOLE AND EXCLUSIVE REMEDY UNDER THIS LIMITED WARRANTY SHALL BE LIMITED TO REPAIR OR REPLACEMENT OF THE INSINKERATOR PRODUCT, PROVIDED THAT IF WE DETERMINE IN OUR SOLE DISCRETION THAT NEITHER REMEDY IS PRACTICABLE, WE MAY PROVIDE YOU A REFUND OF YOUR PURCHASE PRICE OR A CREDIT TOWARDS ANOTHER INSINKERATOR PRODUCT.**

### What is not Covered

This limited warranty does not extend to and expressly excludes:

- Losses or damages or the inability to operate your InSinkErator Product resulting from conditions beyond the Manufacturer's control including, without limitation, accident, operation, misuse, abuse, neglect, negligence (other than Manufacturer's), failure to install, maintain, assemble, or mount the InSinkErator Product in accordance with Manufacturer's instructions or local electrical and plumbing codes.
- Wear and tear expected to occur during the normal course of use, including without limitation, cosmetic rust, scratches, dents or comparable and reasonably expected losses or damages.
- Losses or damages caused by any product or component part used with the InSinkErator Products, including both Authorized OEM Products and other products and components.

In addition to the above exclusions, this warranty does not apply to InSinkErator Products installed in a commercial or industrial application.

### No Other Express Warranty Applies

This limited warranty is the sole and exclusive warranty provided to the Customer identified above. No other express warranty, written or verbal, applies. No employee, agent, dealer, or other person is authorized to alter this limited warranty or make any other warranty on behalf of Manufacturer. The terms of this limited warranty shall not be modified by the Manufacturer, the original owner, or their respective successors or assigns.

### What we will do to Correct Problems

If your InSinkErator Product does not operate in accordance with the documentation provided to you, or you have questions concerning your InSinkErator Product or how to determine when service is needed, please call the toll free InSinkErator AnswerLine® at 1 (800) 558-5700, or visit our website at [www.insinkerator.com](http://www.insinkerator.com). You may also notify us at: InSinkErator Service Center, 4700 21st Street, Racine, Wisconsin 53406 USA.

The following information must be provided as part of your warranty claim: your name, address, phone number, your InSinkErator Product model and serial number, and if necessary, upon request, written confirmation of either: (a) the date shown on your installation receipt, or (b) the date shown on your purchase receipt.

Manufacturer or its authorized service representative will determine, in its sole and absolute discretion, if your InSinkErator Product is covered under this warranty. You will be given the contact information for your closest authorized InSinkErator Service Center. Please contact your InSinkErator Service Center directly to receive in home warranty repair or replacement service. Only an authorized InSinkErator service representative may provide warranty service. InSinkErator is not responsible for warranty claims arising from work performed on your InSinkErator Product by anyone other than an authorized InSinkErator service representative.

If a covered claim is made during the Warranty Period, Manufacturer will, through its authorized service representative, either repair or replace your InSinkErator Product. Cost of replacement parts or a new InSinkErator Product, and cost of labor for repair or installation of the replacement InSinkErator Product are provided at no cost to you. Repair or replacement shall be determined by Manufacturer or its authorized service representative in their sole discretion. All repair and replacement services will be provided to you at your home. If Manufacturer determines that your InSinkErator Product must be replaced rather than repaired, the warranty on the replacement InSinkErator Product will be limited to the unexpired term remaining in the original Warranty Period.

This instant hot water dispenser is covered by Manufacturer's limited warranty. This limited warranty is void if you attempt to repair the InSinkErator Product. For service information, please visit [www.insinkerator.com](http://www.insinkerator.com) or call, toll free, 1-800-558-5700.

### Limitation of Liability

TO THE EXTENT PERMITTED BY LAW, IN NO EVENT SHALL MANUFACTURER OR ITS AUTHORIZED SERVICE REPRESENTATIVES BE LIABLE FOR ANY INCIDENTAL, SPECIAL, INDIRECT, OR CONSEQUENTIAL DAMAGES, INCLUDING ANY ECONOMIC LOSS, WHETHER RESULTING FROM NONPERFORMANCE, USE, MISUSE OR INABILITY TO USE THE INSINKERATOR PRODUCT OR THE MANUFACTURER'S OR ITS AUTHORIZED SERVICE REPRESENTATIVE'S NEGLIGENCE. MANUFACTURER SHALL NOT BE LIABLE FOR DAMAGES CAUSED BY DELAY IN PERFORMANCE AND IN NO EVENT, REGARDLESS OF THE FORM OF THE CLAIM OR CAUSE OF ACTION (WHETHER BASED IN CONTRACT, INFRINGEMENT, NEGLIGENCE, STRICT LIABILITY, OTHER TORT OR OTHERWISE), SHALL MANUFACTURER'S LIABILITY TO YOU EXCEED THE PRICE PAID BY THE ORIGINAL OWNER FOR THE INSINKERATOR PRODUCT.

The term "consequential damages" shall include, but not be limited to, loss of anticipated profits, business interruption, loss of use or revenue, cost of capital or loss or damage to property or equipment.

Some states do not allow the exclusion or limitation of incidental or consequential damages, so the above limitation may not apply to you. This limited warranty gives you specific legal rights and you may also have other rights which vary from state to state.



1.800.558.5700

[www.insinkerator.com](http://www.insinkerator.com)

ISE 44790 REV C

The Emerson logo is a trademark and a service mark of Emerson Electric Co.

InSinkErator may make improvements and/or changes in the specifications at any time, in its sole discretion, without notice or obligation and further reserves the right to change or discontinue models.

©2014 InSinkErator, a business unit of Emerson Electric Co. All Rights Reserved.



CONTEMPORARY  
ANTIQUÉ  
TUSCAN  
MODERN



View®  
Wave®



Contour™  
Classic™  
Hot100™  
Hot150™

# Quick Install Guide

## Instant Hot Water Dispensers



To see a tutorial of this installation:

<http://goo.gl/AZOuH>



## What You Should Know Before Beginning

This is a quick reference guide. Please refer to the complete Installation, Care & Use Manual for specifics including cautions and warnings. If after reading the troubleshooting section, you still have questions about parts, installation or warranty, please visit [www.insinkerator.com](http://www.insinkerator.com) or call the AnswerLine®.

**AnswerLine®**  
1-800-558-5700

M-F 7a.m. to 8 p.m. (Central)  
Sat./Sun. 9 a.m. to 6 p.m.

Please have the model and serial number of your tank and faucet available when calling. Visit [www.insinkerator.com](http://www.insinkerator.com) for assistance on many common questions.

## Starting the Installation Process

- A continuous electrical power source (not controlled by a wall switch) is required to power the unit.
- Ensure that there is sufficient space to fit the unit under the sink and around existing plumbing.
- The sink hole diameter required for installation varies by model:
  - HC1100, HC2200, HC2215 and H/HC3300: 1-3/8" - 1-1/2"
  - GN1100, GN2200 and GN2215: 1-1/4" - 1-1/2"
  - HC/H-View and HC/H-Wave: 1-1/4" - 1-1/2"
  - H-Contour, H-Classic, Hot100 and Hot150: 1-1/4" - 1-1/2"

Many installers choose to use the existing "sprayer" hole.

- Check to make sure that a cold water supply line is within reach of the water inlet line.

## PREPARATION

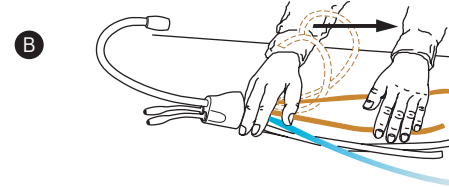
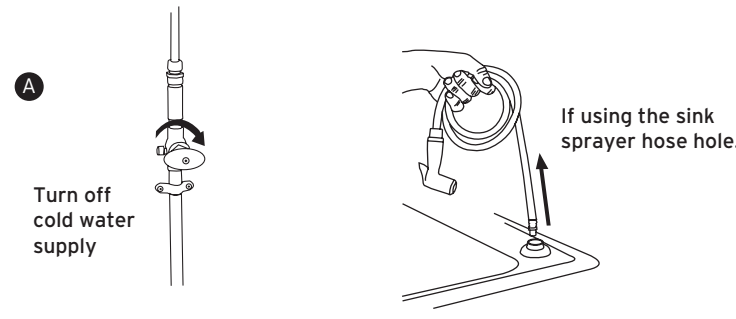

## TYPICAL COMPLETE INSTALLTION

Hot & cool model shown

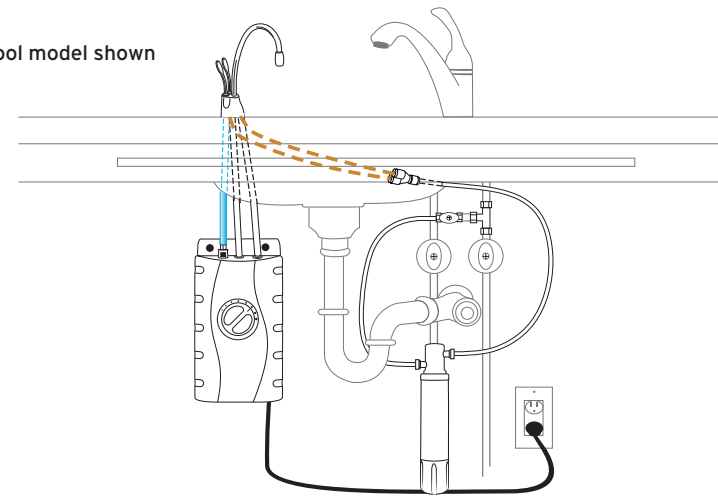

### WARNING

**BEFORE INSTALLING REPLACEMENT DISPENSER**

**Personal Injury:** Unplug the tank. Depress the dispenser handle for about one minute so cold water can flow through the unit. This cools the water for safer removal of existing tank and dispenser.