

Snowflake Design 1

Tools Required To Make this Design:

Punching: Practical Punch/Shear (or Master Punch/Shear or XL5+ Power Bender fitted with 3mm Punch Block & Pins)
 Cutting: Practical Punch/Shear (or Master Punch/Shear or XL5+ Power Bender)
 Riveting: Practical RBR
 Bending: Practical RBR
 Twisting: Practical Twister fitted with Adaptor

We recommend that before starting you wipe all steel bars down so that they are free of grease, scale or dirt. After cutting any component, we also recommend that you trim the corners for a neater finish, if preferred, unless these instructions tell you otherwise. Use a fine tip marker pen, pencil or scribe for marking hole, bend, scroll, roll points on the bars.

Component 1 Hexagon (x1)

12mm x 2mm x150mm

Cut a length of 150mm out of 12mm x 2mm material but do not trim the corners. Using the Design Sheet overleaf, mark the 5 bend points B1. Then using an outcut set the RBR to bend an angle of 120° using Template 1 as a guide. Then bend this angle at all the positions B1 on component 1 to form the hexagon shape centre of the snowflake.

Component 2 Radial Arms (x6)

12mm x 2mm x 152mm

Take one 914mm length of 12mm x 2mm and cut 6 pieces at 152mm. The last piece may be fractionally longer by the odd mm but this does not matter. Using the Design Sheet overleaf mark hole positions H1, H2 and H3 and bend position B2. Start by punching these three holes on the Punch & Shear tool. Then bend a 90° angle at B2 using template 2 as a guide.

Component 3 Twisted Branch(x12)

12mm x 2mm x 152mm

Take two full 914mm lengths of material and cut 12 pieces at 152mm. Using the Design Sheet overleaf mark hole position H1 and bend position B3. Start by punching a hole at H1 and then bend a 130° angle at B3 using template 3 as a guide.

Then make sure the Practical Twister is set up with its adaptor collar and slide. Arrange the component as shown in the photo below with bend B3 at the back of the slide and approx 7mm of the end of the bar in the collar. Rotate the twister handles through one complete rotation 360°.

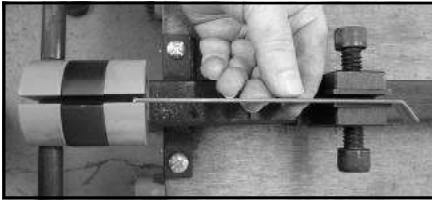

Component 4 Small Branch (x12)

12mm x 2mm x 70mm

Then cut 12 more pieces each 70mm long out of 12mm x2mm material. Using the Design Sheet overleaf mark the bend position B3 and hole positions H2. Bend a 130° angle at B3 again using Template 3 and then punch Hole 2.

Assembly

Firstly take a pair of small branches and align these to a radial arm as shown in the picture on the front of these instructions and align the three holes H2 with an 8mm x 3mm rivet. Repeat process using the large twisted branches aligning the holes H1.

Then complete the other 5 radial arms in the same way.

Finally arrange the radial arms with the branches on around the hexagon as shown in the picture below so that the arms are central to each side of the hexagon. Mark where hole H3 on the radial arm touches each face of the hexagon and then punch these.

Finally rivet these in place using 6mm x 3mm rivets.

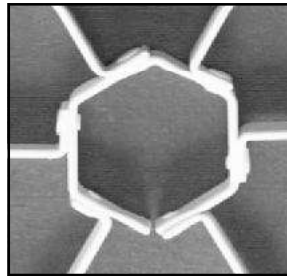

The finished item can be painted in a variety of finishes (smooth, satin, hammer or metallic) either by aerosol or by brush application. The finished item can then be then fixed back to a wall or suspended from a high ceiling as a mobile decoration.

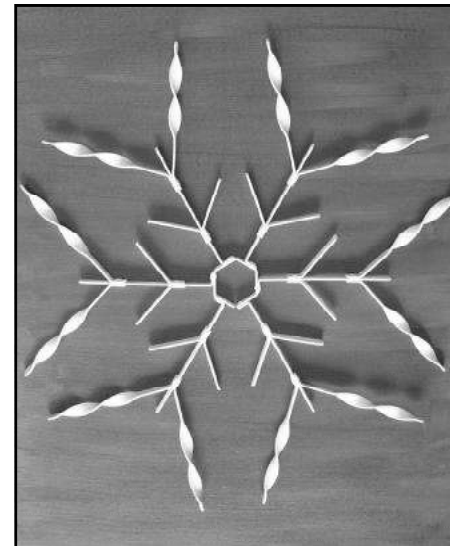
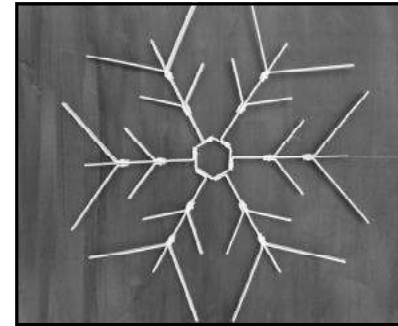

metalcraft™

Design Pack

Snowflake Design 1

Special Note - The material provided in the overall design pack is sufficient to enable you to make any two of the four designs included in this pack.

Difficulty Rating:	
Easy	✓
Straightforward	
More complex	



As an alternative, you can elect to not bother twisting the large branch as shown in the image here.
 This cleverly designed icicle wall art is a great way to decorate your home, office or workplace this Christmas.
 Hang them up on the wall or from a ceiling and let people see your handy work.

GENERAL NOTE

Design Pack: Snowflake 1 - Design Sheet

Not to Scale:

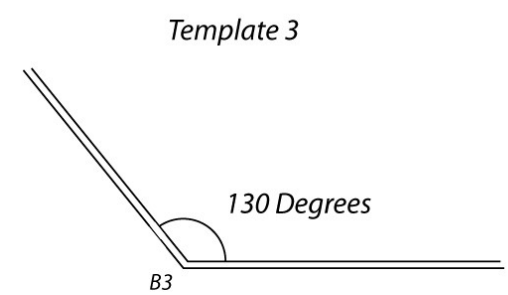
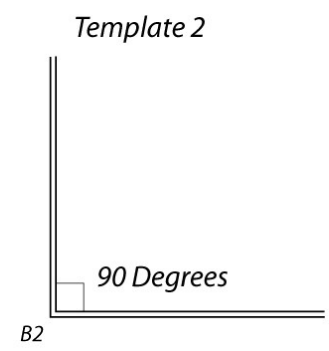
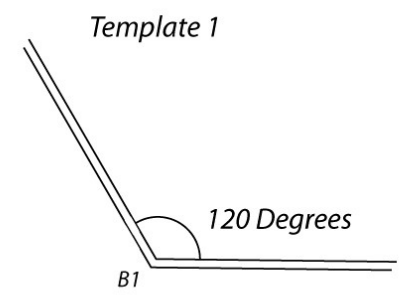
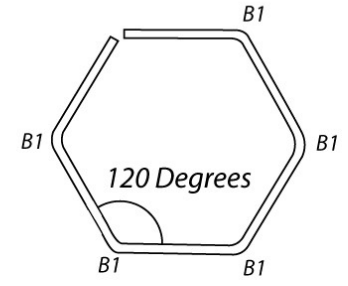
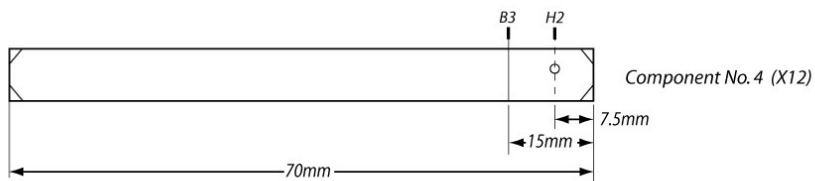
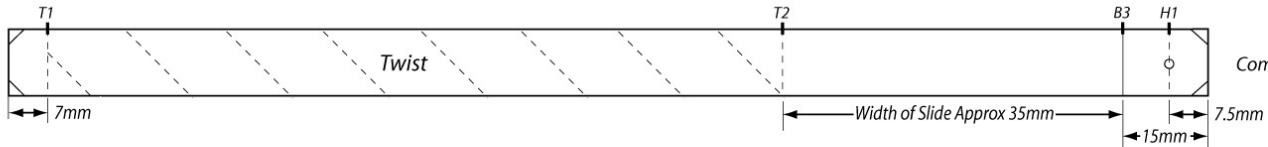
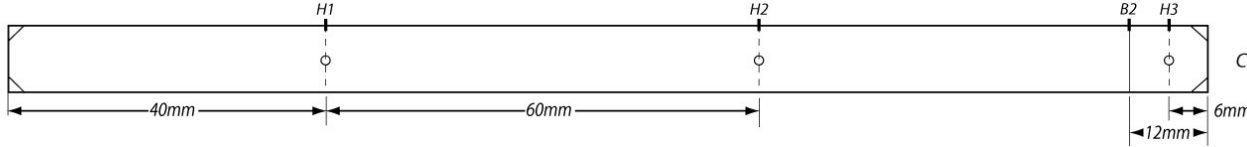
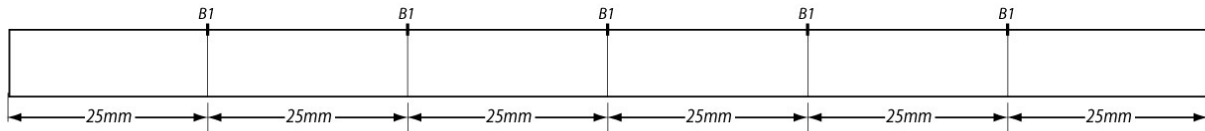

List of Materials

- 5 Lengths x 12mm x 2mm x 3ft [Re-Order Ref: MC034]
- 12 x 8mm x 3mm Rivets [Re-Order Ref: MC051L]
- 6 x 6mm x 3mm Rivets [Re-Order Ref: MC050L]

Snowflake Design 2

Tools Required To Make this Design:

Punching: Practical Punch/Shear (or Master Punch/Shear or XL5+ Power Bender fitted with 3mm Punch Block & Pins)
 Cutting: Practical Punch/Shear (or Master Punch/Shear or XL5+ Power Bender)
 Riveting: Practical RBR
 Bending: Practical RBR

We recommend that before starting you wipe all steel bars down so that they are free of grease, scale or dirt. After cutting any component, we also recommend that you trim the corners for a neater finish, if preferred, unless these instructions tell you otherwise. Use a fine tip marker pen, pencil or scribe for marking hole, bend, scroll, roll points on the bars.

Component 1 **Radial Arm (x6)**
 12mm x 2mm x380mm

Take three 914mm lengths of 12mm x 2mm and cut 6 pieces at 380mm long. Using the Design Sheet overleaf mark bend positions B1 to B5

Then mark the hole positions H1 and H2
 Then start by punching these.

Next, set the RBR tool to bend an angle of 90° using Template 1A and bend this angle at position B1.

Then set the RBR to bend an angle of 120° at positions B4 and B5 at using Template 1C.

Finally, reset the RBR tool to bend an angle of 128° using Template 1B and bend at positions B2 and B3

The resulting component should be similar to that shown in Template 1.

Repeat for the other 5 radial arms

Component 2 **Small Branches (x12)**
 12mm x 2mm x130mm

Start by cutting 12 pieces at 130mm long out of 12mm by 2mm material. Using the design sheet over leaf mark the bend position B6 and the hole position H2.
 Bend a 136° angle at B6 using template 1D and then punch hole at H2

Assembly

Start by taking one radial arm and riveting two of the small branches to it at Hole H2 as per Template 1 using 6mmx 3mm rivets. Repeat with the other five radial arms and their branches.

Then arranging the radial arms up to each other as shown in the image on the front cover. All holes should meet up again when you insert a 6mm x 3mm rivet to join each radial arm to the next.

If necessary adjust any bends by putting the components back into the RBR tool and adjusting where necessary .

Then progressively rivet each joint using 6mm x 3mm rivets to form your snowflake.

The finished item can be painted in a variety of finishes (smooth, satin, hammer or metallic) either by aerosol or by brush application. The finished item can then be then fixed back to a wall or suspended from a high ceiling as a mobile decoration.

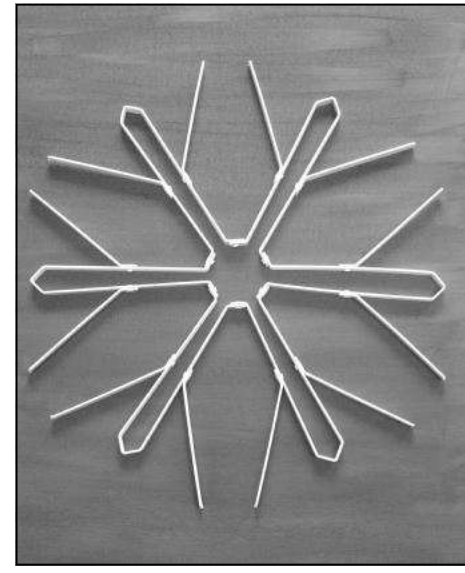

Design Pack Snowflake Design 2

Special Note - The material provided in the overall design pack is sufficient to enable you to make any two of the four designs included in this pack.

Difficulty Rating:	
Easy	✓
Straightforward	
More complex	

Design Pack: Snowflake 2 - Design Sheet

Not to Scale:

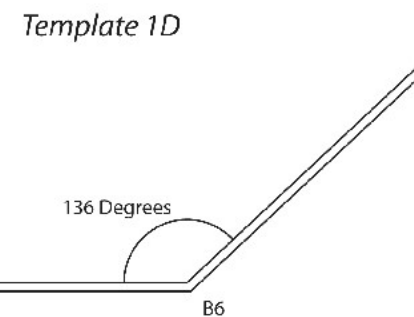
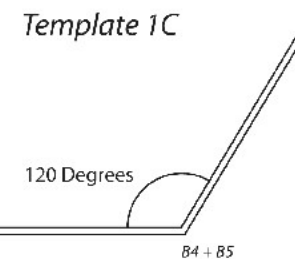
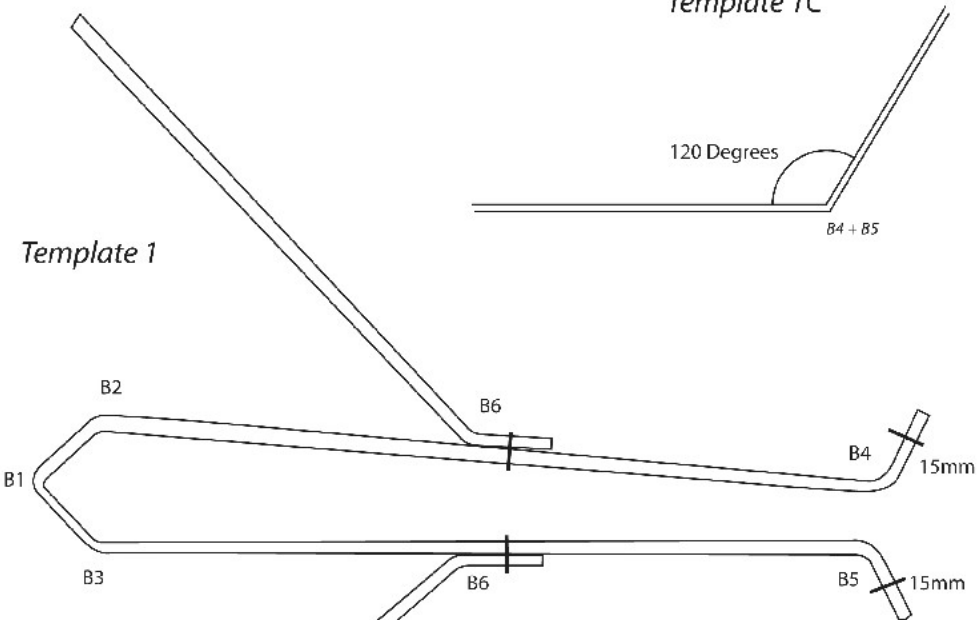
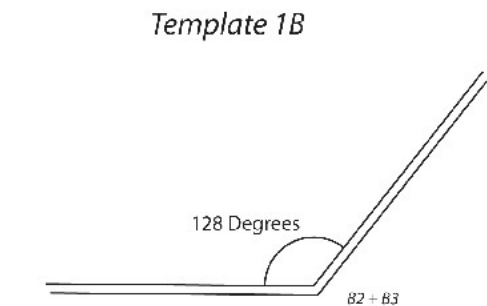
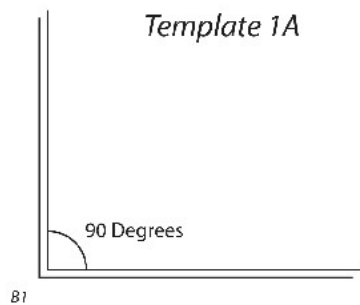
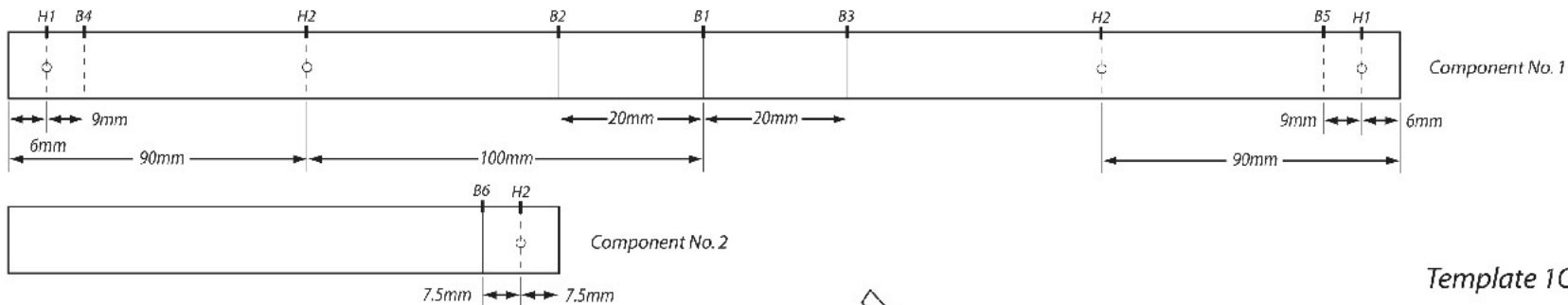

List of Materials

5 Lengths x 12mm x 2mm x 3ft [Re-Order Ref: MC034]

18 x 6mm x 3mm Rivets [Re-Order Ref: MC050L]

Snowflake Design 3

Tools Required To Make this Design:

Punching: Practical Punch/Shear (or Master Punch/Shear or XL5+ Power Bender fitted with 3mm Punch Block & Pins)
 Cutting: Practical Punch/Shear (or Master Punch/Shear or XL5+ Power Bender)
 Riveting: Practical RBR
 Bending: Practical RBR

We recommend that before starting you wipe all steel bars down so that they are free of grease, scale or dirt. After cutting any component, we also recommend that you trim the corners for a neater finish, if preferred, unless these instructions tell you otherwise. Use a fine tip marker pen, pencil or scribe for marking hole, bend, scroll, roll points on the bars.

General Note

Of all the Snowflake designs this is the easiest to make as it has only one component and involves just cutting, punching, bending and riveting. It is a good starting point for complete novices.

Component 1 Radial Arm (x6) 12mm x 2mm x 390mm

Take three 914mm lengths of 12mm x 2mm and cut 6 pieces at 390mm long. Using the Design Sheet overleaf mark bend positions B1 to B5 on one side of the bar and bend positions B6 to B9 on the reverse side of the bar.

Then mark the two hole positions H1 and start by punching these.

Next, set the RBR tool to bend an angle of 110° using Template 1 and bend this at B9 & B8.

Then, reset the RBR tool to bend an angle of 156° using Template 3 and bend this at B6 & B7.

When this is complete, flip the bar over so that you are ready to bend on the reverse side. Reset the bend angle to 130° using Template 2 and then bend in the order B1, B2, B3, B4, and finally B5.

The resulting component should be very similar to that shown in Template 4.

Repeat for the other 5 radial arms

Assembly

Start by arranging the radial arms as shown in the image on the front cover. All holes should meet up when you insert a 6mm x 3mm rivet to join each radial arm to its neighbour. If necessary adjust any bends by putting the components back into the RBR tool and bending at B1 or B8/B9.

Then progressively rivet each joint using 6mm x 3mm rivets to form your snowflake.

The finished item can be painted in a variety of finishes (smooth, satin, hammer or metallic) either by aerosol or by brush application. The finished item can then be then fixed back to a wall or suspended from a high ceiling as a mobile decoration.

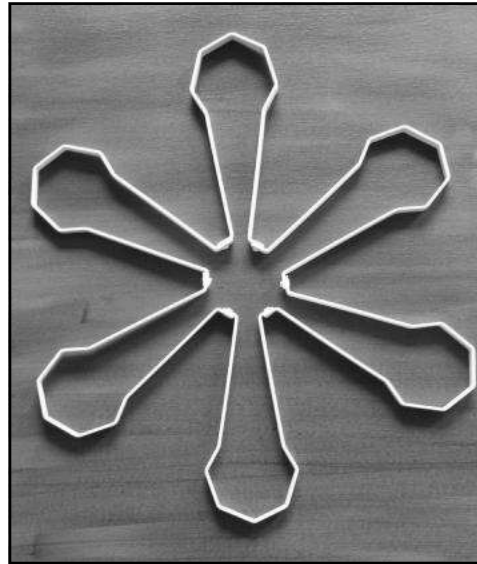

metalcraft[™]

Design Pack

Snowflake Design 3

Special Note - The material provided in the overall design pack is sufficient to enable you to make any two of the four designs included in this pack.

Difficulty Rating:

Easy	<input checked="" type="checkbox"/>
Straightforward	<input type="checkbox"/>
More complex	<input type="checkbox"/>



Design Pack: Snowflake 3 - Design Sheet

Not to Scale:

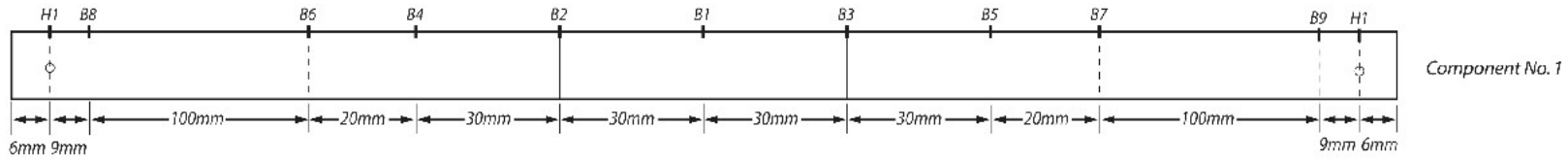

Template 1

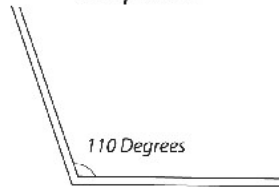

Template 2

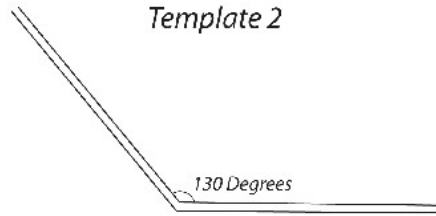

Template 3

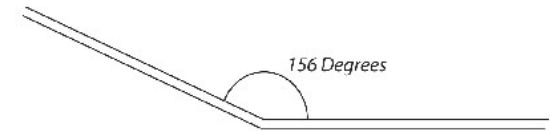

Template 4

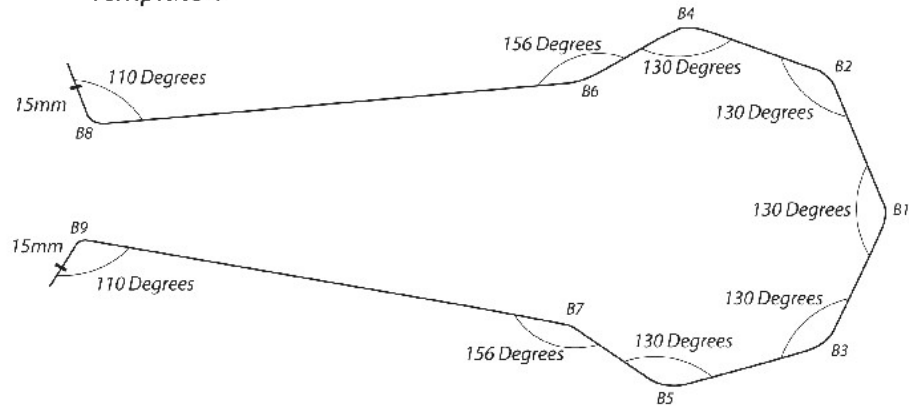

List of Materials

3 Lengths x 12mm x 2mm x 3ft [Re-Order Ref: MC034]

6 x 6mm x 3mm Rivets [Re-Order Ref: MC050L]

Snowflake Design 4

Tools Required To Make this Design:

Punching: Practical Punch/Shear (or Master Punch/Shear or XL5+ Power Bender fitted with 3mm Punch Block & Pins)
 Cutting: Practical Punch/Shear (or Master Punch/Shear or XL5+ Power Bender)
 Riveting: Practical RBR
 Bending: Practical RBR
 Scrolling: Mk1/2 Scroll Former & Mk2/2H (or Mk 2/3)

We recommend that before starting you wipe all steel bars down so that they are free of grease, scale or dirt. After cutting any component, we also recommend that you trim the corners for a neater finish, if preferred, unless these instructions tell you otherwise. Use a fine tip marker pen, pencil or scribe for marking hole, bend, scroll, roll points on the bars.

Component 1 Hexagon (x1) 12mm x 2mm x240mm

Cut a length of 240mm out of 12mm x 2mm material but do not trim the corners. Using the Design Sheet overleaf, mark the 5 bend points B1. Then using the RBR to bend an angle of 120° using Templates 1A & 1B as a guide. Then bend this angle at all the positions B1 on component 1 to form the hexagon shape centre of the snowflake.

Component 2 Large Scroll (x12) 12mm x 2mm x 260mm

Take four 914mm lengths of 12mm x 2mm and cut 12 pieces at 260mm long. Using the Design Sheet overleaf mark positions H1, H2, B1 and S1. Start by punching holes at H1 & H2. Next, use the Mk2/2H (or Mk2/3) to form a scroll until the S1 mark on the steel just touches the segment of the tool. Finally bend a 90° angle at B2 using template 2 as a guide and taking care to bend it the right way (see Template 3).

Component 3 Small Scroll (x12) 12mm x 2mm x 125mm

Using the offcut from Component 1 plus a full 914mm length, cut 12 pieces at 125mm. Using the Design Sheet overleaf mark hole position H2 and scroll position S2. Start by punching a hole at H2 and then use the Mk1/2 scroll former to form a scroll until the S2 mark on the steel just touches the segment of the tool and the resulting piece should look like Template 4.

Assembly

Take a pair of Large Scrolls (Component 2) and lay them back to back so holes H2 line up.

Then add a pair of small scrolls (Component 3) and line up the holes H2 on these with those in the two Large Scrolls as shown in the image opposite. Then put a 12mm x3mm rivet in and rivet together.

Repeat for the other 5 sets of large and small scrolls.

Assembly (Cont'd)

Finally offer each set of riveted scroll sets up to the central hexagon as shown in the picture on the front cover and mark where each pair of Holes H1 touch the Hexagon. Punch each pair of holes in the Hexagon and rivet a scroll set in place using the 6mm x 3mm rivets provided, progressively working round the other 5 sides of the hexagon in the same manner.

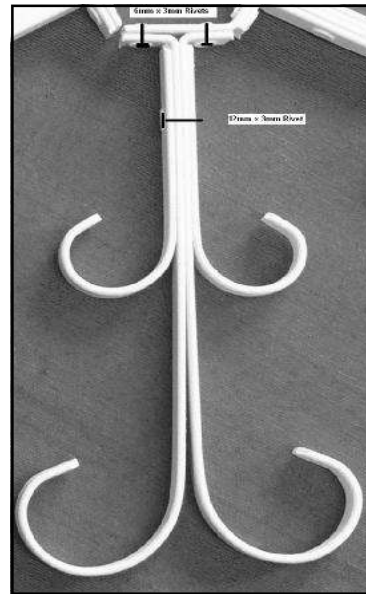

The finished item can be painted in a variety of finishes (smooth, satin, hammer or metallic) either by aerosol or by brush application. The finished item can then be then fixed back to a wall or suspended from a high ceiling as a mobile decoration.

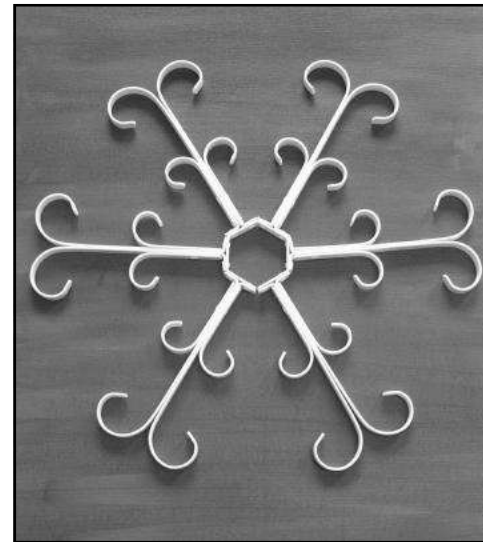

metalcraft™

Design Pack

Snowflake Design 4

Special Note - The material provided in the overall design pack is sufficient to enable you to make any two of the four designs included in this pack.

Difficulty Rating:	
Easy	✓
Straightforward	
More complex	



Design Pack: Snowflake 4 - Design Sheet

Not to Scale:

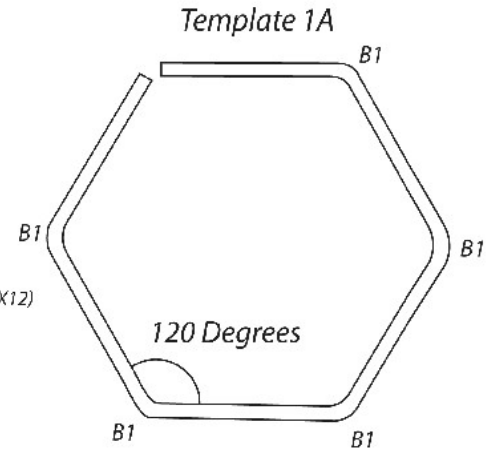
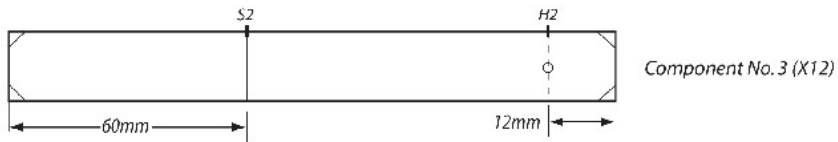
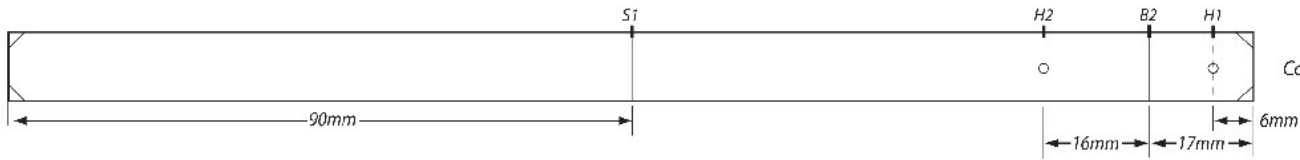
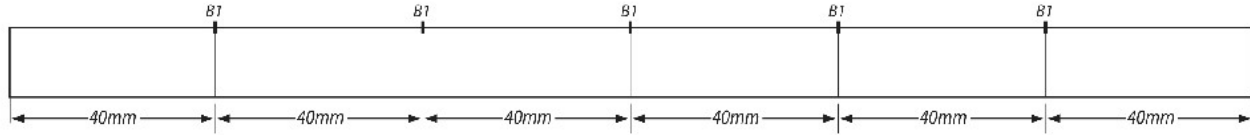

Template 1B

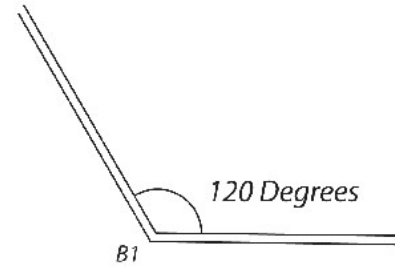

Template 2

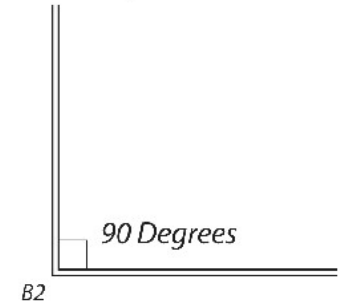

List of Materials

6 Lengths x 12mm x 2mm x 3ft [Re-Order Ref: MC034]

6 x 12mm x 3mm Rivets [Re-Order Ref: MC053L]

12 x 6mm x 3mm Rivets [Re-Order Ref: MC050L]

Template 3

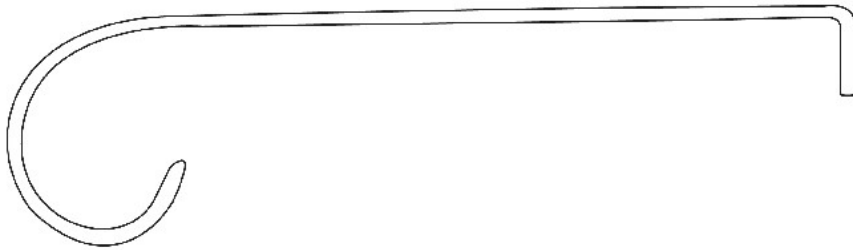

Template 4

