



Two-Speed Geothermal Heat Pump Series

Installation and Operation Manual



Table of Contents

Contact Information	4
Model Nomenclature	5

Technical Data	6
Transportation and Storage	8
Electrical Hazards	9
System Installation	10
Ductwork Considerations	11
Ground Loop System	12
Open Loop System	14
Condensate Considerations	17
DHW PLumbing	18
High and Low Voltage Wiring	19
Dallas Microprocessor	21
DEC Star Blower	25
Start Up Procedures	26
Preventive Maintenance	27
Troubleshooting	29
Wiring Diagram	31



Geocool - All rights reserved

Geocool® has compiled this manual with care; however Geocool does not warrant that the

information in this manual is free of errors. Geocool reserves the right to change any portion of this manual without notice. The appearance of any technical data or editorial material in this manual does not constitute endorsement, warranty, or guarantee by Geocool of any product, service, process, procedure, design, or the like. The user assumes the entire risk of the use of any information in this manual.

Contact Information:

Geocool
48 Remington Way
Hickory, Ky 42051
www.geo.cool

DO NOT install, operate, or maintain this equipment before carefully reading this instruction manual.

Additional copies of this manual are available from the installing dealer or from Geocool.

Save the manual and any other operating instructions for yourself and any future owners of this equipment.

A trained Geocool installer must perform all installation practices.

A licensed refrigeration technician must perform all refrigeration repairs / modifications. Geocool must approve all service repairs if system is covered under manufacturer warranty

Unless otherwise noted in the terms outlined in the warranty, you must register your product at one of the following links to receive the additional 5 years of Geocool product warranty:

English: <http://geo.cool/your-warranty/residential/geocool-warranty-reg.html>

Espanol: <http://geo.cool/your-warranty/residential/spanish/geocool-warranty-reg.html>

MODEL NOMENCLATURE

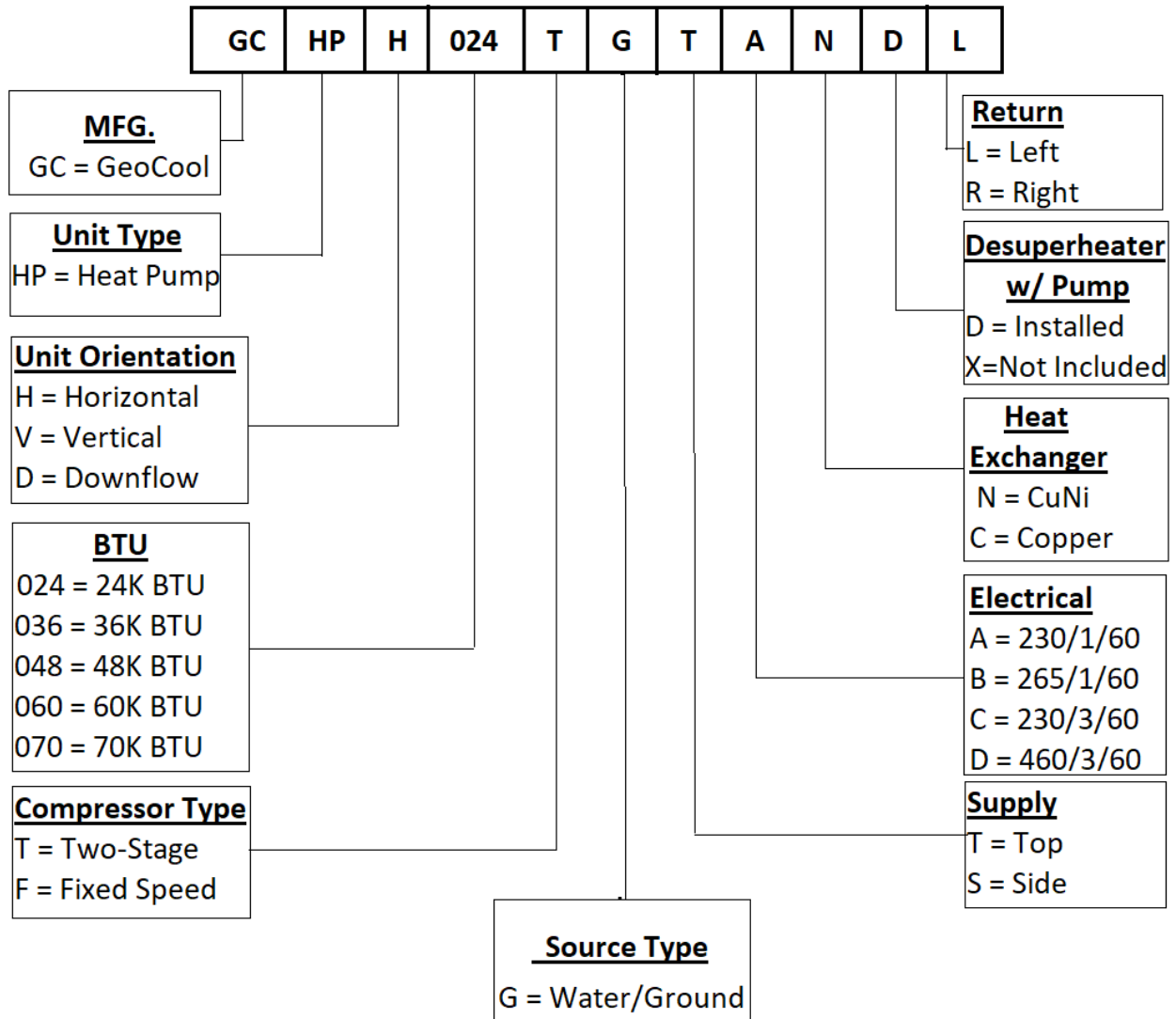

1.0 Technical Data



Two-Stage Geothermal Heat Pump Series

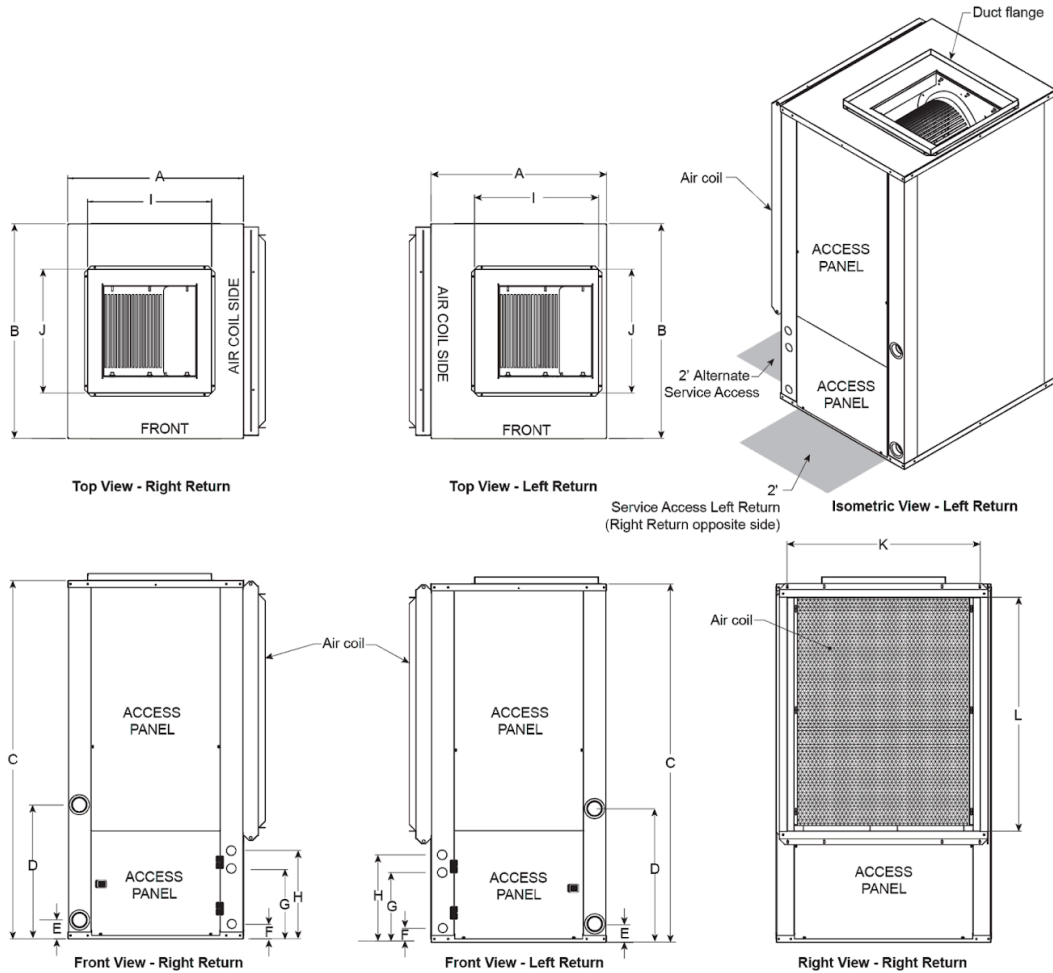

Vertical Models	Overall Cabinet			Water Connections					Discharge Connection (duct flange installed)		Return Connection		
	A	B	C	D	E	F	G	H	I	J	K	L	
	Width	Depth	Height	Water Out	Water In	HWG In	HWG Out	Condensate	Supply Width	Supply Depth	Return Depth	Return Height	
024	in.	25.75	32.00	44.00	15.00	3.00	2.38	10.75	13.50	18.00	18.00	28.00	26.00
	cm.	65.41	81.28	111.76	38.10	7.62	6.03	27.31	34.29	45.72	45.72	71.12	66.04
036	in.	25.75	32.00	44.00	18.25	3.00	2.38	10.75	13.50	18.00	18.00	28.00	26.00
	cm.	65.41	81.28	111.76	46.36	7.62	6.03	27.31	34.29	45.72	45.72	71.12	66.04
048	in.	25.75	32.00	48.00	18.25	3.00	2.38	10.75	13.50	18.00	18.00	28.00	30.00
	cm.	65.41	81.28	121.92	46.36	7.62	6.03	27.31	34.29	45.72	45.72	71.12	76.20
060	in.	25.75	32.00	52.00	19.50	3.00	2.38	10.75	13.50	18.00	18.00	28.00	34.00
	cm.	65.41	81.28	132.08	49.53	7.62	6.03	27.31	34.29	45.72	45.72	71.12	86.36

1.0 Technical Data (cont.)

Model	Capacity Modulation	Flow Rate		Ground Water Heat Pump				Ground Loop Heat Pump			
				Cooling EWT 59F		Heating EWT 50F		Cooling Brine Full Load 77F Part Load 68F		Heating Brine Full Load 32F Part Load 41F	
		GPM	CFM	Capacity Btu/h	EER Btuh/W	Capacity Btu/h	COP	Capacity Btu/h	EER Btuh/W	Capacity Btu/h	COP
024	Full	8.0	800	28,595	27.4 - 28.8	25,712	4.9 - 5.2	27,607	21.3 - 22.4	19,834	4.1 - 4.3
	Part	7.0	700	21,734	31.1 - 32.7	19,360	5.1 - 5.3	21,900	27.6 - 29.1	16,910	4.5 - 4.7
036	Full	9.0	1200	42,718	27.2 - 28.7	38,387	4.9 - 5.2	40,006	20.6 - 21.7	29,576	4.2 - 4.4
	Part	8.0	1016	31,824	33.5 - 35.3	27,450	5.1 - 5.4	30,644	27.6 - 29.1	23,976	4.6 - 4.8
048	Full	12.0	1600	57,149	27.2 - 28.6	50,275	4.8 - 5.0	53,116	20.0 - 21.1	39,389	4.1 - 4.4
	Part	11.0	1188	41,829	33.2 - 35.0	35,687	4.8 - 5.0	40,123	26.6 - 28.0	31,324	4.3 - 4.5
060	Full	15.0	1750	71,902	24.5 - 25.8	63,048	4.7 - 4.97	67,320	19.4 - 20.4	49,592	4.0 - 4.19
	Part	14.0	1484	53,918	31.2 - 32.8	45,709	5.0 - 5.29	52,278	26.1 - 27.5	40,119	4.5 - 4.69

<u>Model</u>	<u>Compressor (Amps)</u>	<u>Blower Motor (Amps)</u>	<u>Desuperheater Pump (Amps)</u>	<u>RLA</u>	<u>MCA</u>	<u>MOCP</u>
2 Ton	12.1	6.8	N/A	18.9	21.9	34.0
3 Ton	15.7	6.8	N/A	22.5	26.4	42.1
4 Ton	22.7	6.8	N/A	29.5	35.2	57.9
5 Ton	25.4	6.8	N/A	32.2	38.6	64.0
2 Ton with Desuperheater	12.1	6.8	0.15	19.1	22.1	34.2
3 Ton with Desuperheater	15.7	6.8	0.15	22.7	26.6	42.3
4 Ton with Desuperheater	22.7	6.8	0.15	29.7	35.3	58.0
5 Ton with Desuperheater	25.4	6.8	0.15	32.4	38.7	64.1

2.0 Transportation & Storage

Move and store units in an upright position. Do not stack units. Inspect shipment for shipping damage and check packing slips for accuracy. Any equipment or cartons in question should be removed from the packing and physically inspected. If any damage is detected, the carrier should make a note on the delivery slip acknowledging the damage. In some cases smaller items like thermostat or temperature sensors will be packed and shipped inside the unit.

During freezing conditions special consideration should be made to prevent unit damage. If a unit is taken to the job site or put in storage, antifreeze will need to be pumped into the water coils to prevent freezing. Failure to do this will void the warranty.

3.0 Electrical Hazard Warnings

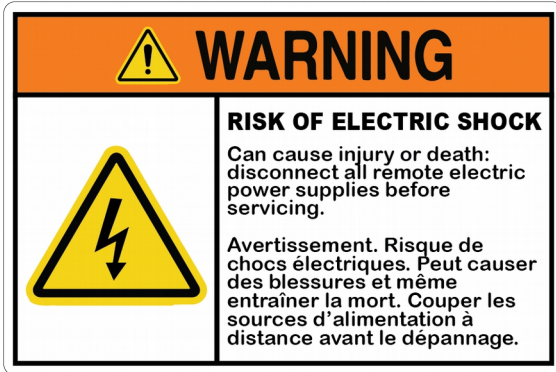

THE FOLLOWING IS A GENERAL WARNING STATEMENT WHICH SHOULD BE READ AND UNDERSTOOD BEFORE INSTALLING AND OR OPERATING YOUR NEW GEOCOOL™ UNIT

ELECTRIC SHOCK CAN KILL!!

- *Always protect yourself and others.
- *Always turn off system power before removing panels. **Some units may have more than one or two power supplies.**
- *Keep all covers and panels in place at all times. When removed for install or service purposes never leave the cover off when left unattended.
- *Do not stick hands into return, supply, or any other opening.
- *All repairs, electrical or mechanical, should be attempted only by trained technicians. In the event of a unit problem, do not reset the equipment before correcting the problem. **Equipment failure due to resetting without first correcting the problem will not be covered by the warranty.**
- *The presence of water around the base of the unit constitutes an electrical hazard. Turn off the power to the unit as soon as water leakage is discovered and call a service technician immediately.
- *All breakers/fuses supplying power to this equipment should be clearly labeled at time of installation.
- *All wiring and plumbing should be done in strict accordance with local and national codes and ordinances

4.0 Geocool System Installation

Locate the unit in an indoor area that allows for easy servicing (see image below). Make sure that the air filter access and unit access panels are easily accessible. Provide sufficient room to make all ground loop, well water, DHW, condensate, and electrical connections. If the unit is placed in a closet, make provision for adequate service access and proper return air flow to the unit. Some installations may require a condensate pump to take the condensate to a suitable drain location. Do not locate the unit in an area that is subject to freezing.

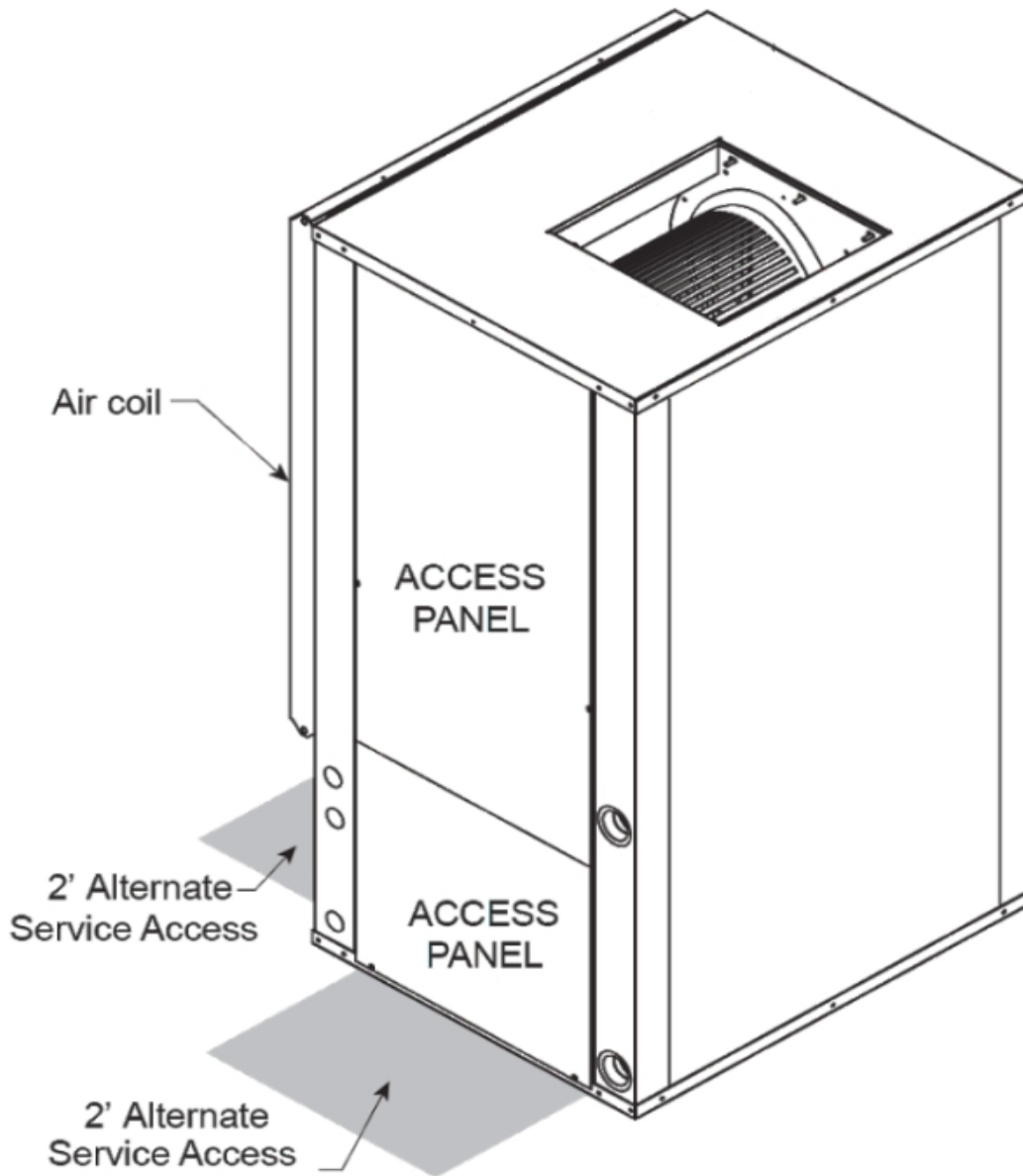

5.0 Ductwork Considerations

Important Note: If ductwork is installed in an attic area, the ductwork needs to be built “low

profile” and laid directly on the ceiling joist (code permitting). After being installed and wrapped in insulation, it is recommended the ductwork be covered with six to eight inches of **cellulose**. If the attic ductwork is not covered with **cellulose** it can lose a significant amount of its heating and cooling capacity into the attic area!! Ductwork that is inadequately insulated will cause poor system performance and customer dissatisfaction.

In the USA, ductwork sizing methods should follow ACCA “Manual D” recommendations. Install ductwork within the conditioned space of the building to minimize duct heat loss or gain, wherever possible.

To minimize air velocity noise transferring to the air supply grills, flex duct should be installed from the supply grill back six feet.

Ductwork should be designed to handle the CFM delivery for the unit while running in High Speed. Supply duct should be based on .08 inches of pressure drop per 100 feet. Return duct should be based on .05 inches of pressure drop per 100 feet.

Note: Always check register CFM requirements against register manufacturer’s data for register performance. It is extremely important to ensure that duct system return air is NOT undersized. Undersized return air can cause poor system performance and in some cases can cause the blower to “pulse”. Further, it is also important to provide adequate sized supply air plenums and ductwork. Make all turns as smooth as possible avoiding any restrictions. For residential design the target static pressure should not be greater than 0.3”.

Caution: Observe the location where your ductwork is being attached to the unit. Ensure that drilling and screws do not penetrate and damage the air coil.

5.1 Geocool System Noise and Vibration Isolation

A quality installation should be one where noise is not a complaint. A number of inexpensive features can be added to reduce noise and also aid in installation and maintenance. Flexible hose kits to the hot water loop will make for an easy connection to the heat pump and the hot water tank and also reduce any noise being transmitted from the heat pump to the indoor plumbing. Next the heat pump and all associated water pumps should be installed on a shock-absorbing pad to isolate the heat pump from a hard surface floor. This pad will help stop the possibility of the cabinet being rusted out by trapped moisture under the unit. Flexible duct connections help to eliminate noise from the heat pump being transmitted through the metal ductwork. This collar also makes the connection of the heat pump to the ductwork a much simpler task.

5.2 Air Filtering

To maintain good indoor air quality in a tight building, the air distribution system should have a high-efficiency air filter. To ensure proper unit operation, be sure to inform the building owner of

the importance of proper maintenance and the maintenance schedule for checking/changing the filter installed. Most air filters require monthly attention.

5.3 Construction / Remodeling

The Geocool unit should **NEVER** be run during any kind of construction or remodeling that would allow drywall, hard wood, or any kind of dust to be pulled in the system. Even with extra filtering dust particles can accumulate in the duct system causing unwanted dust for years to come. It can also cause air coil clogging, condensate drain clogging, blower dust accumulation and many other problems to the system. Running the system during construction / remodeling will **VOID** the system warranty

6.0 The Ground Loop System

6.1 Closed Loop Systems Plumbing

IMPORTANT! Do **NOT** use PVC or CPVC piping on any connections to your Geocool unit. The only exception where PVC or CPVC piping may be used is on the condensate lines.

Closed loop systems will require a **minimum** of 3 G.P.M. per ton if the ground loop is designed to maintain a loop temperature above 32°F and below 90°F. If design temperatures are outside of these temperatures more flow will be needed.

On residential units, a pump is typically required for each unit. The loop pump requirement will depend upon the loop design for a given application. The ground loop piping system must provide suitable access for purging the outside loop and require isolation valves for purging the inside plumbing including the unit. To properly purge a closed loop system, a minimum velocity of 2 feet per second in every branch of the ground loop must be achieved. The purge ports can also be used for anti-freeze charging.

IMPORTANT NOTICE: UNITS THAT UTILIZE GROUND LOOPS MUST MAINTAIN A MINIMUM OF 20% METHANOL OR 25% PROPYLENE GLYCOL AS ANTIFREEZE SOLUTION IN THE UNIT AND GROUND LOOP AT ALL TIMES. FAILURE TO DO SO WILL FREEZE THE SYSTEM AND CAUSE SEVERE DAMAGE TO THE UNIT. DAMAGE TO THE UNIT CAUSED BY THE FAILURE TO MAINTAIN PROPER ANTIFREEZE LEVELS IS NOT COVERED UNDER THE WARRANTY.

6.2 Purging the Closed Loop

Purging of the closed loop and unit should only be done after it has passed the air pressure check and all leaks have been repaired. Purging requires a high velocity pump and should only be done by the installing dealer or sub-contractor. See drawing below for piping example.

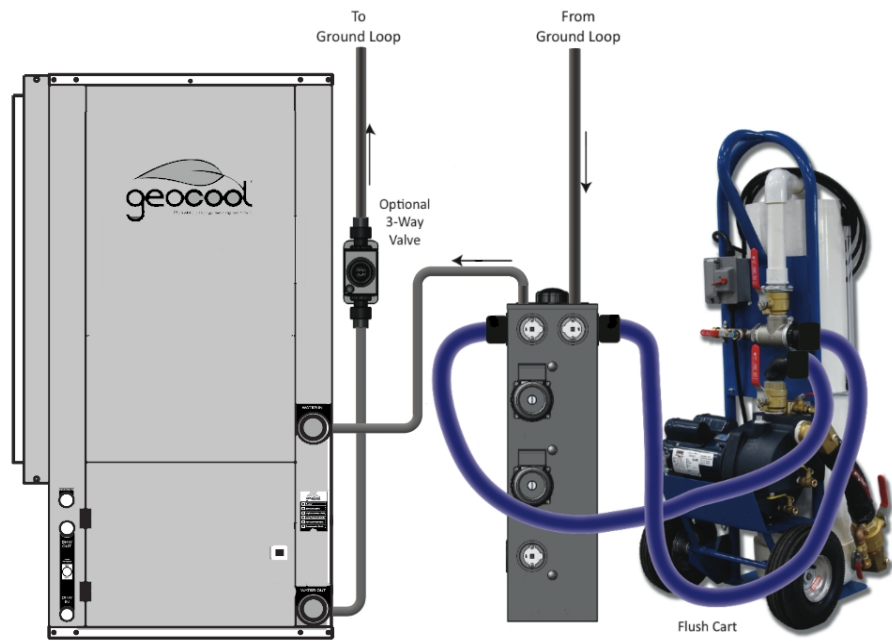

7.0 Open Loop Systems

7.1 Water Quality

Geocool units use a cupro nickel heat exchanger which has an increased resistance to ground

water chemicals which can cause build up and corrosion. The water source must be tested and treated before the installation of the Geocool unit. Failure to do so will void the warranty of the unit.

Geocool Water Quality Recommendations		
PROBLEM	CHARACTERISTIC	ACCEPTABLE VALUE
Scaling	Ryznar Stability Index	6.0 - 7.5
	Langelier Saturation Index	-0.5 - +0.5
pH Level	pH	7 - 9
Iron Fouling	Iron	< 0.2 ppm
	Iron Oxide	< 1 ppm
Erosion	Suspended Solids	< 10 ppm
Corrosion	Ammonia	< 2 ppm
	Ammonia Chloride	< 0.5 ppm
	Ammonia Hydroxide	< 0.5 ppm
	Ammonia Nitrate	< 0.5 ppm
	Ammonia Sulfate	< 0.5 ppm
	Disolved Solids	< 1500 ppm
	Carbon Dioxide	< 50 ppm
	Chlorides	< 150 ppm
	Chlorine	< 0.5 ppm
	Hydrogen Sulfide	10 - 50 ppm
	Sulfates	< 125 ppm

Always maintain water pressure in the heat exchanger by placing the water control valve at the outlet of the unit to prevent deposit buildup. Use a closed, bladder-type expansion tank to minimize mineral formation due to air exposure. Insure proper water flow through the unit. 2-3 gpm of flow **per ton** is recommended in open loop applications. Due to only minor differences in flow rate, only one motorized valve should be used on 2 speed units. The valve should be sized for high speed flow.

IMPORTANT:

On installations where the groundwater temperature is expected to fall below 50°F during any part of the heating season, perform a calculation to anticipate higher flow rate requirements. A higher water flow rate results in a lower temperature drop through the liquid to refrigerant heat exchanger. This prevents the Freeze protection/low limit from activating unnecessarily.

7.2 Discharge Water Line

Discharge water from the unit is not contaminated in any manner and can be disposed of in various ways. Discharge water should run outside with no restrictions to a discharge well, creek, pond, storm drain, etc. Discharge piping must be prepared in a manner that will not freeze. Most local codes forbid the use of sanitary sewer for disposal. Consult your local building and zoning departments to assure compliance in your area prior to discharging water.

7.3 Coil Flushing Ports

It is recommended when installing your Geocool unit to have a “Tee” on the discharge water line and the incoming water line from the well with a boiler type drain/hose bib on it between the unit and the main isolation ball valves. This will allow for flushing of the coil in certain areas where buildup or scaling can occur. See image below for an example.

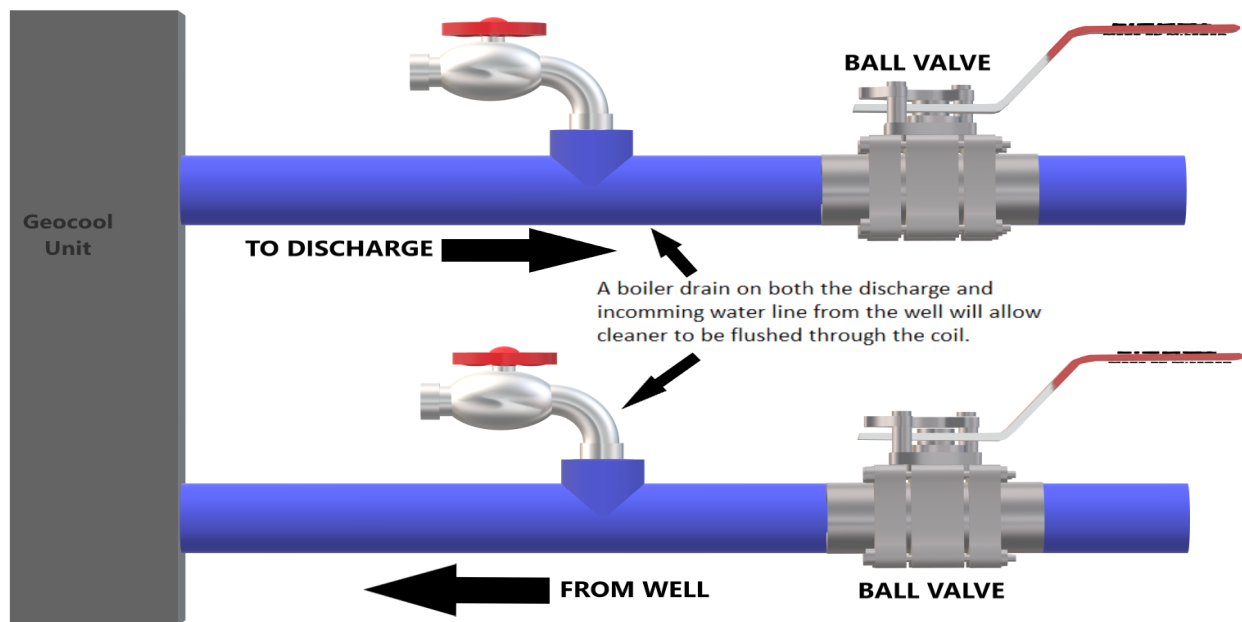

7.4 Freeze Protection

The Freeze stat helps protect the liquid to refrigerant heat exchanger from freezing internally. Freeze protection is accomplished by measuring the refrigerant temperature exiting the water coil in the heating mode. If this temperature drops below the freeze set point temperature, the unit will then lock out until manually reset.

On closed loop systems **WITH ADEQUATE ANTIFREEZE**, the tab labeled “ANTIFREEZE” should be broken off, lowering the unit freeze setpoint to 20 degrees. Use a small pair of needle nose pliers to break the tab (see image below).

On open loop systems, the tab **MUST remain in place, giving the unit a 38 degree freeze setpoint.**

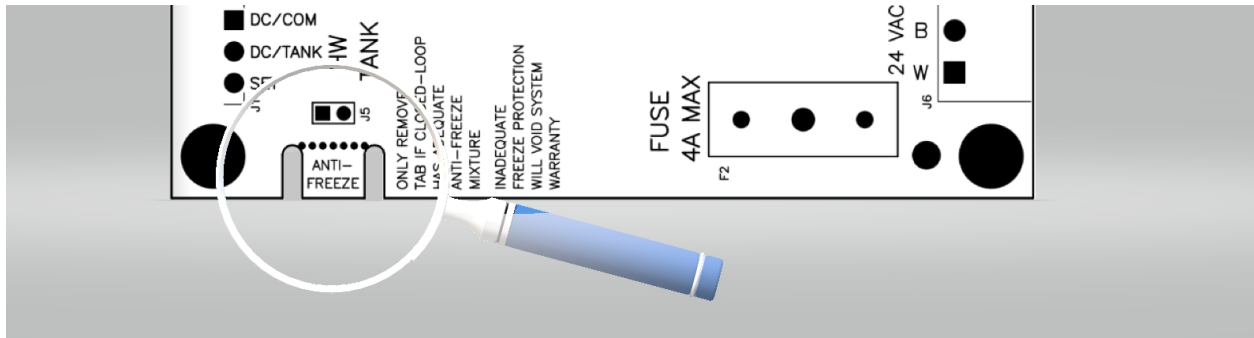

IMPORTANT!!! Once the tab has been removed, the unit will permanently be set to 20 degrees and cannot be reversed!! Removal of the tab on open loop systems or closed loop systems without minimal freeze protection will VOID all warranty on the unit!

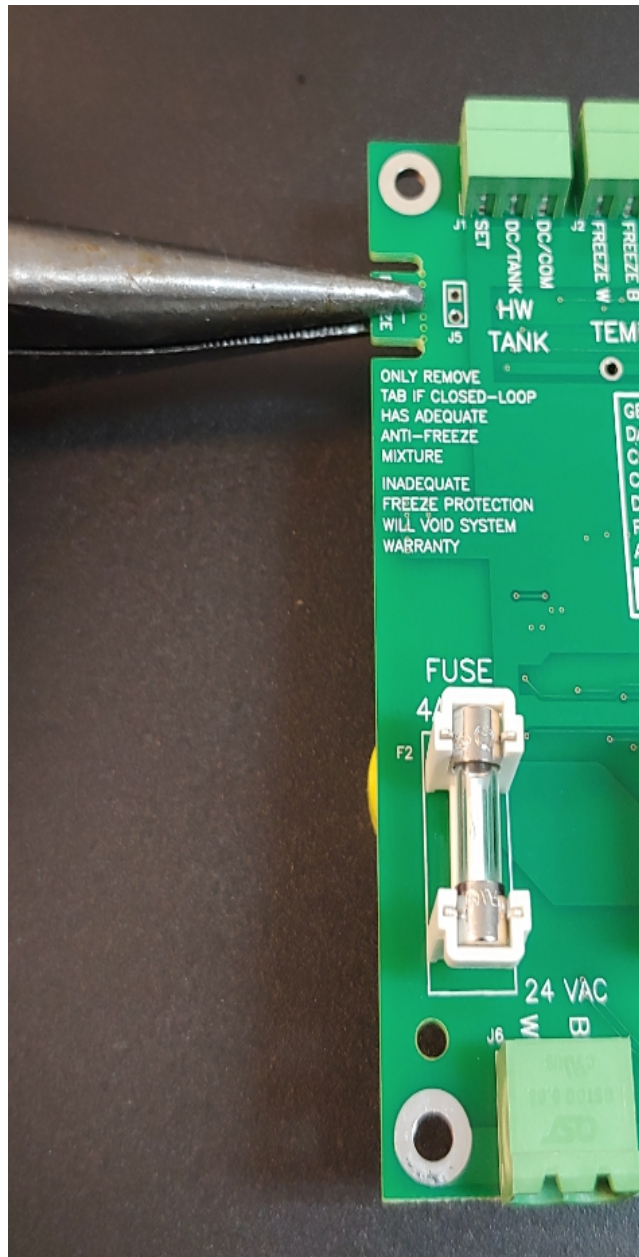

8.0 Condensate Considerations

Make provision for a condensate drain connection. Some installations require a condensate pump to take the condensate to a suitable drain. It's common practice to install extra tees near the Geocool unit to allow access for pouring drain cleaner down the condensate drain. Insure all extra openings are capped off or are plugged.

All Geocool **vertical** units have P-traps built **internally** in the units (see image below). These units require a vent to be installed downstream and outside of the unit. **Installation of a second P-Trap is not necessary and if installed, will not allow the unit's condensate pan to drain properly,**

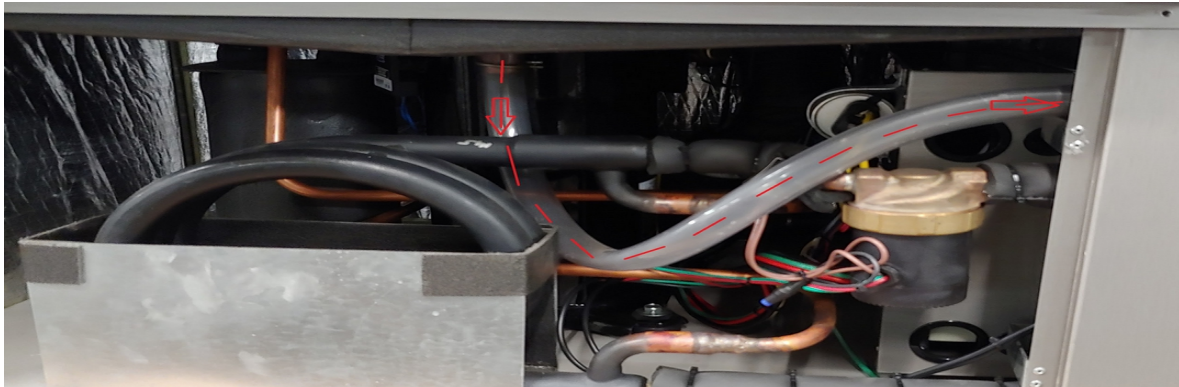

All Geocool Horizontal units are low profile. Due to this, they require **standard** P-Traps which are vented on the leaving water side and located directly **outside** the unit (see image below). Horizontal cabinets will need to be installed on a platform if not hanging in the air in order for a P-trap to be installed.

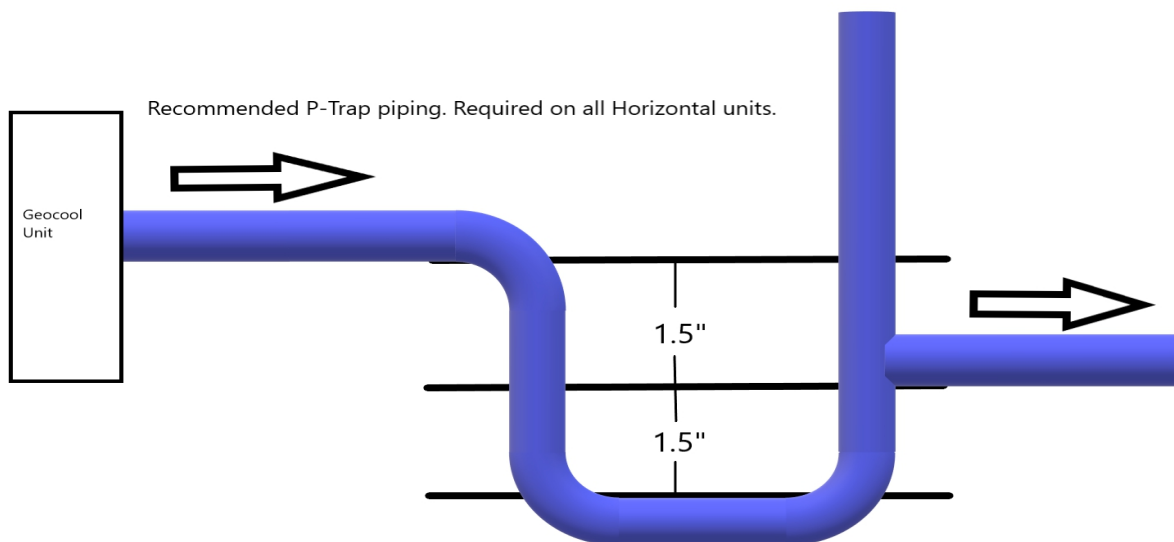

Never tie the condensate drain and the discharge water line together due to the potential

for severe water damage.

A float switch is factory installed inside the Geocool® drain pan that when triggered by condensate backing up, will shut down the compressor and a **RED** status light labeled “CONDENSATE FAULT” will show up on the front panel display. The compressor will remain off and the light illuminated until the condensate clog has been cleared.

9.0 DHW Tank Preparation

The DHW coil is a vented double-wall copper heat exchanger and is suitable for potable water. **The DHW pump is installed inside the unit and connected to a fused terminal.**

1. Turn off the power supply or the fuel supply to the DHW tank. **IF THE POWER IS NOT TURNED OFF PRIOR TO DRAINING THE TANK, THE ELECTRIC HEATING ELEMENTS WILL BURN OUT!!**
2. Close the cold water supply valve to the DHW tank.
3. Attach water hose to the tank drain connection at the bottom of the tank and empty the tank to a drain or outside location.
4. Open the pressure relief valve or faucet nearby to break the vacuum inside the hot water tank to speed up the draining process.
5. After the tank has been drained disconnect the hose and remove the DHW tank drain fitting.

9.1 Desuperheater Option Installation

Install the desuperheater circuit similar as shown in Fig. 5.2. Include isolation valves and two boiler drain valves for tank draining and DHW system purging. The valves shown in the drawing below allow for pump service without draining the DHW tank. A horizontal swing check valve must be used to prevent water in the tank from flowing backwards when the pump is not running. Use 3/4" copper pipe for lower DHW pressure drop. Remove existing drain port from the hot water tank and insert a standard dielectric fitting (thread the male end of the fitting into the water heater drain port using a P. T. F. E. based thread sealer) and continue with the installation as shown. Insulate all desuperheater circuit piping with pipe insulation.

Figure 5.2

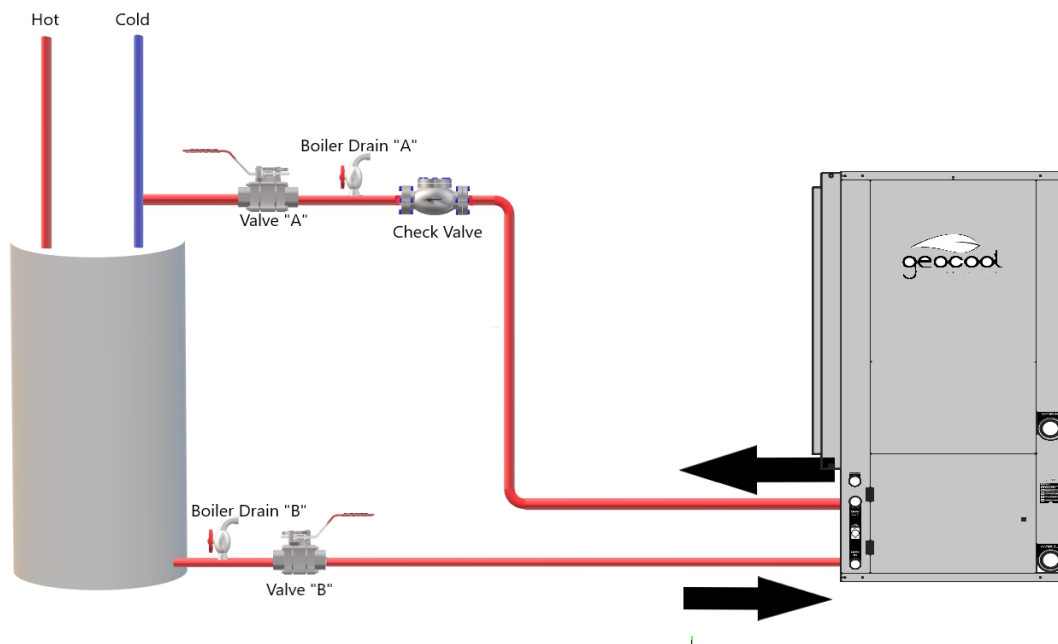

9.2. Filling the Hot Water Tank

Close boiler drain valves and the isolation valves to the Geocool system. Open the cold water supply feeding the DHW tank. Open a hot water tap in the building and allow air to bleed out of the tank. Alternatively you can depress lever on the tank relief valve to remove air trapped in the tank. Once the building plumbing is purged it is important to purge the air that is remaining in the Geocool system and plumbing between the hot water tank and the Geocool system. **Purging the building plumbing even with the isolation valves open to the DHW lines will not purge the air from the Geocool system.**

9.2.1 Purging the air and debris from the DHW circuit

ALL air must be purged from the DHW lines before the unit can be run to make hot water. Improper purging will result in air in the pump causing the pump to cavitate and damage the pump. Units are shipped from the factory with biodegradable RV antifreeze pumped into the DHW coil. If proper purging methods are followed this antifreeze will easily be purged from the system.

9.2.2 Purging the Geocool Hot Water Lines

Attach a hose to the boiler drain A (refer to figure 5.2) and run the hose to a floor drain or outside. Close the isolation valve A at the cold-water inlet on the DHW tank. Open the isolation valve B at the bottom of the tank and allow the water to flow out the hose. Allow the water to run for a few minutes while checking for air leaving the drain hose. Once all of the air has been purged, close isolation valve B and open the isolation valve A. Allow the water to flow through the system and out the hose. Run for approximately 5 to 10 minutes while checking for air leaving the drain hose. To insure no air is trapped anywhere, open both valve A and valve B to allow flow both ways. Allow water to run for approximately one minute. Once purging is complete, close the boiler drain valve and remove the drain hose and ensure that both isolation valves "A & B" are open.

10.0 Low & High voltage Connections

☐ Always use caution when working with or around electrical wiring or connections!☐

When running high and low voltage wire into the electrical box always leave enough slack to swing out or remove the electrical box. The electrical box can be swung outward by removing one screw from the unhinged side of the box. Then if desired the box can be lifted to provide easy access behind box. This only works if slack is left in the field wiring. **ALWAYS TURN OFF THE POWER TO THE UNIT BEFORE DOING THIS!!!**

The electrical box cover has a small tab that when rotated 90 degrees to a vertical position will allow the cover to swing downward on a hinge.

10.1 Main system Power

Size all wire in accordance to local electrical code. Main power will land on top of the contactor, labeled “L1 and L2”. A green ground lug will also be provided for the ground wire.

10.2 Pump outputs

A terminal strip will be provided for each pump or water valve output that applies. Each will be labeled as needed.

10.2.1 Motorized water valve (Open loop)

A 24 Vac terminal strip labeled “WATER VALVE” will be provided inside the control panel. This is a 3 wire connection including common, power open and power close. 2 wires valves can also be utilized.

10.2.2 Loop Pump (closed loop systems)

A 230V fused terminal strip labeled “CLOSED LOOP PUMP” is provided inside the control panel for the field installed ground loop pump. When the fuse is tripped, an **ORANGE** LED will light up on the terminal.

10.3 Thermostat Wiring

The thermostat will wire directly to the removable terminal block on the Dallas Board and is labeled using common thermostat lettering. (See image below for sample thermostat wiring. **Consult thermostat manual for installation instructions**).

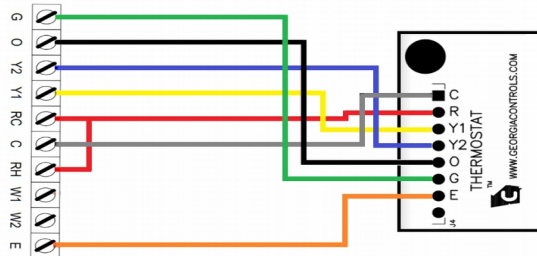

11.0 Dallas™ Microprocessor

The Dallas™ microprocessor combines simplicity with advanced controls to give the end user a range of options that can meet most install situations. With the LED indicator board, unit status can be easily checked by a technician and homeowner alike.

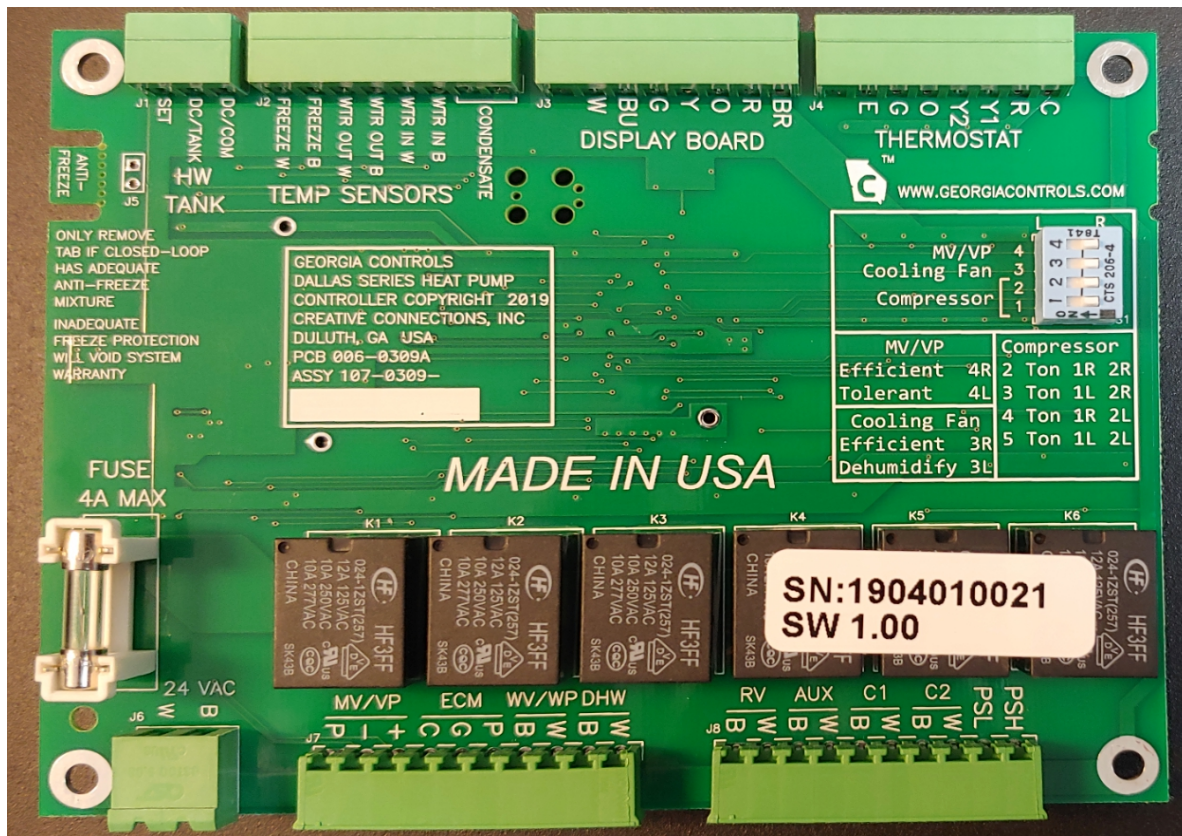

11.1 System Safeties

The Dallas board has multiple built-in safety inputs that allows multiple levels of protection on the Geocool unit.

11.1.1 Dip-Switch Settings

The Dallas board has a set of 4 dip-switches that allow a range of features included in the board to be accessed. **These should only be field adjusted by a trained factory technician.** The first 2 switches are factory set, depending on what tonnage the unit is. These match pre-set blower CFM's with the appropriate compressor size. Switch #3 allows the installer to select a slower CFM range in the cooling mode that will slow the fan down providing more dehumidification. The 4th switch is for future use and will allow the board to incorporate a variable speed flow center or a modulating electronic water valve.

11.1.2 Limit Switches

The Dallas board has independent inputs for low limit and high limit switches.

The auto-reset **high** limit switch is designed to trip at 550 psi and will shut the compressor down for 5 minutes after the switch resets. A **RED** light will blink on the LED board labeled “*HIGH PRESSURE LIMIT*” while the limit is tripped and will turn solid **RED** when the switch has reset. If the switch trips 3 times in any 30 minute period, the board will lock the compressor out. When this occurs, a **RED** light will blink, indicating the unit is in lockout status. Power must be cycled to reset the lockout but **SHOULD ONLY BE DONE AFTER THE CAUSE OF THE TRIP HAS BEEN DETERMINED AND CORRECTED!! FAILURE TO DO THIS CAN DAMAGE THE UNIT AND VOID THE WARRANTY!!**

The auto-reset **low** limit switch is designed to trip at 75 psi and will shut the compressor down for 5 minutes after the switch resets. A **RED** light labeled “*LOW PRESSURE LIMIT*” will blink on the LED board indicating the switch has been tripped and will turn solid **RED** when the switch has reset. If the switch trips 3 times in any 30 minute period, the board will lock the compressor out. Power must be cycled to reset the lockout but **SHOULD ONLY BE DONE AFTER THE CAUSE OF THE TRIP HAS BEEN DETERMINED AND CORRECTED!! FAILURE TO DO THIS CAN DAMAGE THE UNIT AND VOID THE WARRANTY!!**

11.1.3 Freeze Protection (lack of water flow)

The Freeze stat helps protect the liquid to refrigerant heat exchanger from freezing internally. Freeze protection is accomplished by measuring the refrigerant temperature exiting the water coil in the heating mode. If this temperature drops below the freeze set point, a **RED** light labeled “*FREEZE PROTECTION*” will illuminate and the unit will lock out until manually reset. **RESETTING SHOULD ONLY BE DONE AFTER THE CAUSE OF THE TRIP HAS BEEN DETERMINED AND CORRECTED!! FAILURE TO DO THIS CAN DAMAGE THE UNIT AND VOID THE WARRANTY!!**

On closed loop units **WITH ADEQUATE ANTIFREEZE**, the tab labeled “*ANTIFREEZE*” will be broken off, lowering the system freeze setpoint to 20 degrees. Use a small pair of needle nose pliers to break the tab (see image on page 13 for location).

***IMPORTANT!!! Once the tab has been broken, the system will always be set to 20 degree protection and can not be reversed!! Removal of the tab on open loop systems or closed loop systems without minimal freeze protection will VOID all warranty on system!!**

On open loop units, the tab **MUST** remain in place, giving the system a 38 degree freeze setpoint.

11.1.4 Condensate overflow switch

The unit is equipped with a normally closed (N/C) float switch, factory installed in the unit's internal drain pan. If the condensate line clogs, the float switch will be activated, shutting the compressor down and a **RED** light labeled "CONDENSATE FAULT" will be illuminated on the LED board. As soon as the pan drains, the light will go off and the compressor will be allowed to come back on.

11.2 DHW Option

On equipped units, the DHW pump will **not** be energized until the unit's compressor has been operational for 5 minutes. The pump will shut off anytime the tank reaches 135 °F.

11.3 Water Flow Control

The Dallas board is equipped to control either a loop pump/flow center for closed loop applications or a 24Vac water valve for open loop applications. A 230Vac fused terminal strip is provided for loop pumps and a 24Vac 3 position terminal strip is provided for water valves (common, N/O, & N/C).

11.4 Thermostat selection

The Dallas board is set up to accept any 24Vac "relay" type heat pump thermostat (up to 3 heat / 2 cool, depending on options) which will be wired directly to the removable, labeled Dallas board plug. (See image below)



11.5 LED indicator

On the front post of the Geocool unit, there is an LED indicator which relays unit information to the homeowner or technician. The board has a **BLUE** light for unit power, a **GREEN** light to

indicate the compressor is running, and 4 different **RED** lights to show fault status of High Pressure Limit Switch, Low Pressure Limit Switch, Freeze Protection, and Condensate Fault.





DECSTAR®

HIGH EFFICIENCY BLOWERS

12.0 Dec-Star ECM Blower

Variable Speed Blower: Geocool redefines comfort and efficiency by incorporating the new Dec-Star EMM Blower Motor Technology in our equipment. The variable speed blower coupled with the Dallas microprocessor provide: even temperatures throughout the space, better indoor air quality, precise humidity control, quieter operation and lower utility bills.

12.1 Features and Benefits of the Dec-Star

- High Efficiency Blower (HEB) housing with impeller driven by Axial Flux BLAC motor with full featured Sinusoidal EON motor control technology
- Operating speed range of 250-2400 rpm
- 4 pin Serial, and 16 pin Thermostat and PWM input to control
- Variable speed, constant torque/constant airflow ECM
- UL & cUL recognized system
- Saves 15% - 35% watts as compared to standard technology blowers with **traditional** ECM's
 - Meet next regulations including FER/SEER level
- Unique blower system removes motor from blower inlet eliminating restriction and improving system efficiencies
- Patented HEB design gives blower housing ultimate CFM for input watts
- Balanced input from both inlets providing a Uniform airflow output, unlike traditional system with motor restricting one side of blower
- Improves Heat Transfer and reduces hot spots
- Reduces pressure drop across unit
- Motor system has a shaft-less rotor system that allows the impeller to be hub-less
- Standard Triangle motor mounts with welded on brackets support the motor
- Heavy duty welded aluminized steel is standard on blower assembly

13.0 Recommended Geocool Start-Up Procedure

13.1 Startup Checklist

Verify the following items are addressed before starting the unit:

- If closed loop system, loop and unit are purged of air and all valves are open.
- Ensure a minimum of 20% methanol or 25% Propylene glycol is purged into the loop and properly mixed.
- Ensure all piping is verified to provide designed flow rate and all valves are open.
- If open loop system, well has pressure (25 PSI – 50 PSI) and all valves are open.
- All air is purged from hot water loop lines and all valves are open.
- All supply grills are installed and unrestricted.
- Return duct and grills are installed and unrestricted with filter installed.
- All service panels to air chamber are closed and secured.
- Supply voltage is correct and matches nameplate.
- Fuses, breakers, and wire sizes are correct.
- Low voltage wiring complete including all thermostats.
- Unit is level for proper condensate drainage
- Service / Access panels are in place with proper clearance to allow service to front and sides of unit.

13.2 Start Unit

- Reinstall all panels.
- Turn on the main power.
- Adjust thermostat up or down to bring system on. You may experience a time delay up to 5 minutes.
- Check to ensure blower is running.
- Check to ensure compressor is running.
- Check for proper water flow.
- Check hot water loop for water circulation if applicable.
- Set thermostat to desired temperature.
- If well water system, water flow should typically be 2 GPM to 3 GPM per ton.
- If closed loop system, check the temperature of the water in and out. This normally should not exceed a 10°F to 12 °F difference in temperature.

14.0 Preventative Maintenance

YOUR GEOCOOL WATER SOURCE HEAT PUMP HAS BEEN BUILT TO BE AS MAINTENANCE FREE AS POSSIBLE. THERE ARE ONLY A FEW THINGS YOU NEED TO DO TO KEEP YOUR SYSTEM RUNNING AS EFFICIENTLY AS POSSIBLE.

IT'S STRONGLY RECOMMENDED TO HAVE THE UNIT CHECKED ONCE A YEAR BY A TRAINED SERVICE PROFESSIONAL. MANY INSTALLING DEALERS OFFER PREVENTATIVE MAINTENANCE CHECKS.

WARNING! BEFORE PERFORMING SERVICE OR MAINTENANCE ON SYSTEM, TURN OFF ALL BREAKERS. ELECTRICAL SHOCK CAN CAUSE PERSONAL INJURY OR DEATH.

- Keep a clean air filter on your unit. Air filters need to be changed about once every 30 days or sooner, depending on the application. Always buy a good quality air filter. If filter is not changed on a regular basis, expensive air coil cleaning may be required during preventative maintenance checks.
- Give the unit an occasional visual check. Look for water around the base of the unit and listen for any unusual noises
- Closed loop systems

IMPORTANT NOTICE: UNITS THAT UTILIZE GROUND LOOPS MUST MAINTAIN A MINIMUM OF 20% METHANOL OR 25% PROPYLENE GLYCOL AS AN ANTIFREEZE SOLUTION IN THE UNIT AND GROUND LOOP AT ALL TIMES. FAILURE TO DO SO WILL ALLOW REFRIGERANT TEMPERATURES TO DROP, CAUSING INTERNAL FREEZING OF THE UNIT TO OCCUR, CAUSING SEVERE DAMAGE TO THE UNIT. DAMAGE TO THE UNIT CAUSED BY FAILURE TO MAINTAIN PROPER ANTIFREEZE LEVELS IS NOT COVERED UNDER WARRANTY.

- Open loop systems require well water to be pumped through the unit. In this application Geocool recommends the use of an isolation valve on the entering water line feeding water to the Geocool unit. It is recommended that in open loop systems the electronic water control valve be placed in the discharge line to prevent loss of pressure during off cycles. Be aware of all isolation valves so cleaning can be done with minimal water spillage. It's a good idea to be familiar with the location of the isolation valves in the event of a major water leak. All open loop systems have a discharge water line that discharges the water to a discharge well, creek, pond, etc. Check local state and county codes for proper discharge of water. Be aware of discharge location and check occasionally to insure proper drainage is occurring. During the winter, insure discharge is protected from freezing.
- Fan motors are permanently lubricated and do not need further lubrication. Motors and fan assemblies should be inspected on a yearly basis for wear during preventative maintenance checks.

- DHW plumbing consists of a closed recirculating loop which is purged free of air by the installing dealer. If any maintenance or hot water tank replacement is done, **insure the DHW plumbing is properly purged of air.** Consult with your installing dealer before draining the hot

water tank for proper procedures.

- During your annual preventative maintenance check, inspect the drain pans for debris to avoid condensate tubing blockage. Tubing needs to be checked at both ends to ensure blockage doesn't clog up the pipe from the inside or outside of the house if exposed. In areas where algae produce a slime in the drain pan, it may be necessary to chemically treat the problem.
- Geocool units are equipped with controllers that allow for a system lock out feature. If the system trips a protective limit switch 1 to 3 consecutive times, depending on what type of limit switch, the system will lockout. If the system locks out, power will need to be cycled to reset the lockout. **Before resetting the lockout you must always insure the problem causing the lockout has been repaired.** If unsure consult your installing dealer before resetting the lockout.
- Be aware of all breaker locations.
- Be aware of thermostat setting. In some cases, **programmable thermostats** will mistakenly be programmed to set the temperature back when not desired. Check the programming to insure the correct time of day and desired temperature is programmed or set the thermostat on **hold**. Which will stop the programming and allow a constant setting to be maintained.

ADDITIONAL REMINDERS: Chemicals, cleaners, inhibitors or other products that corrode or attack copper (such as Trisodium Phosphate) should never be placed into the water circulation loop(s) connected to the Geocool equipment or stored in the same room as the Geocool equipment. Failure to follow this requirement will **void the equipment warranty**. Protect the Geocool unit from freezing temperatures. If the system is in your attic or outside special precautions may need to be taken to ensure the unit and associated piping does not freeze. The Geocool unit should never be exposed to a dirty or dusty air environment. Dust, such as sawdust or sheet rock dust, can damage the electrical components, fan motor, and air coil on the unit. Simply place a cover (tarp, etc.) over the unit when construction or any other dust producing job is being done in the area of the Geocool unit. **Never** run the system during construction. Not only will sheetrock dust plug up and cause damage to the air coil but it will also accumulate in the duct system and slowly be blown out over many years.

- If the unit is ever moved from its original location, never lay it on its side. Never jar or drop the unit during transport. This is a sealed refrigeration system; rough handling may cause the system to develop a leak.
- Once removed, protect the system from freezing. Antifreeze may need to be flushed into the plumbing. When being reinstalled, antifreeze levels will need to be checked. • All plumbing from the Geocool system to the hot water tank may require a licensed plumber.
- Keep an accurate service record. Keep a copy of all service reports with this booklet.

15.0 Basic Troubleshooting for the Geocool unit

If an issue with your units occurs, refer to the following list for possible symptoms and corrective actions.

Water around base of unit:

1. Water leak. Find and repair leak.
2. Condensation pan not draining. Check for restriction, clean pan and blow out pipe.
3. Air coil freezing. Check for dirty air filter, dirty air coil, or restriction in ductwork.

Noisy operation

1. Defective fan motor/blower housing. Repair or replace blower.
2. Defective compressor. Replace compressor.
3. Refrigeration line vibration. Reposition and secure.
4. Foreign material in blower housing. Clean blower housing.
5. A "whistle" noise from ductwork. Repair leak in ductwork or check for undersized duct.
6. "Thumping" noise from water lines. Check well pressure and insure not set too high,

Low air flow

1. Leaks in ductwork. Repair ductwork.
2. Registers closed. Open registers.
3. Clogged filter. Replace filter.
4. Dirty air coil. Clean air coil.
5. Check blower module
6. Ductwork blockage. Check for possible loose insulation in ductwork.

Unit inoperative

1. No power to unit. Check electrical supply (fuses, breakers, etc.).
2. Defective thermostat. Check thermostat/control wiring and repair/replace batteries.
3. Tripped internal transformer breaker. Locate short causing trip and correct or replace bad transformer.

Compressor won't run

1. Thermostat not set properly. Read thermostat instructions and set correctly.
2. Low or high pressure limit locking out. Check LED indicator board for lockout, correct issue causing limit trip, then reset unit.
3. Freeze protection activating. Check water flow, correct issue and reset unit.
4. Bad run capacitor. Replace bad capacitor located behind electrical box.
5. Bad contactor. Replace contactor.
6. Bad compressor. Replace compressor.

Reversing valve won't switch

1. Thermostat not calling for cooling. Check thermostat wiring and programming. Repair/replace if necessary.
2. No voltage to solenoid. Correct voltage issue.
3. Bad solenoid coil. Replace coil.

Refrigerant pressure operating too high or locking out on high limit

1. **Unit running in cooling:**
 - 1.1. Too little water flow. Check loop pump including fuse on closed loop units or check well pressure and water temperatures for open loop units.
 - 1.2. Bad high limit switch. Replace limit switch.
 - 1.3. Unit overcharged. Adjust refrigerant charge.
2. **Unit running in heating:**
 - 2.1. Clogged air filter. Replace filter.
 - 2.2. Dirty air coil. Clean air coil.
 - 2.3. Bad high limit switch. Replace limit switch.
 - 2.4. Unit overcharged. Adjust refrigerant charge.
 - 2.5. Check blower module.

Refrigerant pressures operating too low or locking out low limit

1. **Unit running in cooling:**
 - 1.1. Refrigerant leak. Find and repair leak.
 - 1.2. Dirty air filter. Replace air filter.
 - 1.3. Dirty air coil. Clean air coil.
 - 1.4. Bad low pressure switch. Replace limit switch.
 - 1.5. Check blower module.
2. **Unit running in heating:**
 - 2.1. Refrigerant leak. Find and repair leak.
 - 2.2. Too little water flow. Check loop pump including fuse on closed loop units or check well pressure and water temperatures on open loop units.
 - 2.3. Bad low pressure switch. Replace limit switch.

Freeze sensor tripping

1. Too little water flow. Check loop pump including fuse on closed loop units or check well pressure on open loop units.
2. Bad freeze sensor. Replace sensor located on exiting refrigerant line of heat exchanger.
3. Closed loop unit **WITH** antifreeze but “*ANTIFREEZE*” tab on Dallas® board not removed. Use a small pair of needle nose pliers to remove the tab. **SEE PAGE 13, SECTION 7.4 FOR MORE INFO REGARDING FREEZE PROTECTION.**

Fan runs continuously when compressor is off

1. Thermostat set to “fan on”. Set thermostat to “fan auto”.

16.0 Wiring diagram

