



CONVOTHERM

OES OEB OGS OGB



ENG User manual

Translation of the original

Table of Contents

1	General information	5
	▶ EC Declaration of Conformity in compliance with Directive 2006/42/EC, Annex II A	6
	▶ Environmental protection	9
	▶ Identifying your combi steamer	10
	▶ About this user manual	13
2	Layout and function	15
	▶ Intended use of your combi steamer	16
	▶ Design and function of the combi steamer	18
	▶ Technical data for OES	22
	▶ Technical data for OGS	26
	▶ Technical data for OEB	29
	▶ Technical data for OGB	33
3	For your safety	36
	▶ Basic safety code	37
	▶ Warning signs on the combi steamer	38
	▶ Summary of hazards	40
	▶ Hazards and safety precautions	43
	▶ Safety devices	46
	▶ Requirements to be met by personnel, working positions	48
	▶ Personal protection equipment	49
4	Layout of the control panel	50
	▶ Layout of the control panel	51
	▶ The controls	52
	▶ The Functions menu	54
	▶ The Cookbook menu	57
	▶ The Write/Edit menu	58
5	How to operate the control panel	59
5.1	First operating steps	60
	▶ Turning the combi steamer on and off	61
	▶ Cooking with Press&Go (optional)	63
5.2	Cooking and regenerating	65
5.2.1	Basic procedures	66
	▶ Basic working procedure for cooking	67
	▶ Basic working procedure for regenerating	67
	▶ Basic working procedure in emergency mode	68
5.2.2	Entering the cooking data	69
	▶ Basic procedure for entering the cooking data	70
	▶ Entering a cooking program	71
	▶ Entering the regenerating program	72
	▶ Entering a multi-step cooking or regenerating program	73
	▶ Setting the start-time preset	75

5.2.3	Selecting extra functions and special programs	77
	▶ Basic procedure for selecting extra functions and special programs	78
	▶ Selecting Crisp&Tasty (moisture removal)	80
	▶ Selecting the preheat option	81
	▶ Setting Delta-T cooking	82
	▶ Setting Cook & Hold	83
	▶ Entering a reduced power (optional for OES)	84
	▶ Specifying a reduced fan speed (optional for OES and OGS)	85
	▶ Setting program protection (only for OEB and OES)	86
	▶ Including a beep signal in a cooking program	87
	▶ Setting overnight cooking	88
	▶ Applying the keypad lock	89
5.2.4	Performing cooking and regenerating	92
	▶ Cooking as part of the daily routine	93
	▶ Regenerating as part of the daily routine	95
	▶ Manual steaming during cooking and regenerating	97
	▶ Using Tray Timer (additional timer) during cooking and regenerating	98
5.3	Working with the cookbook	100
	▶ Retrieving a recipe from the cookbook	101
	▶ Creating a cooking recipe	102
	▶ Recording a cooking program	103
	▶ Transferring a recipe to the cookbook	105
	▶ Editing, deleting and copying recipes	106
	▶ Inserting, appending and deleting cooking steps	108
	▶ Working with Press&Go	111
5.4	Adjusting the default settings	113
	▶ Accessing the default settings	114
	▶ Setting the beep signal	115
	▶ Adjusting the volume	116
	▶ Setting the time	117
	▶ Setting the date	118
	▶ Sorting alphabetically or numerically	119
	▶ Changing the Expert default values and selecting to use last-used values	120
	▶ Select temperature display	122
	▶ Configuring the network address	123
	▶ Saving / loading the cookbook	124
	▶ Setting the language	125
6	Your combi steamer cooking programs	126
	▶ Steaming	127
	▶ Superheated steam	129
	▶ Convection	130
	▶ Regenerate	131
	▶ Core temperature control	133
	▶ Delta-T cooking	135
	▶ Cook & Hold	137
	▶ Overnight cooking	139
7	Using the cooking programs	142
	▶ Side dishes	143
	▶ Fish	144
	▶ Meat, game, poultry	145
	▶ Pastries and baked desserts	147

8	Cleaning and Maintenance	148
	▶ Cleaning and maintenance schedule	149
	▶ Semi-automatic oven cleaning	153
	▶ Fully automatic oven cleaning (CONVOClean system option)	156
	▶ Emptying and rinsing the steam generator	158
	▶ Descaling early warning (only on OEB)	159
	▶ Cleaning agents	160
	▶ Troubleshooting	161
	▶ Rectifying faults - Irregularities during operation	163
9	How to do it correctly	164
	▶ Opening the appliance door safely	165
	▶ Inserting and removing the preheat bridge (floor-standing appliances only)	167
	▶ Removing and fitting the racks (table-top appliances only)	169
	▶ Loading table-top appliances / removing food from table-top appliances	170
	▶ Loading table-top appliances using the transport trolley	172
	▶ Loading floor-standing appliances	176
	▶ Stowing away the core temperature sensor for table-top appliances	178
	▶ Stowing away the core temperature sensor for floor-standing appliances	179
	▶ Removing and fitting the suction panel on table-top appliances	180
	▶ Removing and fitting the suction panel on floor-standing appliances	182
	▶ Grill version (only for table-top appliances)	184
	▶ Cleaning the double glass door	186
	▶ Cleaning the removable hygienic plug-in gasket	188
	▶ Cleaning the bypass measuring hole	189
	▶ Cleaning the demoinsturising tray	192
	▶ Emptying the condensate collecting tray in the loading trolley	194
	▶ Cleaning the armature	196
	▶ Changing the cleaning canisters containing CONVOClean forte	197
	▶ Changing the cleaning canisters containing CONVOCare	198

1 General information

Purpose of this chapter

This chapter shows you how to identify your combi steamer and provides guidance on using this manual.

Contents

This chapter contains the following topics:

	Page
EC Declaration of Conformity in compliance with Directive 2006/42/EC, Annex II A	6
Environmental protection	9
Identifying your combi steamer	10
About this user manual	13

► EC Declaration of Conformity in compliance with Directive 2006/42/EC, Annex II A

Manufacturer

CONVOTHERM Elektrogeräte GmbH
 Talstraße 35
 82436 Eglfing
 Germany

Condition when placed on market

This declaration only applies to the machine in the condition in which it was placed on the market; it does not cover any subsequent modifications and/or parts fitted later by the end user. This declaration is invalidated if the product is converted or modified without approval.

Appliances

This Declaration of Conformity applies to the following combi steamers:

OES electric appliances	6.10	6.20	10.10	10.20	12.20	20.10	20.20
...							
OEB electric appliances	6.10	6.20	10.10	10.20	12.20	20.10	20.20
...							
OGS gas appliances ...	6.10	6.20	10.10	10.20	12.20	20.10	20.20
OGB gas appliances ...	6.10	6.20	10.10	10.20	12.20	20.10	20.20

Declaration of Conformity with directives

The manufacturer declares that its combi steamers, as listed above, comply with European Directive 2006/42/EC (Machinery Directive, Official Journal of the European Union L 157/24 dated 9.6.2006) and with the following directives.

The safety objectives of European Directive 2006/95/EC (Low Voltage Directive, Official Journal of the European Union L 374/10 dated 27.12.2006) have been met in accordance with Annex I, Section 1.5.1 of the Machinery Directive.

Compliance of electric appliances with other Directives

The electric appliances comply with the requirements in the following European directives:

2004/108/EC Official Journal of the European Union L 390/24 dated 31.12.2004	RoHS 2002/95/EC Official Journal of the European Union L 37/19 dated 13.2.2003
---	---

Compliance of gas appliances with other Directives

The gas appliances comply with the requirements in the following European directives:

2004/108/EC Official Journal of the European Union L 390/24 dated 31.12.2004	2009/142/EC Official Journal of the European Union L 330/10 dated 16.12.2009	RoHS 2002/95/EC Official Journal of the European Union L 37/19 dated 13.2.2003
---	---	---

Type examinations carried out on electrical appliances

The following type examinations have been carried out:

Notified body for **EMC testing**:

mikes-testingpartners gmbh, Ohmstr. 2-4, 94342 Strasskirchen, Germany

- Report no. E24731-00-00KA, E31744-00-00KA
- Reference no. BNetzA-bS EMV-07/61-07

Notified body for **Electrical safety**

TÜV Süd Management Service GmbH, Ridlerstr. 65, 80339 Munich, Germany

- Report no. 028-70072074-000
- Certificate registration no. Z1A 04 10 18434 017

Notified body for **Water testing**:

SVGW Schweizerischer Verein Gas- und Wasserfach, Gütlistr. 44, 8027 Zurich, Switzerland

- Report no. / Certificate no. 0408-4858

Type examinations carried out on gas appliances

The following type examinations have been carried out:

Notified body for **EMC testing**:

mikes-testingpartners gmbh, Ohmstr. 2-4, 94342 Strasskirchen, Germany

- Report no. E32636-00-00KA
- Reference no. BNetzA-bS ENV-07/61-07

Notified body for **Water testing**:

SVGW Schweizerischer Verein Gas- und Wasserfach, Gütlistr. 44, 8027 Zurich, Switzerland

- Report no. / Certificate no. 0408-4858

Notified body for **Gas testing and electrical safety**:

Kiwa Gas Technology B.V., Wilmersdorf 50, 7327 AC Apeldoorn, The Netherlands

- Report no. 0063/E1165/176324
- Reference no. 0063BP3324

Quality and environmental management

CONVOTHERM Elektrogeräte GmbH employs a certified quality management system in accordance with ISO 9001:2008 and a certified environmental management system in accordance with ISO 14001:2004.

Notified body for quality management system and environmental management system:

TÜV Süd Management Service GmbH, Ridlerstr. 65, 80339 Munich, Germany

- Report no. 70007041
- Certificate registration no. 12100/104 14754 TMS

Authorized representative

The following person is authorized to compile the technical documentation in accordance with Annex II A Section 2 of Directive 2006/42/EC

CONVOTHERM Elektrogeräte GmbH, Gisela Rosenkranz, Abteilung technische Redaktion, Talstraße 35, 82436 Eglfing, Germany

Eglfing, 29.12.2009



ppa. Lutz Riefenstein
Bereichsleiter Technik / General Manager Engineering

► Environmental protection

Statement of principles

Our customers' expectations, the legal regulations and standards and our company's own reputation set the quality and service for all our products.

We have an environmental management policy that not only ensures compliance with all environmental regulations and laws, but also commits us to continuous improvement of our green credentials.

We have developed a quality and environmental-management system in order to guarantee the continued manufacture of high-quality products, and to be sure of meeting our environmental targets.

This system satisfies the requirements of ISO 9001:2008 and ISO 14001:2004.

Environmental protection procedures

We observe the following procedures:

- Use of residue-free compostable wadding materials
- Use of RoHS-compliant products
- Multiple re-use of cardboard packaging
- Recommendation and use of bio-degradable cleaning agents
- Recycling of electronic waste
- Environmentally friendly disposal of old appliances via the manufacturer

Join us in a commitment to environmental protection.

► Identifying your combi steamer

Position and layout of the type plate

You can use the type plate to identify your combi steamer. The type plate is located on the left-hand side of the combi steamer.

The type plate has the following layout on electric appliances:

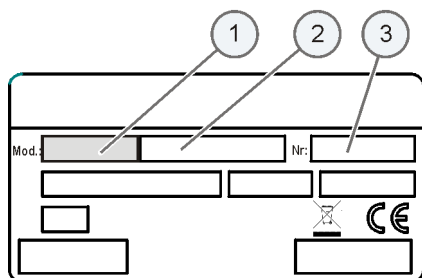

The type plate has the following layout on gas appliances:

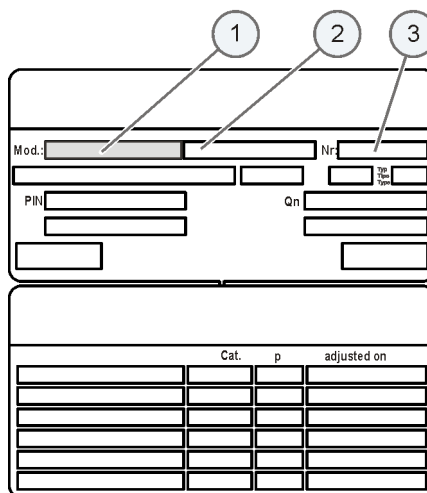

The following table lists the relevant items on the type plate:

Item number	Meaning
1	trade name
2	part number
3	serial number

Code making up the trade name

On both type plates, the code making up the trade name (1) identifies your appliance:

Elements of the trade name	Meaning
Letters	
1. letter	O = Eco (always present)
2. letter	E = Electric appliance G = Gas appliance
3. letter	B = Appliance with steam generator S = Appliance with injection
Numerical values	
xx.yy	Appliance size

Identification using the display

If a type plate is no longer legible or has disappeared, you can find the appliance data from the combi steamer display.

Table-top appliances

Use the table below to identify your table-top appliance from the trade name on the type plate:

Model	Type	Number of shelves		Optional shelves	
		1/1 GN	2/1 GN	600 x 400 baking tray	Number of plates
OES 6.10	Electric appliance with injection	7	-	5	20
OGS 6.10	Gas appliance with injection	7	-	5	20
OEB 6.10	Electric appliance with steam generator	7	-	5	20
OGB 6.10	Gas appliance with steam generator	7	-	5	20
OES 6.20	Electric appliance with injection	14	7	12	42
OGS 6.20	Gas appliance with injection	14	7	12	42
OEB 6.20	Electric appliance with steam generator	14	7	12	42
OGB 6.20	Gas appliance with steam generator	14	7	12	42
OES 10.10	Electric appliance with injection	11	-	7	32
OGS 10.10	Gas appliance with injection	11	-	7	32
OEB 10.10	Electric appliance with steam generator	11	-	7	32
OGB 10.10	Gas appliance with steam generator	11	-	7	32
OES 10.20	Electric appliance with injection	22	11	18	63
OGS 10.20	Gas appliance with injection	22	11	18	63
OEB 10.20	Electric appliance with steam generator	22	11	18	63
OGB 10.20	Gas appliance with steam generator	22	11	18	63

Floor-standing appliances

Use the table below to identify your floor-standing appliance from the trade name on the type plate:

Model	Type	Number of shelves		Optional shelves	
		1/1 GN	2/1 GN	600 x 400 baking tray	Number of plates
OES 12.20	Electric appliance with injection	24	12	10	59 or 74
OGS 12.20	Gas appliance with injection	24	12	10	59 or 74
OEB 12.20	Electric appliance with steam generator	24	12	10	59 or 74
OGB 12.20	Gas appliance with steam generator	24	12	10	59 or 74
OES 20.10	Electric appliance with injection	20	-	17	50 or 61
OGS 20.10	Gas appliance with injection	20	-	17	50 or 61
OEB 20.10	Electric appliance with steam generator	20	-	17	50 or 61
OGB 20.10	Gas appliance with steam generator	20	-	17	50 or 61

Model	Type	Number of shelves		Optional shelves	
		1/1 GN	2/1 GN	600 x 400 baking tray	Number of plates
OES 20.20	Electric appliance with injection	40	20	17	98 or 122
OGS 20.20	Gas appliance with injection	40	20	17	98 or 122
OEB 20.20	Electric appliance with steam generator	40	20	17	98 or 122
OGB 20.20	Gas appliance with steam generator	40	20	17	98 or 122

Specific operating requirements for particular types of appliance

The following table summarizes the specific operating requirements for particular types of appliance:

Model	Type	Procedure	Please observe the following points
OEB or OGB	Appliances with steam generator	daily task at switch-on	the steam generator must be emptied and rinsed daily: <i>Emptying and rinsing the steam generator on page 158</i>
Table-top appliances	all types	Loading	<ul style="list-style-type: none"> ▪ shelves in rack <i>Removing and fitting the racks (table-top appliances only) on page 169</i> <i>Loading table-top appliances / Removing food from table-top appliances on page 170</i> ▪ using the transport trolley <i>Loading table-top appliances using the transport trolley on page 172</i>
Floor-standing appliances	all types	Loading	always use loading trolley: <i>Loading floor-standing appliances on page 176</i>
Floor-standing appliances	all types	Preheating	always insert preheat bridge before preheating <i>Inserting and removing the preheat bridge (floor-standing appliances only) on page 167</i>

▶ About this user manual

Purpose

This user manual provides answers to the following questions:

- What food can I cook using the combi steamer?
- What particular cooking methods are offered by the combi steamer?
- How can I use the combi steamer to perform specific cooking methods?

The aim of this user manual is to show you how to perform the following tasks:

- Entering cooking program data
- Working with the cookbook
- Making settings
- Loading the combi steamer
- Removing food
- Cleaning the combi steamer
- Fitting accessories in the combi steamer

Who should read this manual

This user manual is aimed at the following groups:

Name of target group	Qualifications	Tasks	Chapter to read before task
Chef	<ul style="list-style-type: none"> ▪ Has relevant professional training ▪ Knows relevant national food legislation and regulations, plus hygiene legislation and regulations ▪ Must keep records in accordance with HACCP ▪ Trained in how to operate the combi steamer 	<ul style="list-style-type: none"> ▪ Entering cooking program data ▪ Editing recipes in the cookbook ▪ Managing default settings ▪ Loading the combi steamer ▪ Starting the cooking program ▪ Removing food 	<ul style="list-style-type: none"> ▪ Layout and function ▪ For your safety ▪ Layout of the control panel ▪ How to operate the control panel ▪ Your combi steamer cooking programs ▪ Using the cooking programs
User	<ul style="list-style-type: none"> ▪ Semiskilled ▪ Trained in how to operate the combi steamer 	<ul style="list-style-type: none"> ▪ Loading the combi steamer ▪ Starting the cooking program ▪ Removing food ▪ Cleaning the combi steamer ▪ Fitting accessories in the combi steamer ▪ Minor maintenance tasks 	<ul style="list-style-type: none"> ▪ Layout and function ▪ For your safety ▪ Layout of the control panel ▪ How to operate the control panel ▪ Your combi steamer cooking programs ▪ Using the cooking programs ▪ Cleaning and Maintenance ▪ How to do it correctly

Documents included in the Customer documentation

The customer documentation for the combi steamer includes the following documents:

- Installation manual
- User manual (this document)



Chapters in the user manual

The table below lists the chapters in this manual and summarizes their content, purpose and target groups:

Chapter/section	Purpose	Target group
General information	<ul style="list-style-type: none"> Shows you how to identify your combi steamer Provides guidance on using this manual 	Chef User
Layout and function	<ul style="list-style-type: none"> Specifies the intended use of the combi steamer Explains the functions of the combi steamer and shows the position of its components Summarizes the technical data 	Chef User
For your safety	<ul style="list-style-type: none"> Describes the hazards posed by the combi steamer and suitable preventive measures <p>You should read this chapter carefully in particular.</p>	Chef User
Layout of the control panel	<ul style="list-style-type: none"> Describes the user interface 	Chef User
How to operate the control panel	<ul style="list-style-type: none"> Contains instructions for basic operation of the combi steamer 	Chef User
Your combi steamer cooking programs	<ul style="list-style-type: none"> Describes the cooking programs 	Chef User
Using the cooking programs	<ul style="list-style-type: none"> Gives examples of how to use the cooking programs 	Chef User
Cleaning and Maintenance	<ul style="list-style-type: none"> Contains the cleaning schedule Contains the maintenance schedule where relevant to the user Contains cleaning instructions 	User
How to do it correctly	<ul style="list-style-type: none"> Contains instructions for regularly used operating procedures for the combi steamer 	User

Symbols used for safety instructions

Safety instructions are categorized according to the following hazard levels:

Hazard level	Consequences	Likelihood
 DANGER	Death / serious injury (irreversible)	Immediate risk
 WARNING	Death / serious injury (irreversible)	Potential risk
 CAUTION	Minor injury (reversible)	Potential risk
Caution	Damage to property	Potential risk

2 Layout and function

Purpose of this chapter

This chapter specifies the intended use of the combi steamer and explains its functions.

Contents

This chapter contains the following topics:

	Page
Intended use of your combi steamer	16
Design and function of the combi steamer	18
Technical data for OES	22
Technical data for OGS	26
Technical data for OEB	29
Technical data for OGB	33

▶ Intended use of your combi steamer

Intended use

The combi steamer must only be used for the purposes specified below:

- The combi steamer is designed and built solely for cooking different foodstuffs. Steam, convection and superheated steam are used for this purpose.
- The combi steamer is intended solely for professional, commercial use.
- The ambient temperature must lie between 4°C and 35°C.

In addition, the combi steamer is only being used as intended when the following conditions are met:

- To avoid accidents and damage to the combi steamer, the owner must train staff regularly. The combi steamer must only be operated by trained staff.
- The manufacturer regulations for operation and maintenance of the combi steamer must be observed.

Maximum permissible loading weight

The following table shows the maximum permissible loading weight per combi steamer. These values are based on the condition that each shelf can take a maximum load of 15 kg:

Maximum permissible loading weight		6.10	6.20	10.10	10.20	12.20	20.10	20.20
GN (containers, shelf-grills, baking trays)								
per combi steamer	[kg]	30	60	50	100	120	100	180
per shelf	[kg]	15	15	15	15	15	15	15
600 x 400 tray (containers, shelf-grills, baking trays)								
with packaging	[kg]	30	60	50	100	120	100	180
without packaging	[kg]	15	15	15	15	15	15	15

Restrictions on use

The following restrictions on use must be observed:

- The combi steamer must not be operated in toxic or potentially explosive atmospheres.
- The combi steamer must only be operated at ambient temperatures between +4°C and +35°C.
- The combi steamer must only be used by trained personnel.
- The combi steamer must be suitably sheltered from the rain and wind if operated outdoors.
- The combi steamer must not be loaded over the maximum permissible loading weight for the given model.
- The combi steamer must only be operated when all safety devices are fitted and in working order.
- Dry powder or granulated material must not be heated in the combi steamer.
- Highly flammable objects with a flash point below 270 °C must not be heated in the combi steamer. These include items such as highly flammable oils, fats or cloths (kitchen cloths).
- Food in sealed tins or jars must not be heated in the combi steamer.

Requirements to be met by personnel

The following requirements must be met by personnel:

- The combi steamer must only be operated by trained personnel.
- Personnel must be aware of the risks and regulations associated with handling heavy loads.

Requirements relating to the operating condition of the combi steamer

The following requirements relating to the operating condition of the combi steamer must be met:

- The combi steamer must only be operated when all safety devices are working correctly.
- The combi steamer must only be operated when all appliance covers and panels are fitted correctly.

Requirements relating to the operating environment of the combi steamer

The following requirements relating to the operating environment of the combi steamer must be met:

- The combi steamer must not be operated in the vicinity of flammable gases or liquids.
- The combi steamer must not be operated in toxic or potentially explosive atmospheres.
- The combi steamer must be sheltered from the rain if operated outdoors.
- The kitchen floor must be kept dry to reduce the risk of accidents.
- The combi steamer (gas appliance) must not be transported in a moving truck during cooking.

Cleaning requirements

The following requirements must be met during cleaning:

- Only original cleaning agents must be used.
- High-pressure cleaners or water jets must not be used for cleaning.
- The combi steamer must not be treated with acids or exposed to acid fumes.

► Design and function of the combi steamer

Table-top appliance construction

The following diagram shows a gas appliance and an electric appliance, representing all table-top appliances:

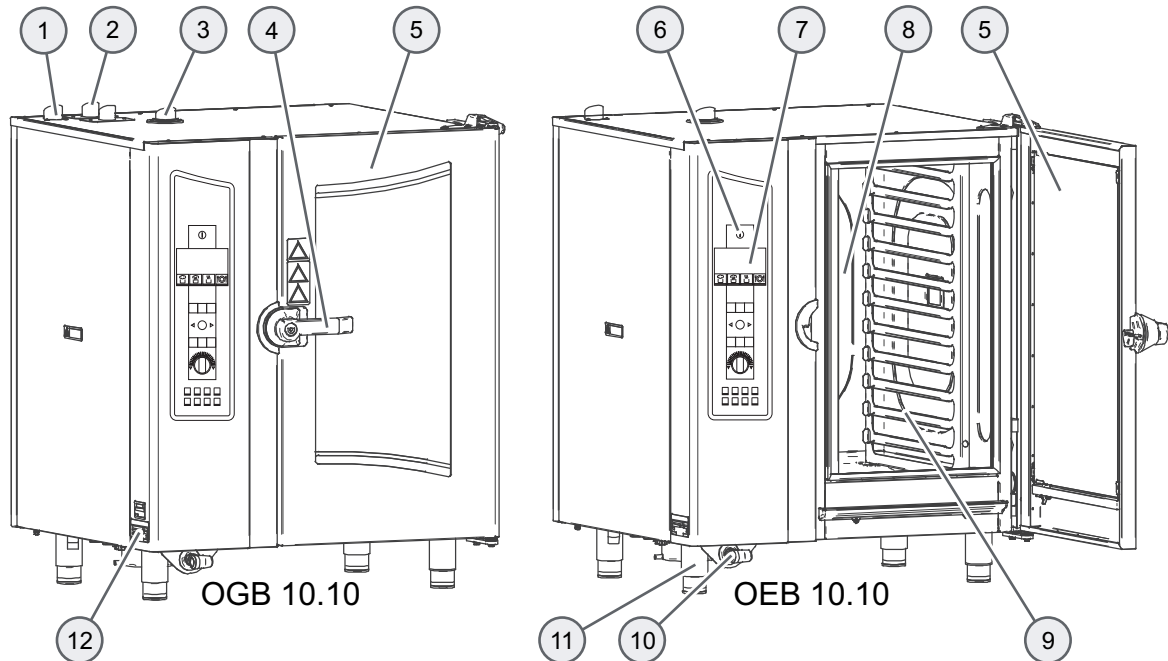

Components of the table-top appliances and their function

The components of the table-top appliances have the following function

No.	Name Picture	Function
1	Air vent	Controls ventilation
2	Gas flue pipe	On gas appliances only: <ul style="list-style-type: none"> ▪ 1 gas flue pipe on appliances with injection ▪ 2 gas flue pipes on appliances with steam generator
3	Low-pressure failsafe device	Prevents the low pressure in the oven e.g. during fully automatic cleaning (CONVOClean system)
4	Multi-function door handle ("Hygienic Handle")	Has the following functions depending on its position: <ul style="list-style-type: none"> ▪ Pointing vertically downwards: combi steamer closed, ready for cooking ▪ Horizontal: combi steamer open, in on-latch position ▪ 20 degrees above horizontal: Combi steamer can be opened Also has the following functions: <ul style="list-style-type: none"> ▪ Additional function as far as on-latch position ▪ In the on-latch position, door can be opened from inside oven in an emergency ▪ Antibacterial with silver ions
5	Appliance door ("disappearing door")	<ul style="list-style-type: none"> ▪ Seals the oven during cooking ▪ Special opening action allows it to slide back against the side of the combi steamer to save space

No.	Name Picture	Function
6		Switches the combi steamer on and off
7	Control panel	Central control of the combi steamer: <ul style="list-style-type: none"> ▪ Controls: membrane keypad and tilt selector switch ▪ Status displays
8	Oven	<ul style="list-style-type: none"> ▪ Contains the food during cooking ▪ Has a different number of shelf levels depending on model
9	Rack	Used to hold GN containers or baking trays
10	Hand shower	<ul style="list-style-type: none"> ▪ Used for rinsing out the oven with water ▪ Continuous flow adjustment
11	Appliance feet	Can be adjusted in height to allow the combi steamer to be positioned horizontally
12	Type plate	Used for identifying the combi steamer

Floor-standing appliance construction

The following diagram shows a gas appliance and an electric appliance, representing all floor-standing appliances:

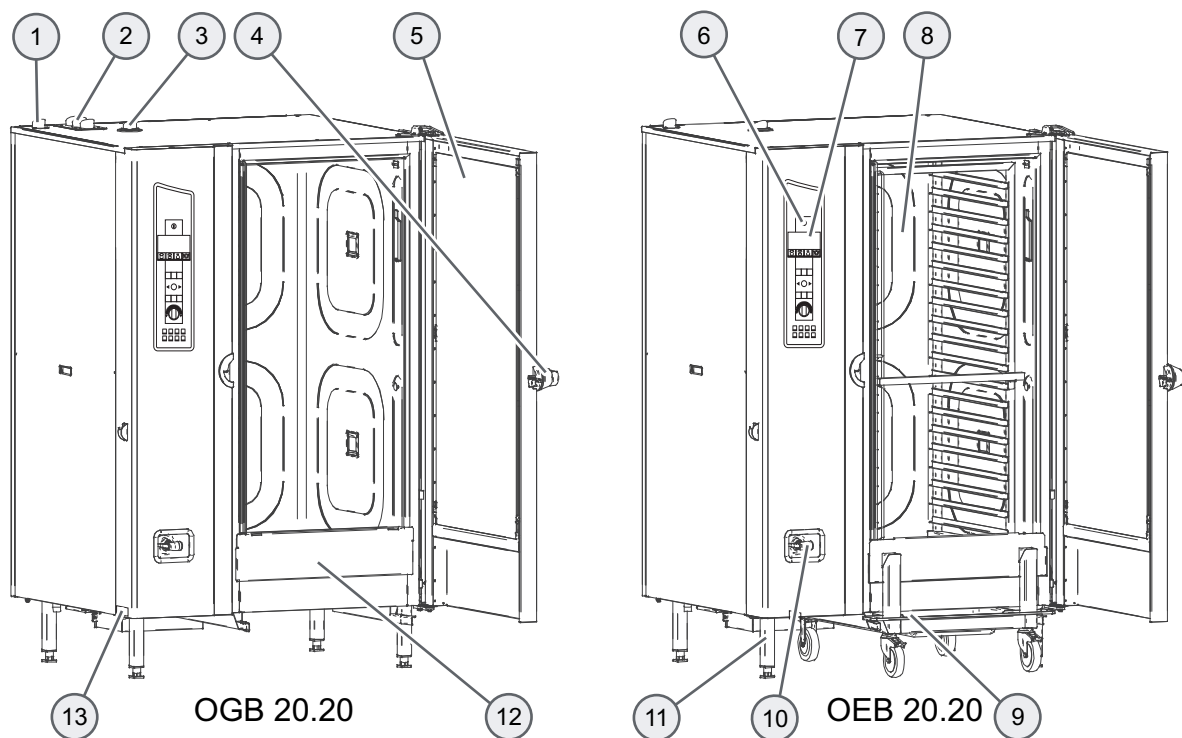

Components of the floor-standing appliances and their function

The components of the table-top appliances have the following function:

No.	Name Picture	Function
1	Air vent	Controls ventilation
2	Gas flue pipe	On gas appliances only (vents flue gases): <ul style="list-style-type: none"> ▪ 1 gas flue pipes: OGS 12.20 ▪ 2 gas flue pipes: OGB 12.20, OGS 20.10, 20.20 ▪ 3 gas flue pipes: OGB 20.10, 20.20
3	Low-pressure failsafe device	Prevents the low pressure in the oven e.g. during fully automatic cleaning (CONVOClean system)
4	Multi-function door handle ("Hygienic Handle")	Has the following functions depending on its position: <ul style="list-style-type: none"> ▪ Pointing vertically downwards: combi steamer closed ▪ Horizontal: combi steamer open, in on-latch position ▪ 20 degrees above horizontal: Combi steamer can be opened Also has the following functions: <ul style="list-style-type: none"> ▪ Additional function as far as on-latch position ▪ In the on-latch position, door can be opened from inside oven in an emergency ▪ Antibacterial with silver ions
5	Appliance door ("disappearing door")	<ul style="list-style-type: none"> ▪ Seals the oven during cooking ▪ Special opening action allows it to slide back against the side of the combi steamer to save space
6		Switches the combi steamer on and off
7	Control panel	Central control of the combi steamer: <ul style="list-style-type: none"> ▪ Controls: membrane keypad and tilt selector switch ▪ Status displays
8	Oven	<ul style="list-style-type: none"> ▪ Contains the food during cooking ▪ Has a different number of shelf levels depending on model
9	Loading trolley	Used for loading food
10	Hand shower	<ul style="list-style-type: none"> ▪ Used for rinsing out the oven with water. ▪ Continuous flow adjustment
11	Appliance feet	Can be adjusted in height to allow the combi steamer to be positioned horizontally
12	Preheat bridge	Used for safety purposes during preheating and cleaning
13	Type plate	Used for identifying the combi steamer

Basic principle of operation

In your combi steamer you can cook a range of food. The combi steamer can employ the following main cooking programs to do this:

- Steam
- Convection
- Superheated steam.

You can use these main cooking programs to cook food in almost all possible ways. The main cooking programs can be applied to the following cooking techniques:

- | | | |
|-------------|--------------|---------------------------|
| ▪ Steaming | ▪ Braising | ▪ Low-temperature cooking |
| ▪ Blanching | ▪ Baking | ▪ Defrosting |
| ▪ Poaching | ▪ scalloping | ▪ Sous-vide cooking |
| ▪ Stew | ▪ Grilling | ▪ ΔT cooking |
| ▪ Boiling | ▪ Gratinate | ▪ Cook & Hold |
| ▪ Roasting | ▪ Regenerate | ▪ Overnight cooking |

Basic procedure for working with your combi steamer

These are the basic principles of working with the combi steamer:

- Place food, held in containers or on shelf racks, into your combi steamer.
 - Set the cooking program, the cooking temperature or core temperature and start the combi steamer.
 - Once the cooking program has finished, take out the food, which is in the required state.
-

► Technical data for OES

Dimensions and weights

The following table shows appliance dimensions and weights:

OES		6.10	6.20	10.10	10.20	12.20	20.10	20.20	
		Table-top appliances				Floor-standing appliances			
Width									
with packaging	[mm]	1130	1410	1130	1410	1435	1150	1435	
without packaging	[mm]	932	1217	932	1217	1232	947	1232	
Depth						including loading trolley			
with packaging	[mm]	950	1175	950	1175	1200	1000	1200	
without packaging	[mm]	805	1027	805	1027	1055	855	1055	
Height						including loading trolley			
with packaging	[mm]	1040	1105	1310	1330	1650	2185	2185	
without packaging	[mm]	852	895	1120	1120	1416	1952	1952	
Weight						including loading trolley			
with packaging	[kg]	151	206	175	250	330	324	428	
without packaging	[kg]	125	169	148	212	277	281	372	
Weight with ConvoClean system						including loading trolley			
with packaging	[kg]	156	211	180	255	335	329	433	
without packaging	[kg]	130	174	153	217	282	286	377	
Safety clearances									
Rear	[mm]	50	50	50	50	50	50	50	
Right-hand side	[mm]	50	50	50	50	50	50	50	
Left-hand side*	[mm]	50	50	50	50	50	50	50	
Above**	[mm]	500	500	500	500	500	500	500	

* a larger gap is recommended for servicing purposes

** for ventilation

Maximum permissible loading weight

The following table shows the maximum permissible loading weight per combi steamer. These values are based on the condition that each shelf can take a maximum load of 15 kg:

Maximum permissible loading weight		6.10	6.20	10.10	10.20	12.20	20.10	20.20
GN (containers, shelf-grills, baking trays)								
per combi steamer	[kg]	30	60	50	100	120	100	180
per shelf	[kg]	15	15	15	15	15	15	15
600 x 400 tray (containers, shelf-grills, baking trays)								
with packaging	[kg]	30	60	50	100	120	100	180
without packaging	[kg]	15	15	15	15	15	15	15

Electrical installed load ratings

The following table shows the electrical installed load ratings:

OES		6.10	6.20	10.10	10.20	12.20	20.10	20.20
		Table-top appliances			Floor-standing appliances			
3~ 400V 50/60Hz (3/N/PE)								
Rated power consumption	[kW]	11,4	19,8	19,8	34,3	34,3	39,6	68,5
Convection power	[kW]	10,5	18,9	18,9	33,0	33,0	37,8	66,0
Motor power	[kW]	0,8	0,8	0,8	1,2	1,2	1,7	2,4
Rated current	[A]	15,3	26,3	26,3	47,6	47,6	52,4	95,0
max. permissible system impedance Z_{sys}	[Σ]	0,627	0,252	0,252	0,113	0,113	0,125	-
Fuse	[A]	16	35	35	50	50	63	100
recommended conductor cross-section*	[mm ²]	5G4	5G6	5G6	5G16	5G16	5G16	5G35
Heat output								
latent	[kJ/h]	2100	3500	3500	6400	6900	6900	12200
sensible	[kJ/h]	2500	4500	4500	7800	7800	8900	15400
3~ 230V 50/60Hz (3/PE)								
Rated power consumption	[kW]	11,7	20,1	20,1	34,6	34,6	40,1	69,1
Convection power	[kW]	10,5	18,9	18,9	33,0	33,0	37,8	66,0
Motor power	[kW]	0,8	0,8	0,8	1,5	1,5	2,2	3,0
Rated current	[A]	27,2	46,2	46,2	83,5	83,5	92,3	166,9
max. permissible system impedance Z_{sys}	[Σ]	0,239	0,151	0,151	-	-	-	-
Fuse	[A]	35	50	50	100	100	100	200
recommended conductor cross-section*	[mm ²]	5G6	5G16	5G16	5G35	5G35	5G35	5G95
3~ 200V 50/60Hz (3/PE)								
Rated power consumption	[kW]	11,7	20,1	20,1	34,6	34,6	40,1	69,1
Convection power	[kW]	10,5	18,9	18,9	33,0	33,0	37,8	66,0
Motor power	[kW]	1,1	1,1	1,1	1,5	1,5	2,2	3,0
Rated current	[A]	30,8	52,7	52,7	95,4	95,4	105,2	190,6
max. permissible system impedance Z_{sys}	[Σ]	0,239	0,151	0,151	-	-	-	-
Fuse	[A]	35	63	63	100	100	125	200
recommended conductor cross-section*	[mm ²]	5G6	5G16	5G16	5G35	5G35	5G35	5G95

*recommended conductor cross-section for wires laid uncovered in air up to 5 m in length.

Appliance technical standards

The following table shows the technical standards for the appliance:

	6.10	6.20	10.10	10.20	12.20	20.10	20.20
	Table-top appliances				Floor-standing appliances		
Degree of protection	IPX5						
Approval mark*	TÜV/GS, DIN GOST TÜV, SVGW, WRAS, UL, NSF						
Noise emission							
measured [dBA]	< 70						

*The appliance only displays those approval marks relevant to the country of use.

Water supply

The following table shows the values for the water supply:

	6.10	6.20	10.10	10.20	12.20	20.10	20.20
	Table-top appliances				Floor-standing appliances		
Water supply (cold only)							
Shut-off device	with non-return valve (type EA) and dirt filter						
Water supply							
without ConvoClean system	G 3/4", permanent connection optional with min. DN 10 supply pipe						
with ConvoClean system	G 3/4", permanent connection optional with min. DN 10 supply pipe						
Flow pressure							
without ConvoClean system [kPa]	200 - 600 (2 - 6 bar)						
with ConvoClean system [kPa]	300 - 600 (3 - 6 bar)						
Water drain*							
Type DN	50	50	50	50	50	50	50

* Permanent connection (recommended) or funnel waste trap

Water quality

The following table shows the values for the water quality:

		Demoisturization, injection, cleaning	Condenser, hand shower
Drinking water quality (install water treatment unit if necessary)			
Total hardness (German degrees of hardness)	[°dH]	4 - 7	4 - 20
(French degrees of hardness)	[TH]	7 - 13	7 - 27
(English degrees of hardness)	[°e]	5 - 9	5 - 19
	[ppm]	70 - 125	70 - 270
	[mmol/l]	0,7 - 1,3	0,7 - 2,7
Temperature (T)	[°C]	max. 40	max. 40
Conductivity	[µS/cm]	min. 20	min. 20
pH		6,5 - 8,5	6,5 - 8,5
Cl-	[mg/l]	max. 100	max. 100
SO ₄ ²⁻	[mg/l]	max. 150	max. 150
Fe	[mg/l]	max. 0.1	max. 0.1

► Technical data for OGS

Dimensions and weights

The following table shows appliance dimensions and weights:

OGS		6.10	6.20	10.10	10.20	12.20	20.10	20.20	
		Table-top appliances				Floor-standing appliances			
Width						including loading trolley			
with packaging	[mm]	1130	1410	1130	1410	1435	1150	1435	
without packaging	[mm]	932	1217	932	1217	1232	947	1232	
Depth						including loading trolley			
with packaging	[mm]	950	1175	950	1175	1200	1000	1200	
without packaging	[mm]	805	1027	805	1027	1055	855	1055	
Height						including loading trolley			
with packaging	[mm]	1040	1105	1310	1330	1650	2185	2185	
without packaging	[mm]	852	895	1120	1120	1416	1952	1952	
Weight						including loading trolley			
with packaging	[kg]	157	216	183	267	339	350	459	
without packaging	[kg]	131	179	156	229	286	307	403	
Weight with ConvoClean system						including loading trolley			
with packaging	[kg]	163	221	188	272	344	355	467	
without packaging	[kg]	136	184	161	234	291	312	408	
Safety clearances									
Rear	[mm]	50	50	50	50	50	50	50	
Right-hand side	[mm]	50	50	50	50	50	50	50	
Left-hand side*	[mm]	50	50	50	50	50	50	50	
Above**	[mm]	500	500	500	500	500	500	500	

* a larger gap is recommended for servicing purposes

** for ventilation

Maximum permissible loading weight

The following table shows the maximum permissible loading weight per combi steamer. These values are based on the condition that each shelf can take a maximum load of 15 kg:

Maximum permissible loading weight		6.10	6.20	10.10	10.20	12.20	20.10	20.20	
GN (containers, shelf-grills, baking trays)									
per combi steamer	[kg]	30	60	50	100	120	100	180	
per shelf	[kg]	15	15	15	15	15	15	15	
600 x 400 tray (containers, shelf-grills, baking trays)									
with packaging	[kg]	30	60	50	100	120	100	180	
without packaging	[kg]	15	15	15	15	15	15	15	

Electrical installed load ratings

The following table shows the electrical installed load ratings:

OGS		6.10	6.20	10.10	10.20	12.20	20.10	20.20
		Table-top appliances			Floor-standing appliances			
3N~ 400V 50/60Hz (3/N/PE)								
Rated power consumption	[kW]	1,1	1,1	1,1	1,4	1,4	2,1	2,1
Rated current	[A]	2,5	2,5	2,5	3,2	3,2	4,7	5,0
Fuse	[A]	16	16	16	16	16	16	16
recommended conductor cross-section*	[mm ²]	5G2.5	5G2.5	5G2.5	5G2.5	5G2.5	5G2.5	5G2.5
3~ 230V 50/60Hz (3/PE)								
Rated power consumption	[kW]	1,3	1,3	1,3	1,7	1,7	2,5	2,6
Rated current	[A]	4,5	4,5	4,5	5,8	5,8	8,7	9,0
Fuse	[A]	16	16	16	16	16	16	16
recommended conductor cross-section*	[mm ²]	5G2.5	5G2.5	5G2.5	5G2.5	5G2.5	5G2.5	5G2.5

*recommended conductor cross-section for wires laid uncovered in air up to 5 m in length.

Gas supply

The following table shows the values for the gas supply:

	6.10	6.20	10.10	10.20	12.20	20.10	20.20	
	Table-top appliances			Floor-standing appliances				
Fuels	Natural gas, liquid gas							
Flue gas connection	Air conditioning system with safety shutdown							

Appliance technical standards

The following table shows the technical standards for the appliance:

	6.10	6.20	10.10	10.20	12.20	20.10	20.20	
	Table-top appliances			Floor-standing appliances				
Degree of protection	IPX5							
Approval mark*	Gastec QA, DIN GOST TÜV, SVGW, WRAS, UL, NSF, JIA, AGA							
Noise emission								
measured	[dBA]	< 70						

*The appliance only displays those approval marks relevant to the country of use.

Water supply

The following table shows the values for the water supply:

		6.10	6.20	10.10	10.20	12.20	20.10	20.20
		Table-top appliances			Floor-standing appliances			
Water supply (cold only)								
Shut-off device		with non-return valve (type EA) and dirt filter						
Water supply								
without ConvoClean system		G 3/4", permanent connection optional with min. DN 10 supply pipe						
with ConvoClean system		G 3/4", permanent connection optional with min. DN 10 supply pipe						
Flow pressure								
without ConvoClean system	[kPa]	200 - 600 (2 - 6 bar)						
with ConvoClean system	[kPa]	300 - 600 (3 - 6 bar)						
Water drain*								
Type	DN	50	50	50	50	50	50	50

* Permanent connection (recommended) or funnel waste trap

Water quality

The following table shows the values for the water quality:

		Demoisturization, injection, cleaning		Condenser, hand shower cleaning	
Drinking water quality (install water treatment unit if necessary)					
Total hardness (German degrees of hardness)	[°dH]	4 - 7		4 - 20	
(French degrees of hardness)	[TH]	7 - 13		7 - 27	
(English degrees of hardness)	[°e]	5 - 9		5 - 19	
	[ppm]	70 - 125		70 - 270	
	[mmol/l]	0,7 - 1,3		0,7 - 2,7	
Temperature (T)	[°C]	max. 40		max. 40	
Conductivity	[µS/cm]	min. 20		min. 20	
pH		6,5 - 8,5		6,5 - 8,5	
Cl-	[mg/l]	max. 100		max. 100	
SO ₄ ²⁻	[mg/l]	max. 150		max. 150	
Fe	[mg/l]	max. 0.1		max. 0.1	

► Technical data for OEB

Dimensions and weights

The following table shows appliance dimensions and weights:

OEB		6.10	6.20	10.10	10.20	12.20	20.10	20.20
		Table-top appliances			Floor-standing appliances			
Width					including loading trolley			
with packaging	[mm]	1130	1410	1130	1410	1435	1150	1435
without packaging	[mm]	932	1217	932	1217	1232	947	1232
Depth					including loading trolley			
with packaging	[mm]	950	1175	950	1175	1200	1000	1200
without packaging	[mm]	805	1027	805	1027	1055	855	1055
Height					including loading trolley			
with packaging	[mm]	1040	1105	1310	1330	1650	2185	2185
without packaging	[mm]	852	895	1120	1120	1416	1952	1952
Weight					including loading trolley			
with packaging	[kg]	158	225	187	265	345	342	448
without packaging	[kg]	132	188	160	227	292	299	392
Weight with ConvoClean system					including loading trolley			
with packaging	[kg]	163	230	192	270	350	357	455
without packaging	[kg]	137	193	165	232	297	304	397
Safety clearances								
Rear	[mm]	50	50	50	50	50	50	50
Right-hand side	[mm]	50	50	50	50	50	50	50
Left-hand side*	[mm]	50	50	50	50	50	50	50
Above**	[mm]	500	500	500	500	500	500	500

* a larger gap is recommended for servicing purposes

** for ventilation

Maximum permissible loading weight

The following table shows the maximum permissible loading weight per combi steamer. These values are based on the condition that each shelf can take a maximum load of 15 kg:

Maximum permissible loading weight		6.10	6.20	10.10	10.20	12.20	20.10	20.20
GN (containers, shelf-grills, baking trays)								
per combi steamer	[kg]	30	60	50	100	120	100	180
per shelf	[kg]	15	15	15	15	15	15	15
600 x 400 tray (containers, shelf-grills, baking trays)								
with packaging	[kg]	30	60	50	100	120	100	180
without packaging	[kg]	15	15	15	15	15	15	15

Electrical installed load ratings

The following table shows the electrical installed load ratings:

OEB		6.10	6.20	10.10	10.20	12.20	20.10	20.20
		Table-top appliances			Floor-standing appliances			
3N~ 400V 50/60Hz (3/N/PE)								
Rated power consumption	[kW]	11,5	19,9	19,9	34,4	34,4	39,7	68,6
Convection power	[kW]	10,5	18,9	18,9	33,0	33,0	37,8	66,0
Steam power	[kW]	9,9	16,5	16,5	26,4	29,7	29,7	39,6
Motor power	[kW]	0,8	0,8	0,8	1,2	1,2	1,7	2,4
Rated current	[A]	15,7	26,6	26,6	48,0	48,0	52,8	95,4
max. permissible system impedance Z_{sys}	[Σ]	0,627	0,252	0,252	0,113	0,113	0,125	-
Fuse	[A]	16	35	35	50	50	63	100
recommended conductor cross-section*	[mm ²]	5G4	5G6	5G6	5G16	5G16	5G16	5G35
Heat output								
latent	[kJ/h]	2100	3500	3500	6400	6900	6900	12200
sensible	[kJ/h]	2500	4500	4500	7800	7800	8900	15400
3~ 230V 50/60Hz (3/PE)								
Rated power consumption	[kW]	11,8	20,2	20,2	34,7	34,7	40,2	69,2
Convection power	[kW]	10,5	18,9	18,9	33,0	33,0	37,8	66,0
Steam power	[kW]	9,9	16,5	16,5	26,4	29,7	29,7	39,6
Motor power	[kW]	0,8	0,8	0,8	1,5	1,5	2,2	3,0
Rated current	[A]	27,6	46,6	46,6	83,9	83,9	92,7	167,3
max. permissible system impedance Z_{sys}	[Σ]	0,239	0,151	0,151	-	-	-	-
Fuse	[A]	35	50	50	100	100	100	200
recommended conductor cross-section*	[mm ²]	5G6	5G16	5G16	5G35	5G35	5G35	5G95
3~ 200V 50/60Hz (3/PE)								
Rated power consumption	[kW]	11,8	20,2	20,2	34,7	34,7	40,2	69,2
Convection power	[kW]	10,5	18,9	18,9	33,0	33,0	37,8	66,0
Motor power	[kW]	1,1	1,1	1,1	1,5	1,5	2,2	3,0
Steam power	[kW]	9,9	16,5	16,5	26,4	29,7	29,7	39,6
Rated current	[A]	9,9	16,5	16,5	26,4	29,7	29,7	39,6
max. permissible system impedance Z_{sys}	[Σ]	0,239	0,151	0,151	-	-	-	-
Fuse	[A]	35	63	63	100	100	125	200
recommended conductor cross-section*	[mm ²]	5G6	5G16	5G16	5G35	5G35	5G35	5G95

*recommended conductor cross-section for wires laid uncovered in air up to 5 m in length.

Appliance technical standards

The following table shows the technical standards for the appliance:

	6.10	6.20	10.10	10.20	12.20	20.10	20.20
	Table-top appliances				Floor-standing appliances		
Degree of protection	IPX5						
Approval mark*	TÜV/GS, DIN GOST TÜV, SVGW, WRAS, UL, NSF						
Noise emission							
measured [dBA]	< 70						

*The appliance only displays those approval marks relevant to the country of use.

Water supply

The following table shows the values for the water supply:

	6.10	6.20	10.10	10.20	12.20	20.10	20.20
	Table-top appliances				Floor-standing appliances		
Water supply (cold only)							
Shut-off device	with non-return valve (type EA) and dirt filter						
Water supply							
without ConvoClean system	G 3/4", permanent connection optional with min. DN 10 supply pipe						
with ConvoClean system	G 3/4", permanent connection optional with min. DN 10 supply pipe						
Flow pressure							
without ConvoClean system [kPa]	200 - 600 (2 - 6 bar)						
with ConvoClean system [kPa]	300 - 600 (3 - 6 bar)						
Water drain*							
Type DN	50	50	50	50	50	50	50

* Permanent connection (recommended) or funnel waste trap

Water quality

The following table shows the values for the water quality:

		Moisture removal, steam generator, cleaning	Condenser, hand shower
Drinking water quality (install water treatment unit if necessary)			
Total hardness (German degrees of hardness)	[°dH]	4 - 7	4 - 20
(French degrees of hardness)	[TH]	7 - 13	7 - 27
(English degrees of hardness)	[°e]	5 - 9	5 - 19
	[ppm]	70 - 125	70 - 270
	[mmol/l]	0,7 - 1,3	0,7 - 2,7
Temperature (T)	[°C]	max. 40	max. 40
Conductivity	[µS/cm]	min. 20	min. 20
pH		6,5 - 8,5	6,5 - 8,5
Cl ⁻	[mg/l]	max. 100	max. 100
SO ₄ ²⁻	[mg/l]	max. 150	max. 150
Fe	[mg/l]	max. 0.1	max. 0.1

► Technical data for OGB

Dimensions and weights

The following table shows appliance dimensions and weights:

OGB		6.10	6.20	10.10	10.20	12.20	20.10	20.20	
		Table-top appliances				Floor-standing appliances			
Width						including loading trolley			
with packaging	[mm]	1130	1410	1130	1410	1435	1150	1435	
without packaging	[mm]	932	1217	932	1217	1232	947	1232	
Depth						including loading trolley			
with packaging	[mm]	950	1175	950	1175	1200	1000	1200	
without packaging	[mm]	805	1027	805	1027	1055	855	1055	
Height						including loading trolley			
with packaging	[mm]	1040	1105	1310	1330	1650	2185	2185	
without packaging	[mm]	852	895	1120	1120	1416	1952	1952	
Weight						including loading trolley			
with packaging	[kg]	180	243	205	292	375	394	505	
without packaging	[kg]	154	206	178	254	322	351	449	
Weight with ConvoClean system						including loading trolley			
with packaging	[kg]	185	248	210	297	380	399	510	
without packaging	[kg]	159	211	183	259	327	356	454	
Safety clearances									
Rear	[mm]	50	50	50	50	50	50	50	
Right-hand side	[mm]	50	50	50	50	50	50	50	
Left-hand side*	[mm]	50	50	50	50	50	50	50	
Above**	[mm]	500	500	500	500	500	500	500	

* a larger gap is recommended for servicing purposes

** for ventilation

Maximum permissible loading weight

The following table shows the maximum permissible loading weight per combi steamer. These values are based on the condition that each shelf can take a maximum load of 15 kg:

Maximum permissible loading weight		6.10	6.20	10.10	10.20	12.20	20.10	20.20	
GN (containers, shelf-grills, baking trays)									
per combi steamer	[kg]	30	60	50	100	120	100	180	
per shelf	[kg]	15	15	15	15	15	15	15	
600 x 400 tray (containers, shelf-grills, baking trays)									
with packaging	[kg]	30	60	50	100	120	100	180	
without packaging	[kg]	15	15	15	15	15	15	15	

Electrical installed load ratings

The following table shows the electrical installed load ratings:

OGB		6.10	6.20	10.10	10.20	12.20	20.10	20.20
		Table-top appliances			Floor-standing appliances			
3N~ 400V 50/60Hz (3/N/PE)								
Rated power consumption	[kW]	1,2	1,2	1,2	1,5	1,5	2,2	2,2
Rated current	[A]	2,9	2,9	2,9	3,6	3,6	5,1	5,4
Fuse	[A]	16	16	16	16	16	16	16
recommended conductor cross-section*	[mm ²]	5G2.5	5G2.5	5G2.5	5G2.5	5G2.5	5G2.5	5G2.5
3~ 230V 50/60Hz (3/PE)								
Rated power consumption	[kW]	1,4	1,4	1,4	1,8	1,8	2,6	2,7
Rated current	[A]	4,9	4,9	4,9	6,2	6,2	9,1	9,4
Fuse	[A]	16	16	16	16	16	16	16
recommended conductor cross-section*	[mm ²]	5G2.5	5G2.5	5G2.5	5G2.5	5G2.5	5G2.5	5G2.5

*recommended conductor cross-section for wires laid uncovered in air up to 5 m in length.

Gas supply

The following table shows the values for the gas supply:

	6.10	6.20	10.10	10.20	12.20	20.10	20.20	
	Table-top appliances			Floor-standing appliances				
Fuels	Natural gas, liquid gas							
Flue gas connection	Air conditioning system with safety shutdown							

Appliance technical standards

The following table shows the technical standards for the appliance:

	6.10	6.20	10.10	10.20	12.20	20.10	20.20	
	Table-top appliances			Floor-standing appliances				
Degree of protection	IPX5							
Approval mark*	Gastec QA, DIN GOST TÜV, SVGW, WRAS, UL, NSF, JIA, AGA							
Noise emission								
measured	[dBA]	< 70						

*The appliance only displays those approval marks relevant to the country of use.

Water supply

The following table shows the values for the water supply:

		6.10	6.20	10.10	10.20	12.20	20.10	20.20
		Table-top appliances			Floor-standing appliances			
Water supply (cold only)								
Shut-off device		with non-return valve (type EA) and dirt filter						
Water supply								
without ConvoClean system		G 3/4", permanent connection optional with min. DN 10 supply pipe						
with ConvoClean system		G 3/4", permanent connection optional with min. DN 10 supply pipe						
Flow pressure								
without ConvoClean system	[kPa]	200 - 600 (2 - 6 bar)						
with ConvoClean system	[kPa]	300 - 600 (3 - 6 bar)						
Water drain*								
Type	DN	50	50	50	50	50	50	50

* Permanent connection (recommended) or funnel waste trap

Water quality

The following table shows the values for the water quality:

		Moisture removal, steam generator, cleaning		Condenser, hand shower	
Drinking water quality (install water treatment unit if necessary)					
Total hardness (German degrees of hardness)	[°dH]	4 - 7		4 - 20	
(French degrees of hardness)	[TH]	7 - 13		7 - 27	
(English degrees of hardness)	[°e]	5 - 9		5 - 19	
	[ppm]	70 - 125		70 - 270	
	[mmol/l]	0,7 - 1,3		0,7 - 2,7	
Temperature (T)	[°C]	max. 40		max. 40	
Conductivity	[µS/cm]	min. 20		min. 20	
pH		6,5 - 8,5		6,5 - 8,5	
Cl-	[mg/l]	max. 100		max. 100	
SO ₄ ²⁻	[mg/l]	max. 150		max. 150	
Fe	[mg/l]	max. 0.1		max. 0.1	

3 For your safety

Purpose of this chapter

This chapter provides you with all the information you need in order to use the combi steamer safely without putting yourself or others at risk.

This is a particularly important chapter that you should read through carefully.

Contents

This chapter contains the following topics:

	Page
Basic safety code	37
Warning signs on the combi steamer	38
Summary of hazards	40
Hazards and safety precautions	43
Safety devices	46
Requirements to be met by personnel, working positions	48
Personal protection equipment	49

▶ Basic safety code

Object of this safety code

This safety code aims to ensure that all persons who use the combi steamer have a thorough knowledge of the hazards and safety precautions, and that they follow the safety instructions given in the user manual and on the combi steamer. If you do not follow this safety code, you risk potentially fatal injury and property damage.

Referring to the user manuals included in the customer documentation

Follow the instructions below:

- Read in full the chapter "For Your Safety" and the chapters that relate to your work.
- Always keep to hand the user manuals included in the customer documentation for reference.
- Pass on the user manuals included in the customer documentation with the combi steamer if it changes ownership.

Working with the combi steamer

Follow the instructions below:

- Only those persons who satisfy the requirements stipulated in this user manual are permitted to use the combi steamer.
- People (including children) who, because of their physical, sensory or intellectual capabilities, or because of their lack of experience or knowledge, are incapable of using the appliance safely, must not use this equipment without the supervision or guidance of a responsible person.
- Only use the combi steamer for the specified use. Never, under any circumstances, use the combi steamer for other purposes that may suggest themselves.
- Take all the safety precautions specified in this user manual and on the combi steamer. In particular, use the prescribed personal protection equipment.
- Only stand in the working positions specified.
- Do not make any changes to the combi steamer, e.g. removing parts or fitting un-approved parts. In particular, you must not disable any safety devices.

More on this

Related topics

□ Warning signs on the combi steamer	38
□ Summary of hazards	40
□ Hazards and safety precautions	43
□ Safety devices	46
□ Requirements to be met by personnel, working positions	48
□ Personal protection equipment	49

► Warning signs on the combi steamer

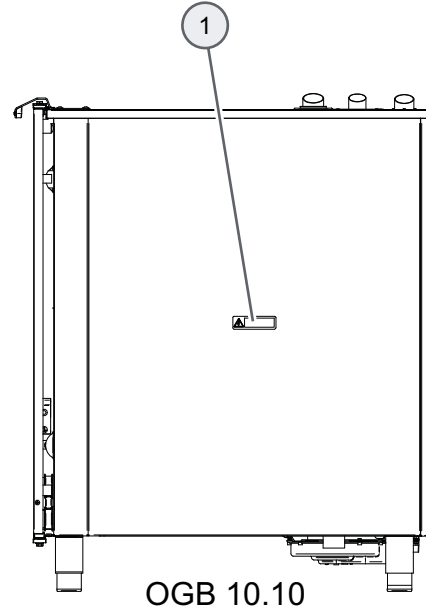
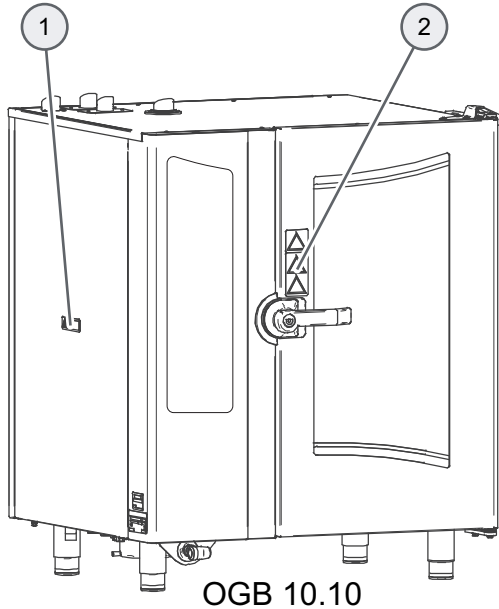

Where are the warning signs fitted?

The warning signs are located in the following positions on the combi steamer:



Warnings on the appliance door

The following warning signs are fitted on the appliance door above the door handle (2):

Warning sign	Description
	Warning of hot liquids Spillage of hot liquid foods can result in scalds if the upper shelves are loaded with liquids or foods that produce liquid during cooking. Shelves above the level marked by this warning sign (1.60 m) may not be seen by all users and should not, therefore, be used for liquids or foods that produce liquid during cooking.
	Warning of hot steam and vapor There is a risk of scalding from hot steam and vapor escaping when the appliance door is opened.
	Warning of corrosive cleaning agents injected into oven If the appliance door is opened during fully automatic cleaning (<i>CONVOClean system</i>), there is a risk of chemical skin burns from contact with cleaning agents being injected during the cleaning program.

Warning signs on the side cover of the combi steamer

The following warning signs are fitted on the side cover (1) of the combi steamer:

Warning sign	Description
	Warning of electric shock There is a risk of electric shock from live parts if the appliance cover is opened.

Warning signs on the loading trolley for floor-standing appliances

The following warning signs are fitted on the loading trolley of floor-standing appliances:

Warning sign	Description
	Warning of hot liquids Spillage of hot liquid foods can result in scalds if the upper shelves are loaded with liquids or foods that produce liquid during cooking. Shelves above the level marked by this warning sign (1.60 m) may not be seen by all users and should not, therefore, be used for liquids or foods that produce liquid during cooking.

► Summary of hazards

General rules for dealing with hazards and safety precautions

The combi steamer is designed to protect the user from all hazards that can reasonably be avoided by design measures.

The actual purpose of the combi steamer, however, means that there are still residual risks; you must therefore take precautions to avoid them. A safety device can provide you with a certain degree of protection against some of these hazards. You must ensure, however, that these safety devices are in place and in working order.

The nature of these residual risks and what effect they have are described below.

Hazard points

The following diagram shows the hazard points:

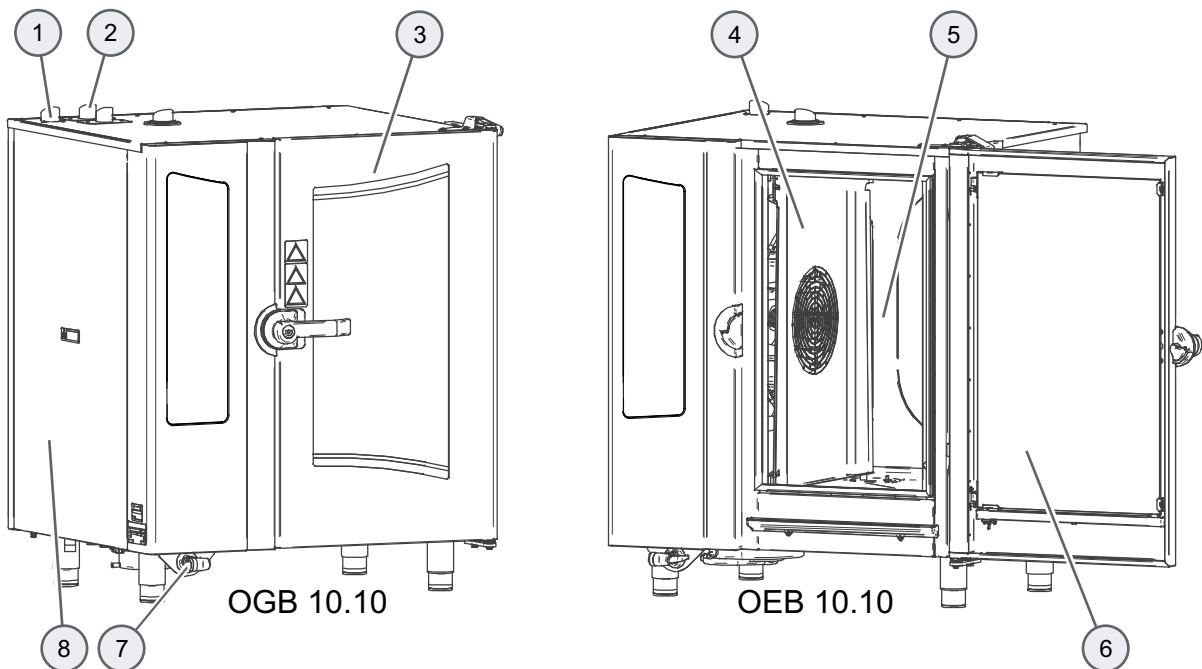

Heat generation

The combi steamer becomes hot inside the oven (5), on the inside (6) of the appliance door and on the gas flue pipe (2). This poses:

- A fire risk from heat given off by the combi steamer
- a risk of burns on hot surfaces outside and inside the combi steamer, and also on hot appliance parts and food containers

Hot steam / vapor

The combi steamer generates hot steam or vapor, which escapes when the door is opened, and which is removed through the air vent on the top of the combi steamer when the door is closed. This poses:

- A risk of scalding from hot steam when the appliance door (3) is opened. You are protected from the hot steam by the appliance door itself and its special functions (slow, staged opening procedure), provided you use these functions and ensure that the appliance door is intact.
- Risk of scalding from hot steam if water is sprayed into hot fat held inside the oven (5).
- Risk of scalding from high temperatures at the air vent (1) and on the gas flue pipe (2).

Hot liquids

Foodstuffs are cooked in the combi steamer. These foodstuffs may also be liquid, or liquefy during cooking. This poses:

- a risk of scalding from hot liquids, which may be spilled if not handled properly

Live components

The combi steamer contains live parts. This means:

- a risk from live parts if the cover (8) is not in place.
- a risk of electric shock if the combi steamer is cleaned externally using the hand shower (7).

Fan

The combi steamer contains a fan. This poses:

- a risk of hand injuries from the fan in the oven behind the suction panel (4) if the suction panel is not fitted in place properly.

Cleaning agents

The combi steamer must be cleaned using special cleaners. This poses:

- A risk from cleaning agents, some of which can cause skin burns.

Hand shower

There is a hand shower (7) on the combi steamer that can result in various hazards:

- a risk of scalding if water is sprayed into the hot oven using the hand shower, e.g. for cleaning.
- A risk of scalding when the combi steamer is located in the immediate vicinity of equipment for heating liquid fat, and water is sprayed into this equipment with the hand shower.
- a risk of scalding if a container of hot fat is standing in the oven into which water is sprayed with the hand shower.
- a risk of electric shock if the combi steamer is cleaned externally using the hand shower (7).

gas

If you have a gas appliance (OGx yy.zz), this poses additional hazards:

- Explosion risk if a gas pipe is faulty or leaking
- a risk of burns from hot flue gas at the gas flue pipe (2)
- a fire risk from hot flue gas above the gas appliance
- a risk of CO build-up in the kitchen where burners are poorly adjusted, there is an insufficient supply of air for combustion and/or insufficient removal of flue gas.

Loading the oven in advance

When loading the oven ahead of time, e.g. for pre-setting the start time of the cooking program, the cold chain of chilled foodstuffs may be broken. This poses:

- a risk to your guests from microbiological contamination of foodstuffs

For your safety

Interrupting cooking

Micro-organisms may multiply if cooking is interrupted. This poses:

- a risk to your guests from microbial contamination of foodstuffs.

Risk of hands being crushed

For various actions, such as opening/shutting the appliance door or cleaning the appliance door, there is the risk that you will crush or cut your hand.

► Hazards and safety precautions

Operation of electric and gas appliances

When operating the combi steamer, be aware of the following hazards and take the specified preventive actions:

Hazard	Where or in what situations does the hazard arise?	Preventive action	Safety device
A fire risk from heat given off by the combi steamer	When flammable gases or liquids are stored near the combi steamer.	Do not store flammable gases or liquids near the combi steamer.	None
Risk of burns from hot surfaces	Outside of appliance door	Do not touch surfaces for any length of time	None
	<ul style="list-style-type: none"> ▪ Inside the whole interior, including all parts that are inside during cooking, such as <ul style="list-style-type: none"> ▪ Racks ▪ Suction panel ▪ Core temperature sensor ▪ Shelf-grills etc. ▪ On the inside of the appliance door ▪ On the transport trolley ▪ On the loading trolley 	Wear specified protective clothing, in particular protective gloves	None
Risk of scalding from water jet from hand shower	If a container of hot fat is standing in the oven into which water is sprayed with the hand shower.	Do not spray into liquid fat	None
Risk of scalding from hot liquid	<ul style="list-style-type: none"> ▪ Inside oven ▪ Outside the combi steamer 	<ul style="list-style-type: none"> ▪ Only load containers holding liquid or liquefying food into shelf levels that allow a proper view inside the container, and always hold horizontally when removing ▪ Wear protective gloves ▪ Engage the transport securing mechanism of the shelf rack on the transport trolley ▪ Always cover hot liquids when conveying them on the transport trolley or loading trolley. ▪ Take care not to tilt the transport trolley or loading trolley. This may occur if the trolley is moved over an uneven surface or collides with an obstacle. 	None
Risk of scalding from hot steam	In front of the combi steamer	Check safety device	Appliance door:
	In front of the appliance door	<ul style="list-style-type: none"> ▪ use safety device ▪ Check safety device ▪ Do not put your head in the oven 	On-latch position of appliance door
	In front of the appliance door	On floor-standing appliances: use safety device	Preheat bridge

Hazard	Where or in what situations does the hazard arise?	Preventive action	Safety device
Risk of burns from hot vented air	Air vent on top of combi steamer	Do not get near it	None
Risk from live parts	Under the cover	Check safety device	Cover
Risk of hand injuries from fan	In oven	Check safety device	<ul style="list-style-type: none"> ▪ Suction panel ▪ Electrical cutout for appliance door
Risk of hand injuries from crushing	<ul style="list-style-type: none"> ▪ When inserting the loading trolley ▪ When closing the appliance door 	Exercise caution when performing these tasks	None
Risk from microbiological contamination of food	When the food cold-chain is broken by loading the oven in advance	Make sure that the cold chain is not broken: <ul style="list-style-type: none"> ▪ Do not store food temporarily in combi steamer ▪ Only allow qualified staff to perform low-temperature cooking (< 65 °C) 	None
	When cooking is interrupted	<ul style="list-style-type: none"> ▪ Do not interrupt the cooking process ▪ Do not store food temporarily in combi steamer 	None

Operation of gas appliances

When operating gas appliances, be aware of the following additional hazards and take the specified preventive actions:

Hazard	Where or in what situations does the hazard arise?	Preventive action	Safety device
Risk of explosion from gas	Where combi steamer is installed	On smelling gas: <ul style="list-style-type: none"> ▪ Cut off the gas supply ▪ Ventilate room ▪ Do not operate any electrical equipment ▪ Do not create naked flames ▪ Get help 	ventilation system
Risk of burns from flue gas	<ul style="list-style-type: none"> ▪ At the gas flue pipe ▪ On the cover 	Do not touch	None
Fire risk from hot flue gas	Above the gas appliance	Do not place any flammable materials above the combi steamer	None
Risk of CO build-up	Where combi steamer is installed	<ul style="list-style-type: none"> ▪ Do not obstruct the lower area of the appliance (device setup) ▪ Only operate in a draught-free environment ▪ Ensure that a ventilation system is in place ▪ Perform yearly maintenance on the appliance ▪ Turn off the appliance when not in use 	ventilation system

Cleaning

When cleaning the combi steamer, be aware of the following hazards and take the specified preventive actions:

Hazard	Where or in what situations does the hazard arise?	Preventive action	Safety device
Risk of electric shock	On the combi steamer	Do not clean the outside of the case with the hand shower	None
Risk of burns from hot surfaces	Inside the whole interior, including all parts that are inside during cooking, such as <ul style="list-style-type: none"> ▪ Racks ▪ Suction panel ▪ Core temperature sensor ▪ Shelf-grills, racks, etc. ▪ Loading trolley 	Wait until the interior has cooled to below 60 °C before cleaning	None
Risk of scalding from hot steam if water is sprayed into the hot oven using the hand shower	Inside the entire oven	Wait until the interior has cooled to below 60 °C before cleaning	None
Risk from cleaning agents	During fully automatic cleaning: <ul style="list-style-type: none"> ▪ In front of the appliance door 	Check safety device	<ul style="list-style-type: none"> ▪ Automatic rinsing ▪ Spray-guard
	During all cleaning tasks	<ul style="list-style-type: none"> ▪ Do not breathe in spray ▪ Wear personal protection equipment 	None
	When handling the cleaning canisters	Wear personal protection equipment	None
	When corrosive cleaning agents are used	Only use original cleaning agents	None
Risk of hand injuries from crushing	<ul style="list-style-type: none"> ▪ When cleaning the appliance door ▪ When cleaning the interior appliance door 	Exercise caution when performing these tasks	None

Maintenance

When performing maintenance work on the combi steamer, be aware of the following hazards and take the specified preventive actions:

Hazard	Where or in what situations does the hazard arise?	Preventive action	Safety device
Risk from live parts	<ul style="list-style-type: none"> ▪ Under the cover ▪ Under the control panel 	<ul style="list-style-type: none"> ▪ Work on the electrical system must only be performed by an approved customer service engineer ▪ Professional working ▪ Disconnect power supply before removing the cover 	Cover
Risk of hand injuries from fan	In wiring compartment	<ul style="list-style-type: none"> ▪ Disconnect power supply before removing the cover 	Cover

► Safety devices

Meaning

The combi steamer has a number of safety devices to protect the user from hazards. It is absolutely essential that all safety devices are fitted and in working order when operating the combi steamer

Position

The following diagrams show the location of the safety devices:

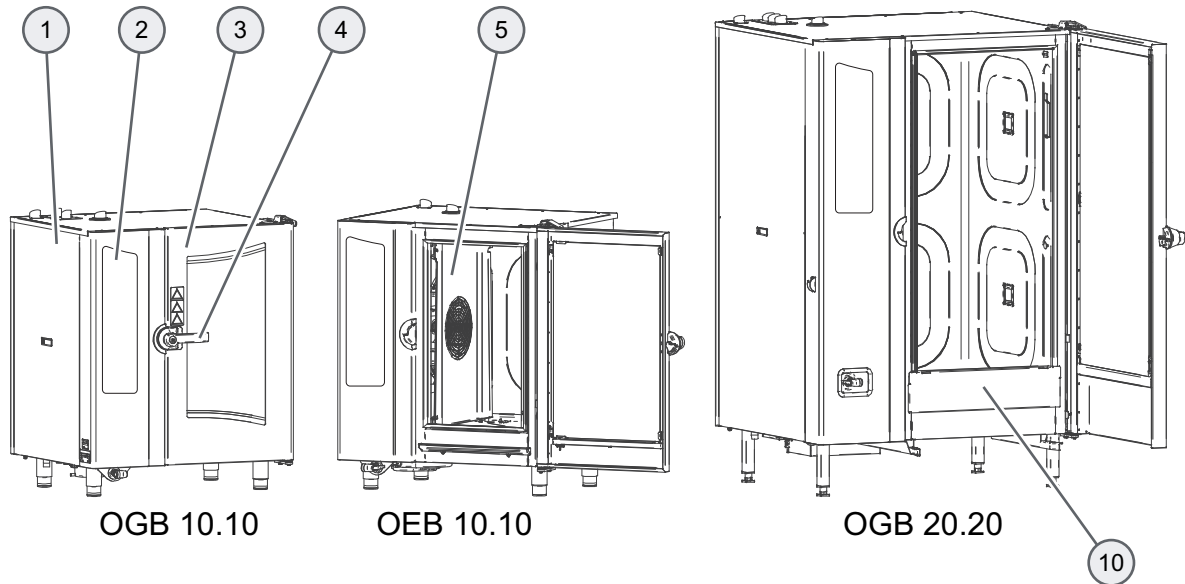

Functions

The following table enumerates all the safety devices on the combi steamer, explains their function and describes the check procedure:

No.	Safety device	Function	Check
1	Cover can only be removed using tool	<ul style="list-style-type: none"> Prevents live parts from being touched accidentally Prevents access to the moving fan from the wiring compartment 	Check that the cover is in place
2	Control panel can only be removed using a tool	Prevents live parts from being touched accidentally	Ensure that the control panel is in place
3	Appliance door:	Protects the operator and outside environment from hot steam	Check regularly for scratches, cracks, indentations etc. and replace door if any are found
4	On-latch position of appliance door	Prevents scalding of user's face and hands from escaping steam	Check door positions at low temperature as described in <i>Opening the appliance door safely</i> on page 165 in the user manual.
5	Suction panel in oven; can only be removed using tool	Prevents access to the moving fan and ensures good heat distribution.	See <i>Removing and fitting the suction panel</i> on page 180 in the user manual for further details.

No.	Safety device	Function	Check
6 (no picture)	Magnetic door switch: electrical door sensor in appliance door	Switches off the fan and heater when the appliance door is opened	Check magnetic door switch at low temperature: Action ▪ Open the appliance door fully ▪ Press Start Result Motor must not start up
7 (no picture)	Emergency opening in appliance door; Prevents anyone being locked inside the oven accidentally	Appliance door in the on-latch position: Allows the appliance door to be pushed open from the inside after shutting the door.	Check at low temperature: put the appliance door in the on- latch position (see <i>Opening the appliance door safely</i> on page 165 in the user manual) Action From the outside, pull forcefully on the top left of the appliance door Result The appliance door must open.
8 (no picture)	Automatic rinsing after power failure in case cleaning agent left in combi steamer	Re-starts fully automatic cleaning (CONVOclean system) in a de- fined state after power failure	This test is a software function. There is no need for the operator to perform a test.
9 (no picture)	Spray-guard	Stops the cleaning agent being injected during fully automatic cleaning (CONVOclean system) when the appliance door is opened Prompt to close the appliance door	The operability of the magnetic door switch is checked by the software at the beginning of each cleaning program
10	Preheat bridge	Prevents scalding from escaping steam when the loading trolley is not in the floor-standing appliance during preheating	See <i>Inserting and removing the pre- heat bridge (floor-standing appli- ances only)</i> on page 167 in the user manual for further details
11 (installed by customer)	Disconnection device	Installed by the customer close to the appliance; easily visible and accessible, 3-pole action, minimum contact separation 3 mm. Used to disconnect the appliance from the power supply during cleaning, repair and maintenance work and in case of danger.	Action ▪ Trip the disconnection device. ▪ Check at the X10 terminal strip on the appliance that there is no voltage at all three poles.
12 (installed by customer)	Gas shut-off device	Installed by customer close to appliance in easily accessible position and clearly labeled. Used to disconnect the appliance from the gas supply during clean- ing, repair and maintenance work and in case of danger.	Action ▪ Close gas shut-off device. ▪ Check that the appliance is isolated from the gas supply.

► Requirements to be met by personnel, working positions

Requirements to be met by personnel

Those people using the combi steamer must meet the following requirements:

Staff qualifications	Tasks	Personal protection equipment required	Chapter to read before task
Chef <ul style="list-style-type: none"> ▪ Has relevant professional training ▪ Knows relevant national food legislation and regulations, plus hygiene legislation and regulations ▪ Must keep records in accordance with HACCP ▪ Trained in how to operate the combi steamer 	Chef <ul style="list-style-type: none"> ▪ Entering cooking program data ▪ Editing recipes in the cookbook ▪ Managing default settings 	None	<ul style="list-style-type: none"> ▪ Layout and function ▪ For your safety ▪ Layout of the control panel ▪ How to operate the control panel ▪ Your combi steamer cooking programs ▪ Using the cooking programs ▪ How to customize the default settings
User <ul style="list-style-type: none"> ▪ Semiskilled ▪ Trained in how to operate the combi steamer 	User <ul style="list-style-type: none"> ▪ Loading / removing food ▪ Cleaning the combi steamer ▪ Fitting accessories in the combi steamer 	As specified in <i>Personal protection equipment</i> on page 49	<ul style="list-style-type: none"> ▪ Layout and function ▪ For your safety ▪ The instructions for "Switching the combi steamer on and off" in the chapter "How to operate the control panel" ▪ Cleaning and Maintenance ▪ How to do it correctly

Working positions during operation

The working position for staff when operating the combi steamer is in front of the appliance door.

Working positions during cleaning and maintenance

The working position for staff during cleaning and maintenance is the entire appliance area.

► Personal protection equipment

Operation

When operating the combi steamer, wear the following personal protection equipment:

Activity	Materials used	Protection equipment
Loading / removing food	None	Work wear as specified in country-specific standards and directives (BGR 111 in Germany) for kitchen work, in particular: <ul style="list-style-type: none"> ▪ Protective clothing ▪ Protective gloves ▪ Safety boots
Handling the core temperature sensor	None	Work wear as specified in country-specific standards and directives (BGR 111 in Germany) for kitchen work, in particular: <ul style="list-style-type: none"> ▪ Protective clothing ▪ Protective gloves ▪ Safety boots
Fitting accessories in the combi steamer	None	Work wear as specified in country-specific standards and directives (BGR 111 in Germany) for kitchen work, in particular: <ul style="list-style-type: none"> ▪ Protective clothing ▪ Protective gloves ▪ Safety boots

Cleaning

When cleaning the combi steamer, wear the following personal protection equipment:

Activity	Materials used	Protection equipment
<ul style="list-style-type: none"> ▪ Cleaning the combi steamer ▪ Handling cleaning canisters 	CONVOClean new	<ul style="list-style-type: none"> ▪ To protect against aerosols and mist created by cleaning fluid, breathing mask with type P2 / P3 particle filter ▪ Close-fitting safety goggles ▪ Nitrile-rubber gloves (rubber thickness 0.35 mm) recommended
<ul style="list-style-type: none"> ▪ Cleaning the combi steamer ▪ Handling cleaning canisters 	CONVOClean forte	<ul style="list-style-type: none"> ▪ To protect against aerosols and mist created by cleaning fluid, breathing mask with type P2 particle filter ▪ Close-fitting safety goggles ▪ Butyl-rubber gloves (rubber thickness 0.5 mm); nitrile-rubber gloves (rubber thickness 0.35mm); penetration time > 480 min ▪ Alkali-resistant protective clothing
<ul style="list-style-type: none"> ▪ Cleaning the combi steamer ▪ Handling cleaning canisters 	CONVOCare K	<ul style="list-style-type: none"> ▪ To protect against aerosols and mist created by cleaning fluid, breathing mask with type P2 particle filter ▪ Close-fitting safety goggles ▪ Butyl-rubber gloves (rubber thickness 0.5 mm); penetration time > 480 min

4 Layout of the control panel

Layout of the control panel on your combi steamer

Your combi steamer is operated using a membrane keypad. This means that all the combi steamer functions can be selected either directly using a button in the membrane keypad or via icons presented in the control-panel display.

In this chapter we show you the membrane keypad. We describe the icons (buttons) provided on the control panel and what they do.

Contents

This chapter contains the following topics:

	Page
Layout of the control panel	51
The controls	52
The Functions menu	54
The Cookbook menu	57
The Write/Edit menu	58

► Layout of the control panel

Layout of the control panel

The following diagram shows the layout of the control panel:

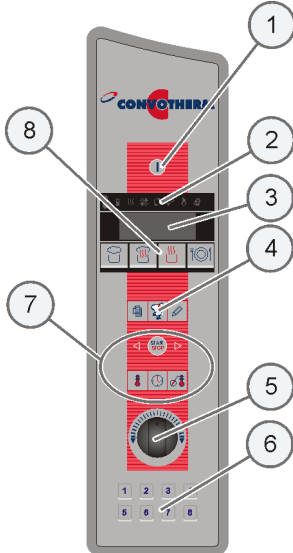















No.	Name	Function
1	ON/OFF switch	Switches the combi steamer on and off
2	Function indicators	The indicator lights up when the function is selected.
3	Display	In normal operating mode: Displays <ul style="list-style-type: none"> ▪ date, time, oven temperature, cooking time etc. In programming mode: Displays <ul style="list-style-type: none"> ▪ plain text, storage location number etc. ▪ icons of extra functions, special programs and default settings
4	Expert choice	<ul style="list-style-type: none"> ▪ For retrieving saved recipes ▪ For opening the selection submenu ▪ For creating/saving a recipe
5	Tilt selector switch	<ul style="list-style-type: none"> ▪ For setting the temperature, time etc. ▪ For selecting icons of extra functions, special programs and default settings ▪ For selecting program names, program numbers and recipes
6	Press&Go (optional for OES and OGS)	Selects and displays the quick selection. The supplied recipe stickers can be fixed to these buttons.
7	Data input	<ul style="list-style-type: none"> ▪ Program start/stop ▪ Scrolling in programming mode ▪ Selecting the temperature, time etc.
8	Main selection	Selects the main cooking program or regenerating program

► The controls









The buttons and what they do

The buttons in the control panel have the following meanings and functions:

Button	Meaning	Function
Main selection		
	Steam	Selects the Steam cooking program.
	Superheated steam	Selects the Superheated steam cooking program.
	Convection	Selects the Convection cooking program.
	Regenerate	Selects the regenerating program.
Expert choice		
	Cookbook menu	<ul style="list-style-type: none"> ▪ Opens the list of saved recipes. ▪ Opens the cookbook menu.
	Functions menu	Opens the Functions menu. Selection of <ul style="list-style-type: none"> ▪ Extra functions ▪ Special programs ▪ Default settings
	Write/Edit menu	<ul style="list-style-type: none"> ▪ Opens the Write/Edit menu. ▪ Confirms entries in the Cookbook menu.
Data input		
	Start / Stop	<ul style="list-style-type: none"> ▪ Starts the stops the cooking program. ▪ Starts the recipes from the cookbook. ▪ Closes the Functions menu.
	Cooking temperature	<ul style="list-style-type: none"> ▪ Opens the menu for setting the temperature. ▪ Displays the actual and target cooking temperature.
	Cooking time	<ul style="list-style-type: none"> ▪ Opens the menu for setting the cooking time. ▪ Displays the cooking time.
	Core temperature (optional for OES and OGS)	<ul style="list-style-type: none"> ▪ Opens the menu for setting the core temperature. ▪ Displays the core temperature.
	Scroll left	Goes back one step in programming mode.
	Scroll right	Goes forward one step in programming mode.
	Tilt selector switch	<ul style="list-style-type: none"> ▪ Adjusts the oven temperature, cooking time and core temperature. ▪ Selects the program name, program number and recipe. ▪ Selects the extra functions and editing functions.

The operating indicators and function indicators

The following table shows you the various operating indicators and function indicators. These are illuminated when the relevant function is active.

Indicator	Meaning	Function
	None	No function.
	Reduced power	The reduced power function is enabled. (Optional for OES)
	Heat required	The burner or electric heater is running.
	Lower fan speed	The reduced fan speed is enabled. (Optional for OES and OGS)
	Cooking	The appliance is running.
	Keypad lock	The keypad lock is enabled. <ul style="list-style-type: none"> ▪ Illuminated as soon as one key is locked ▪ Flickers when a locked key is pressed.
	Crisp&Tasty	Moisture removal is enabled.
	Program protection	Program protection is enabled. (Optional for OEB and OES)

► The Functions menu

The Functions menu

The icons in the Functions menu are shown in the display. The Functions menu can be opened using the following button:





The icons and what they do

The icons in the Functions menu have the following meanings and run the following functions:

Icon	Meaning	Function/program
	Crisp&Tasty	Opens the Crisp&Tasty submenu.
	Preheating	Program for preheating the oven.
	ΔT cooking	Cooking program in which the oven temperature increases according to the core temperature. Not possible in conjunction with the superheated steam cooking program.
	Semi-automatic cleaning	Starts semiautomatic cleaning
	CONVOclean system	Starts fully automatic cleaning
	Overnight cooking	Opens the Overnight Cooking submenu.
	Reduced fan speed (optional)	Reduces the air-flow speed inside the oven.
	Reduced power	Reduces the power consumption, e.g. to cut peak power levels. May prolong the cooking time.
	Beep signal	Outputs an audible signal to remind the operator to perform a required action. Can only be included in recipes.
	Keypad lock	Blocks use of buttons in the control panel.
	Program protection	Prevents an energy optimization system affecting the program.
	Tray Timer (additional timer)	Sets a specific cooking time for each shelf. Can only be selected during cooking operation.
	Manual steaming	Adds moisture manually during cooking. Can only be selected during cooking using convection or superheated steam. Cannot be included in a recipe.
	Cook & Hold	2-stage program that adds a finishing (holding) phase to the cooking phase. Can only be included in recipes.
	Default settings	Opens the Default Settings submenu.

The Crisp&Tasty submenu

The icons in the Crisp&Tasty submenu have the following meanings and functions:

Icon	Meaning	Function
	Low moisture removal	Crisp&Tasty level; specifying the amount of excess moisture removed from the oven.
	Medium moisture removal	Not possible in conjunction with the Steam cooking program.
	Strong moisture removal	



The Cleaning submenu

The references used in the Cleaning submenu have the following meanings and functions:

Name	Meaning	Function
Q	Quick clean	Starts the quick-clean cycle.
1	Cleaning level 1: light soiling	Starts fully automatic cleaning.
2	Cleaning level 2: moderate soiling	Starts fully automatic cleaning.
3	Cleaning level 3: Heavy soiling	Starts fully automatic cleaning.
4	Cleaning level 4: Heavy soiling with Shine+	Starts fully automatic cleaning.











The Overnight Cooking submenu

The icons in the Overnight cooking submenu have the following meanings and functions:

Icon	Meaning	Function
	Medium	Multi-step slow program for preserving the quality when roasting large joints.
	Well done	
	Boiling	

The Default settings submenu

The icons in the Default settings submenu have the following meanings and functions:

Icon	Meaning	Function
	Beep signal	Selects the beep signal.
	Volume	Sets the volume
	time	Sets the time.
	date	Sets the date.
	Sorts the cookbook	Selects the recipe sorting option for the cookbook: <ul style="list-style-type: none"> ▪ Alphabetical ▪ Numerical based on the memory-location number
	Expert default values or last-used values	Selects Expert default values or last-used values
	Temperature display	Selects °C or °F.
	Network address	Sets the network address.
	Saving the cookbook	Saves your cookbook on an ID module (IDM).
	Loading the cookbook	Loads your cookbook from an ID module (IDM).
	Language	Sets the language of the user interface

► The Cookbook menu

The Cookbook menu

The icons in the Cookbook menu are shown in the display. The Cookbook menu can be opened using the following buttons:



The icons and what they do

The icons in the Cookbook menu have the following meanings and functions:

Icon	Meaning	Function
	New recipe	Creates a new recipe.
	Edit recipe	Opens the submenu for editing a recipe.
	Delete recipe	Deletes a recipe.
	Copy recipe	Copies a recipe.

The submenu for editing a recipe

The submenu for editing a recipe can be opened using the following buttons:



The icons in the submenu for editing a recipe have the following meanings and functions:

Icon	Meaning	Function
	Insert step	Inserts a new recipe step.
	Append step	Appends an extra recipe step.
	Delete step	Deletes a recipe step.

▶ The Write/Edit menu



The Write/Edit menu

The icons in the Write/Edit menu are shown in the display. The Write/Edit menu can be opened using the following button:



The icons and what they do

The icons in the Write/Edit menu have the following meanings and functions:

Icon	Meaning	Function
	New recipe	Creates a new recipe.
	Recording	Records changes in cooking program, temperature and time in up to 20 cooking steps.
	Transfer	Transfers to the cookbook the last recipe you created or recorded.

5 How to operate the control panel

Operating your combi steamer

This chapter contains step-by-step instructions for basic operations using the combi steamer. We show you how to switch the combi steamer on and off, the easy way to make your first cooked products, and the correct procedure to follow when cooking.

Contents

This chapter contains the following sections:

	Page
First operating steps	60
Cooking and regenerating	65
Working with the cookbook	100
Adjusting the default settings	113

5.1 First operating steps

First operating steps

This section shows you how to switch the combi steamer on and off, and the easy way to make your first cooked products.

Contents





This section contains the following topics:

	Page
Turning the combi steamer on and off	61
Cooking with Press&Go (optional)	63

▶ Turning the combi steamer on and off

Switching on the combi steamer

To switch on the combi steamer, follow the steps below:

Step	Action	Illustration
1	Switch on the combi steamer. Result: <ul style="list-style-type: none"> ▪ for OEB/OGB appliances whatever the cooking program: If the date has changed, the display contains a prompt to rinse out the steam generator. ▪ always: <ul style="list-style-type: none"> ▪ Self-test performed ▪ The oven light will turn on. 	
2	For OEB/OGB appliances , use the tilt selector switch to choose "Turn off steam-generator rinsing" and confirm with the "Functions menu" button.	
3	Select your cooking program.	
4	Start the cooking program. Result: <ul style="list-style-type: none"> ▪ for OES/OGS appliances whatever the cooking program, and for all other appliances for the convection program: The selected cooking program will start immediately. ▪ in specific cases: If it is an OEB or OGB appliance and you have started one of the "steam", "superheated steam" or "regenerate" cooking programs, the steam generator is first filled and heated automatically. As soon as this process is completed, the selected cooking program begins for the cooking time set in the program. 	

Switching off the combi steamer at the end of the working day

To switch off the combi steamer at the end of the working day, follow the steps below:

Step	Action	Button
1	Perform the necessary cleaning tasks as specified in the cleaning and maintenance schedule.	
2	Switch off the combi steamer. Result: The combi steamer is in standby mode and displays just the date and time.	

Switching off the combi steamer before prolonged breaks in use

Switch off the water and power on site before prolonged breaks in use.

More on this ...

Related topics

<input type="checkbox"/> Emptying and rinsing the steam generator	158
<input type="checkbox"/> Basic working procedure for cooking	67
<input type="checkbox"/> Basic working procedure for regenerating	67

▶ Cooking with Press&Go (optional)

Hot steam / vapor

▲WARNING

Risk of scalding from hot steam and vapor

Escaping hot steam and vapor can cause scalding to face, hands, feet and legs.

- ▶ Open the appliance door as specified in the user manual. Never put your head into the oven!
- ▶ For floor-standing appliances, insert the preheat bridge if there is no loading trolley in the combi steamer during preheating.

Objective

You wish to start a recipe directly.



Requirements

Check that the following requirements have been met:

- The combi steamer is cleaned properly.
- The suction panel is properly locked in place.
- For table-top appliances: the rack or shelf rack is fixed in place.
- For floor-standing appliances: the preheat bridge is fitted.
- You are already conversant with the operating steps listed under "How to do it correctly".

Cooking

To cook, follow the steps below:

Step	Action	Button
1	Preheat your combi steamer.	
2	Remove the preheat bridge from floor-standing appliances.	
3	Place the food inside the oven as soon as preheating has finished.	
4	Select the recipe (Press&Go) you want, such as Rolls.	
5	Close the appliance door. Result: <ul style="list-style-type: none">▪ Your recipe starts running.▪ An audible signal is given as soon as the recipe is finished.	
6	Open the appliance door and remove the finished product.	

Canceling programs before they have finished

To cancel programs before they have finished, follow the steps below:

Step	Action	Button
1	Press the "Start/Stop" button.	

More on this ...

How to do it

- Selecting the preheat option81

How to do it correctly

- Opening the appliance door safely 165
 - Inserting and removing the preheat bridge (floor-standing appliances only)..... 167
 - Removing and fitting the racks (table-top appliances only) 169
 - Loading table-top appliances / removing food from table-top appliances..... 170
 - Loading table-top appliances using the transport trolley..... 172
 - Loading floor-standing appliances 176
 - Removing and fitting the suction panel on table-top appliances..... 180
 - Stowing away the core temperature sensor for floor-standing appliances 179
-

5.2 Cooking and regenerating

Cooking in detail

This section shows you what steps you need to follow for cooking and regenerating, and how to use all the control panel functions for cooking.

Contents

This section contains the following topics:

	Page
Basic procedures	66
Entering the cooking data	69
Selecting extra functions and special programs	77
Performing cooking and regenerating	92

5.2.1 Basic procedures

Basic principles of operation

This section shows you how the basic steps for operating your combi steamer.

Contents

This section contains the following topics:

	Page
Basic working procedure for cooking	67
Basic working procedure for regenerating	67
Basic working procedure in emergency mode	68

▶ Basic working procedure for cooking

How to do it

Using the combi steamer for cooking is very simple and only involves these 6 steps:

Step	Action	How to do it:
1	Switch on the combi steamer.	<i>Turning the combi steamer on and off on page 61</i>
2	Preheat your combi steamer if required.	<i>Selecting the preheat option on page 81</i>
3	Select or enter your cooking program.	<i>Retrieving a recipe from the cookbook on page 101</i> <i>Entering a cooking program on page 71</i>
4	Place the food in the combi steamer and start the cooking program.	<i>Cooking as part of the daily routine on page 93</i>
5	You can use various extra functions during the cooking program.	<i>Manual steaming during cooking on page 97</i> <i>Using Tray Timer (additional timer) during cooking on page 98</i>
6	Remove the finished product.	

▶ Basic working procedure for regenerating

How to do it

Using the combi steamer for regenerating is very simple and only involves these 6 steps:

Step	Action	How to do it:
1	Switch on the combi steamer.	<i>Turning the combi steamer on and off on page 61</i>
2	Preheat your combi steamer if required.	<i>Selecting the preheat option on page 81</i>
3	Select or enter your regenerating program.	<i>Entering the regenerating program on page 72</i>
4	Place the food in the combi steamer and start the regenerating program.	<i>Regenerating as part of the daily routine on page 95</i>
5	You can use various extra functions during the regenerating program.	<i>Using Tray Timer (additional timer) during cooking on page 98</i>
6	Remove the finished product.	

▶ Basic working procedure in emergency mode

Limitations

You need to note the following limitations:

- The cooking times may change significantly. So pay particular attention to the cooking process and the cooked condition of your product.
- The water consumption may rise significantly.
- Not all functions can be selected.

How to do it

Using the combi steamer for cooking in emergency mode is very simple and only involves these 5 steps:

Step	Action	How to do it:
1	The appliance is on fault mode. Result: A signal sounds and the error code is shown in the display.	<i>Troubleshooting</i> on page 161 Contact customer service
2	Press the "Start / Stop" button. Result: Only those cooking programs unaffected by the error are available.	
3	Place the food in the combi steamer and start the cooking program or regenerating program.	<i>Cooking as part of the daily routine</i> on page 93 <i>Regenerating as part of the daily routine</i> on page 95
4	You can use various extra functions while the available cooking program or regenerating program is running.	
5	Remove the finished product.	

5.2.2 Entering the cooking data

Basic principles of operation

This section shows you how the basic steps for operating your combi steamer.

Contents





This section contains the following topics:

	Page
Basic procedure for entering the cooking data	70
Entering a cooking program	71
Entering the regenerating program	72
Entering a multi-step cooking or regenerating program	73
Setting the start-time preset	75

▶ Basic procedure for entering the cooking data

Entering the cooking data







To enter your cooking temperature, cooking time or core temperature, follow the steps below:

Step	Action	Button
1	Press the "Oven temperature", "Cooking time" or "Core temperature" button. Result: The display shows the values to be set.	 or  or 
2	Use the tilt selector switch to set the desired value. Result: <ul style="list-style-type: none">▪ Your value is entered.▪ You do not need to confirm the value you have entered.	

▶ Entering a cooking program

Entering a cooking program

To enter a cooking program, follow the steps below:

Step	Action	Button
1	Select a main cooking program.	
2	Enter the cooking temperature.	
3	Define the switch-off criteria: <ul style="list-style-type: none"> ▪ Cooking time or ▪ Core temperature (optional for OES and OGS) 	 or 
4	Press the "Functions menu" button to select an extra function or a special cooking program.	
5	Select one of the following extra functions if required: <ul style="list-style-type: none"> ▪ Start-time preset ▪ Crisp&Tasty ▪ Reduced power ▪ Lower fan speed ▪ Program protection ▪ Preheating ▪ ΔT cooking ▪ Overnight cooking <p>Result: You have now finished entering your cooking program, which is held in the temporary memory.</p>	

Saving a cooking program

When entering a cooking program, the program is saved in a temporary memory. Whenever a new program is entered, it overwrites this temporary memory and wipes the original cooking program. If you wish to use a cooking program again later, you can transfer it to the cookbook as a recipe.

More on this ...

How to do it

Selecting extra functions and special programs77









Next steps

Cooking as part of the daily routine.....93

▶ Entering the regenerating program

Entering the regenerating program

To enter your regenerating program, follow the steps below:

Step	Action	Button
1	Select a regenerating program.	
2	Enter the regenerating temperature.	
3	Define the switch-off criteria: ▪ Cooking time or ▪ Core temperature	 or 
4	Press the "Functions menu" button to select an extra function.	
5	Select one of the following extra functions if required: ▪ Tray Timer ▪ Reduced power ▪ Lower fan speed ▪ Program protection Result: You have now finished entering your regenerating program, which is held in the temporary memory.	   

Saving a cooking program

When entering a cooking program, the program is saved in a temporary memory. Whenever a new program is entered, it overwrites this temporary memory and wipes the original cooking program. If you wish to use a cooking program again later, you can transfer it to the cookbook as a recipe.

More on this ...

How to do it

Selecting extra functions and special programs77



Next steps

Regenerating as part of the daily routine95

▶ Entering a multi-step cooking or regenerating program

Entering a multi-step cooking or regenerating program

To create a multi-step cooking program, follow the steps below:

Step	Action	Button
1	<p>Press and hold the required cooking program or regenerating program for 3 seconds.</p> <p>Result: The display shows the following items</p> <ul style="list-style-type: none"> ▪ top: 01/01 for the first cooking step ▪ bottom: the time and temperature values 	
2	<p>Enter the cooking step. To do this, follow the instructions for entering a cooking program.</p> <p>Result: Once you have entered the extra functions, you have finished entering step 1 of your cooking program.</p>	
3	<p>Press and hold the required cooking program or regenerating program for 3 seconds.</p> <p>Result: The display shows the following items</p> <ul style="list-style-type: none"> ▪ top: 02/02 for the second cooking step ▪ bottom: the time and temperature values 	
4	<p>Enter the cooking step. In this cooking step you can select the Cook&Hold program if you wish.</p> <p>Result: Once you have entered the extra functions, you have finished entering step 2 of your cooking program.</p>	
5	<p>Enter further cooking steps by repeating steps 3 and 4. You can enter up to 20 cooking steps.</p> <p>Result: You have now finished entering your multi-step cooking program, which is held in the temporary memory.</p>	

Saving a cooking program

When entering a cooking program, the program is saved in a temporary memory. Whenever a new program is entered, it overwrites this temporary memory and wipes the original cooking program. If you wish to use a cooking program again later, you can transfer it to the cookbook as a recipe.

More on this ...

How to do it

<input type="checkbox"/> Entering a cooking program	71
<input type="checkbox"/> Setting Cook & Hold	83
<input type="checkbox"/> Including a beep signal in a cooking program.....	87

Next steps

<input type="checkbox"/> Cooking as part of the daily routine.....	93
<input type="checkbox"/> Regenerating as part of the daily routine	95

▶ Setting the start-time preset

Objective

You wish to use the start-time preset to specify when the combi steamer will automatically start the required cooking or regenerating program. This helps you to avoid bottlenecks in production and preparation, and lets you make the most of low-usage periods.

Time settings for the start-time preset

The illustration below shows the adjustable time settings in the display:

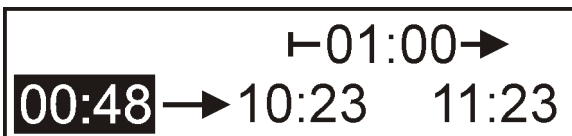







The time settings have the following meanings:

Position	Meaning	When value is displayed
top	Total cooking time: 01:00 hour	only in cooking-time mode
bottom left	The combi steamer starts in 48 minutes	in cooking-time and core-temperature mode (optional on OES and OGS)
bottom center	Start time: 10:23 am	in cooking-time and core-temperature mode (optional on OES and OGS)
bottom right	Cooking end time: 11:23 am	only in cooking-time mode

Setting the start-time preset

To enter the start-time preset, follow the steps below:

Step	Action	Button
1	Press and hold the "cooking time" button while operating the tilt selector switch. Result: The display shows the time settings for the start-time preset.	 
2	Press and hold the "cooking time" button while using the tilt selector switch to move the display cursor to the start-time position.	 
3	Release the "cooking time" button. Result: The combi steamer automatically switches to start-time preset mode.	
4	Press and hold the "cooking time" button while using the tilt selector switch to adjust the start time to the value you require. Result: The set cooking program starts automatically when the start time is reached.	 

Exiting the start-time preset mode

You can leave start-time preset mode at any time, but the start-time preset will be deleted.

To exit start-time preset mode, follow the steps below:

Step	Action	Button
1	Press the "Start/Stop" button.	

Entering the end of cooking time instead of the start time

In cooking-time mode you can enter the end of cooking time instead of the start time.

More on this ...

Next steps

- Cooking as part of the daily routine.....93
 - Regenerating as part of the daily routine95
-

5.2.3 Selecting extra functions and special programs

Basic principles of operation

This section shows you how the basic steps for operating your combi steamer.

Contents

This section contains the following topics:

	Page
Basic procedure for selecting extra functions and special programs	78
Selecting Crisp&Tasty (moisture removal)	80
Selecting the preheat option	81
Setting Delta-T cooking	82
Setting Cook & Hold	83
Entering a reduced power (optional for OES)	84
Specifying a reduced fan speed (optional for OES and OGS)	85
Setting program protection (only for OEB and OES)	86
Including a beep signal in a cooking program	87
Setting overnight cooking	88
Applying the keypad lock	89

▶ Basic procedure for selecting extra functions and special programs

Objective





You wish to select an extra function or a special program to go with the chosen cooking program.

Restriction

Only those extra functions and special programs that are logical to use with the selected cooking program are available and displayed as icons.

Basic procedure for selecting extra functions and special programs

Follow the steps below to select an extra function or a special program:

Step	Action	Button
1	Press the "Functions menu" button. Result: The display shows the function icons.	
2	Use the tilt selector switch to choose an extra function or a special program.	
3	Press the "Functions menu" button to confirm. Result: The Confirm menu appears in the display.	
4	Use the tilt selector switch to choose "YES".	 YES
5	Press the "Functions menu" button to confirm. Result: The extra function or special program is enabled.	

Rules relating to extra functions

The following rules apply to the use of extra functions:

- You can enable or disable the extra functions at any time during cooking operation by pressing the "Functions menu" button.
- You can combine extra functions in any way.
- When the cooking program has finished, your combi steamer automatically resets the selected extra function (except for the keypad lock) back to the default setting.

These rules do not apply to the following special programs:

- Preheating
- ΔT cooking
- Cook & Hold
- Overnight cooking

Closing the Functions menu

You can exit the Functions menu whenever you wish.

To exit the functions menu, follow the steps below:

Step	Action	Button
1	Press the "Start/Stop" button.	

▶ Selecting Crisp&Tasty (moisture removal)

Objective

You wish to remove excess moisture from an item of food.











Requirements

To do this, the following requirements must be satisfied:

- You have selected one of the "superheated steam" or "convection" programs.
- You are in the Functions menu.

Selecting Crisp&Tasty (moisture removal)

Follow the steps below to work with the Crisp&Tasty function:

Step	Action	Button
1	Use the tilt selector switch to choose the "Crisp&Tasty" icon.	 
2	Press the "Functions menu" button to confirm. Result: The Confirm menu appears in the display.	
3	Use the tilt selector switch to choose "YES".	 YES
4	Press the "Functions menu" button to confirm. Result: A selection menu appears in the display.	
5	Use the tilt selector switch to choose the degree of moisture removal: low, moderate or high	   
6	Press the "Functions menu" button to confirm. Result: ▪ The Crisp&Tasty extra function is enabled. ▪ The function indicator lights up.	 

More on this ...

How to do it

- Basic procedure for selecting extra functions and special programs.....78
-

▶ Selecting the preheat option

Objective

For optimum production reliability, you can preheat your combi steamer for dish production.







Requirements

To do this, the following requirements must be satisfied:

- You are in the Functions menu.

Selecting the preheat option

Follow the steps below to preheat your combi steamer:

Step	Action	Button
1	Use the tilt selector switch to choose the "Preheat" icon.	
2	Press the "Functions menu" button to confirm. Result: The Confirm menu appears in the display.	
3	Use the tilt selector switch to choose "YES".	 YES
4	Press the "Functions menu" button to confirm. Result: The combi steamer starts the preheat program using the following factory setting: ▪ Cooking temperature: 190°C ▪ Cooking time: 10min The "Preheat" icon appears in the display.	 
5	Press the "Cooking temperature" button and set a different preheat temperature.	
6	Press the "Cooking time" button and set a different preheat time.	

More on this ...

How to do it

- Basic procedure for selecting extra functions and special programs.....78

▶ Setting Delta-T cooking

Objective

You wish to roast a large joint particularly carefully to preserve its quality.









Requirements

To do this, the following requirements must be satisfied:

- You have a core temperature sensor.
- You have selected one of the "steam" or "convection" programs.
- You are in the Functions menu.

Setting Delta-T cooking

Follow the steps below to specify ΔT cooking:

Step	Action	Button
1	Use the tilt selector switch to choose the " ΔT cooking" icon.	 ΔT
2	Press the "Functions menu" button to confirm. Result: The Confirm menu appears in the display.	
3	Use the tilt selector switch to choose "YES".	 YES
4	Press the "Functions menu" button to confirm.	
5	Press the "Cooking temperature" button.	
6	Use the tilt selector switch to set the ΔT temperature you require.	 20°C
7	Press the "Core temperature" button.	
8	Use the tilt selector switch to set the final core temperature you require.	 75°C

More on this ...

How to do it

- Basic procedure for selecting extra functions and special programs.....78

▶ Setting Cook & Hold

Objective

Long before you need the finished dish, you can make use of periods of low activity to prepare food as usual.







Requirements

To do this, the following requirements must be satisfied:

- You have a core temperature sensor.
- You are in the process of entering a multi-step cooking program.
- You have reached at least at the second cooking step.
- You have selected one of the cooking programs "steam", "superheated steam" or "convection".
- You are in the Functions menu.



Setting Cook & Hold

Follow the steps below to specify the Cook & Hold option:

Step	Action	Button
1	Use the tilt selector switch to choose the "Cook & Hold" icon.	 cook & hold
2	Press the "Functions menu" button to confirm. Result: The Confirm menu appears in the display.	
3	Use the tilt selector switch to choose "YES".	 YES
4	Press the "Functions menu" button to confirm.	
5	Press the "Cooking temperature" button.	
6	Use the tilt selector switch to set the Hold temperature you require.	 65°C
7	Continue entering the recipe or start the recipe.	

Final step for saving the Cook & Hold information entered

Depending on where you started from, you will need to use different buttons to complete the input procedure and save the Cook & Hold function:

Objective	Button
To save the input in the temporary memory	
To save the input as part of a recipe you are creating	

More on this ...

How to do it

- Basic procedure for selecting extra functions and special programs.....78
 - Entering a multi-step cooking or regenerating program.....73
-

▶ Entering a reduced power (optional for OES)

Objective

To cut power consumption and to reduce peak power levels in the kitchen, you can set your combi steamer to run at reduced power. Use the reduced power option for insensitive products such as large roast joints and for small quantities of food in the oven.

Limitations







Please note that by reducing the power, food may take longer to cook.

Requirements

- To do this, the following requirements must be satisfied:
- You are in the Functions menu.

Entering a reduced power (optional for OES)

Follow the steps below to work with the reduced power option:

Step	Action	Button
1	Use the tilt selector switch to choose the "Reduced power" icon.	 
2	Press the "Functions menu" button to confirm. Result: The Confirm menu appears in the display.	
3	Use the tilt selector switch to choose "YES".	 YES
4	Press the "Functions menu" button to confirm. Result: ▪ The "Reduced power" extra function is enabled. ▪ The function indicator lights up.	 

More on this ...

How to do it

- Basic procedure for selecting extra functions and special programs.....78
-

► Specifying a reduced fan speed (optional for OES and OGS)

Objective







By reducing the fan speed you cut the air-flow rate inside the oven. Use the reduced fan speed for products that are sensitive to air flow, such as soufflés, meringues, sponges, puffs or flaky pastries.

Requirements

- To do this, the following requirements must be satisfied:
- You are in the Functions menu.

Specifying a reduced fan speed (optional for OES and OGS)

Follow the steps below to work with the reduced fan speed:

Step	Action	Button
1	Use the tilt selector switch to choose the "Reduced fan speed" icon.	 
2	Press the "Functions menu" button to confirm. Result: The Confirm menu appears in the display.	
3	Use the tilt selector switch to choose "YES".	 YES
4	Press the "Functions menu" button to confirm. Result: <ul style="list-style-type: none"> ▪ The "Reduced fan speed" extra function is enabled. ▪ The function indicator lights up. 	 

More on this ...

How to do it

- Basic procedure for selecting extra functions and special programs.....78

▶ Setting program protection (only for OEB and OES)

Objective

If the combi steamer is connected to an energy optimization system, then this system may interrupt the power supply to the appliance during peak power periods. Sometimes this may also happen during critical phases of a cooking process. Inhibit energy optimization if the quality of the dishes depends on the preset cooking programs running exactly as specified.

Program protection automatically prevents any interruption of cooking programs that are running. Within recipes, you can protect individual cooking steps with the program protection option.







Requirements

To do this, the following requirements must be satisfied:

- You have a compatible energy optimization system fitted in your premises that is connected to your appliance.
- You are in the Functions menu.

Setting program protection (only for OEB and OES)

Follow the steps below to work with program protection:

Step	Action	Button
1	Use the tilt selector switch to choose the "Program protection" icon.	 
2	Press the "Functions menu" button to confirm. Result: The Confirm menu appears in the display.	
3	Use the tilt selector switch to choose "YES".	 YES
4	Press the "Functions menu" button to confirm. Result: <ul style="list-style-type: none"> ▪ The "Program protection" extra function is enabled. ▪ The function indicator lights up. 	 

More on this ...

How to do it

- Basic procedure for selecting extra functions and special programs.....78

▶ Including a beep signal in a cooking program

Objective

To be reminded to perform an action, such as adding liquid, at the end of a cooking program, you can include a beep signal in the recipe.

After the beep sounds, you can then open the oven door and perform the required action. When you re-close the oven door, the recipe continues with the next cooking step.





Requirements

To do this, the following requirements must be satisfied:

- You are in the process of entering a multi-step cooking program.
- You are in the Functions menu.



Including a beep signal in a cooking program

Follow the steps below to include a beep signal:

Step	Action	Button
1	Use the tilt selector switch to choose the "beep signal" icon.	
2	Press the "Functions menu" button to confirm. Result: The Confirm menu appears in the display.	
3	Use the tilt selector switch to choose "YES".	
4	Press the "Functions menu" button to confirm.	
5	Continue entering the cooking program. Result: The beep signal sounds for 3 minutes after the end of a recipe step. The recipe continues to run while it sounds.	

Final step for saving the extra function of the beep signal

Depending on where you started from, you will need to use different buttons to complete the input procedure and save the extra function for the beep signal:

Objective	Button
To save the input in the temporary memory	
To save the input as part of a recipe you are creating	

More on this ...

How to do it

- Basic procedure for selecting extra functions and special programs.....78
 - Entering a multi-step cooking or regenerating program.....73
-

▶ Setting overnight cooking

Objective

Long before you need the finished dish, you can make use of periods of low activity to prepare food as usual, place it in the combi steamer and start Overnight cooking.











Requirements

To do this, the following requirements must be satisfied:

- You need the core temperature sensor.
- You are in the Functions menu.

Setting overnight cooking

Follow the steps below to specify overnight cooking:

Step	Action	Button
1	Use the tilt selector switch to choose the "Overnight cooking" icon.	 
2	Press the "Functions menu" button to confirm. Result: The Confirm menu appears in the display.	
3	Use the tilt selector switch to choose "YES".	 YES
4	Press the "Functions menu" button to confirm. Result: A selection menu appears in the display.	
5	Use the tilt selector switch to choose the overnight cooking program: medium, well-done or boil	   
6	Press the "Functions menu" button to confirm. Result: The program starts running.	

More on this ...

How to do it

- Basic procedure for selecting extra functions and special programs.....78
-

▶ Applying the keypad lock





Objective

You can block the use of almost all the controls on your combi steamer. You can use this lock to prevent unauthorized people from changing settings on your combi steamer.

You need to enter a PIN code to apply the lock.

Limitations

You cannot block use of the following controls:

Control	Button
On / Off	
Start / Stop	
"Next" and "Back"	
Tilt selector switch	
Press&Go buttons	

Preset PIN code and changing the PIN code

The PIN code "PIN 001" is preset in the factory. Please contact an approved customer service engineer if you wish to change the PIN code.





Requirements





To do this, the following requirements must be satisfied:

- The combi steamer is not running.
- You are in the Functions menu.

Locking









Follow the steps below to lock the buttons on your combi steamer:

Step	Action	Button
1	Use the tilt selector switch to choose the "Keypad lock" icon.	
2	Press the "Functions menu" button to confirm. Result: The Confirm menu appears in the display.	
3	Use the tilt selector switch to choose "YES".	
4	Press the "Functions menu" button to confirm. Result: "PIN 000" appears in the display.	

Step	Action	Button
5	Use the tilt selector switch to choose the PIN code.	 001
6	Press the "Functions menu" button to confirm. Result: "all keys unlocked" appears in the display.	
7	Press each button to be locked in turn. Result: The display shows "key locked".	
8	Press the "Start / Stop" button. Result: <ul style="list-style-type: none"> ▪ The keypad lock is enabled. ▪ The function indicator lights up. 	 



Unlocking

Follow the steps below to unlock the buttons on your combi steamer:

Step	Action	Button
1	Use the tilt selector switch to choose the "Keypad lock" icon.	 
2	Press the "Functions menu" button to confirm. Result: The Confirm menu appears in the display.	
3	Use the tilt selector switch to choose "YES".	 YES
4	Press the "Functions menu" button to confirm. Result: "PIN 000" appears in the display.	
5	Use the tilt selector switch to choose the PIN code.	 001
6	Press the "Functions menu" button to confirm. Result: <ul style="list-style-type: none"> ▪ All buttons are unlocked. ▪ The function indicator is no longer illuminated. 	 
7	Press the "Start/Stop" button to exit the Functions menu.	

Entering the PIN code when the Functions menu is locked

Follow the steps below to unlock the buttons on your combi steamer:

Step	Action	Button
1	Switch off your combi steamer using the "On/Off" button. Result: The time and date appear in the display.	
2	Press the "Functions menu" button. Result: "PIN 000" appears in the display.	
3	Use the tilt selector switch to choose the PIN code. Result: All buttons are unlocked.	 001

More on this

How to do it

- Basic procedure for selecting extra functions and special programs.....78
-

5.2.4 Performing cooking and regenerating

Basic principles of operation

This section shows you how the basic steps for operating your combi steamer.

Contents

This section contains the following topics:

	Page
Cooking as part of the daily routine	93
Regenerating as part of the daily routine	95
Manual steaming during cooking and regenerating	97
Using Tray Timer (additional timer) during cooking and regenerating	98

▶ Cooking as part of the daily routine

Hot steam / vapor

▲WARNING

Risk of scalding from hot steam and vapor

Escaping hot steam and vapor can cause scalding to face, hands, feet and legs.

- ▶ Open the appliance door as specified in the safety regulations. Never put your head into the oven!

Contamination hazard

▲WARNING

Risk from microbiological contamination of food

When loading the oven ahead of time, e.g. for pre-setting the start time of the cooking program, the cold chain of chilled foodstuffs may be broken.

- ▶ When planning the loading times, always ensure there is no break in the cold chain.





Requirements

Check that the following requirements have been met:

- The combi steamer is cleaned properly.
- The suction panel is properly locked in place.
- For table-top appliances: the rack or shelf rack is fixed in place.
- You are already conversant with the operating steps listed under "How to do it correctly".

Boiling

To cook, follow the steps below:

Step	Action	Button
1	Preheat your combi steamer if required.	
2	Enter the cooking program you require or retrieve it from the cookbook. Result: A cooking program is available.	
3	Load the oven.	
4	Start the cooking program. Result: The cooking program starts running. The function indicator lights up. An audible signal is given as soon as the cooking program is finished.	 
5	Open the appliance door and remove the cooked product.	

Start the cooking program later

You can use the start-time preset to start the cooking program at a later time.

Canceling programs before they have finished

To cancel programs before they have finished, follow the steps below:

Step	Action	Button
1	Press the "Start/Stop" button.	

What you can do while the program is running

You can perform the following actions while the program is running:

- You cannot change the cooking parameters. Press the "Cooking temperature", "Cooking time" or "Core temperature" buttons and correct the values.
- You can retrieve the cooking parameters. To display the actual oven temperature, the required cooking time and the required core temperature, press the relevant button one or two times.

You can get your approved customer service engineer to set up a beeping signal that sounds when the appliance door is opened during the program. This will ensure the door cannot be opened without you knowing.

More on this ...

How to do it

<input type="checkbox"/> Entering a cooking program	71
<input type="checkbox"/> Retrieving a recipe from the cookbook	101
<input type="checkbox"/> Entering a multi-step cooking or regenerating program.....	73
<input type="checkbox"/> Setting the start-time preset	75

Next steps

<input type="checkbox"/> Using Tray Timer (additional timer) during cooking and regenerating	98
<input type="checkbox"/> Manual steaming during cooking and regenerating	97

How to do it correctly

<input type="checkbox"/> Opening the appliance door safely	165
<input type="checkbox"/> Inserting and removing the preheat bridge (floor-standing appliances only)	167
<input type="checkbox"/> Removing and fitting the racks (table-top appliances only)	169
<input type="checkbox"/> Loading table-top appliances / removing food from table-top appliances.....	170
<input type="checkbox"/> Loading table-top appliances using the transport trolley.....	172
<input type="checkbox"/> Loading floor-standing appliances	176
<input type="checkbox"/> Removing and fitting the suction panel on table-top appliances.....	180

▶ Regenerating as part of the daily routine

Hot steam / vapor

▲WARNING

Risk of scalding from hot steam and vapor

Escaping hot steam and vapor can cause scalding to face, hands, feet and legs.

- ▶ Open the appliance door as specified in the safety regulations. Never put your head into the oven!

Contamination hazard

▲WARNING

Risk from microbiological contamination of food

When loading the oven ahead of time, e.g. for pre-setting the start time of the cooking program, the cold chain of chilled foodstuffs may be broken.

- ▶ When planning the loading times, always ensure there is no break in the cold chain.





Requirements

Check that the following requirements have been met:

- The combi steamer is cleaned properly.
- The suction panel is properly locked in place.
- For table-top appliances: the rack or shelf rack is fixed in place.
- You are already conversant with the operating steps listed under "How to do it correctly".

Boiling

To cook, follow the steps below:

Step	Action	Button
1	Preheat your combi steamer if required.	
2	Enter the regenerating program you require or retrieve it from the cookbook. Result: A regenerating program is available.	
3	Load the oven.	
4	Start the regenerating program. Result: The regenerating program starts running. The function indicator lights up. An audible signal is given as soon as the regenerating program is finished.	 
5	Open the appliance door and remove the cooked product.	

Start the cooking program later

You can use the start-time preset to start the regenerating program at a later time.

Canceling programs before they have finished

To cancel programs before they have finished, follow the steps below:

Step	Action	Button
1	Press the "Start/Stop" button.	

What you can do while the program is running

You can perform the following actions while the program is running:

- You cannot change the cooking parameters. Press the "Cooking temperature", "Cooking time" or "Core temperature" buttons and correct the values.
- You can retrieve the cooking parameters. To display the actual oven temperature, the required cooking time and the required core temperature, press the relevant button one or two times.

You can get your approved customer service engineer to set up a beeping signal that sounds when the appliance door is opened during the program. This will ensure the door cannot be opened without you knowing.

More on this ...

How to do it

<input type="checkbox"/> Retrieving a recipe from the cookbook	101
<input type="checkbox"/> Entering a multi-step cooking or regenerating program.....	73
<input type="checkbox"/> Entering the regenerating program	72
<input type="checkbox"/> Setting the start-time preset	75

Next steps

<input type="checkbox"/> Using Tray Timer (additional timer) during cooking and regenerating	98
--	----

How to do it correctly

<input type="checkbox"/> Opening the appliance door safely	165
<input type="checkbox"/> Inserting and removing the preheat bridge (floor-standing appliances only).....	167
<input type="checkbox"/> Removing and fitting the racks (table-top appliances only)	169
<input type="checkbox"/> Loading table-top appliances / removing food from table-top appliances.....	170
<input type="checkbox"/> Loading table-top appliances using the transport trolley.....	172
<input type="checkbox"/> Loading floor-standing appliances	176
<input type="checkbox"/> Removing and fitting the suction panel on table-top appliances.....	180

▶ Manual steaming during cooking and regenerating

Objective

You wish to provide extra steaming of the food during a "superheated steam" or "convection" cooking program that is already in progress.





Requirements

To do this, the following requirements must be satisfied:

- You have selected one of the "superheated steam" or "convection" programs.
- One of these programs is running.
- You are in the Functions menu.

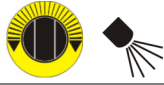
Manual steaming during cooking

Follow the steps below to steam the food during cooking:

Step	Action	Button
1	Use the tilt selector switch to choose the "manual steaming" icon.	
2	Press the "Functions menu" button to confirm. Result: The Confirm menu appears in the display.	
3	Use the tilt selector switch to choose "YES"	 YES
4	Press the "Functions menu" button to confirm. Result: The food is steamed for 10 seconds.	

More on this ...

How to do it

- Basic procedure for selecting extra functions and special programs.....78
-

▶ Using Tray Timer (additional timer) during cooking and regenerating

Hot steam / vapor

⚠WARNING

Risk of scalding from hot steam and vapor

Escaping hot steam and vapor can cause scalding to face, hands, feet and legs.

- ▶ Open the appliance door as specified in the safety regulations. Never put your head into the oven!

Objective

You wish to use spare shelves to cook other food during a cooking program that is already in progress.







Requirements

To do this, the following requirements must be satisfied:

- Apart from the cooking time, the additional food to be cooked needs the same conditions as the food in the current program that is running.
- The relevant cooking program is running.
- You are in the Functions menu.

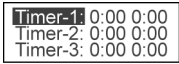
Using Tray Timer (additional timer) during cooking and regenerating

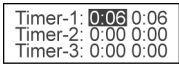
Follow the steps below to work with the additional timer:

Step	Action	Button
1	Use the tilt selector switch to choose the "Tray Timer (additional timer)" icon.	
2	Press the "Functions menu" button to confirm. Result: The display shows the specified time and remaining time for the Tray Timer:	 
3	Use the "Next" button to switch to the specified time, and use the tilt selector switch to adjust the cooking time for this timer. Result: The selected timer starts running as soon as you enter a time greater than 0:00.	  
4	Press the "Functions menu" button or the "Start/Stop" button to exit the Timer function.	 or 
5	Place the food in the oven and close the oven door. Result: As soon as the additional timer has timed out, "Timer xy" is displayed and a signal sounds.	
6	Open the appliance door and remove the cooked product from this shelf. Please note: ▪ Resetting a timer to 0:00 stops the timer function. ▪ Please also note that the selected cooking program continues to run even after the signal sounds.	

More on this ...

How to do it

- Basic procedure for selecting extra functions and special programs.....78
-

5.3 Working with the cookbook

The combi steamer cookbook

This section shows you how to create, edit and manage recipes in the cookbook.

Contents

This section contains the following topics:

	Page
Retrieving a recipe from the cookbook	101
Creating a cooking recipe	102
Recording a cooking program	103
Transferring a recipe to the cookbook	105
Editing, deleting and copying recipes	106
Inserting, appending and deleting cooking steps	108
Working with Press&Go	111



▶ Retrieving a recipe from the cookbook

Objective

You wish to retrieve one of the saved recipes from the cookbook.

Retrieving a recipe from the saved recipes

To retrieve a recipe from the recipes saved in the cookbook, follow the steps below:

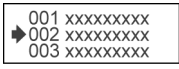
Step	Action	Button
1	Press the "Cookbook menu" button. Result: A list of saved recipes appears in the display.	
2	Use the tilt selector switch to choose the recipe you require.	 

More on this ...

Next steps

- Cooking as part of the daily routine.....93
 - Regenerating as part of the daily routine95
-













▶ Creating a cooking recipe

Objective

You wish to create a new recipe. You can save up to 250 recipes in the cookbook.

Creating a cooking recipe

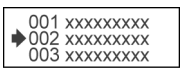
To create a cooking recipe, follow the steps below:

Step	Action	Button
1	Press the "Write/Edit menu" button. Result: The "Write/Edit menu" appears in the display.	
2	Use the tilt selector switch to choose the "New recipe" icon. Result: The cooking program buttons flash and 01/01 appears in the display.	 
3	Enter the single-step or multi-step cooking program you require, confirming each new cooking step with the "Write/Edit menu" button.	
4	To close the input process for the new cooking program, press the "Write/Edit menu" button when the cooking-program buttons are flashing. Result: You can now enter the name of the recipe.	
5	Use the tilt selector switch to select the letters, and the "Next" and "Back" buttons to switch between the respective placeholders.	  
6	Press the "Write/Edit menu" button to confirm the finished recipe name.	
7	Use the tilt selector switch to choose a spare memory location. Please note: You can also select and overwrite a memory location that is already occupied.	 
8	Press the "Write/Edit menu" button to confirm. Result: The recipe is saved in the cookbook.	

Closing the recipe

To exit the recipe, follow the steps below:

Step	Action	Button
1	Press the "Start/Stop" button.	

More on this ...

How to do it

□ Basic procedure for entering the cooking data	70
□ Entering a cooking program	71
□ Basic procedure for selecting extra functions and special programs.....	78

▶ Recording a cooking program

Objective

When recording a cooking program, you can save any changes made to the cooking program, temperature and timings in up to 20 cooking steps in the temporary memory. During the recording process, all the changes you make at the control panel during cooking are recorded, except for manual steaming and any cooking steps lasting less than one minute. You can press the "Start/Stop" button during the cooking process without your cooking steps being lost or overwritten.

To save permanently the cooking program you have created, you can transfer it to the cookbook as a recipe when you have finished recording it.





Recording procedure

Recording a cooking program involves 3 steps:

Step	Description
1	Start recorder.
2	Start the cooking/regenerating program.
3	Stopping the recorder





Starting the recorder

Follow the steps below to start the recorder:

Step	Action	Button
1	Press the "Write/Edit menu" button. Result: The "Write/Edit menu" appears in the display.	
2	To start the recording, use the tilt selector switch to choose the "Recording" icon.	 
3	Press the "Write/Edit menu" button to confirm. Result: <ul style="list-style-type: none"> ▪ The recorder starts recording until stopped. ▪ "Recorder ON" appears in the display ▪ The "Recording" icon appears in the display. 	 Recorder ON 

Stopping the recorder

Follow the steps below to stop the recorder:

Step	Action	Button
1	Press the "Write/Edit menu" button to stop the recording.	
2	Use the tilt selector switch to choose the "Recording" icon.	 
3	Press the "Write/Edit menu" button to confirm. Result: <ul style="list-style-type: none">▪ Recording is stopped.▪ "Recorder OFF" appears in the display▪ The "Recording" icon disappears from the display.	 Recorder OFF

More on this ...

Next steps

- Transferring a recipe to the cookbook..... 105
-

► Transferring a recipe to the cookbook

Objective











You can save particularly successful dishes in the cookbook. This lets you produce this dish time and time again with the same quality. You can use this facility to transfer to the cookbook the last recipe you created or recorded.

Requirements

- To do this, the following requirements must be satisfied:
- You have a cooking program in the temporary memory.

Transferring a cooking program to the cookbook as a recipe

Follow the steps below to transfer a cooking program to the cookbook as a recipe:

Step	Action	Button
1	Press the "Write/Edit menu" button. Result: The "Write/Edit menu" appears in the display.	
2	Use the tilt selector switch to choose the "Transfer" icon.	 
3	Press the "Write/Edit menu" button to confirm. Result: You can now enter the name of the recipe.	
4	Use the tilt selector switch to select the letters, and the "Next" and "Back" buttons to switch between the respective placeholders.	  
5	Press the "Write/Edit menu" button to confirm the finished recipe name.	
6	Use the tilt selector switch to choose a spare memory location. Please note: You can also select and overwrite a memory location that is already occupied.	 119
7	Press the "Write/Edit menu" button to confirm the selection. Result: The cooking program is saved in the cookbook as a recipe.	

▶ Editing, deleting and copying recipes

Objective





You wish to change the cooking steps in a recipe that has been created, or delete or copy a created recipe.

Requirements

- To do this, the following requirements must be satisfied:
- You have retrieved a recipe from the cookbook.



Editing a recipe

To edit a recipe, follow the steps below:

Step	Action	Button
1	Press the "Write/Edit menu" button. Result: The "Cookbook menu" appears in the display.	
2	Use the tilt selector switch to choose the "Edit recipe" icon.	
3	Press the "Write/Edit menu" button to confirm. Result: The individual cooking steps in the recipe are displayed.	
4	Use the "Next" and "Back" buttons to select the cooking step that you wish to change.	
5	Correct the recipe or change the cooking data.	
6	Press the "Write/Edit menu" button to confirm. Result: The recipe step is modified.	







Deleting a recipe

To delete a recipe, follow the steps below:

Step	Action	Button
1	Press the "Write/Edit menu" button. Result: The "Cookbook menu" appears in the display.	
2	Use the tilt selector switch to choose the "Delete recipe" icon.	
3	Press the "Write/Edit menu" button to confirm. Result: <ul style="list-style-type: none"> ▪ The recipe is deleted. ▪ The memory location number of the deleted recipe is now available again. 	

Copying a recipe

To copy a cooking recipe, follow the steps below:

Step	Action	Button
1	Press the "Write/Edit menu" button. Result: The "Cookbook menu" appears in the display.	
2	Use the tilt selector switch to choose the "Copy recipe" icon.	 
3	Press the "Write/Edit menu" button to confirm. Result: The memory locations are displayed.	
4	Use the tilt selector switch to choose a spare memory location. Please note: You can also select and overwrite a memory location that is already occupied.	 005
5	Press the "Write/Edit menu" button to confirm the selection. Result: The recipe is copied and saved in the cookbook.	

Closing the recipe

To exit the recipe, follow the steps below:

Step	Action	Button
1	Press the "Cookbook menu" button	

More on this ...

How to do it

- Retrieving a recipe from the cookbook 101

Next steps

- Basic procedure for entering the cooking data70
 - Entering a cooking program71
 - Basic procedure for selecting extra functions and special programs.....78
-

▶ Inserting, appending and deleting cooking steps

Objective

You wish to insert a cooking step in a saved recipe, append a cooking step to a saved recipe or delete a cooking step from a saved recipe.









Requirements

To do this, the following requirements must be satisfied:

- You have retrieved a recipe from the cookbook.
- The recipe contains less than 20 cooking steps.









Insert cooking step

To insert a cooking step in a recipe, follow the steps below:

Step	Action	Button
1	Press the "Write/Edit menu" button. Result: The "Cookbook menu" appears in the display.	
2	Use the tilt selector switch to choose the "Edit recipe" icon.	
3	Press the "Write/Edit menu" button to confirm. Result: The individual cooking steps in the recipe are displayed.	
4	Use the "Next" and "Back" buttons to select the cooking step in front of which you wish to insert a new cooking step.	
5	Press the "Functions menu" button to confirm. Result: The submenu for editing a recipe appears in the display.	
6	Use the tilt selector switch to choose the "Insert step" icon.	
7	Press the "Functions menu" button to confirm.	
8	Use the tilt selector switch to choose "YES".	
9	Press the "Functions menu" button to confirm. Result: <ul style="list-style-type: none"> ▪ A new cooking step is inserted at the selected point. ▪ All subsequent cooking steps are re-numbered. ▪ The new cooking step is highlighted and all cooking program buttons flash. 	
10	Now enter the cooking data for the new cooking step.	









Appending a cooking step

To append a cooking step to a recipe, follow the steps below:

Step	Action	Button
1	Press the "Write/Edit menu" button. Result: The "Cookbook menu" appears in the display.	
2	Use the tilt selector switch to choose the "Edit recipe" icon.	
3	Press the "Write/Edit menu" button to confirm. Result: The individual cooking steps in the recipe are displayed.	
4	Use the "Next" button to select the final cooking step.	
5	Press the "Functions menu" button to confirm. Result: The submenu for editing a recipe appears in the display.	
6	Use the tilt selector switch to choose the "Append step" icon.	
7	Press the "Functions menu" button to confirm.	
8	Use the tilt selector switch to choose "YES".	
9	Press the "Functions menu" button to confirm. Result: <ul style="list-style-type: none"> ▪ A new cooking step is appended to the recipe. ▪ The new cooking step is highlighted and all cooking program buttons flash. 	
10	Now enter the cooking data for the new cooking step.	

Deleting a cooking step

To delete a cooking step from a recipe, follow the steps below:

Step	Action	Button
1	Press the "Write/Edit menu" button. Result: The "Cookbook menu" appears in the display.	
2	Use the tilt selector switch to choose the "Edit recipe" icon.	
3	Press the "Write/Edit menu" button to confirm. Result: The individual cooking steps in the recipe are displayed.	
4	Use the "Next" and "Back" buttons to select the cooking step that you wish to delete.	
5	Press the "Functions menu" button to confirm. Result: The submenu for editing a recipe appears in the display.	
6	Use the tilt selector switch to choose the "Delete step" icon.	
7	Press the "Functions menu" button to confirm.	
8	Use the tilt selector switch to choose "YES".	
9	Press the "Functions menu" button to confirm. Result: The cooking step is deleted.	

Closing the recipe

To exit the recipe, follow the steps below:

Step	Action	Button
1	Press the "Cookbook menu" button	

More on this ...

How to do it

- Retrieving a recipe from the cookbook 101

Next steps

- Entering a cooking program 71
- Basic procedure for entering the cooking data 70
- Basic procedure for selecting extra functions and special programs 78

▶ Working with Press&Go

Objective

The combi steamer lets you assign cookbook recipes and the cleaning program to Press&Go buttons (icons). You can start the assigned recipe or cleaning program at any time with a single touch of the relevant Press&Go button.









Advantages









You enjoy the following benefits:

- The Press&Go buttons make your work quick and easy, because you do not need to enter any settings.
- The Press&Go buttons are ideal for dishes that you prepare regularly, such as crisping up pretzels, or heating up rolls and croissants. This means that you achieve top-quality results every time, even when leaving this job to semi-skilled staff.
- By locking the control panel, you can achieve a high level of production reliability when working with the Press&Go buttons, because your staff cannot change any settings.
- You can pre-heat the combi steamer for meal production quickly and easily by assigning the preheat program to a Press&Go button.

Adding the automatic cleaning program (CONVOClean system) to the cookbook.



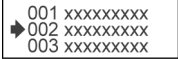

Follow the steps below to add the automatic cleaning program (CONVOClean system) to the cookbook:

Step	Action	Button
1	Press the "Write/Edit menu" button. Result: The "Write/Edit menu" appears in the display.	
2	Use the tilt selector switch to choose the "New recipe" icon. Result: The cooking program buttons flash and 01/01 appears in the display.	 
3	Press the "Functions menu" button. Result: The display shows the function icons.	
4	Use the tilt selector switch to choose the "Automatic cleaning" icon.	 
5	Press the "Functions menu" button to confirm. Result: The Confirm menu appears in the display.	
6	Use the tilt selector switch to choose "YES".	 YES
7	Press the "Functions menu" button to confirm. Result: "Cleaning 01" appears in the display.	

Step	Action	Button
8	Use the tilt selector switch to choose the cleaning level you require. Q = quick clean 1 = light soiling 2 = normal soiling 3 = heavy soiling 4 = heavy soiling with Shine+	 Q, 1, 2, 3, 4
9	Press the "Write/Edit menu" button to confirm. Result: You can now enter the name of the recipe.	
10	Use the tilt selector switch to select the letters, and the "Next" and "Back" buttons to switch between the respective placeholders.	  
11	Press the "Write/Edit menu" button to confirm the finished recipe name.	
12	Use the tilt selector switch to choose a spare memory location. Please note: You can also select and overwrite a memory location that is already occupied.	 
13	Press the "Write/Edit menu" button to confirm. Result: Automatic cleaning is saved in the cookbook.	

Assigning a recipe or cleaning program to a Press&Go button

Follow the steps below to assign a recipe or a cleaning program to a Press&Go button:

Step	Action	Button
1	Press the "Cookbook menu" button. Result: A list of saved recipes appears in the display.	
2	Use the tilt selector switch to choose the recipe or cleaning program you require.	 
3	Hold down the required button of the Press&Go keypad for 3 seconds. Result: <ul style="list-style-type: none"> An audible signal is given. The recipe or cleaning program is assigned to the Press&Go button. 	

5.4 Adjusting the default settings

The default settings of your combi steamer

This chapter presents the default settings of your combi steamer and explains each of the functions they provide.

Contents

This chapter contains the following topics:

	Page
Accessing the default settings	114
Setting the beep signal	115
Adjusting the volume	116
Setting the time	117
Setting the date	118
Sorting alphabetically or numerically	119
Changing the Expert default values and selecting to use last-used values	120
Select temperature display	122
Configuring the network address	123
Saving / loading the cookbook	124
Setting the language	125







▶ Accessing the default settings

Objective

You wish to modify the default settings to suit your needs.

Accessing the default settings

Follow the steps below to access the selection menu for the default settings:

Step	Action	Button
1	Press the "Functions menu" button. Result: The display shows the function icons.	
2	Use the tilt selector switch to choose the "default settings" icon.	 
3	Press the "Functions menu" button to confirm. Result: The Confirm menu appears in the display.	
4	Use the tilt selector switch to choose "YES".	 YES
5	Press the "Functions menu" button to confirm. Result: The display shows the icons for the default settings.	

Closing the functions menu

To exit the functions menu, follow the steps below:

Step	Action	Button
1	Press the "Start/Stop" button.	

▶ Setting the beep signal

Objective





You can use the "Beep signal" default setting to set the audible signal.

Requirements

The display shows the icons for the default settings.

Setting the beep signal

Follow the steps below to set the beep signal:

Step	Action	Button
1	Use the tilt selector switch to choose the "Beep signal" icon.	 
2	Press the "Functions menu" button to confirm. Result: Various options appear in the display.	
3	Use the tilt selector switch to choose the audible signal you require.	 01-12
4	Press the "Functions menu" button to confirm. Result: The beep signal is set.	

▶ Adjusting the volume

Objective





You can use the "Volume" default setting to adjust the volume.

Requirements

The display shows the icons for the default settings.

Adjusting the volume

Follow the steps below to set the volume:

Step	Action	Button
1	Use the tilt selector switch to choose the "Volume" icon.	
2	Press the "Functions menu" button to confirm. Result: Various options appear in the display.	
3	Use the tilt selector switch to choose your desired volume level.	
4	Press the "Functions menu" button to confirm. Result: The volume is set.	

▶ Setting the time

Objective

If the combi steamer is disconnected from the power supply for more than three days, you will need to set the date and time again.







You can use the "Time" default setting to set and save the current time.

Requirements

The display shows the icons for the default settings.

Setting the time

Follow the steps below to set the time:

Step	Action	Button
1	Use the tilt selector switch to choose the "Time" icon.	 
2	Press the "Functions menu" button to confirm. Result: A selection list of optional time formats appears in the display.	
3	Use the tilt selector switch to choose the time format you require.	 15:00 03:00 pm
4	Use the "Next" and "Back" buttons to toggle between hours and minutes.	
5	Enter the current time using the tilt selector switch.	 16:51 04:51 pm
6	Press the "Functions menu" button to confirm. Result: The current time is saved.	

▶ Setting the date

Objective

If the combi steamer is disconnected from the power supply for more than three days, you will need to set the date and time again.







You can use the "Date" default setting to set and save today's date.

Requirements

The display shows the icons for the default settings.

Setting the date

Follow the steps below to set the date:

Step	Action	Button
1	Use the tilt selector switch to choose the "Date" icon.	 
2	Press the "Functions menu" button to confirm. Result: A selection list of optional date formats appears in the display.	
3	Use the tilt selector switch to choose the date format you require.	 20.05.2009 05-20-2009
4	Use the "Next" and "Back" buttons to scroll between day, month and year.	
5	Enter today's date using the tilt selector switch.	 28.05.2009 05-28-2009
6	Press the "Functions menu" button to confirm. Result: Today's date is saved.	

▶ **Sorting alphabetically or numerically**

Objective

You can use the "Sort alphabetically" default setting to specify whether recipes are sorted alphabetically by name or numerically by storage location.





Depending on how many recipes are saved, changing from alphabetical to numerical sorting or vice versa can take some time.

Requirements

The display shows the icons for the default settings.





Sorting alphabetically

Follow the steps below to sort the recipes in the cookbook alphabetically:

Step	Action	Button
1	Use the tilt selector switch to choose the "Alphabetic cookbook" icon.	
2	Press the "Functions menu" button to confirm. Result: The Confirm menu appears in the display.	
3	Use the tilt selector switch to choose "YES".	 YES
4	Press the "Functions menu" button to confirm. Result: Alphabetical sorting is set as the sorting method.	

Sorting numerically

Follow the steps below to sort the storage locations numerically:





Step	Action	Button
1	Use the tilt selector switch to choose the "Alphabetic cookbook" icon.	
2	Press the "Functions menu" button to confirm. Result: The Confirm menu appears in the display.	
3	Use the tilt selector switch to choose "NO".	 NO
4	Press the "Functions menu" button to confirm. Result: Numerical sorting is set as the sorting method.	

▶ Changing the Expert default values and selecting to use last-used values

Objective

When selecting a cooking program, you can use the default setting "Expert default values" to specify whether you wish the Expert default values or the last-used values to appear in the display for the cooking time and oven temperature.

In addition, you can customize the following factory-preset Expert default values to suit your needs:

Cooking program	Cooking temperature	Core temperature	Cooking time
	100°C	70°C	25 min
	150°C	70°C	70 min
	170°C	70°C	30 min
	135°C	70°C	5 min

Advantages

You enjoy the following benefits:







- Using Expert default values helps to cut operating mistakes, especially when you are working with semi-skilled staff. Whenever a cooking program is selected, it is backed by the values that you have specified.
- Last-used values are the ideal option when you regularly cook several batches one after the other. You can then start the cooking program immediately without needing to select the time and temperature values.







Requirements

The display shows the icons for the default settings.

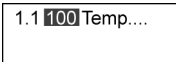
Changing Expert default values

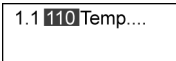

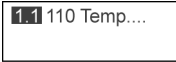



Follow the steps below to change the Expert default values:

Step	Action	Button
1	Use the tilt selector switch to choose the "Expert default value" icon.	 
2	Press the "Functions menu" button to confirm. Result: The Confirm menu appears in the display.	
3	Use the tilt selector switch to choose "YES".	 YES
4	Press the "Functions menu" button to confirm. Result: The display shows a selection list containing the Expert default values that have been set.	
5	Use the tilt selector switch to choose the "Expert default value" that you wish to modify.	 

Step	Action	Button
6	Use the "Next" button to scroll to the numerical value.	 
7	Use the tilt selector switch to set the desired value. e. g. the value of the cooking temperature for steaming.	 
8	Scroll back using the "Back" button in order to save the value.	 
9	Repeat steps 6 and 7 to edit other Expert default values.	
10	Press the "Functions menu" button to confirm the settings you have made. Result: The Expert default values are set to new values.	

Selecting to use last-used values

Follow the steps below to select to use last-used values:

Step	Action	Button
1	Use the tilt selector switch to choose the "Expert default value" icon.	 
2	Press the "Functions menu" button to confirm. Result: The Confirm menu appears in the display.	
3	Use the tilt selector switch to choose "NO".	 
4	Press the "Functions menu" button to confirm. Result: The combi steamer now uses the last-used values.	

▶ Select temperature display

Objective

You can use the default setting "Temperature in °C" to select between °C or °F for the temperature display.

Restriction





When the temperature display is changed, there is **no** change to the data in the cookbook. These values must be changed manually.

Requirements

The display shows the icons for the default settings.





Setting the temperature display to °C

Follow the steps below to set the temperature display to °C:

Step	Action	Button
1	Use the tilt selector switch to choose the "Temperature in °C" icon.	
2	Press the "Functions menu" button to confirm. Result: The Confirm menu appears in the display.	
3	Use the tilt selector switch to choose "YES".	
4	Press the "Functions menu" button to confirm. Result: The temperature display is set to °C.	

Setting the temperature display to °F

Follow the steps below to set the temperature display to °F:

Step	Action	Button
1	Use the tilt selector switch to choose the "Temperature in °C" icon.	
2	Press the "Functions menu" button to confirm. Result: The Confirm menu appears in the display.	
3	Use the tilt selector switch to choose "NO".	
4	Press the "Functions menu" button to confirm. Result: The temperature display is set to °F.	

► Configuring the network address

Objective

The network address is needed in order to use PC-Control, PC-HACCP and Convotherm Service System.

You can use the "Network address" default setting to set the network address.





Requirements

To do this, the following requirements must be satisfied:

- The display shows the icons for the default settings.
- The network address intended for the appliance must not already be in use by another appliance.

Configuring the network address

Follow the steps below to set the network address:

Step	Action	Button
1	Use the tilt selector switch to choose the "network address" icon.	
2	Press the "Functions menu" button to confirm. Result: The currently set network address is displayed.	
3	Use the tilt selector switch to choose the desired network address.	 01-120
4	Press the "Functions menu" button to confirm. Result: The network address is set.	

▶ Saving / loading the cookbook

Objective





You can use the "Save / load cookbook" default setting to save or load the cookbook.

Requirements

The display shows the icons for the default settings.





Saving the cookbook

Follow the steps below to save the cookbook:

Step	Action	Button
1	Use the tilt selector switch to choose the "Save cookbook" icon.	
2	Press the "Functions menu" button to confirm. Result: The Confirm menu appears in the display.	
3	Use the tilt selector switch to choose "YES".	 YES
4	Press the "Functions menu" button to confirm. Result: The cookbook has been saved.	

Loading the cookbook

Follow the steps below to load the cookbook:

Step	Action	Button
1	Use the tilt selector switch to choose the "Load cookbook" icon.	
2	Press the "Functions menu" button to confirm. Result: The Confirm menu appears in the display.	
3	Use the tilt selector switch to choose "YES".	 YES
4	Press the "Functions menu" button to confirm. Result: The cookbook has been loaded.	

▶ Setting the language

Objective





You can use the "Language" default setting to set the language.

Requirements

The display shows the icons for the default settings.

Setting the language

Follow the steps below to set the language:

Step	Action	Button
1	Use the tilt selector switch to choose the "Language" icon.	
2	Press the "Functions menu" button to confirm. Result: Various options appear in the display.	
3	Use the tilt selector switch to choose the language you require.	
4	Press the "Functions menu" button to confirm. Result: The language is set.	

6 Your combi steamer cooking programs

The cooking programs

Your combi steamer provides you with the following preset main cooking programs:

- Steaming
- Superheated steam
- Convection
- Regenerate

Working from these main cooking programs, you can cook all sorts of food to a high quality and in shorter times.

In addition to the main cooking programs, your combi steamer also provides a number of special cooking programs that are based on the main cooking methods:

- Low-temperature cooking, suitable for low-oxygen slow cooking and overnight cooking
- Delta-T cooking
- Cook & Hold
- Overnight cooking
- ecoCooking

You can combine the core temperature control function with all main and special cooking programs; for some special cooking programs e.g. sous-vide cooking, you must use this function.

General advantages of your combi steamer

You can enjoy the following advantages for all methods of cooking:

- You always achieve the optimum atmosphere inside the oven.
- Flavors are not transferred, even when you cook different foods in one load.
- You do not need to enter humidity levels manually.

Developing your own recipes

You can combine the main and special cooking programs (plus the core temperature control function if required) into your own single-stage or multistage recipes. You can then save them in the cookbook for retrieval using Press&Go.

This section provides basic guidelines for adapting the cooking programs to suit the specific requirements of your products. How you design your own personal recipes is obviously up to you and your customers.

Contents

This chapter contains the following topics:

	Page
Steaming	127
Superheated steam	129
Convection	130
Regenerate	131
Core temperature control	133
Delta-T cooking	135
Cook & Hold	137
Overnight cooking	139

► Steaming

Temperature range

When you use the "Steam" cooking program, you are working in the 30 °C to 120 °C temperature range.

The steaming process is classified according to temperature

- Low-temperature steaming (30 - 99°C)
- Steaming (100°C)
- Quick steaming (101 - 120°C)

Usage

The "Steam" cooking program is suitable for the cooking methods

- Boiling
- Steaming
- Blanching
- Poaching
- Preserving

Special programs in which "steaming" is used are

- low-oxygen slow cooking
- Low-temperature cooking
- Overnight cooking

Advantages of steaming at 100 °C

You enjoy the following benefits:

- Steaming is particularly good at preserving vitamins, minerals and secondary plant substances such as color and fiber.
- You can work quickly because steam is constantly available.

Examples of use for steaming at 100 °C

The cooking program is suitable for instance for

- Vegetables
- Rice
- Durum wheat pasta
- Potato dumplings
- Dumplings
- Small dumplings
- Potatoes

Advantages of low-temperature steaming between 30 °C and 99 °C

You enjoy the following benefits:

- You can prepare foods while preserving their goodness.
- You can avoid burst skins when boiling or heating up sausages.
- You achieve optimum culinary results for sensitive foods such as terrines, galantines, flans, farces, crème caramels and dietary foods.
- Highly accurate cooking temperatures allow proteins in food to cook perfectly (such as with fish).

Examples of use for low-temperature steaming between 30 °C and 99 °C

The cooking program is suitable for instance for

- Fish fillets
- Terrines
- Galantines
- Flans
- Stuffings
- Dumplings
- Crème caramel

Advantages of quick steaming between 101 °C and 120 °C

You enjoy the following benefits:

- You save time

Examples of use for quick steaming between 101 °C and 120 °C

The cooking program is suitable for less sensitive foods such as

- Jacket potatoes
- Beetroot
- Turnips
- Pulses
- Cabbage

The cooking program is also particularly good for food for which slight browning is required with steaming, such as

- Rolls of beef
 - Stuffed cabbage
 - Beef goulash
-

► Superheated steam

Temperature range

When you use the "Superheated steam" cooking program, you are working in the 100 °C to 250 °C temperature range.

Usage

The "Superheated steam" cooking program is suitable for all foodstuffs for which moisture or steam is added manually in the traditional cooking methods, for instance

- Roast pork by basting
- Danish pastries for optimum "rising"

Advantages

You enjoy the following benefits:

- Food does not dry out
- Baked items such as yeast and bread dough or puff pastry rise perfectly during baking
- If required, you can extract moisture from the oven (Crisp&Tasty function) to achieve juicy, crispy products that are evenly browned all over
- Ultra-fast energy transfer

Making optimum use of the cooking program

You should remember the following points:

- Generally you can reduce the oven temperature by 10 to 20% compared with traditional cooking methods, and avoid significant loss in weight during cooking.

Examples of use

The cooking program is suitable for

- Large roasting joints
 - Poultry (duck, goose)
 - Gratins and bakes
 - Baked items such as Danish pastries, baguettes etc.
 - Cheesecake
 - Apple strudel
-

► Convection

Temperature range

When you use the "Convection" cooking program, you are working in the 30 °C to 250 °C temperature range.

Usage

The "Convection" cooking program is suitable for all cooking techniques that do not require moisture, such as

- Roasting
- roasting bones
- Baking
- Grilling
- scalloping

Advantages

You enjoy the following benefits:

- If required, you can extract moisture from the oven to achieve crisp, crunchy products that are evenly browned all over.
- By removing the moisture (Crisp&Tasty function), you can achieve a fine crust in baking.

Making optimum use of the cooking program

You should remember the following points:

- Generally you can reduce the oven temperature by 10 to 20% compared with traditional cooking methods, and avoid significant loss in weight during cooking.

Examples of use

The cooking program is suitable for

- quick roasting cuts such as steaks and medallions
 - Fat-free finger food
 - gratins
 - As an alternative to deep-frying potato products (fat-free french fries), etc.
 - fruit tarts
-

▶ Regenerate

Usage

The "Regenerate" cooking program is suitable for regenerating prepared dishes that have already been arranged on plates, platters or in GN containers.

Temperature range and regeneration time

The regeneration time and temperature depend on the product, its thickness and on the number of plates or GN containers to be regenerated (see recommended values in this section).

Advantages

You enjoy the following benefits:

- Cook & Chill concept: during quiet times you can create dishes when you are less busy and arrange them cold on plates or platters.
- You can regenerate on demand however many plates you need.
- Pre-prepared dishes do not dry out during regeneration.
- There are no puddles of condensation on the plates or dry edges.
- Mixed regeneration of plates / GN containers is possible.

Making optimum use of the cooking program

You should remember the following points:

- Solid foodstuffs such as dumplings or dough balls, rolled beef and casseroles take longer to regenerate than items such as slices of meat, vegetable accompaniments, rice and quartered or diced potatoes.
- When arranging the food, avoid large areas of food overlapping and different heights of food.
- Place fish and meat on a bed of rice or the like to ensure even regeneration without sticking to the plate.
- Pre-cook food to 80% of its final requirement; for instance only roast meat until it is rare, if medium is the final result required after regeneration.
- Butter vegetables, rice and pasta before regenerating.
- Do not add sauces to the plate until after regenerating.

Examples of use

The regenerate program is suitable for

- almost all types of dishes

Recommended values for regenerating

Follow these rules for regenerating:

- Always preheat the combi steamer.
- After each regenerate cycle, always reheat to the preheat temperature. You can start the regenerating program again as soon as the preheat temperature is reached.

The following recommended values are for a full load:

OEB, OGB OES, OGS	Plate capacity up to ø 32 cm Plate gap 66 mm	Plate capacity up to ø 32 cm Plate gap 80 mm	Preheat tem- perature with superheated steam	Preheat time	Regenerating temperature	Regenera- ting time
6.10	20	-	180 °C	2 min	125 - 135 °C	4 - 8 min
6.20	39	-	180 °C	2 min	125 - 135 °C	4 - 8 min
10.10	32	-	180 °C	2 min	125 - 135 °C	4 - 8 min
10.20	60	-	250 °C	3 min	135 - 140 °C	6 - 10 min
12.20	74	59	250 °C	3 min	135 - 140 °C	6 - 10 min
20.10	61	50	250 °C	3 min	135 - 140 °C	6 - 10 min
20.20	122	98	250 °C	3 min	135 - 140 °C	6 - 10 min

► Core temperature control

The principle

The core temperature control function uses the core temperature inside the food to control the length of the cooking process rather than the time.

The core temperature control function can be used with all main cooking programs.

Usage

Measuring the core temperature is particularly recommended for cooking slow roasts and when aiming for a precise result (medium, rare etc.).

Advantages

You enjoy the following benefits:

- You can cook with precision regardless of joint size or weight, guaranteeing perfect quality every time.
- There is no need to waste time and energy keeping an eye on the joint and checking the degree of cooking.
- The multipoint sensor takes measurements at several points along the sensor tip, and automatically identifies the coolest core temperature it measures as the center of the joint of meat. The multipoint sensor prevents false readings and makes it easier to use the sensor.
- Combined with the cooking programs, you can achieve up to a 50% improvement in cooking.

Making optimum use of the cooking method

You should remember the following points:

- When setting the final core temperature, remember that slow roasts continue to cook inside after they have been removed from the combi steamer.
- At the end of cooking, you should remove the slow roast from the combi steamer immediately and cool it rapidly. This prevents overcooking.

Recommended values for the core temperature

Please follow the recommended values below:

Food	Degree of cooking	Core temperature
Beef		
Fillet of beef, roast beef	Medium	50 - 54 °C
Braised beef	Well done	82 - 90 °C
Rolled beef, topside	Well done	82 - 95 °C
Veal		
Saddle of veal	Medium	54 - 58 °C
Breast of veal, shoulder of veal	Well done	75 - 80 °C
Leg of veal	Well done	76 - 78 °C
Pork		
Loin of pork	Medium	68 - 72 °C
Neck of pork	Medium	68 - 72 °C
Belly of pork, knuckle of pork	Well done	72 - 78 °C
Cured pork	Medium	65 - 68 °C
Lamb		
Leg of lamb	Medium	54 - 64 °C
Saddle of lamb	Medium	52 - 56 °C
Poultry		
Whole chicken	Well done	75 - 82 °C
Breast of chicken	Well done	75 - 77 °C
Chicken leg	Well done	75 - 82 °C
Fish		
Cuts of salmon	Medium	63 - 65 °C

▶ Delta-T cooking

The principle

ΔT cooking is a cooking program in which the oven temperature increases according to the core temperature. This option must always be used with the core temperature sensor.

The Delta-T cooking program

Enter the cooking program data in the 'Cook' page. You must enter the following values:



Button	Meaning	Function
ΔT	Δ temperature	Specifies the temperature in the oven relative to the core temperature.
	Core temperature	The cooking program is stopped when this value is reached.

The cooking process

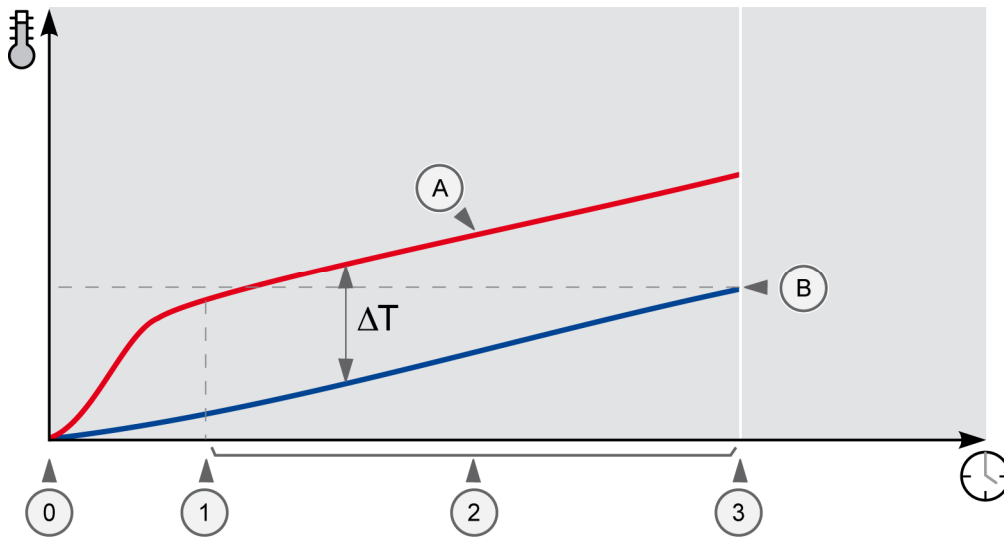
The following diagram shows the cooking process:



No.	Meaning	Description
(A)	Temperature inside the oven	Temperature curve inside the oven
(B)	Core temperature	Value entered for the core temperature

No.	Meaning	Description	Temperature inside the oven ^(A)
0	Start of phase 1	Program start: the core temperature and oven temperature rise.	Heating-up phase
1	End of phase 1	The oven temperature equals the sum of the Δ temperature and the actual core temperature.	$\Delta T +$  at that moment
2	Phase 2	The oven temperature continues to rise in line with the instantaneous core temperature until the core temperature has reached the specified value.	$\Delta T +$  at that moment
3	End of phase 2	End of program: The core temperature ^(B) is reached.	$\Delta T +$ 

Usage

ΔT -cooking is particularly suitable for gentle cooking of boiled ham, entire fish, galantines and egg royale.

Advantages

You enjoy the following benefits:

- Meat stays juicy and tender and suffers little shrinkage during roasting.
- Use the start time preset to make the most of low-usage periods when performing ΔT cooking (for instance at night).

Making optimum use of the cooking method

You should remember the following points:

- The higher the Δ temperature the greater the loss in weight and the higher the level of browning of the food.
-

▶ Cook & Hold

The principle

Cook&Hold is a 2-stage cooking program containing a Cook phase and a Hold phase, in which the temperature is held at a specified level.

It requires the following settings

- a cooking program: superheated steam or convection
- a switch-over core temperature
- a final core temperature

This option must always be used with the core temperature sensor.

The Cook & Hold cooking program

You must enter the following values:

Program step	Meaning	Function
1	Cooking temperature	Required cooking temperature in the Cook phase
	Core temperature = switch-over core temperature	Defines the end of the Cook phase and the start of the Hold phase.
2	Cooking temperature = hold core temperature	The required hold temperature equals the final core temperature

The cooking process

The following diagram shows the cooking process:

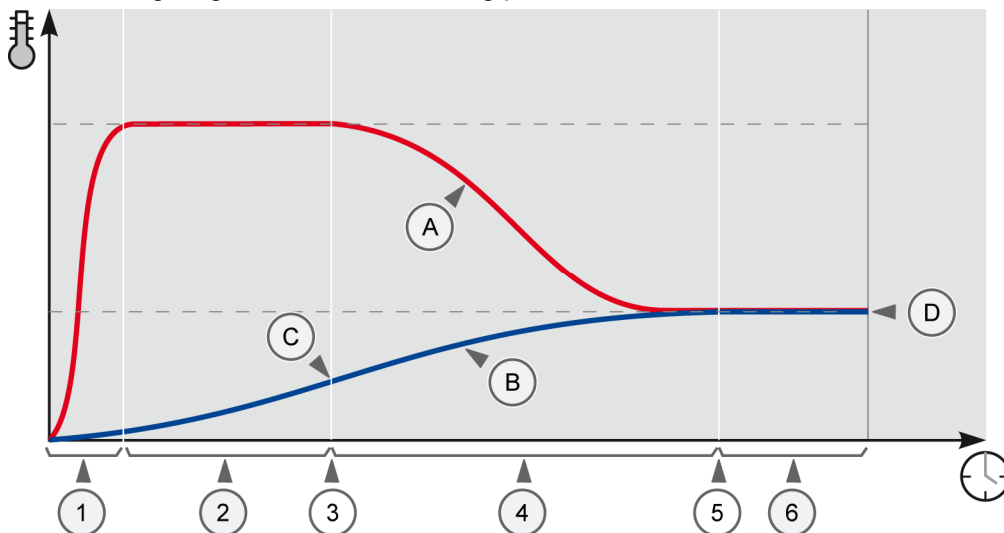

No.	Meaning	Description
Ⓐ	Temperature inside the oven	Temperature curve inside the oven
Ⓑ	Core temperature of the food	Change in the core temperature of the food
Ⓒ	Switch-over core temperature	Value entered for the switch-over core temperature
Ⓓ	Hold temperature	Value entered for the final core temperature

No.	Meaning	Description	Temperature inside the oven Ⓐ
1	Phase 1	Heating-up phase: The temperature inside the food and inside the oven rises.	Oven temperature rises
2	Phase 2 (Cook)	The cooking program runs until the core temperature reaches the switch-over level Ⓒ.	The oven temperature has reached the value entered for the cooking temperature
3	End of phase 2	The core temperature has reached the switch-over temperature Ⓒ.	The oven temperature has reached the value entered for the cooking temperature
4	Phase 3 (Hold)	The cooking program runs at the hold temperature. Result: <ul style="list-style-type: none"> ▪ The oven temperature falls. ▪ The product gradually finishes its cooking. 	The oven temperature falls
5	End of phase 3	As soon as the oven temperature reaches the hold temperature Ⓓ, the product is ready to serve.	Hold temperature reached
6	Phase 4 (Hold)	The oven can be kept at the hold temperature Ⓓ up to the maximum keep-warm time.	Oven kept at hold temperature

Usage

Long before you need the finished dish, you can make use of periods of low activity to prepare food as usual, place it in the combi steamer and start Cook & Hold.

Cook & Hold can also be used for overnight cooking.

Advantages

You enjoy the following benefits:

- In the Cook phase, meat is cooked in convection or superheated-steam cooking modes.
- In the Hold phase, the product finishes cooking very gradually, preserving its quality.

Making optimum use of the cooking method

You should remember the following points:

- In the Cook phase, a temperature range of 120°C to 150°C is best for the convection and superheated-steam cooking programs.
- The temperature for switching into the Hold phase depends on the amount of food in the oven, the type of meat and the size of the piece of meat.
- Set the hold temperature to the target core temperature you require so that the food cannot be overcooked.

► Overnight cooking

The principle

Overnight cooking is a multi-step, slow-cooking program containing multiple cooking steps and a final hold phase during which the product finishes cooking gradually.

It requires the following settings

- a cooking program: MEDIUM overnight cooking, WELL DONE overnight cooking or BOIL overnight cooking

The "MEDIUM overnight cooking" and "WELL DONE overnight cooking" process

The following diagram shows the cooking process:

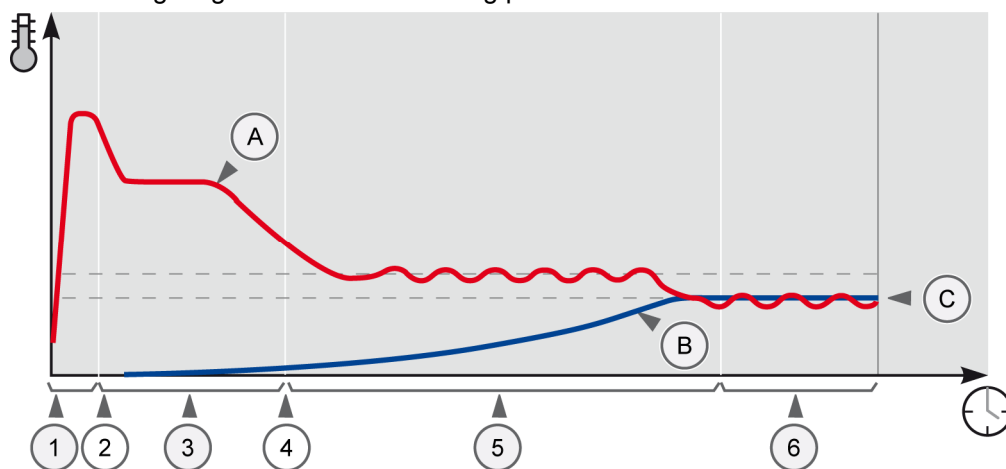

No.	Meaning	Description
Ⓐ	Temperature inside the oven	Temperature curve inside the oven
Ⓑ	Actual core temperature	Curve showing core temperature of product
Ⓒ	Hold temperature	Final core temperature

No.	Meaning	Description	Oven temperature [Ⓐ]	
			WELL DONE	MEDIUM
1	Preheating	The oven preheats. Oven temperature rises. 2 minutes hold time.	150°C	150°C
2	Loading	Loading the oven. A mixed load is also possible		
3	Searing phase	Product is seared for 10 minutes.	130°C	130°C
4	Temperature drop	Oven temperature is lowered. Time period depends on product.		
5	Gradual cooking phase	Product cooked gradually until the final core temperature is reached.	78°C	65°C
6	Hold time	Hold phase for up to 15 hours	72°C	52°C

The "BOIL overnight cooking" process

The following diagram shows the cooking process:

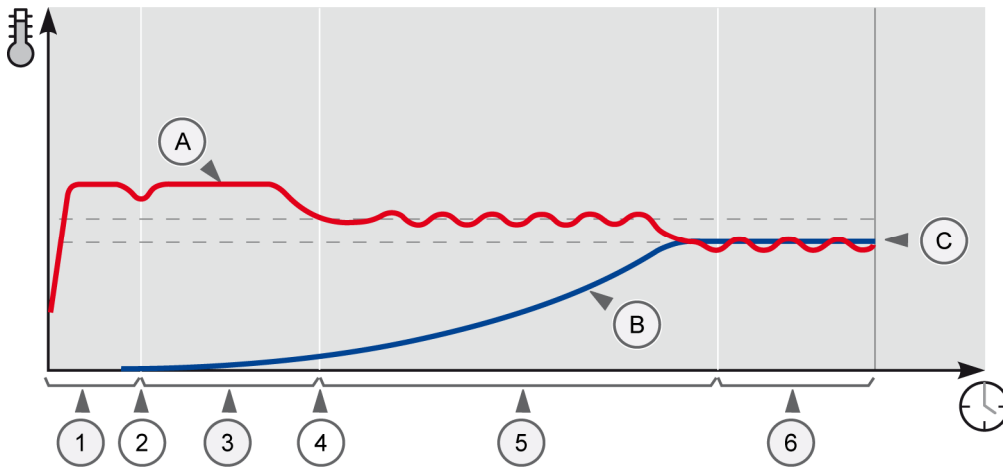

No.	Meaning	Description
Ⓐ	Temperature inside the oven	Temperature curve inside the oven
Ⓑ	Actual core temperature	Curve showing core temperature of product
Ⓒ	Hold temperature	Final core temperature

No.	Meaning	Description	Oven temperature Ⓐ
1	Preheating	The oven preheats. Oven temperature rises. 2 minutes hold time.	100°C
2	Loading	Loading the oven. A mixed load is also possible	
3	Boiling phase	Product is boiled for 10 minutes.	100°C
4	Temperature drop	Oven temperature is lowered. Time period depends on product.	
5	Gradual cooking phase	Product cooked gradually until the final core temperature is reached.	80°C
6	Hold time	Hold phase for up to 15 hours	72°C

Usage

Long before you need the finished dish, you can make use of periods of low activity to prepare food very slowly, e.g. overnight, to preserve its goodness.

You can use overnight cooking for the following products:

- MEDIUM overnight cooking: particularly suitable for roast beef
- WELL DONE overnight cooking particularly suitable for roast pork and rolled beef
- BOIL overnight cooking: particularly suitable for topside

Advantages

You enjoy the following benefits:

- You achieve a juicy product with little loss in weight compared with conventional preparation
- Slow, gradual cooking ensures extremely even cooking of the product

Making optimum use of the cooking method

You should remember the following points:

- The hold phase cannot exceed 15 hours
 - Where different types or sizes of joints of meat are being cooked, insert the core temperature sensor in the smallest joint
-

7 Using the cooking programs

Tried and tested recipes to inspire you

This section contains some tried and tested recipes to inspire you to develop your own recipes.

Contents



















This chapter contains the following topics:

	Page
Side dishes	143
Fish	144
Meat, game, poultry	145
Pastries and baked desserts	147

► Side dishes

Recipes for side dishes















Typical recipes for side dishes:

Dish					Points to note
		°C	min	°C	
Eggs		100	8-16	-	<ul style="list-style-type: none"> No need to skewer soft-boiled after approx. 10 min hard-boiled after approx. 15 min
Royale		85	20-25	-	
Fresh vegetables		100	5-15	-	<ul style="list-style-type: none"> Diced
Frozen vegetables		100	8-15	-	
Potatoes (halved)		100	25-35	-	<ul style="list-style-type: none"> Soak in salted water or sprinkle with fine salt 15 minutes before cooking
Dumplings/dough balls		100	25-30	-	<ul style="list-style-type: none"> Place on greased baking sheet; cover immediately after cooking
Pasta (durum wheat semolina)		120	10-15	-	<ul style="list-style-type: none"> use unperforated containers; no need to stir 1 part pasta, min. 5 parts cold water
Frozen omelette		85	15-20	-	
Jacket potatoes		110	30-35	-	
French fries		200	8-12	-	<ul style="list-style-type: none"> use frying basket for larger quantities in the oven, switch on Crisp&Tasty (level 2)
Rice		100	25-30	-	<ul style="list-style-type: none"> Soak for 20 minutes use unperforated containers 1 part rice 1.5 to 2 parts cold water or stock Lid advisable above 100 °C
Fresh scrambled egg		160	5-10	-	<ul style="list-style-type: none"> select lower fan speed
Frozen scrambled egg		85	15-20	-	
Wedges		210	10-12	-	<ul style="list-style-type: none"> use frying basket Every other shelf for larger quantities in the oven, switch on Crisp&Tasty (level 2)

► Fish

Recipes for fish

































Typical recipes for fish

Dish					Points to note
		°C	min	°C	
Fish wrapped in cabbage		89	-	69	
Breaded fish fillet		220	10-13	-	<ul style="list-style-type: none"> ▪ use every other shelf ▪ use non-stick baking tray ▪ switch on Crisp&Tasty (level 2)
Fish quenelles		78	5-12	-	
Fish pâté		78	-	65	▪ use every other shelf
Baked trout		220	8-12	-	<ul style="list-style-type: none"> ▪ use every other shelf ▪ switch on Crisp&Tasty (level 2)
Baked prawns		200	4-8	-	▪ use every other shelf
Steamed prawns		80	4-8	-	▪ use every other shelf
Baked salmon fillet		220	6-12	-	▪ use every other shelf
Steamed salmon fillet		78	5-10	-	
Baked plaice		225	7-10	-	▪ switch on Crisp&Tasty (level 2)
Baked sole		225	10-12	-	▪ switch on Crisp&Tasty (level 2)





















► Meat, game, poultry

Recipes for meat, game and poultry

Typical recipes for meat, game and poultry

Dish					Points to note
		°C	min	°C	
Fried sausage		210	7-12	-	
Cordon Bleu		200	10-13	-	▪ switch on Crisp&Tasty (level 2)
Duck		150	-	85	▪ Stuff with apples and onions if required
Breast of duck		225	-	50	
Fillet steak 200g		220	-	47	
Meat kebab - barbecue		210	8-12	-	▪ spit rack (x.20 appliances only)
Rissoles		180	-	78	▪ Grease baking sheets
Goose		135	-	90	▪ Add liquid occasionally
Meat loaf		135	-	85	▪ shape into a loaf or firm into baking tin
Leg of hare		135	-	72	▪ Dot with fat or braise in stock if required
Roast venison		135	-	68	▪ Place joint in deep container and top up with stock gradually
Knuckle of veal		135	-	78	▪ steam first for 10 minutes, then score the rind
Rolled roast veal		135	-	78	
Veal steak 180g		225	-	47	
Cured pork cutlet		180	10-12	-	▪ Grease baking sheets
Boiled ham		78	-	65	▪ Cooking time depends on weight
Rolled cabbage		135	-	82	
Breaded cutlet		210	10-12	-	▪ switch on Crisp&Tasty (level 2)
Roast lamb		130	-	78	
Lamb carrée, medium		200	-	48	
Leg of lamb, medium		125	-	50	
Liver loaf, fresh sausage-meat		125	-	68	
Sliced liver		210	4-6	-	▪ do not coat in flour
Stuffed peppers		130	-	82	
Turkey		125	-	72	▪ Fill with stuffing and herbs if required
Baked turkey breast		180	-	72	▪ Fill with stuffing and herbs if required
Steamed turkey breast		89	-	72	
Turkey escalope		210	9-13	-	▪ switch on Crisp&Tasty (level 2)



















Using the cooking programs

Dish					Points to note
		°C	min	°C	
Venison trimmed off bone		135	-	72	▪ Rub with fat or marinate if required
Venison pie		150	-	72	▪ Always use pie funnels
Fillet of beef, medium		125	-	50	
Fillet of beef Wellington		150	-	48	▪ brush pastry lightly with egg, sauté fillet first
Braised beef		130	-	82	
Roast beef, medium		125	-	50	
Rump steak 200g		210	-	48	
Escalope		210	8-11	-	▪ switch on Crisp&Tasty (level 2)
Roast pork		130	-	78	
Pork fillet joint		210	-	53	
Pork fillet medallion		210	-	48	
Neck of pork		135	-	78	
Loin of pork joint		135	-	72	
Knuckle of pork		135	-	72	▪ steam first for 10 minutes, then score the rind
Veal sausage		65	10-20	-	
Wiener sausage / Frankfurter		75	10-20	-	
Leg of boar		135	-	72	

► Pastries and baked desserts

Pastries and baked desserts

Typical recipes for pastries and baked desserts:

Dish					Points to note
		°C	min	°C	
Apple strudel		175	12-20	-	<ul style="list-style-type: none"> ▪ use every other shelf ▪ Number on sheet depends on size ▪ Do not place items too close together on sheet
Frozen baguette		165	6-15	-	<ul style="list-style-type: none"> ▪ Number on sheet depends on size ▪ Do not place items too close together on sheet
Sponge bases		150	15-20	-	<ul style="list-style-type: none"> ▪ select lower fan speed
Baked slices		165	25-35	-	<ul style="list-style-type: none"> ▪ use every other shelf
Pretzels		155	12-15	-	<ul style="list-style-type: none"> ▪ Number on sheet depends on size ▪ Do not place items too close together on sheet
Frozen rolls		165	10-12	-	<ul style="list-style-type: none"> ▪ Number on sheet depends on size ▪ Do not place items too close together on sheet
Crème Brûlée		80	10-15	-	<ul style="list-style-type: none"> ▪ select lower fan speed
Crème caramel		80	15-25	-	<ul style="list-style-type: none"> ▪ select lower fan speed
Frozen croissants		165	15-22	-	<ul style="list-style-type: none"> ▪ Number on sheet depends on size ▪ Do not place items too close together on sheet
Cheesecakes		145	30-40	-	<ul style="list-style-type: none"> ▪ use every other shelf ▪ select lower fan speed
Shortcrust pastry		165	10-15	-	<ul style="list-style-type: none"> ▪ Number on sheet depends on size ▪ Do not place items too close together on sheet
fruit tarts		165	25-35	-	<ul style="list-style-type: none"> ▪ use every other shelf
Frozen flaky pastry		165	14-20	-	<ul style="list-style-type: none"> ▪ Number on sheet depends on size ▪ Do not place items too close together on sheet
Madeira cake		165	20-35	-	<ul style="list-style-type: none"> ▪ use every other shelf
Small biscuits and cakes		165	8-13	-	<ul style="list-style-type: none"> ▪ Number on sheet depends on size ▪ Do not place items too close together on sheet ▪ select lower fan speed

8 Cleaning and Maintenance

Cleaning and maintaining the combi steamer

This chapter presents the cleaning and maintenance schedule and gives cleaning instructions for your combi steamer.

Contents

This chapter contains the following topics:

	Page
Cleaning and maintenance schedule	149
Semi-automatic oven cleaning	153
Fully automatic oven cleaning (CONVOClean system option)	156
Emptying and rinsing the steam generator	158
Descaling early warning (only on OEB)	159
Cleaning agents	160
Troubleshooting	161
Rectifying faults - Irregularities during operation	163

► Cleaning and maintenance schedule

Hot steam

▲WARNING

Risk of scalding from hot steam

If water is sprayed into the hot oven using the hand shower, steam will be produced that may scald.

- ▶ Do not clean until the oven interior has cooled to below 60 °C.

Cleaning agents

▲WARNING

Risk of skin and eye irritation or chemical burns

Direct contact with the CONVOClean new and CONVOCare cleaning agents will irritate the skin and eyes. Direct contact with CONVOClean forte will result in chemical burns.

- ▶ Do not inhale the spray mist.
- ▶ Do not let the cleaning agent come into contact with eyes or skin.
- ▶ Never open the appliance door during fully automatic cleaning.
- ▶ Wear protective gloves and safety goggles as specified in safety data sheet.

Skin burns

▲WARNING

Risk of skin burns

The CONVOClean forte cleaning agent will cause skin burns if there is any direct contact, and care must be exercised when handling the cleaning canisters.

- ▶ Do not inhale the spray mist.
- ▶ Do not let CONVOClean forte come into contact with eyes or skin.
- ▶ Never open the appliance door during fully automatic cleaning.
- ▶ Wear protective clothing, protective gloves and safety goggles as specified in safety regulations.

Requirements

Check that the following requirements have been met before carrying out any cleaning or maintenance tasks:

- You are already conversant with the operating steps listed under "How to do it correctly".

Daily cleaning tasks

The following table lists the cleaning tasks that you must perform daily:

What must be cleaned?	Procedure	Cleaning agents
Oven	<i>Semi-automatic oven cleaning</i> on page 153	CONVOClean new for slightly soiled ovens or CONVOClean forte for normal to heavily soiled ovens
	<i>Fully automatic oven cleaning (CONVOClean system option)</i> on page 156	CONVOClean forte and CONVOCare
Fan compartment behind suction panel	<i>Semi-automatic oven cleaning</i> on page 153	CONVOClean new for slightly soiled ovens or CONVOClean forte for normal to heavily soiled ovens
	<i>Fully automatic oven cleaning (CONVOClean system option)</i> on page 156	CONVOClean forte and CONVOCare
Hygienic plug-in gasket around appliance door	<i>Cleaning the removable hygienic plug-in gasket</i> on page 188	Commercial detergent in the dishwasher
Oven drain	Rinse out to prevent blockage	With the hand shower
Demoisturising tray	<i>Cleaning the demoisturising tray</i> on page 192	CONVOClean new or CONVOClean forte
Drip tray in loading trolley (floor-standing appliances)	Empty and clean by hand	CONVOClean forte
Outside of appliance	Clean by hand with a soft cloth	Commercial stainless steel cleaner
Oven interior if a white deposit or dark discoloration is visible	In this case <ul style="list-style-type: none"> ▪ Spray on cleaner when oven is cold ▪ Leave to work for 10 minutes ▪ Polish with a soft, non-abrasive sponge ▪ Rinse out 	CONVOCare

Weekly cleaning tasks

The following table lists the cleaning tasks that you must perform weekly:

What must be cleaned?	Procedure	Cleaning agents
Interior double glass door	<i>Cleaning the double glass door</i> on page 186	Commercial glass cleaner
Bypass measuring hole	<i>Cleaning the bypass measuring hole</i> on page 189	CONVOClean new or CONVOClean forte
Door and appliance drip tray (table-top appliances) Door drain step (floor-standing appliances)	Clean by hand	CONVOClean new or CONVOClean forte
Armature (only for CONVOClean system option)	<i>Cleaning the armature</i> on page 196	CONVOClean forte
Fluff filter/fan, left side of oven floor	Clean by hand with a damp cloth	Commercial detergent

Monthly cleaning tasks

The following table lists the cleaning tasks that you must perform monthly:

What must be cleaned?	Procedure	Cleaning agents
Oven stand (option)	Clean by hand with a soft cloth	Commercial stainless steel cleaner

Carrying out maintenance tasks

You will need to carry out a few regular maintenance tasks yourself. Any more extensive maintenance tasks must only be performed by Customer Services.

Daily maintenance tasks that you must perform yourself

The following table lists the maintenance tasks that you must perform daily:

What must be serviced?	Procedure	Materials / tools
Steam generator (OEB & OGB only)	<i>Emptying and rinsing the steam generator on page 158</i>	Automatic
Water softener must be re-adjusted if you can see a white deposit inside the oven	Call customer service	-

Monthly maintenance tasks that you must perform yourself

The following table lists the maintenance tasks that you must perform monthly:

What must be serviced?	Procedure	Materials / tools
Rails on appliance door	Clean	-

Maintenance tasks that Customer Services must perform

The following table lists the maintenance tasks to be performed by the approved customer service engineer, and the service intervals between these tasks.

How often?	What must be serviced?
Yearly	General maintenance
When requested	Descaling the steam generator

More on this ...

How to do it correctly

□ Cleaning the double glass door.....	186
□ Cleaning the removable hygienic plug-in gasket	188
□ Cleaning the bypass measuring hole.....	189
□ Cleaning the demoinsturising tray.....	192
□ Cleaning the armature.....	196
□ Emptying the condensate collecting tray in the loading trolley	194

Related topics

□ Semi-automatic oven cleaning.....	153
□ Fully automatic oven cleaning (CONVOClean system option).....	156
□ Cleaning agents	160
□ Emptying and rinsing the steam generator	158
□ Descaling early warning (only on OEB)	159
□ Changing the cleaning canisters containing CONVOCare	198

▶ Semi-automatic oven cleaning

Cleaning agents

▲WARNING

Risk of skin and eye irritation or chemical burns

Direct contact with the CONVOClean new and CONVOCare cleaning agents will irritate the skin and eyes. Direct contact with CONVOClean forte will result in chemical burns.

- ▶ Do not inhale the spray mist.
- ▶ Do not let the cleaning agent come into contact with eyes or skin.
- ▶ Never open the appliance door during fully automatic cleaning.
- ▶ Wear protective gloves and safety goggles as specified in safety data sheet.

Skin burns

▲WARNING

Risk of skin burns

The CONVOClean forte cleaning agent will cause skin burns if there is any direct contact, and care must be exercised when handling the cleaning canisters.

- ▶ Do not inhale the spray mist.
- ▶ Do not let CONVOClean forte come into contact with eyes or skin.
- ▶ Never open the appliance door during fully automatic cleaning.
- ▶ Wear protective clothing, protective gloves and safety goggles as specified in safety regulations.

Requirements

Check that the following requirements have been met:

- You are already conversant with the operating steps listed under "How to do it correctly".

Materials required

You need the following materials:

- CONVOClean new or forte cleaning agent in the spray bottle

Using the spray bottle





Please follow this guidance when using the spray bottle:

- Never leave the spray bottle unused under pressure for prolonged periods. Open the pump head slowly to release the pressurized air.
- Rinse out the spray bottle weekly.
- Rinse out the nozzle, nozzle extension and nozzle pipe after each use.

Semi-automatic oven cleaning

For semi-automatic oven cleaning, follow the steps below:

Step	Action	Button
1	Remove the larger items of burnt food residues from the oven.	
2	Close the appliance door.	
3	Select the functions menu:	

Step	Action	Button
4	Use the tilt selector switch to choose the "semi-automatic cleaning" icon.	
5	Press the "Functions menu" button to confirm. Result: Semi-automatic cleaning starts.	
6	As soon as a signal sounds, remove the rack and suction panel.	
7	Spray inside the oven, including behind the suction panel, and into the drain in the floor using the spray bottle (1) of CONVOClean new or CONVOClean forte.	
8	Refit the suction panel and rack.	
9	Close the appliance door. Result: The program continues running automatically. If your combi steamer is an electric appliance, go to Step 11.	
10	If your combi steamer is a gas appliance, use the hand shower to rinse out behind the suction panel thoroughly as soon as you hear the next signal.	
11	Switch off the combi steamer as soon as you hear the next signal.	
12	Use the hand shower to rinse out thoroughly the oven interior, the fittings and the area behind the suction panel (2). For heavy soiling, you can repeat the cleaning program.	
13	Do not close the appliance door, but leave it just ajar.	

More on this ...

How to do it correctly

- Removing and fitting the racks (table-top appliances only) 169
- Removing and fitting the suction panel on table-top appliances..... 180

Related topics

- Cleaning agents 160
 - Cleaning and maintenance schedule 149
-

► Fully automatic oven cleaning (CONVOClean system option)

Requirements

Check that the following requirements have been met:

- For floor-standing appliances: the preheat bridge is fitted.
- No food has been left in the oven.
- The two canisters containing the cleaning agents have been connected correctly.
- The canisters contain enough fluid and the suction nozzle is in the fluid.
- You are already conversant with the operating steps listed under "How to do it correctly".







Materials required

You need the following materials:

- CONVOClean forte cleaning agent in a canister with a red label
- CONVOCare nozzle detergent in a canister with a green label
- Spray bottle containing CONVOClean new / forte cleaning agent for aftercare
- Spray bottle containing CONVOCare nozzle detergent for aftercare

Fully automatic oven cleaning

For fully automatic oven cleaning, follow the steps below:

Step	Action	Button
1	Turn the armature nozzle on the top of the oven through one complete turn to ensure that it moves freely.	
2	Remove the larger items of burnt food residues from the oven.	
3	Close the appliance door.	
4	Select the functions menu:	
5	Use the tilt selector switch to choose the "fully automatic cleaning" icon.	
6	Press the "Functions menu" button to confirm. Result: The Confirm menu appears in the display.	
7	Use the tilt selector switch to choose "YES".	 YES
8	Press the "Functions menu" button to confirm. Result: A selection menu appears in the display.	
9	Use the tilt selector switch to choose the soiling level. Q = quick clean 1 = light soiling 2 = normal soiling 3 = heavy soiling 4 = heavy soiling with Shine+	 Q, 1, 2, 3, 4
10	Press the "Functions menu" button to confirm. Result: CONVOClean system starts running.	

Step	Action	Button
11	<p>Open the appliance door when prompted by the system, ensure that the oven is empty and close the appliance door.</p> <p>Result: The combi steamer starts the CONVOClean <i>system</i>.</p> <p>Caution: Never interrupt this cycle. Do not open the appliance door.</p>	

Oven aftercare

For very heavy soiling, we recommend following this cycle with semi-automatic cleaning when you can target any remaining dirt.

Faults that may occur

The following table shows what faults might occur and the appropriate actions:

Fault	Action
"Not enough water" appears in display	Check the water supply.
"No cleaner pressure" appears in display	Check which canister is almost empty and re-fill it. In an emergency use water.
Power failure You have interrupted the fully automatic cleaning cycle.	If cleaning solutions have been used, the combi steamer will automatically rinse the oven before it can be operated.

More on this ...

Next steps

- Basic procedure for selecting extra functions and special programs.....78

How to do it correctly

- Inserting and removing the preheat bridge (floor-standing appliances only).....167
- Removing and fitting the suction panel on table-top appliances.....180
- Removing and fitting the racks (table-top appliances only)169
- Changing the cleaning canisters containing CONVOCare198

Related topics

- Cleaning the armature.....196
 - Semi-automatic oven cleaning153
 - Cleaning and maintenance schedule149
 - Cleaning agents160
-

▶ Emptying and rinsing the steam generator

Requirements







- Check that the following requirements have been met:
- You have an OEB or OGB appliance.

Materials required

- You need the following materials:
- None

Emptying and rinsing the steam generator

To empty and rinse the steam generator, follow the steps below:

Step	Action	Button
1	Switch on the combi steamer. Result: ▪ Self-test performed ▪ The oven light comes on.	
2	Press the "Functions menu" button. Result: The display shows the function icons.	
3	Use the tilt selector switch to choose the "Steam-generator rinse cycle" icon.	 
4	Press the "Functions menu" button to confirm. Result: A confirmation menu appears in the display.	
5	Use the tilt selector switch to choose "YES".	 YES
6	Press the "Functions menu" button to confirm. Result: The steam generator is emptied, rinsed, re-filled and heated. This process can take up to 5 minutes. The combi steamer is then ready for use.	

More on this ...

Related topics

- Cleaning and maintenance schedule 149

► Descaling early warning (only on OEB)

The principle

As soon as the appliance is switched on, it launches the continuous descaling check. Once the scale has reached a defined descaling level, a descaling warning is output, and is displayed once the appliance is in the Stop state (switched on but not running a cooking program).

You can continue to operate the appliance as normal. The display is merely a warning.

The threshold for the descaling level is adjustable, and can be changed by an approved customer service engineer or specially trained personnel.

The display looks like this

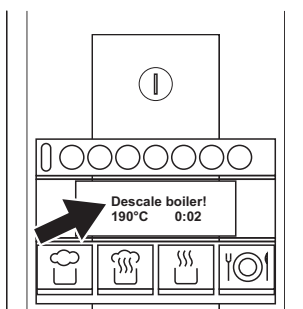

Descal the steam generator

Notify your approved customer service engineer or a trained member of staff to descale the steam generator.

More on this ...

Related topics

- Cleaning and maintenance schedule 149
-

▶ Cleaning agents

Cleaning agents

Use only original cleaning agents to clean the oven interior.

Please note:

Damage caused as a result of improper cleaning without using the specified cleaning agents will invalidate any warranty claims.

The table below lists the original cleaning agents available, where they are used and what container they are kept in:

Product	Use	Container
CONVOclean new Eco-friendly detergent for light soiling (not for fully automatic oven cleaning)	Cleaning inside the oven <ul style="list-style-type: none"> ▪ by hand ▪ semi-automatic 	Spray bottle
CONVOclean forte Eco-friendly detergent for normal to heavy soiling	Cleaning inside the oven <ul style="list-style-type: none"> ▪ by hand ▪ semi-automatic 	Spray bottle
	Cleaning inside the oven <ul style="list-style-type: none"> ▪ fully automatic 	Canisters attached to the cleaning system or cleaning shelves under the combi steamer
CONVOCare nozzle detergent	Cleaning inside the oven <ul style="list-style-type: none"> ▪ fully automatic 	Canisters attached to the cleaning system or cleaning shelves under the combi steamer
	Manual aftercare of oven interior	Spray bottle
Stainless steel cleaning spray	Caring for the external surfaces of the combi steamer	-
Stainless steel cleaner	Caring for the external surfaces of the combi steamer	-

Using cleaning agents

You must wear protective gear as specified in *Personal protection equipment* on page 49 when using cleaning agents.

Follow guidance on EU safety datasheets.

Staff are to be trained regularly by the owner of the combi steamer.

▶ Troubleshooting

Errors and required responses

The following table explains the error codes used in the display:

Error code	Description of fault	Required response
E01.0	OEB/OGB: Not enough water in the steam generator OES/OGS: Not enough water	1. Open the water supply 2. Contact customer service
E01.1	Level reached too slowly: Steam generator filling time is too long	1. Open the water supply 2. Contact customer service
E02.0	Wiring compartment too hot:	1. Clean fluff filter (oven floor) 2. Clear air intake in base of appliance 3. Contact customer service
E03.0	Fan fault / Motor thermal protection (thermal cutout) has tripped or fault in frequency converter	1. Check fuse in building 2. Contact customer service
E04.0	Fault in secondary fan: Secondary-fan fault in electrical compartment	1. Clean fluff filter (oven floor) 2. Clear air intake in base of appliance 3. Contact customer service
E05.x	No gas	1. Open the gas tap 2. Let the gas pipe fill (start 2x convection) 3. Contact customer service
E11.0	Oven sensor is reading too high a temperature	Contact customer service
E12.1	Core temperature sensor is reading too high	Correct the sensor position
E12.2		
E12.3		
E12.4		
E13.0	Steam generator sensor is reading too high a temperature	1. Rinse out steam generator 2. Contact customer service
E14.0	Bypass sensor is reading too high a temperature	1. Check water supply 2. Contact customer service
E15.0	Condenser sensor is reading too high a temperature	1. Open the water supply 2. Contact customer service
E21.0	Oven sensor (B6) open circuit	Contact customer service
E21.1	Oven sensor (B6) has a ground fault	Contact customer service
E22.1	Core temperature sensor (CTS) open circuit	Contact customer service
E22.2		
E22.3		
E22.4		
E23.0	Steam generator sensor (B4) open circuit	Contact customer service
E23.1	Steam generator sensor (B4) has a ground fault	Contact customer service
E24.0	Bypass sensor (B5) disconnected	Contact customer service
E24.1	Bypass sensor (B5) has a ground fault	Contact customer service

Error code	Description of fault	Required response
E25.0	Condenser sensor (B3) open circuit	Contact customer service
E25.1	Condenser sensor (B3) has a ground fault	Contact customer service
E26.0	Thermal cutout (B8) open circuit	Contact customer service
E26.1	Thermal cutout (B8) has a ground fault	Contact customer service
E27.0	Thermal cutout (B8) is reading too high a temperature	Contact customer service
E29.1 E29.2 E29.3 E29.4	Core temperature sensor (CTS) has a ground fault	Contact customer service
E33.0	Steam generator malfunction	Get customer service to test and reset the thermal cutout N7
E34.0	Steam-generator pump fault: pump does not turn on	1. Unplug the appliance for approx. 10 seconds and restart 2. Disable steam generator rinsing and contact customer service
E83.0	Inadmissible cooking function	1. Re-enter the cooking program 2. Contact customer service
E89.1	Invalid data in the identification module (IDM)	1. Unplug the appliance for approx. 10 seconds and restart 2. Contact customer service
E96.0	Communications error	1. Unplug the appliance for approx. 10 seconds and restart 2. Contact customer service
E99.x	General initialization error	Unplug the appliance for approx. 10 seconds and restart

▶ Rectifying faults - Irregularities during operation

Errors and required responses

The following table contains a list of possible irregularities during operation and how to rectify them:

Irregularity	Possible cause	Required response / Further details ...
Uneven browning	Suction panel not closed correctly	<i>Removing and fitting the suction panel on page 180</i>
	Air guide panel not fitted correctly or not fitted at all	<i>Fixing the air guide panel to the rack</i>
	Oven temperature too high	Select a lower oven temperature and extend the cooking time
	Bypass clogged with grease	<i>Cleaning the bypass measuring hole on page 189</i> Contact customer service if necessary
Appliance does not respond to any input for 10-20 seconds	Software has crashed	Press ON/OFF for 5 seconds or disconnect the appliance from the mains supply for 5 seconds
No longer able to switch the appliance on or off	ON/OFF is blocked for 3 seconds	Try again after 3 seconds.
Water runs out underneath the appliance when closing the door	Whatever the cause	Caution: risk of contamination: Discard any food that has come into contact with this water.
	Complete or partial blockage of waste water pipe	Check customer's drain system and clean if necessary
	Permanent drain connection on appliances with CONVOClean system	Use permanent connection if applicable
	Bypass clogged	<i>Cleaning the bypass measuring hole on page 189</i>
	Air vent blocked or covered	Remove obstruction
Appliance drain clogged	Clean out the drain	
Water is being sprayed into the oven compartment during operation	Automatic steam generator rinse program has not been run every day	<i>Emptying and rinsing the steam generator on page 158</i>
Water standing in oven compartment	Appliance drain clogged	Rinse out the drain
Black marks in the oven compartment	Incorrect cleaning agent	Use CONVOClean forte for automatic cleaning Use CONVOClean forte or CONVOClean new for semi-automatic cleaning
	Water too hard	<i>Adjusting the water hardness on page 22, on page 29, on page 33, on page 26</i>
Poor cleaning result	Water pressure too low	Testing the water pressure If necessary, increase the customer's water pressure
	Incorrect soiling level set	Select a higher cleaning level
	Incorrect cleaning agent used	Use CONVOClean forte for automatic cleaning Use CONVOClean forte or CONVOClean new for semi-automatic cleaning

9 How to do it correctly

Main handling operations for the combi steamer

This chapter describes how to perform some of the main repetitive handling tasks that will arise when operating the combi steamer.

Contents

This chapter contains the following topics:

	Page
Opening the appliance door safely	165
Inserting and removing the preheat bridge (floor-standing appliances only)	167
Removing and fitting the racks (table-top appliances only)	169
Loading table-top appliances / removing food from table-top appliances	170
Loading table-top appliances using the transport trolley	172
Loading floor-standing appliances	176
Stowing away the core temperature sensor for table-top appliances	178
Stowing away the core temperature sensor for floor-standing appliances	179
Removing and fitting the suction panel on table-top appliances	180
Removing and fitting the suction panel on floor-standing appliances	182
Grill version (only for table-top appliances)	184
Cleaning the double glass door	186
Cleaning the removable hygienic plug-in gasket	188
Cleaning the bypass measuring hole	189
Cleaning the demoinsturising tray	192
Emptying the condensate collecting tray in the loading trolley	194
Cleaning the armature	196
Changing the cleaning canisters containing CONVOClean forte	197
Changing the cleaning canisters containing CONVOCare	198

▶ Opening the appliance door safely

Hot surfaces

⚠ WARNING

Risk of burns from high temperatures inside the oven and on the inside of the appliance door

You may get burnt if you touch any of the interior parts of the oven, the inside of the appliance door or any parts that were inside the oven during cooking.

- ▶ Wear personal protection equipment as specified in safety regulations.

Hot steam / vapor

⚠ WARNING



Risk of scalding from hot steam and vapor

Escaping hot steam and vapor can cause scalding to face, hands, feet and legs.

- ▶ Open the appliance door as specified in the user manual. Never put your head into the oven!
- ▶ For floor-standing appliances, insert the preheat bridge if there is no loading trolley in the combi steamer during preheating.

Opening the appliance door safely

To open the appliance door, follow the steps below:

Step	Action	Illustration
1	Move the handle into a horizontal position (1) and wait for a moment to allow steam to escape.	
2	Turn the door handle further upwards (2) and open the door slowly.	

How to do it correctly

Step	Action	Illustration
3	Open the door (2) and slide it back (3) along the side of the combi steamer.	 The illustration shows a stainless steel combi steamer with its door open. A blue arrow labeled '2' points to the door handle, indicating the opening action. Another blue arrow labeled '3' points to the door's edge, indicating it should be slid back along the side of the unit. The interior of the steamer is visible, showing several metal trays.

▶ Inserting and removing the preheat bridge (floor-standing appliances only)

Hot surfaces

⚠ WARNING

Risk of burns from high temperatures inside the oven and on the inside of the appliance door

You may get burnt if you touch any of the interior parts of the oven, the inside of the appliance door or any parts that were inside the oven during cooking.

- ▶ Wear personal protection equipment as specified in safety regulations.



Purpose of the preheat bridge

The preheat bridge is required in floor-standing appliances for the following procedures:

- When preheating without loading trolley, because escaping hot steam may otherwise scald feet and legs.
- During automatic cleaning without the loading trolley, because otherwise cleaning agent or steam may escape.

Insert preheat bridge

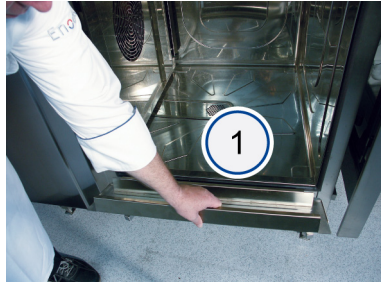
To insert the preheat bridge, follow the steps below:

Step	Action	Illustration
1	Attach the preheat bridge (1).	
2	Swing the preheat bridge up (2).	

Removing the preheat bridge

To remove the preheat bridge, follow the steps below:

Step	Action	Illustration
1	Use the handle of the loading trolley to remove the preheat bridge.	 A photograph showing a person's hand in a white sleeve using a metal handle to lift a blue and white patterned preheat bridge from a dark-colored machine. The machine has a loading trolley structure.

More on this ...

Related topics

□ Loading floor-standing appliances	176
---	-----

▶ Removing and fitting the racks (table-top appliances only)

Hot surfaces

⚠WARNING



Risk of burns from high temperatures inside the oven and on the inside of the appliance door

You may get burnt if you touch any of the interior parts of the oven, the inside of the appliance door or any parts that were inside the oven during cooking.

- ▶ Wear personal protection equipment as specified in safety regulations.

Removing racks

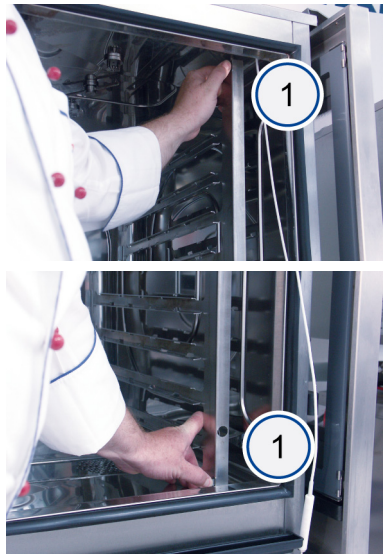
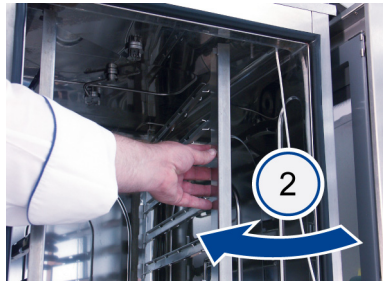
To remove a rack, follow the steps below:

Step	Action	Illustration
1	Release the clips at the top and bottom (1).	
2	Swing the rack into the oven (2).	
3	Push the rack upwards and remove it (3). Caution: Take care not to bend the rails, otherwise shelf-grills, baking trays and containers will no longer be held securely.	

Fitting racks

To fit a rack, follow the steps in the reverse order.

▶ Loading table-top appliances / removing food from table-top appliances

Hot surfaces

▲WARNING

Risk of burns from high temperatures inside the oven and on the inside of the appliance door

You may get burnt if you touch any of the interior parts of the oven, the inside of the appliance door or any parts that were inside the oven during cooking.

- ▶ Wear personal protection equipment as specified in safety regulations.

Hot steam / vapor

▲WARNING

Risk of scalding from hot steam and vapor

Escaping hot steam and vapor can cause scalding to face, hands, feet and legs.

- ▶ Open the appliance door as specified in the user manual. Never put your head into the oven!
- ▶ For floor-standing appliances, insert the preheat bridge if there is no loading trolley in the combi steamer during preheating.

Hot liquids

▲WARNING

Risk of scalding from hot liquids

Spilling liquid foods can result in scalds to face and hands.

- ▶ Those containers holding liquids or food that will liquefy during cooking must only be placed on shelves that are below a height of 1.60 m, indicated by the warning sign "Hot Liquids" on the appliance or loading trolley. Only these shelves can be seen by all users.
- ▶ During loading, make sure that the racks are fixed in place properly.
- ▶ Insert the containers correctly into the U-rail of the rack. Do not place containers on the top rail.
- ▶ Engage the transport securing mechanism of the shelf rack on the transport trolley.
- ▶ During movement, cover containers holding hot liquids.
- ▶ Always cover hot liquids when conveying them on the transport trolley or loading trolley.
- ▶ Take care not to tilt the transport trolley carrying the shelf rack, or the loading trolley.



Requirements

Check that the following requirements have been met:

- You are already conversant with the operating steps listed under "How to do it correctly".

Loading

To load the oven, follow the steps below:

Step	Action	Illustration
1	Open the appliance door (1).	
2	Place the food onto the required shelf levels (2). WARNING Please note that containers holding liquids or food that will liquefy during cooking must be placed on shelf levels that allow a proper view inside the container.	

Removing food

To remove the food, follow the steps below:

Step	Action
1	Open the appliance door.
2	Hold the food horizontally when removing it.

More on this ...

How to do it correctly

- Opening the appliance door safely 165

Related topics

- Loading table-top appliances using the transport trolley..... 172
-

▶ Loading table-top appliances using the transport trolley

Hot surfaces

▲WARNING

Risk of burns from high temperatures inside the oven and on the inside of the appliance door

You may get burnt if you touch any of the interior parts of the oven, the inside of the appliance door or any parts that were inside the oven during cooking.

- ▶ Wear personal protection equipment as specified in safety regulations.

Hot steam / vapor

▲WARNING

Risk of scalding from hot steam and vapor

Escaping hot steam and vapor can cause scalding to face, hands, feet and legs.

- ▶ Open the appliance door as specified in the user manual. Never put your head into the oven!
- ▶ For floor-standing appliances, insert the preheat bridge if there is no loading trolley in the combi steamer during preheating.

Hot liquids

▲WARNING

Risk of scalding from hot liquids

Spilling liquid foods can result in scalds to face and hands.

- ▶ Those containers holding liquids or food that will liquefy during cooking must only be placed on shelves that are below a height of 1.60 m, indicated by the warning sign "Hot Liquids" on the appliance or loading trolley. Only these shelves can be seen by all users.
- ▶ During loading, make sure that the racks are fixed in place properly.
- ▶ Insert the containers correctly into the U-rail of the rack. Do not place containers on the top rail.
- ▶ Engage the transport securing mechanism of the shelf rack on the transport trolley.
- ▶ During movement, cover containers holding hot liquids.
- ▶ Always cover hot liquids when conveying them on the transport trolley or loading trolley.
- ▶ Take care not to tilt the transport trolley carrying the shelf rack, or the loading trolley.

Requirements

Check that the following requirements have been met:

- You are already conversant with the operating steps listed under "How to do it correctly".



Accessories required

You need the following accessories:

- Transport trolley
- Shelf rack or plate rack
- Slide-in frame

Loading using the transport trolley

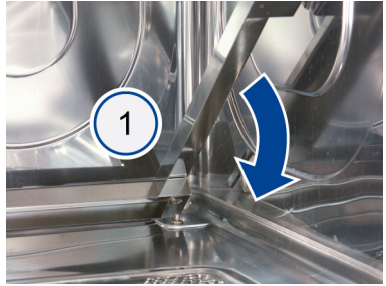
To load the oven using the transport trolley, follow the steps below:

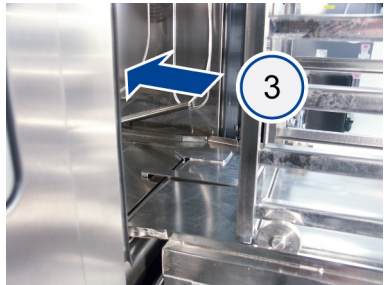
Step	Action	Illustration
1	Remove the rack.	
2	Secure the slide-in frame (1) and attach it to the floor of the appliance.	
3	Position the shelf rack on the transport trolley.	
4	Engage the transport securing mechanism.	
5	Load shelf rack with food. WARNING Please note that containers holding liquids or food that will liquefy during cooking must be placed on shelf levels that allow a proper view inside the container.	
6	Open the appliance door.	
7	Fix the transport trolley onto the combi steamer (2) and engage the handbrake.	
8	Slide the shelf rack into the oven (3).	

How to do it correctly

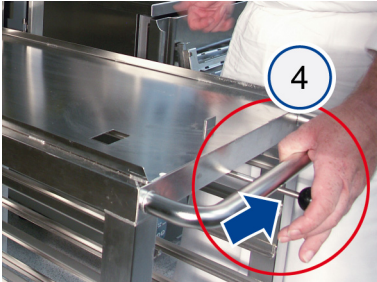
Step	Action	Illustration
9	Release the fastener (4) and move the transport trolley away from the appliance.	 A close-up photograph of a person's hand in a white uniform sleeve interacting with a metal transport trolley. The hand is positioned to release a fastener, which is highlighted by a red circle and labeled with the number '4' in a white circle. A blue arrow points to the fastener. The trolley is attached to a stainless steel appliance.
10	Close the appliance door.	

Removing food

You can either remove the containers individually or use the transport trolley.

To remove food using the transport trolley, follow the steps below:

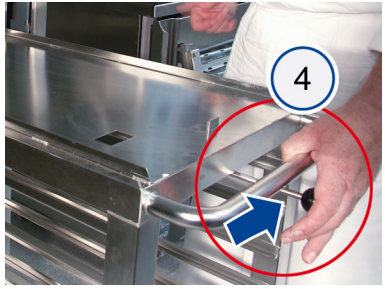
Step	Action	Illustration
1	Open the appliance door.	
2	Fix the transport trolley onto the combi steamer (2) and engage the handbrake.	
3	Pull the shelf rack onto the transport trolley.	
4	Engage the transport securing mechanism. WARNING If the transport securing mechanism is not engaged, the shelf rack may tip off the trolley.	
5	Release the fastener (4) and move the transport trolley away from the appliance.	
6	Remove the cooked product from the transport trolley.	

More on this ...

How to do it correctly

- Opening the appliance door safely 165
- Removing and fitting the racks (table-top appliances only) 169

Related topics

- Loading table-top appliances / removing food from table-top appliances..... 170
-

▶ Loading floor-standing appliances

Hot surfaces

▲WARNING

Risk of burns from high temperatures inside the oven and on the inside of the appliance door

You may get burnt if you touch any of the interior parts of the oven, the inside of the appliance door or any parts that were inside the oven during cooking.

- ▶ Wear personal protection equipment as specified in safety regulations.

Hot steam / vapor

▲WARNING

Risk of scalding from hot steam and vapor

Escaping hot steam and vapor can cause scalding to face, hands, feet and legs.

- ▶ Open the appliance door as specified in the user manual. Never put your head into the oven!
- ▶ For floor-standing appliances, insert the preheat bridge if there is no loading trolley in the combi steamer during preheating.

Hot liquids

▲WARNING

Risk of scalding from hot liquids

Spilling liquid foods can result in scalds to face and hands.

- ▶ Those containers holding liquids or food that will liquefy during cooking must only be placed on shelves that are below a height of 1.60 m, indicated by the warning sign "Hot Liquids" on the appliance or loading trolley. Only these shelves can be seen by all users.
- ▶ During loading, make sure that the racks are fixed in place properly.
- ▶ Insert the containers correctly into the U-rail of the rack. Do not place containers on the top rail.
- ▶ Engage the transport securing mechanism of the shelf rack on the transport trolley.
- ▶ During movement, cover containers holding hot liquids.
- ▶ Always cover hot liquids when conveying them on the transport trolley or loading trolley.
- ▶ Take care not to tilt the transport trolley carrying the shelf rack, or the loading trolley.

Requirements

Check that the following requirements have been met:

- You are already conversant with the operating steps listed under "How to do it correctly".

Loading floor-standing appliances using the loading trolley

To load the oven using the loading trolley, follow the steps below:

Step	Action	Illustration
1	Place food on loading trolley. WARNING Please note that containers holding liquids or food that will liquefy during cooking must be placed on shelf levels that allow a proper view inside the container.	
2	Open the appliance door.	
3	Remove the preheat bridge.	
4	Push the loading trolley in as far as it will go (1). Caution: Risk of hands being pinched. Use the handle.	
5	Remove the handle and hang it on the left-hand side wall.	
6	Close the appliance door.	
7	Lock the wheels of the loading trolley (2).	

Removing food

To remove the food, follow the steps below:

Step	Action	Illustration
1	Open the appliance door.	
2	Release the wheel lock.	
3	Attach the handle and pull the trolley out.	
4	Close the appliance door.	

More on this ...

How to do it correctly

- Opening the appliance door safely 165
 - Inserting and removing the preheat bridge (floor-standing appliances only) 167
-

► Stowing away the core temperature sensor for table-top appliances

Hot surfaces

▲WARNING

Risk of burns from high temperatures inside the oven and on the inside of the appliance door

You may get burnt if you touch any of the interior parts of the oven, the inside of the appliance door or any parts that were inside the oven during cooking.

- Wear personal protection equipment as specified in safety regulations.

Purpose

The core temperature sensor must be stowed away when it is not needed for the cooking process. Otherwise the sensor risks getting damaged.

Requirements

Check that the following requirements have been met:

- You are already conversant with the operating steps listed under "How to do it correctly".

Stowing away

Follow the steps below to stow away the core temperature sensor:

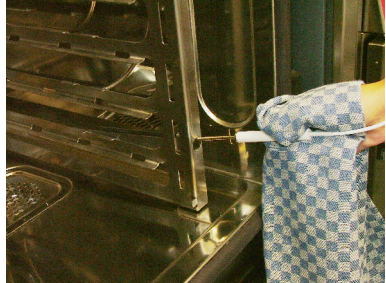
Step	Action	Illustration
1	Slide the sensor into the hole in the rack.	

More on this ...

How to do it correctly

<input type="checkbox"/> Loading table-top appliances using the transport trolley.....	172
<input type="checkbox"/> Opening the appliance door safely	165
<input type="checkbox"/> Loading table-top appliances / removing food from table-top appliances.....	170
<input type="checkbox"/> Loading floor-standing appliances	176

▶ Stowing away the core temperature sensor for floor-standing appliances

Hot surfaces

⚠ WARNING

Risk of burns from high temperatures inside the oven and on the inside of the appliance door

You may get burnt if you touch any of the interior parts of the oven, the inside of the appliance door or any parts that were inside the oven during cooking.

- ▶ Wear personal protection equipment as specified in safety regulations.

Purpose

The core temperature sensor must be stowed away when it is not needed for the cooking process. Otherwise the sensor risks getting damaged.

Requirements

Check that the following requirements have been met:

- You are already conversant with the operating steps listed under "How to do it correctly".

Stowing away

Follow the steps below to stow away the core temperature sensor:

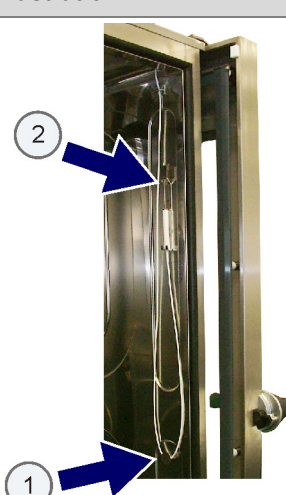
Step	Action	Illustration
1	Wind the cable from the core temperature sensor around the cable-tidy (1).	
2	Slide the sensor into the holder (2).	

More on this ...

How to do it correctly

□ Loading table-top appliances using the transport trolley.....	172
□ Opening the appliance door safely	165
□ Loading table-top appliances / removing food from table-top appliances.....	170
□ Loading floor-standing appliances	176

► Removing and fitting the suction panel on table-top appliances

Hot surfaces

⚠WARNING

Risk of burns from high temperatures inside the oven and on the inside of the appliance door

You may get burnt if you touch any of the interior parts of the oven, the inside of the appliance door or any parts that were inside the oven during cooking.

- Wear personal protection equipment as specified in safety regulations.



Materials required

You need the following materials:

- Suitable tool for undoing the screws e.g. wrench

Removing the suction panel

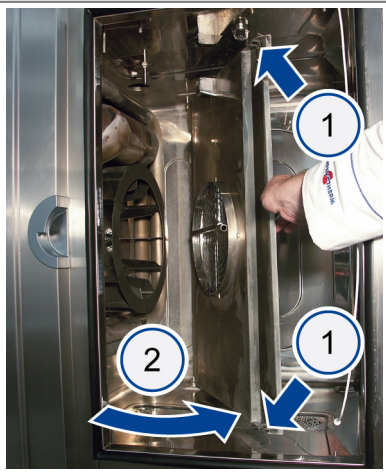
To remove the suction panel, follow the steps below:

Step	Action	Illustration
1	Release the catches, top (1) and bottom (1), using the tool, and hinge out the suction panel into the oven (2).	
2	Push the suction panel upwards and remove it (3).	

Fitting the suction panel

To fit the suction panel, follow the steps in the reverse order.

More on this ...

Related topics

□ Cleaning and maintenance schedule	149
□ Cleaning agents	160
□ Cleaning the removable hygienic plug-in gasket	188
□ Cleaning the bypass measuring hole	189
□ Cleaning the demisting tray	192
□ Changing the cleaning canisters containing CONVOCare	198

▶ Removing and fitting the suction panel on floor-standing appliances

Hot surfaces

▲WARNING

Risk of burns from high temperatures inside the oven and on the inside of the appliance door

You may get burnt if you touch any of the interior parts of the oven, the inside of the appliance door or any parts that were inside the oven during cooking.

- ▶ Wear personal protection equipment as specified in safety regulations.

Materials required

You need the following materials:

- Suitable tool for undoing the screws e.g. wrench

Removing the suction panel

To remove the suction panel, follow the steps below:

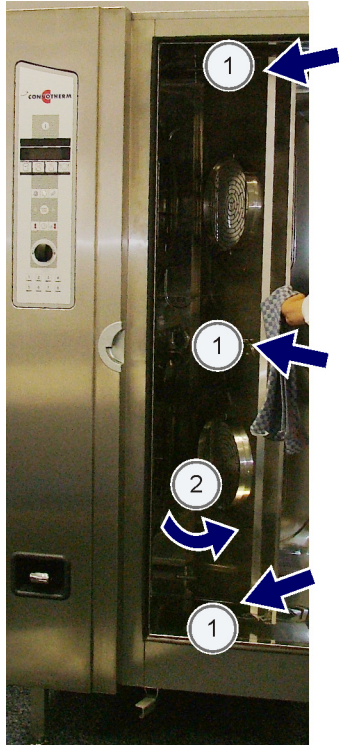
Step	Action	Illustration
1	Release the catches, top (1), center (1) and bottom (1), using the tool, and hinge out the suction panel into the oven (2).	

Step	Action	Illustration
2	Push the suction panel upwards and remove it (3).	

Fitting the suction panel

To fit the suction panel, follow the steps in the reverse order.

More on this ...

Related topics

<input type="checkbox"/> Cleaning agents	160
<input type="checkbox"/> Cleaning the bypass measuring hole	189
<input type="checkbox"/> Cleaning the demisting tray	192
<input type="checkbox"/> Changing the cleaning canisters containing CONVOCare	198
<input type="checkbox"/> Cleaning the removable hygienic plug-in gasket	188
<input type="checkbox"/> Cleaning and maintenance schedule	149

▶ Grill version (only for table-top appliances)

Restrictions on use

The following restrictions on use must be observed:

When the plug in the fat drain outlet is unscrewed, it is not permitted to operate the appliance as follows:

- Without a fixed connection to the fat drain outlet
- With the fluid running off into an open container beneath the appliance
- Without an initial amount of fluid in the fat collecting container



Requirements

Check that the following requirements have been met:

- You are already conversant with the operating steps listed under "How to do it correctly".

Preparing the grill version

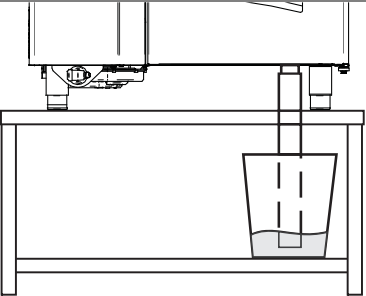
Follow the steps below to prepare the grill version:

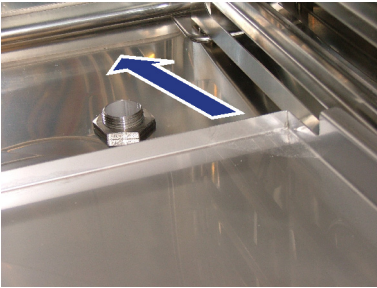
Step	Action	Illustration
1	<p>Fill the fat collecting container with about 5 cm of water so that the tube mouth lies under the surface of the water. Make sure that the fat can drain freely into the fat collecting container.</p> <p>Caution: It is essential that the fat collecting container always contains water (above the level of the tube mouth). Otherwise the closed system inside the oven is unable to work.</p>	
2	<p>Unscrew the plug from the drain outlet in the appliance base.</p>	
3	<p>Slide the fat collecting tray into the appliance.</p> <p>Caution: The drain from the fat collecting tray must lie over the center of the fat drain outlet in the oven floor.</p>	
4	<p>The grill version is now ready for use.</p>	
5	<p>When grilling, use the intermediate plates to prevent the seasoning being washed off by dripping fat.</p>	

Cleaning the grill version

To clean the grill version, follow the steps below:

Step	Action
1	Remove the fat collecting tray from the oven compartment.
2	Close the plug on the fat drain outlet in the appliance base.
3	You can now perform the following jobs: <ul style="list-style-type: none">▪ semi-automatic cleaning▪ automatic cleaning▪ steam-generator rinse program (automatic or manual)▪ rinsing out the oven compartment with the hand shower

More on this ...

How to do it correctly

<input type="checkbox"/> Loading table-top appliances using the transport trolley.....	172
<input type="checkbox"/> Opening the appliance door safely	165
<input type="checkbox"/> Loading table-top appliances / removing food from table-top appliances.....	170
<input type="checkbox"/> Loading floor-standing appliances	176

▶ **Cleaning the double glass door**

Hot steam

▲WARNING

Risk of scalding from hot steam

If water is sprayed into the hot oven using the hand shower, steam will be produced that may scald.

- ▶ Do not clean until the oven interior has cooled to below 60 °C.

Electric shock

▲DANGER

Risk of electric shock from live parts

Water on the exterior of the combi steamer can cause a short-circuit, which may result in electric shock on touching the combi steamer.

- ▶ Do not spray the exterior of the combi steamer with water.
- ▶ Protect from rain if operated outdoors.

Risk of crushing

▲CAUTION

Risk of hand injuries from crushing

When cleaning the appliance door and interior door there is the risk that you will crush your hand.

- ▶ Take care not to place your hand between door and end stop on the right-hand side of the appliance door or interior door.

Materials required

You need the following materials:

- Commercial glass cleaner

Cleaning the double glass door

To clean the double glass door, follow the steps below:

Step	Action	Illustration
1	Open the quick-release catch on the double glass door (1).	
2	Clean the double glass door with glass cleaner. Take care not to scratch the glass.	
3	Re-close the double glass door using the quick-release catch (1).	

More on this ...

Related topics

<input type="checkbox"/> Cleaning agents	160
<input type="checkbox"/> Cleaning the removable hygienic plug-in gasket	188
<input type="checkbox"/> Cleaning the bypass measuring hole	189
<input type="checkbox"/> Cleaning the demisting tray	192
<input type="checkbox"/> Cleaning the armature	196

► Cleaning the removable hygienic plug-in gasket

Hot steam

▲WARNING

Risk of scalding from hot steam

If water is sprayed into the hot oven using the hand shower, steam will be produced that may scald.

- ▶ Do not clean until the oven interior has cooled to below 60 °C.

Electric shock

▲DANGER

Risk of electric shock from live parts

Water on the exterior of the combi steamer can cause a short-circuit, which may result in electric shock on touching the combi steamer.

- ▶ Do not spray the exterior of the combi steamer with water.
- ▶ Protect from rain if operated outdoors.

Materials required

You need the following materials:

- commercial, mild, odorless detergent
- soft cloth
- no tools

Cleaning the removable hygienic plug-in gasket

To clean the removable hygienic plug-in gasket, follow the steps below:

Step	Action	Illustration
1	Pull off the hygienic seal from around the appliance door, starting from the corners.	
2	Clean the hygienic plug-in gasket with detergent.	
3	Dry the hygienic plug-in gasket thoroughly.	
4	Refit the hygienic plug-in gasket, starting from the corners.	

More on this ...

Related topics

□ Cleaning agents	160
□ Cleaning the double glass door.....	186
□ Cleaning the bypass measuring hole	189
□ Cleaning the demoinsturising tray.....	192
□ Cleaning the armature.....	196

► Cleaning the bypass measuring hole

Hot steam

▲WARNING

Risk of scalding from hot steam

If water is sprayed into the hot oven using the hand shower, steam will be produced that may scald.

- ▶ Do not clean until the oven interior has cooled to below 60 °C.

Cleaning agents

▲WARNING

Risk of skin and eye irritation or chemical burns

Direct contact with the CONVOClean new and CONVOCare cleaning agents will irritate the skin and eyes. Direct contact with CONVOClean forte will result in chemical burns.

- ▶ Do not inhale the spray mist.
- ▶ Do not let the cleaning agent come into contact with eyes or skin.
- ▶ Never open the appliance door during fully automatic cleaning.
- ▶ Wear protective gloves and safety goggles as specified in safety data sheet.

Skin burns

▲WARNING

Risk of skin burns

The CONVOClean forte cleaning agent will cause skin burns if there is any direct contact, and care must be exercised when handling the cleaning canisters.

- ▶ Do not inhale the spray mist.
- ▶ Do not let CONVOClean forte come into contact with eyes or skin.
- ▶ Never open the appliance door during fully automatic cleaning.
- ▶ Wear protective clothing, protective gloves and safety goggles as specified in safety regulations.

Electric shock

▲DANGER

Risk of electric shock from live parts

Water on the exterior of the combi steamer can cause a short-circuit, which may result in electric shock on touching the combi steamer.

- ▶ Do not spray the exterior of the combi steamer with water.
- ▶ Protect from rain if operated outdoors.

Requirements

Check that the following requirements have been met:

- You are already conversant with the operating steps listed under "How to do it correctly".

Materials required

You need the following materials:

- CONVOClean forte cleaning agent in the spray bottle
- Bottle brush



Using the spray bottle

Please follow this guidance when using the spray bottle:

- Never leave the spray bottle unused under pressure for prolonged periods. Open the pump head slowly to release the pressurized air.
- Rinse out the spray bottle weekly.
- Rinse out the nozzle, nozzle extension and nozzle pipe after each use.

Cleaning the bypass measuring hole

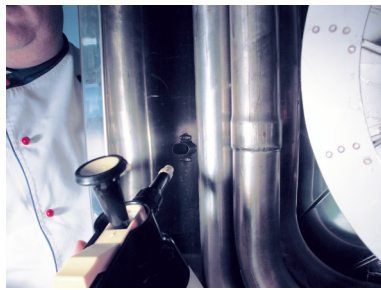
To clean the bypass measuring hole, follow the steps below:

Step	Action	Illustration
1	Remove the suction panel or hinge it down.	
2	Spray the bypass measuring hole with CONVOClean forte.	
3	Use the bottle brush to clean the bypass measuring hole.	
4	Rinse off with the hand shower.	
5	Refit the suction panel.	
6	Do not close the appliance door, but leave it ajar.	

More on this ...

How to do it correctly

- Removing and fitting the suction panel on table-top appliances..... 180

Related topics

- Cleaning agents 160
 - Cleaning the double glass door..... 186
 - Cleaning the removable hygienic plug-in gasket 188
 - Cleaning the demohstrising tray..... 192
 - Cleaning the armature..... 196
-

► Cleaning the demineralising tray

Cleaning agents

▲WARNING

Risk of skin and eye irritation or chemical burns

Direct contact with the CONVOClean new and CONVOCare cleaning agents will irritate the skin and eyes. Direct contact with CONVOClean forte will result in chemical burns.

- ▶ Do not inhale the spray mist.
- ▶ Do not let the cleaning agent come into contact with eyes or skin.
- ▶ Never open the appliance door during fully automatic cleaning.
- ▶ Wear protective gloves and safety goggles as specified in safety data sheet.

Skin burns

▲WARNING

Risk of skin burns

The CONVOClean forte cleaning agent will cause skin burns if there is any direct contact, and care must be exercised when handling the cleaning canisters.

- ▶ Do not inhale the spray mist.
- ▶ Do not let CONVOClean forte come into contact with eyes or skin.
- ▶ Never open the appliance door during fully automatic cleaning.
- ▶ Wear protective clothing, protective gloves and safety goggles as specified in safety regulations.

Hot surfaces

▲WARNING

Risk of burns from high temperatures inside the oven and on the inside of the appliance door

You may get burnt if you touch any of the interior parts of the oven, the inside of the appliance door or any parts that were inside the oven during cooking.

- ▶ Wear personal protection equipment as specified in safety regulations.

Requirements

Check that the following requirements have been met:

- You are already conversant with the operating steps listed under "How to do it correctly".

Materials required

You need the following materials:

- CONVOClean new / forte cleaning agent in the spray bottle

Caution: never use any other cleaning agent.

Using the spray bottle

Please follow this guidance when using the spray bottle:

- Never leave the spray bottle unused under pressure for prolonged periods. Open the pump head slowly to release the pressurized air.
- Rinse out the spray bottle weekly.
- Rinse out the nozzle, nozzle extension and nozzle pipe after each use.

Cleaning the demoinsturising tray

To clean the demoinsturising tray, follow the steps below:

Step	Action	Illustration
1	Remove the suction panel or hinge it down.	
2	Take the cover off the demoinsturising tray.	
3	Clean the demoinsturising tray and outflow of any food residues.	
4	Spray the demoinsturising tray and cover with CONVOClean new / forte and leave it to take effect.	
5	Rinse off the demoinsturising tray and the cover using the hand shower.	
6	Replace the cover on the demoinsturising tray.	
7	Refit the suction panel or hinge it back up.	
8	Do not close the appliance door, but leave it ajar.	

More on this ...

How to do it correctly

- Removing and fitting the suction panel on table-top appliances..... 180

Related topics

- Cleaning agents 160
 - Cleaning the double glass door..... 186
 - Cleaning the removable hygienic plug-in gasket 188
 - Cleaning the bypass measuring hole 189
 - Cleaning the armature..... 196
-

▶ Emptying the condensate collecting tray in the loading trolley

Hot liquids

⚠ WARNING

Risk of scalding from hot liquids

Spilling a hot liquid can result in scalds to hands and feet.

- ▶ Let the liquid cool down in the condensate collecting tray before emptying the condensate collecting tray.

Hot surfaces

⚠ WARNING

Risk of burns from high temperatures of the loading trolley

Touching the loading trolley immediately after cooking operation can result in burns.

- ▶ Wear personal protection equipment as specified in safety regulations.



Requirements

Check that the following requirements have been met:

- Condensate collecting tray is full.
- Loading trolley is not holding any food and has been removed from the oven.
- You are already conversant with the operating steps listed under "How to do it correctly".

Emptying the condensate collecting tray into the drain gully

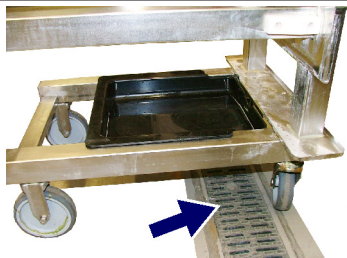
To empty the condensate collecting tray, follow the steps below:

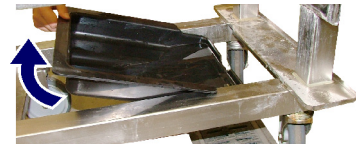
Step	Action	Illustration
1	Wheel the loading trolley over a drain gully.	
2	Pull the condensate collecting tray back slightly.	
3	Tip the condensate out of the condensate collecting tray into the drain gully.	

Emptying the condensate collecting tray into a drain

To empty the condensate collecting tray, follow the steps below:

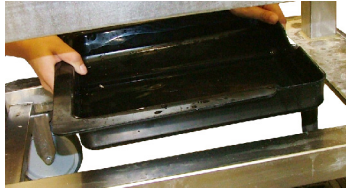
Step	Action	Illustration
1	Lift the condensate collecting tray out of the loading trolley.	
2	Empty the condensate out of the condensate collecting tray into a drain.	

More on this ...

How to do it correctly

<input type="checkbox"/> Loading table-top appliances using the transport trolley.....	172
<input type="checkbox"/> Opening the appliance door safely	165
<input type="checkbox"/> Loading table-top appliances / removing food from table-top appliances.....	170
<input type="checkbox"/> Loading floor-standing appliances	176

▶ Cleaning the armature

Hot surfaces

▲WARNING

Risk of burns from high temperatures inside the oven and on the inside of the appliance door

You may get burnt if you touch any of the interior parts of the oven, the inside of the appliance door or any parts that were inside the oven during cooking.

- ▶ Wear personal protection equipment as specified in safety regulations.

Materials required

You need the following materials:

- None

Cleaning the armature

To clean the armature, follow the steps below:

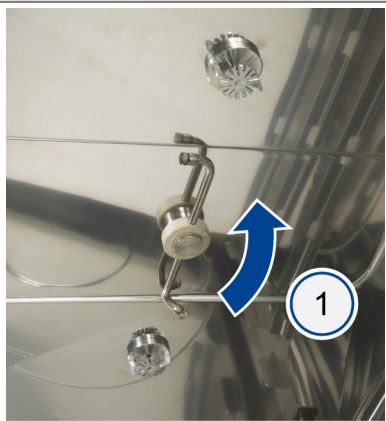
Step	Action	Illustration
1	Unscrew the armature (1).	
2	Wash the armature in the dishwasher.	
3	Screw the armature back on.	
4	Check that it can move freely.	

More on this ...

Related topics

□ Cleaning agents	160
□ Cleaning the double glass door.....	186
□ Cleaning the removable hygienic plug-in gasket	188
□ Cleaning the bypass measuring hole	189
□ Cleaning the demoinsturising tray.....	192

▶ Changing the cleaning canisters containing CONVOClean forte

Skin burns

▲WARNING

Risk of skin burns

The CONVOClean forte cleaning agent will cause skin burns if there is any direct contact, and care must be exercised when handling the cleaning canisters.

- ▶ Do not inhale the spray mist.
- ▶ Do not let CONVOClean forte come into contact with eyes or skin.
- ▶ Never open the appliance door during fully automatic cleaning.
- ▶ Wear protective clothing, protective gloves and safety goggles as specified in safety regulations.

Materials required

You need the following materials:

- Replacement canister of CONVOClean forte

Changing the cleaning canisters containing CONVOClean forte

To change the cleaning canisters containing CONVOClean forte, follow the steps below:

Step	Action
1	Remove the seal on the replacement canister of CONVOClean forte (1).
2	Unscrew the supply pipe plus suction nozzle from the empty canister.
3	Feed the supply tube plus suction nozzle into the replacement canister and screw it on.

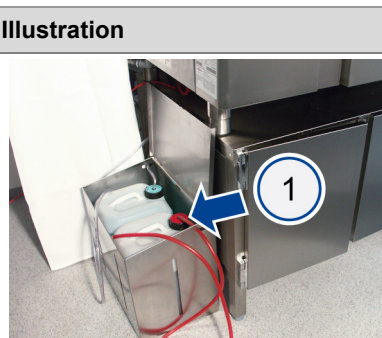

More on this ...

Related topics

- Fully automatic oven cleaning (CONVOClean system option) 156

► Changing the cleaning canisters containing CONVOCare

Cleaning agents

▲WARNING

Risk of skin and eye irritation or chemical burns

Direct contact with the CONVOClean new and CONVOCare cleaning agents will irritate the skin and eyes. Direct contact with CONVOClean forte will result in chemical burns.

- ▶ Do not inhale the spray mist.
- ▶ Do not let the cleaning agent come into contact with eyes or skin.
- ▶ Never open the appliance door during fully automatic cleaning.
- ▶ Wear protective gloves and safety goggles as specified in safety data sheet.

Materials required

You need the following materials:

- an empty CONVOCare canister
- CONVOCare concentrate (0.5 l)
- a sufficient amount of soft water (9.5 l)

Mixing the CONVOCare solution

To avoid excessive foaming, follow the procedure below when mixing the CONVOCare concentrate with water:

Step	Action
1	Open the empty canister and first of all add 9.5l of soft water to the empty canister.
2	Add 0.5l of CONVOCare concentrate to the water.
3	Replace the cap on the canister and tip it up to mix the two liquids together thoroughly.

Changing the cleaning canisters containing CONVOCare

To change the cleaning canister containing CONVOCare, follow the steps below:

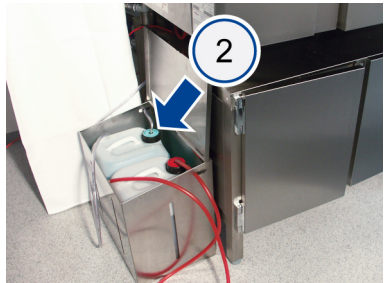
Step	Action	Illustration
1	Unscrew the supply pipe plus suction nozzle from the empty canister of CONVOCare (2).	
2	Feed the supply tube plus suction nozzle into the full canister and screw it on.	

More on this ...

Related topics

- Fully automatic oven cleaning (CONVOClean system option) 156



CONVOTHERM

OES OEB OGS OGB

6.10 / 6.20 / 10.10 / 10.20 / 12.20 / 20.10 / 20.20

Subject to technical changes.

CONVOTHERM Elektrogeräte GmbH
Talstraße 35
D-82436 Eglfing

Tel, +49 (0) 8847/67-0
Fax +49 (0) 8847/414
info@convotherm.de

www.convotherm.de



7017131_00 /02/10