

# ELECTRIC STEAM/CONVECTION OVENS

## INSTALLATION AND OPERATING INSTRUCTIONS

<b>Summary</b>	<b>Page</b>
- Installation diagrams.....	4
<b>APPLIANCE IDENTIFICATION.....</b>	<b>31</b>
<b>I. GENERAL CHARACTERISTICS.....</b>	<b>32</b>
1. <b>APPLIANCE DESCRIPTION .....</b>	<b>32</b>
2. <b>TABLE 1: TECHNICAL DATA.....</b>	<b>32</b>
3. <b>GENERAL INSTRUCTIONS .....</b>	<b>33</b>
3.1 PERSONAL PROTECTION EQUIPMENT .....	33
3.2 RESIDUAL RISKS.....	33
<b>II. INSTALLATION INSTRUCTIONS.....</b>	<b>34</b>
1. <b>PLACE OF INSTALLATION.....</b>	<b>34</b>
1.1 REFERENCE STANDARDS .....	34
2. <b>POSITIONING .....</b>	<b>34</b>
3.3 TECHNICAL DATA PLATE .....	34
4. <b>THE ENVIRONMENT.....</b>	<b>34</b>
4.1 PACKING.....	34
4.2 USE .....	34
4.3 CLEANING .....	34
4.4 DISPOSAL.....	34
3. <b>Electrical connection .....</b>	<b>35</b>
3.1 POWER CABLE INSTALLATION .....	35
4. <b>WATER CONNECTION.....</b>	<b>35</b>
4.1 SUPPLY WATER CHARACTERISTICS .....	35
4.2 WATER DRAINING SYSTEM.....	36
5. <b>SAFETY DEVICE .....</b>	<b>36</b>
6. <b>OPERATION CHECK.....</b>	<b>36</b>
17. <b>MAINTENANCE .....</b>	<b>36</b>
18. <b>BRIEF TROUBLESHOOTING GUIDE.....</b>	<b>36</b>
9. <b>POSITIONING OF MAIN COMPONENTS .....</b>	<b>36</b>

<b>III. OPERATING INSTRUCTIONS .....</b>	<b>37</b>
1. <b>OVEN DOOR OPENING .....</b>	<b>37</b>
1.1 6 AND 10-RACK MODEL .....	37
1.2 20-RACK MODEL.....	37
2. <b>Oven door closing .....</b>	<b>37</b>
2.1 6 AND 10-RACK MODELS.....	37
2.2 20-RACK MODELS .....	37
3. <b>DESCRIPTION OF CONTROL PANEL .....</b>	<b>38</b>
3.2 MAIN FUNCTIONS AND SYMBOLS.....	38
<b>OVEN USE.....</b>	<b>41</b>
4. <b>CONTROL PANEL USE.....</b>	<b>41</b>
4.1 SWITCHING THE OVEN ON .....	41
4.2 SWITCHING THE OVEN OFF .....	41
4.3 SELECTING CONTROLS (AREAS).....	41
4.4 MANUAL.....	42
4.5 AUTOMATIC.....	47
4.6 PROGRAMS.....	49
4.7 CLEANING .....	49
4.8 SETTINGS.....	50
5. <b>SWITCHING OFF IN CASE OF A FAULT.....</b>	<b>52</b>
6. <b>CLEANING AND MAINTENANCE.....</b>	<b>52</b>
6.1 STEAM GENERATOR PERIODICAL MAINTENANCE .....	53
6.2 REPLACING CONSUMABLE COMPONENTS.....	54
6.3 PARTICULAR CLEANING.....	54

## APPLIANCE IDENTIFICATION

"Technical Data" plate

PNC 9PDX **260462 05**

CE

**2. TABLE 1: TECHNICAL DATA**

6 GN 1/1	260462	260456	260457
260451-2000	260463	260457	260457
o	o	o	o
**	**	**	**
	230		

# I. GENERAL CHARACTERISTICS

## 1. APPLIANCE DESCRIPTION

This handbook concerns various appliance models. For further information regarding your model, refer to Table 1 "Technical Data".

The appliance has the following features:

- Digital indication of temperature.
- Thermostatic probe for measuring the product's "core" temperature (core probe).
- Constant monitoring of cooking parameters during the entire cycle.
- Periodical emptying and subsequent automatic cleaning of the steam generator to prevent excess scaling (depending on the model).
- Signalling the need for periodical boiler maintenance; see relevant section (depending on the model).

- Compartment rapid fume extraction device for gratinating, with automatic activation.
- AIR-BREAK anti-backflow device for preventing backflow from the drainage system entering the oven (depending on the model).
- Compartment lamps.
- Door opening double-action **safety** mechanism to prevent burns (depending on the model).
- Door with double glass: better comfort in the kitchen and low surface temperatures.
- Cycle for daily cleaning of oven compartment (CLEANING SYSTEM) (depending on the model).
- Self-diagnosis for possible malfunctions by means of signalling with identification codes.

## 2. TABLE 1: TECHNICAL DATA

GRIDS Oven weight (kg)	6GN1/1 132				10GN1/1 156				10 GN 2/1 202			20GN1/1 253,3			20 GN 2/1 344,25	
PNC *	267200 267210 237200 237210 267300	267220 237220	267230	267202 267212 237202 237212 267302	267222 237222	267232	267203 237203 267303	267033 237033	267204 267214 237204 237214 267304	267224 237224	267234	267205 237205 267305				
CONVECTOR ° BOILER **	° **	° **	° **	° **	° **	° **	° **	° **	° **	° **	° **	° **	° **	° **	° **	° **
POWER SUPPLY VOLTAGE (VOLT)	400 3 N~	230 3 ~	200 3 ~	400 3 N~	230 3 ~	200 3 ~	400 3 N~	200 3 ~	400 3 N~	200 3 ~	400 3 N~	230 3 ~	400 3 N~	400 3 N~	400 3 N~	400 3 N~
FREQUENCY (Hz)	50/60	50/60	50/60	50/60	50/60	50/60	50/60	50/60	50/60	50/60	50/60	50/60	50/60	50/60	50/60	50/60
Max. electrical power input (Kw)	10,1	10,1	10,1	17,5	17,5	17,5	25	25	34,5	34,5	34,5	34,5	50	50	50	50
Mains fuses (3 x 500V)	25	32	40	32	50	63	63	100	63	125	100	100	100	100	100	100
Power supply cable cross section (mm <sup>2</sup> )	5x2,5	4x4	4x4	5x4	4x10	4x10	5x10	5x16	5x10	4x25	5x16	5x16	5x16	5x16	5x16	5x16
Fan motor power rating (Kw)	0,19	0,19	0,19	0,19	0,19	0,19	0,75	0,75	0,38	0,38	0,38	0,38	1,5	1,5	1,5	1,5
Steam unit power rating (Kw)	9	9	9	17	17	17	24	24	24	24	24	24	48	48	48	48
Convection unit power rating (Kw)	9,6	9,6	9,6	17	17	17	24	24	34	34	34	34	48	48	48	48
Max. food load (kg)	30	30	30	50	50	50	100	100	100	100	100	100	200	200	200	200
Pan / tray max. load (kg)	15	15	15	15	15	15	30	30	15	15	15	15	30	30	30	30

**Information on sound emissions:** The functional components of the appliances in question have a noise level not exceeding 70 dB (A).

\* The oven model is specified at the **PNC** field on the "Technical Data" plate located at the bottom on the left side.

### 3. GENERAL INSTRUCTIONS

The following symbols are used in the manual to mark and identify the various types of hazards:



**ATTENTION!**  
DANGER FOR THE HEALTH AND SAFETY OF OPERATORS.



**ATTENTION!**  
DANGER OF ELECTRIC DISCHARGE (Electrocution) - DANGEROUS VOLTAGE.



**ATTENTION!**  
RISK OF DAMAGE TO THE MACHINE.



- Before installing and using the appliance, carefully read this handbook as it provides important information and instructions on safe installation, use and maintenance.



- Keep this handbook for further consultation by the various operators, or in case the appliance is resold.



**Attention:** Appliance installation, any maintenance work and conversion to another type of gas must only be carried out by professionally qualified personnel authorised by the Manufacturer.

- This appliance is intended for collective use and is expressly designed for cooking food. Any other use is deemed improper. **The appliance must only be used by trained staff.**
  - This appliance is not intended for use by people (including children) with limited physical, sensory or mental abilities or without experience and knowledge of it, unless they are supervised or instructed in its use by a person responsible for their safety.
  - Switch the appliance off in case of fault or poor operation.
  - **For any repairs, only consult an After-Sales Centre authorised by the manufacturer and demand original replacement parts.**
- Failure to observe the above can compromise appliance safety and invalidates any form of warranty.**



- Do not clean the appliance with direct jets of water.

- Do not use products containing chlorine (chlorine bleach, hydrochloric acid, etc.), even if diluted, to clean the steel parts.
- Do not use corrosive substances (e.g. muriatic acid) to clean the floor under the appliance.
- For further details see the section "**Cleaning and maintenance**".

### 3.1 PERSONAL PROTECTION EQUIPMENT

Give below is a summary table of the Personal Protection Equipment (PPE) to be used during the various stages of the machine's service life.

Stage	Protective garments	Safety footwear	Gloves	Glasses	Ear protectors	Mask	Safety helmet
Transport		X					
Handling		X					
Unpacking		X					
Assembly		X					
Normal use	X	X	X (*)				
Adjustments		X					
Routine cleaning		X	X				
Extraordinary cleaning		X	X				
Maintenance		X					
Dismantling		X					
Scrapping		X					

Key:

X	PPE REQUIRED
	PPE AVAILABLE OR TO BE USED IF NECESSARY
	PPE NOT REQUIRED

(\*) During Normal use, gloves must be heatproof to protect hands when removing the hot pan from the appliance. Failure to use the personal protection equipment by operators, specialised technicians or users can involve exposure to chemical risk and possible damage to health.

### 3.2 RESIDUAL RISKS

The machine has several risks that were not completely eliminated from a design standpoint or with the installation of adequate protection devices. For the Customer's complete information, the residual risks remaining on the machine are indicated below: such actions are to be considered incorrect and therefore strictly forbidden.

RESIDUAL RISK	DESCRIPTION OF HAZARDOUS SITUATION
Slipping or falling	The operator can slip due to water or dirt on the floor.
Burns	The operator deliberately or unintentionally touches some components inside the machine or dishes at the out-feed without using gloves or without allowing them to cool.
Danger of electric discharge (Electrocution)	Contact with live parts during maintenance operations carried out with the electrical panel powered. The operator intervenes (with a power tool or without disconnecting the power to the machine) lying down on the wet floor.
Falling from above	The operator intervenes on the machine using unsuitable systems to access the upper part (e.g. rung ladders, or climbs on it).
Tipping of loads	During maintenance on the machine or the packing containing the machine with the use of unsuitable accessories or lifting systems or with load unbalanced. When handling pans containing food.

Chemical	Contact with chemical substances (e.g. detergent, rinse aid, scale remover, etc.) without taking adequate safety precautions. Therefore always refer to the safety cards and labels on the products used.
----------	---

### 3.3 TECNICAL DATA PLATE

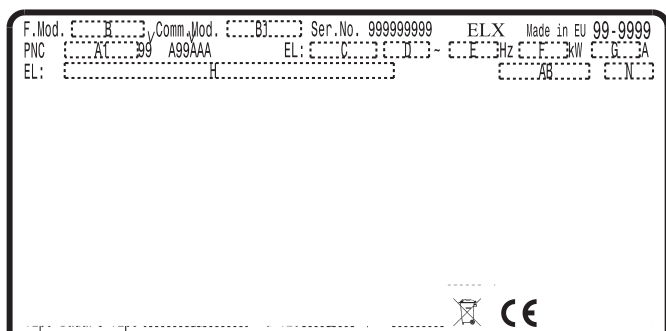

Meaning of fields given on the plate:

F. Mod. .... factory description of product  
 Comm. Model ..... commercial description  
 Ser. Nr. .... serial number  
 ELX ..... manufacturer: Electrolux Professional spa  
 Viale Treviso, 15  
 33170 Pordenone (Italy)

Made in EU ..... place of manufacture  
 99-9999 ..... month/year of manufacture  
 PNC: ..... production number code  
 EL: ..... [C] power supply voltage, [D] phase  
 Hz ..... power supply frequency  
 kW ..... max. power input  
 A ..... current absorption  
 EL: ..... [H] electrical prearrangement  
 CE ..... CE marking

## 4. THE ENVIRONMENT

### 4.1 PACKING

• All the packing materials are environmentally friendly. They can be stored without risk or burned in a special waste incineration plant. Recyclable plastic components are marked as follows:



**polyethylene:** outer wrapping, instructions bag, gas nozzle bag.



**polypropylene:** roof packing panels, straps



**polystyrene foam:** corner protectors

### 4.2 USE

• Our appliances are designed and optimised with laboratory testing in order to offer high performance and efficiency. In any case, to reduce energy consumption (electricity, gas and water), avoid using the appliance empty for long periods or in conditions that compromise optimum efficiency (e.g. door open). Also, if possible, preheat the appliance immediately before use.

### 4.3 CLEANING

• In order to reduce the emission of pollutants into the environment, clean the appliance (externally and when necessary internally) with products that are over 90% biodegradable.

### 4.4 DISPOSAL

• At the end of the product's working life, make sure it is not dispersed in the environment.  
 • Our appliances are manufactured using more than 90% metals (stainless steel, iron, aluminium, galvanised sheet, copper, etc.) which can be recycled by means of the conventional recovery structures, in compliance with the current regulations in the country of use.  
 • Make the appliance unusable by removing the power cable and any compartment or cavity closing devices (when present) in order to avoid the risk of someone becoming trapped inside.

The symbol  on the product indicates that this product should not be treated as domestic waste, but must be correctly disposed of in order to prevent possible negative consequences for the environment and the human health.

Regarding the recycling of this product, please contact the sales agent or dealer of your product, your after-sales service or the appropriate waste disposal service.

## II. INSTALLATION INSTRUCTIONS



**Attention:** The external panels of the oven must be removed for the operations described in this section. As the unit must be operating in order to carry out some adjustments, pay maximum attention to the live parts.



**Attention:** Maintenance in the upper part of the appliance requires the use of ladders with protection (guard).

### 1. PLACE OF INSTALLATION

• Only install the appliance in a suitably ventilated place.

### 1.1 REFERENCE STANDARDS

• Install the appliance in compliance with the current local and national regulations.

### 2. POSITIONING

• Unpack the appliance, carefully remove the protective film from outside panels, making sure no traces of glue remain. If necessary, remove them using a suitable solvent. Remove the packing using protective gloves. Lift the appliance with a lift truck, remove the base, and position it the place of use.

Remove the protective film and make sure the packing material is not dispersed in the environment but disposed of according to the current regulations in the country where the product is used.

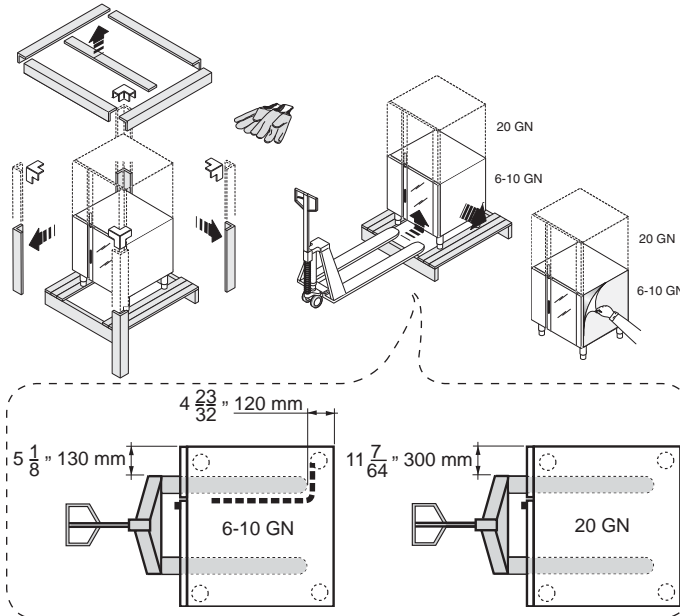

- For disposal of the packing, see the section "The Environment"
- For the overall space required and connection dimensions, refer to the installation diagrams given on the first pages of this instruction handbook.
- The left side of the appliance must remain at least **50 cm** from other surfaces to enable maintenance operations, whereas the right side and back must remain **10 cm** from any surface.
- Position the appliance on a flat surface and, if necessary, adjust the height of the worktop by means of the adjustable feet.
- The appliance is not suitable for built-in installation.

**Attention:** Make sure the steam coming from the oven discharge or adjacent appliances does not reach the aeration vents (for cooling internal components), located at the bottom of the appliance.

### 3. ELECTRICAL CONNECTION

- **Connection to the electrical power supply must be done in compliance with the current national and local regulations.**
- Before connecting, make sure the voltage and frequency match that given on the dataplate.
- The appliance must be connected to the power supply in a permanent way. Connection must be made with an H05 RN-F type cable. The power cable must be installed in a metal or rigid plastic pipe without any sharp parts.
- An omnipolar switch of suitable capacity with contact opening distance of at least 3 mm must be installed ahead of the appliance. This switch must be installed in the building's permanent electrical system, in the immediate vicinity of the appliance.
- A device (interlocked plug, lockable switch or similar devices) lockable in the open position during maintenance must be installed ahead of the appliance.
- Appliance max. leakage current is 5 mA.
- The appliance must be connected to an efficient earthing system. For that purpose, the connection terminal block has a terminal with the symbol  $\oplus$  for connecting the earth wire. The appliance must also be included in an equipotential system. This connection is made with the setscrew marked  $\nabla$ , located externally near the power cable entry. The equipotential wire must have a section of at least 10 mm<sup>2</sup>.

#### 3.1 POWER CABLE INSTALLATION

To connect the power cable to the appliance, proceed as follows:

- Model 6 - 10 - 20 GN**
- Remove the left side panel.
  - Connect the cable to the terminal block as shown in the wiring diagram attached to the appliance, and secure it with the special cable gland.

**The manufacturer declines any liability if the current national and local regulations and possible safety regulations are not respected.**

### 4. WATER CONNECTION

(See the installation diagrams at the beginning of this handbook)

**When connecting the appliance to the water system with flexible tubes they must be new and not used.**

The oven has two separate inlets ("B" and "N") for the supply water. The supply pipes of both inlets must be equipped with a mechanical filter and shutoff cock. Before installing the filters, it is advisable to let a certain amount of water flow in order to clean the pipe of any solid particles.

**Pressure between 150 and 450 kPa (1.5-4.5 bar).**

#### WATER INLET "N"

**Attention** (water inlet N)  
If the supply pipes provided with the appliance are not long enough for installation, use longer ones with **int. diameter at least  $\varnothing$  20 mm** and free of elbow unions.

**Note:**  
To check correct water installation, make sure the rotating wash arm (CLEANING SYSTEM) does not turn below 100 rpm (120 max.).

#### 4.1 SUPPLY WATER CHARACTERISTICS

The appliance must be supplied with **drinking water** having the specific characteristics given in this section.

#### HARDNESS FILTER

Water inlet	Appl.	Hardness		
		°f	ppm	°dH
B	Touch	0,5 - 5	5 - 50	0,28 - 2,8
N	Touch	max 5	max 50	max 2,8

The **hardness** values given in the table are for reducing scaling inside the steam generator and for the oven compartment cleaning system.

If the available water does not have these hardness characteristics a water softener must be installed. Therefore the Automatic Water Softener with automatic regeneration for installing on the inlet line can be requested as an accessory; it has a Resin Sterilizer kit (also by request).

#### HARDNESS AND CHLORIDE FILTERS

The **chlorine concentration (Cl-) (ppm - mg/l)** values with **pH (>7)** and **Conductivity ( $\mu$ S/cm)** (measured at 20°C) must be such as not to harm the steel structures inside the oven (water inlet B only).

For that purpose it is necessary to identify the characteristics of the available water on the graph given on the last pages of this handbook (page 299), and if necessary install at the inlet the type of filter indicated in the relevant area of values.

- The filters indicated are:
- No filter for chloride (Cl-) in the conforming area (Normal)
  - Nanofilter as an accessory on request, called Water Filter.
  - Osmotizer.

Check that the water coming out the filter is inside the optimum area (Normal). These filters also reduce the water hardness to optimum values (below 5°f), and therefore also act as a softener.

**ATTENTION:** The periodical check of filter efficiency, according to that indicated by the manufacturer, is important to avoid compromising appliance operation and the risk of corrosion. Level C ovens are convection ovens. The use of water with non-conforming characteristics inside the oven compartment for generating humidity creates the risk of corrosion of the compartment and its contents.

Regular maintenance of water softeners and filters is necessary to ensure their efficiency.

To avoid damaging the appliance, with every periodical regeneration do a filter cleaning cycle without introducing water in the oven. The manufacture declines any liability in case of incorrect maintenance.



**Attention:**  
Dispensers of substances for preventing scale in the pipes (e.g. polyphosphate dispensers) must not be used because they can compromise correct appliance operation.

## 4.2 WATER DRAINING SYSTEM

The oven has an AIR-BREAK anti-backflow device inside to prevent any backflow from the drainage system entering the internal pipes and the oven compartment. This allows the drain pipe to be connected directly to the mains system or discharging into a floor grate.

The drain pipe (rigid or flexible type) can be run to the side or back if the oven is not placed against a wall, excluding the front part with rack support structure. It must **not be more than 1 metre** long, with inside diameter not less than that of the oven discharge pipe (1" 1/4), and must withstand temperatures of at least 100°C. Make sure there are no constrictions in hoses or elbows in metal pipes, along the entire drain path. Avoid horizontal sections where water can collect and stagnate (min. slope 5%).

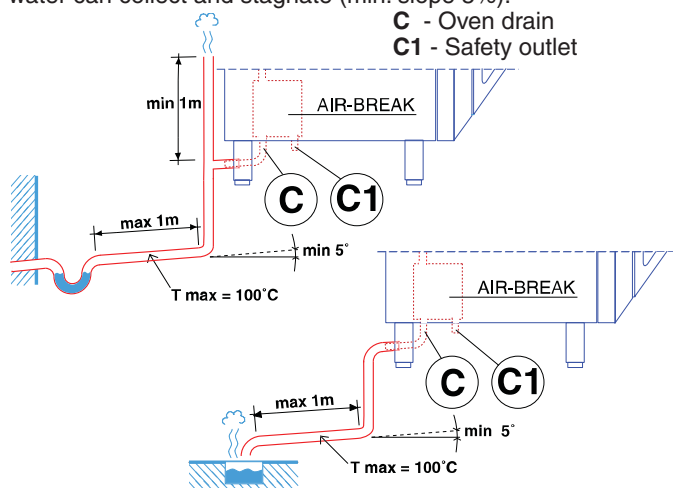

### Attention:

- Do not obstruct the safety outlet C1.
- Do not connect the safety outlet C1 to the drainage system.

### Note:

If water comes out of the AIR-BREAK (safety outlet C1) it means the drain C is blocked. Elimination of the obstruction **must be carried out by specialised technical personnel**.

## 5. SAFETY DEVICE

The appliance is equipped with the following safety devices:

- **Fuses**, see the wiring diagram, located behind the control panel. For replacement, unscrew the cap and replace the damaged component with another one having the same rating; this value is given on the label located in the same place.

- **Compartment manual-reset safety thermostat** located behind the control panel; it shuts off the gas supply to the convector burner.

- **Steam generator manual-reset safety thermostat** located behind the control panel; it shuts off the gas supply to the generator burner.

Resetting operations must be carried out by specialised technical personnel after eliminating the causes of interruption.

- **Automatic-reset thermal device** inside the fan, which is activated if the fan overheats, protecting unit operation; it cuts off the electrical power to the appliance.

## 6. OPERATION CHECK

- Switch the appliance on, as described in the section "Operating instructions";

- Explain appliance operation, routine maintenance and cleaning operations to the user, with the help of the instruction handbook.



### Attention:

- During operation, pay attention to the hot areas of the exterior surface.
- Do not place objects on the outlets located at the top of the appliance.

- With oven hot, check the correct working of the door closing mechanism. If necessary, adjust closing by adjusting the position of the catch.

## 17. MAINTENANCE

The components requiring routine maintenance are accessible by opening the control panel, and left and rear panels.

## 18. BRIEF TROUBLESHOOTING GUIDE

Even with correct use of the appliance, malfunctions can occur.

**Oven chamber heating not started or inefficient.** Possible causes:

- Oven chamber temperature limit switch tripped
- Damaged heating elements
- Damaged heating element contactor coil
- Damaged thermostat probe showing error "EPt1".
- Damaged controller
- Fuse "F2" blown, see circuit diagram.

**Steam production not started or inefficient.**

Possible causes:

- Damaged heating elements
- Damaged heating element contactor coil
- Damaged controller
- Fuse "F2" blown
- No mains water supply
- Faulty boiler drainage outlet closing device
- Damaged water inlet solenoid valves (do not open)

**Oven chamber temperature reading incorrect**

Possible causes:

- Damaged electronic controller
- Thermostat probe damaged, dirty or interrupted, see error "EPt1".

**Oven switches off**

Possible cause:

- Fuse "F2" has blown due to damage of control circuit components.

**Oven chamber lamp fault**

**WARNING:** Switch off the appliance before changing oven chamber lamps.

## 9. POSITIONING OF MAIN COMPONENTS

**(Any operation inside the appliance must only be carried out by an installer authorised by the Manufacturer).**

Removing the control panel provides access to the following components:

- Electronic circuit boards
- Oven chamber temperature limit thermostat
- Fuses
- Door microswitch
- Oven chamber lamp transformer
- Geared motor for the oven chamber pressure relief butterfly valve.

To gain access to all other components remove the appliance's left and rear side panels.

## III. OPERATING INSTRUCTIONS

Before starting the appliance, carefully read this handbook. The instructions and information given in it are important for correct and optimum oven use. If required, further details regarding its characteristics and cooking performance can be obtained from the dealer.

- To avoid obstructing the fume and steam discharge pipes, do not place pans or utensils of any kind on the oven.
- Do not place objects (e.g. pans) under the bottom of the oven, so as not to obstruct any cooling air inlet or outlet holes.
- Have the appliance fully checked periodically (at least once a year). For that purpose, it is advisable to stipulate a maintenance contract.
- The core probe is a precision component. Absolutely avoid impacts, forcing when inserting, and pulling of the flexible cable (in particular when using the trolley-mounted structures). **The warranty does not cover the replacement of core probes damaged by improper use.**
- In the **combi** cooking cycle it is advisable not to exceed temperatures of 200-210°C. Higher values can reduce the efficiency of the compartment seals.
- When arranging food inside the oven compartment, keep a space of at least 40mm between trays, to ensure better circulation of hot air.
- If the oven is installed near appliances that produce greasy fumes (e.g. fryer), make sure to use the **air filter** (not supplied), to be placed under the **control panel**, to protect the internal electronic components.
- During **preheating** of oven 20 GN 1/1 or 2/1, insert the trolley (without food) or the special accessory (not supplied) to close the bottom opening between the compartment and door. This prevents steam from coming out and into the control panel with consequent damage to the electronic board.

- **Do not salt food inside the oven, in particular with humid cycles.**
- **Do not place flammable liquids (e.g. spirits) inside the oven during operation.**



### Attention!

The maximum height at which the **trays** are placed in the oven does not exceed **1.6 m**. This applies if it is installed according to the instructions and with the use of original accessories.

Whenever using supports different from ours, **do not exceed** the above-mentioned height when installing the oven. Otherwise there could be the **risk** of spilling hot cooking liquids (sauces, oil, melted fat, etc.) contained in the high trays and not visible during handling.

## 1. OVEN DOOR OPENING

### 1.1 6 AND 10-RACK MODEL



### Attention! Risk of burns.

**Always** open the door with caution when the oven is hot.

- a) Turn the door handle all the way in either direction (indifferently) to fully open the oven door.  
The cooking cycle is stopped, if in progress.

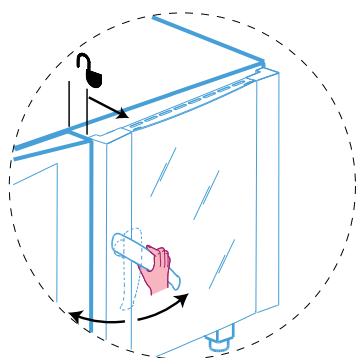

### MODELS WITH DOUBLE OPENING SYSTEM (on request)

The oven has a **double opening system** to prevent being exposed to steam when opening the door completely; therefore carry out the following operations:

- a) Turn the door handle all the way clockwise. The door opens a little, hooking on the **stop**. The cooking cycle is stopped, if in progress.

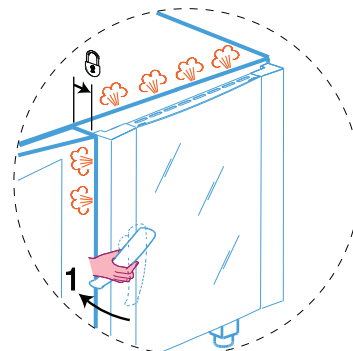

- b) Turn the handle all the way anticlockwise to open the oven door completely.

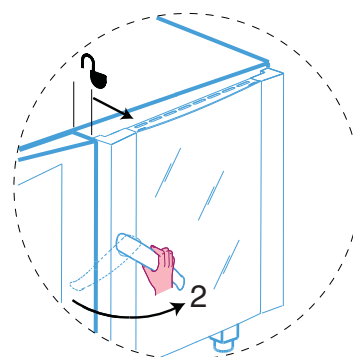

### 1.2 20-RACK MODEL



### Attention! Risk of burns.

**Always** open the door with caution when the oven is hot.

- a) Turn the handle anticlockwise 90° to open the door completely. The cooking program is stopped, if in progress.

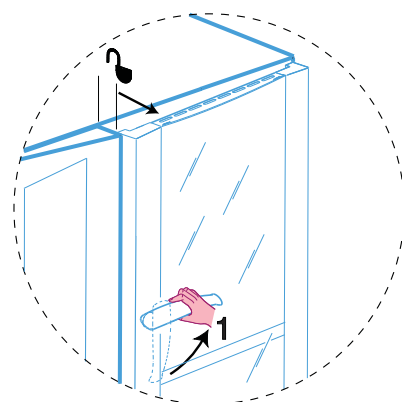

## 2. OVEN DOOR CLOSING

### 2.1 6 AND 10-RACK MODELS

Closing is obtained by pressing the door against the oven enough to lock it.

### 2.2 20-RACK MODELS

- a) Turn the door handle all the way anticlockwise and bring the door against the oven.  
b) Keeping the door pressed against the oven, bring the handle to the upright position and lock it.

### 3. DESCRIPTION OF CONTROL PANEL

The control panel has the following controls:

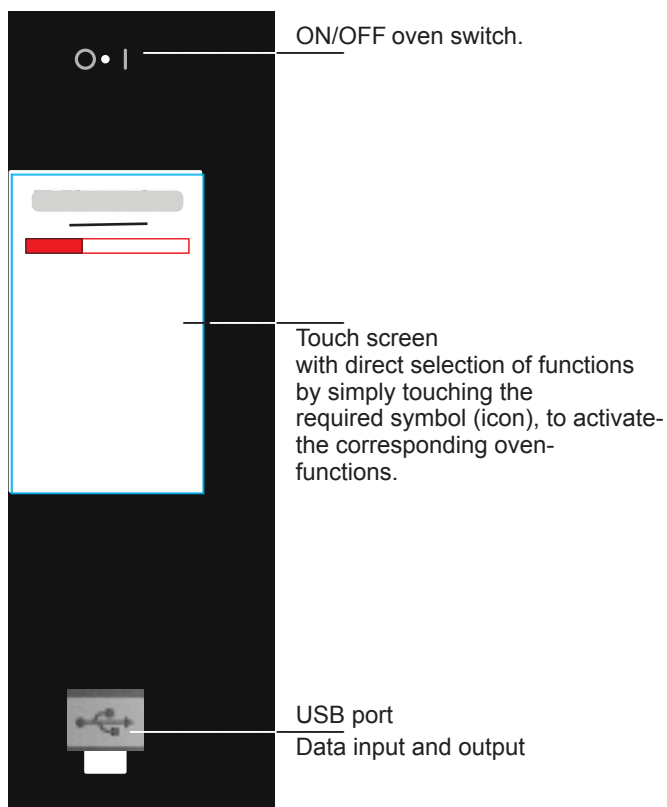

#### 3.2 MAIN FUNCTIONS AND SYMBOLS

##### MANUAL

**Hot air cycle:** for roasting and gratinating with max. temperature 300°C.

**Combi cycle:** superheated steam. The steam generator and compartment heaters are used at the same time to keep foods tender (max. temperature 250°C).

**Steam cycle:** ideal for boiling (operating temperature automatically fixed at 100°C).

**Low temperature steam** can be set for gentle cooking, vacuum packed foods and for defrosting (temperature from 25°C to 99°); **superheated steam** (temperature from 101° to 130°C).

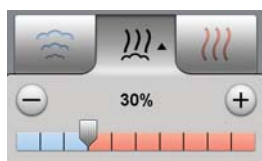

**Electronic humidity adjustment:** for adjusting the required humidity level in the **Combi Cycle**.

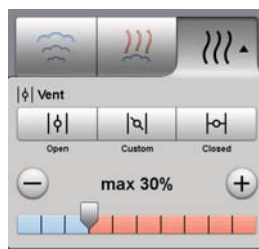

**Humidity setting and adjustment:** for activating or excluding the humidity or adjusting the required level in the **Hot Air Cycle**.

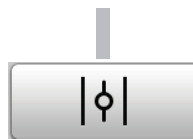

**Hot air cycle with compartment vent open:** for very dry cooking, allowing the removal of humidity when necessary (max. temperature 300°C).



**Hot air cycle with adjustable compartment vent:** for cooking with humidity adjustable from 1 to 99 %, allowing the removal of humidity when the set value is exceeded.

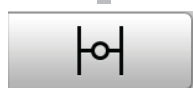

**Hot air cycle with compartment vent closed:** for cooking with high humidity. (Default setting)



**Digital thermostat** for control of compartment temperature.



**Timer** for control of cooking time. The letter S next to the number means short cooking cycle; see symbol MM:SS.

or



**Digital thermometer/thermostat** for control of product core temperature.

**Cooking with ECO-DELTA:** for cooking large pieces of food (at least 5kg, e.g. whole turkey, leg of pork, etc.). In this cooking mode a temperature setting of between 1°C and 120°C is selected.

In this case, cooking is moderate and long, since the COMPARTMENT temperature is automatically adjusted according to the temperature inside the food (CORE PROBE), maintaining a constant difference (ECO-DELTA) between them, from start to end of cooking.

The **ECO-DELTA** function is only possible with the core probe inserted.

Example:

COOKING:	START	.....	END
ECO-DELTA	= 80°... 80...80... 80...		80°C (set)
CORE PROBE	= 10°... 11...12... 40...		60°C (set)
COMPARTMENT	= 90°... 91...92... 120...		140°C (result)





**Fast compartment cooling:** useful for going from one type of cooking to another at lower temperature; it enables fan rotation and automatic injection of water (TS < 180°C) even with the door open.

**Attention!** Risk of burns. Always open the door with caution when the oven is hot.



**Continuous cooking:** the cooking time is endless, therefore it is necessary to press STOP when the food is cooked.



**MM:MINUTES** and **SS:SECONDS** for short cooking cycles. Converts minutes into seconds and the letter S appears next to the number in the bar as an indicator

**INFORMATION - NOTES - WARNINGS**



**Information area**  
Area displaying current Status, Error, Warning and Utility information.



**Warning light signalling oven door open.**



**Scale indicator:** when this light comes on, the steam generator must be descaled. Follow the instructions given in par. 6.1.

**Steam generator status light:**



- generator in **filling** phase or no water. **Make sure water reaches the oven!**



- generator in **preheating** phase.



- generator **ready** (indicator light off).



**Error**



**Attention**



**Information**



**Queries**

**UTILITIES**



**Low speed cycle (fan):** for gentle baking, such as light patisserie. Combinable with all cycles.



**Pulsed speed cycle (fan):** for low temperature cooking, ideal for maintaining cooked products, dehydrating or drying for vegetables or finishing food. Combinable with all cycles.



**Normal speed cycle (fan):** for normal cooking. Ideal for roasting, gratinating and classic cooking. Combinable with all cycles. (Default setting)



**Manual injection of water in compartment:** for instantly increasing the humidity level during a cooking cycle. Use the + and - buttons to adjust the injection duration in seconds (10 s intervals).



**Low power cycle (heating):** for gentle baking, such as light patisserie. Combinable with all cycles.



**FSC-STANDARD risk cooking:** for foods having a low contamination level.



**FSC-HIGH risk cooking:** for foods having a high contamination level.



**FSC-The FOODSAFE CONTROL** had positive results, cooking occurred in safe conditions



**Save Program**



**Multitimer:** for setting cooking of foods at the same temperature but at different times (max. 14).

**MULTIPHASE**



**Cooking with phases in sequence:** for setting cooking programs with several phases in automatic sequence (max. 15 phases).



**Active pause phase**



**Add pause phase:** by entering a time value in this mode it is possible to delay the start of cooking programs or include a pause between two cycles (e.g. proving).



**Active Maintaining Cycle phase.**



**Add Maintaining Cycle (70°C):** for slow and prolonged cooking, typically for meat (large cuts). Activated at the end of cooking.  
Combinable with all cycles.

### SPECIAL CYCLES



**Regeneration cycle:** produces the optimum humidity for fast heating of products to be regenerated. Ideal cycle for heating and regenerating complete menus, single or multiple portions (e.g. banqueting) in pans or single dishes. Also ideal for regenerating stale bread.



**Low Temperature:** low temperature cooking cycle to obtain tender and evenly cooked food.



**Proving:** Ideal cycle for raising baking products, buns, pizzas and various doughs.

### VARIOUS AND COMMON FUNCTIONS



**Manual draining of steam generator water:** press the button to drain water from the steam generator. (See 6.1 STEAM GENERATOR PERIODICAL MAINTENANCE)



**Attention! In order to prevent excessive scaling in the steam generator, make sure to:**

- respect the parameters regarding the water supply – see installation;
- always drain the generator at the end of each day.



**Compartment preheating:** indicates that the oven is preheating the compartment (please wait). This phase can be skipped in MANUAL mode but not in AUTOMATIC mode.



**SKIP PHASE:** the next foreseen phase can be skipped for particular types of cooking.

- Compartment preheating (excluding AUTOMATIC)
- Low temperature phases (PREHEAT, SEARING)



**Skip PHASES in Multiphase:** one or more phases can be skipped during cooking with Multiphase.



**Confirm**



**Go back to previous page**



**Cancel space (Backspace)**



**Find Program**



**Custom**



**Upload data in oven from USB port**



**Download data from oven on USB port**



**Restore oven configuration to default values (Reset)**



**Drawer**

The drawer is an expansion located inside several environments of the menu and contains options that are useful in some functions.

# OVEN USE

## 4. CONTROL PANEL USE

### Foreword:

When selecting certain functions, the initial status is restored if no button is pressed within 15 seconds (approx.).

### 4.1 SWITCHING THE OVEN ON

Before using the oven, make sure:

- the external electric safety switch is on;
- the water shutoff cocks are open;
- the oven outlets are not blocked.

Switch the oven on by pressing the button I (O - I) of the following switch:



the start screen will appear, during which the electronic board performs several checks.

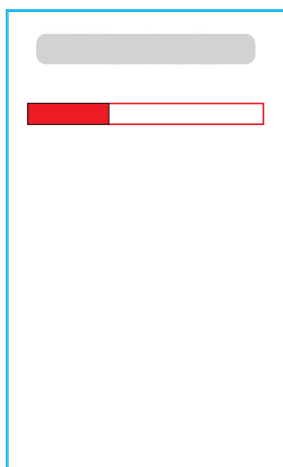

**Touch screen**

Touch the symbols on the "touch screen" to select the oven functions, setting and modifying the relevant values. It is also arranged with a basic functions menu to simplify use, and can be customised as required by adding or removing some functions. The "touch screen" has a similar use to that of a cell phone and computer, with drop-down menu and keypad for entering values. In some cases, by touching the required symbol a screen relevant to the symbol appears, and in others only the function is selected.

**TOUCH** the required part of the Display to perform any operation, such as:

- select
- confirm
- change screen (or Display page)

### 4.2 SWITCHING THE OVEN OFF

To switch the oven off, press the button O (O - I) of the following switch:

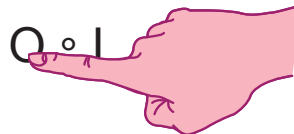

### 4.3 SELECTING CONTROLS (AREAS)

The controls are mainly divided into 5 different management areas for the various functions. These are selected from the CONTROLS MENU in the drop-down menu of the first line of MANUAL mode.

Manual	= manual cooking mode (conventional).
Programs	= use of existing programs (or recipes) and storing of new ones.
Automatic	= automatic cooking system.
Cleaning	= cleaning programs for oven compartment.
Settings	= variation and configuration of functions.

## 4.4 MANUAL



After SWITCHING THE OVEN ON the following MANUAL cooking mode screen appears:

Drop-down "CONTROLS MENU":

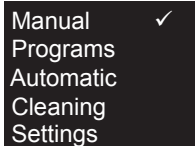

<input checked="" type="checkbox"/> Manual		
<input checked="" type="checkbox"/> Phase	1 of 1	Cooking PHASES (1 of 1)
50%		Set COMBI cycle
		Cooking CYCLES
		Set HUMIDITY
48°		Set TEMPERATURE
0:30		Current TIME
		Set TIME
START		Start CYCLE
		INFORMATION AREA

"DRAWER" drop-down menu with Utilities in several items of the CONTROLS MENU

To set a cooking cycle, select the required CYCLE:

	HOT AIR	(touch)
	COMBI	(touch)
	STEAM	(touch)

and set:

- HUMIDITY (excluding STEAM cycle) (touch CYCLE button)
- TEMPERATURE (touch the bar )
- TIME (touch the bar )
- or CORE PROBE (touch the bar and then )

In this way a cooking Cycle is set, then just touch START to start the Cycle.

After about 10 seconds the PREHEATING screen appears and then the following Cooking in Progress screen:

Phase 2/3	Cooking PHASE (2 of 3)
Combi	COMBI cycle * in progress
	HUMIDITY in progress
160°	Set TEMPERATURE
2:17	TIME in progress
2:30	set TIME
	HALF SPEED in progress
	(example)

\* In PROGRAMMED mode, the word "Combi" will be replaced by the name of the Program or Recipe in progress (e.g. Chicken)

This figure (for information) shows nearly all the possible cases; but only those concerned are presented.

Touch this screen to return to the MANUAL control Settings. Any setting already made can be modified and the Cooking Cycle can be stopped by touching STOP for a few seconds.

The SKIP COMPARTMENT PREHEATING function also appears with the respective symbol next to the STOP button, to skip preheating for particular types of cooking.



The previous description regarded setting a cooking Cycle. Now, this will enable setting others in a more complex way, by adding the other functions made available.

The functions in MANUAL Cooking mode are as follows:

	cycle HOT AIR	HUMIDITY	TEMPERATURE	TIME	CORE PROBE
	adjustable	x (vent )	x	x (max. 8 hours)	x (from 10° to 99°)
	compartment vent open	x	-	-	-
	compartment vent closed	x	-	-	-
	Eco Delta *	-	x (from 20° to 120°)	-	-
	endless	-	-	x	-
	MM:SS (short cooking cycles)	-	-	-	max. 59 min. and 59 sec. -
	cycle COMBI	HUMIDITY	TEMPERATURE	TIME	CORE PROBE
	adjustable	x (%)	x	x (max. 8 hours)	x (from 10° to 99°)
	Eco Delta *	-	x (from 20° to 120°)	-	-
	endless	-	-	x	-
	MM:SS (short cooking cycles)	-	-	-	max. 59 min. and 59 sec. -
	cycle STEAM	HUMIDITY	TEMPERATURE	TIME	CORE PROBE
	adjustable	-	x	x (max. 8 hours)	x (from 10° to 99°)
	Eco Delta *	-	x (from 20° to 120°)	-	-
	endless	-	-	x	-
	MM:SS (short cooking cycles)	-	-	-	max. 59 min. and 59 sec. -

\* Eco Delta: on setting the temperature range, a small triangle will appear as a reference next to the value; also, the time bar goes to that of the core probe for the relevant setting.

E.g. In the HOT AIR cycle, as indicated in the previous table, it is possible to set the Humidity, Temperature, Time or Core Probe, and Temperature with Eco Delta, compartment Cooling, endless Time for continuous Cooking (conventional cooking) and Short Cooking Cycles (MM:SS).

To set the data of the various functions, a keypad like the following is used:



To zero-set the value just entered, touch the 0 on the keypad.

If a function (e.g. Eco Delta ) has been set on the keypad, to cancel it just touch the same button again.

To return to the initial setting, select another cycle and return to the same.

Cooling: it is possible to set an oven compartment cooling temperature to be reached, which will be indicated with the corresponding symbol on the cooking in progress screen. Compartment cooling therefore occurs manually and is done outside the cooking cycle.

To add more functions, there are the UTILITIES situated in the DRAWER and selected as cooking cycle variables.

Labels on the right side of the screenshot:

- DRAWER open
- UTILITIES
- INFORMATION
- real data

### UTILITIES (see page 39)

cycle	HOT AIR	COMBI	STEAM
Fan speed *	x	x	x
Injection of water in compartment x (from 10sec. to 120sec.) -			-
Reduced power	x	x	x
Programmed Start	x	x	x
FSC (Food Save Control)	x	x	x
Store programs	x	x	x

\* The default speed is the maximum and never appears in the information field, whereas the others will appear if selected (half or pulsed).

### INFORMATION (real data)

	23%	humidity
	175°	compartment temperature (C°)
	28°	core probe temperature (C°)
	01:58	clock (1 hour : 58 minutes)

#### 4.4.1 MULTIPHASE

Food can be cooked with different modes during its cycle and therefore in different phases.

The oven enables programs consisting of several sequential phases (up to a max. of 15 phases). During cooking, going from one phase to the next occurs automatically, until automatic stopping of the program with completion of the last set phase.

A cycle with several phases is set by carrying out the following operations:

- 1) switch the oven on;
  - 2) Set for PHASE 1:
    - cooking mode (humidity if necessary);
    - compartment temperature;
    - cooking time (or alternatively the core probe temperature).
  - 3) Press the "Phase" button and then the "Add new phase" button.
  - 4) For PHASE 2 and following, set as per PHASE 1.
- When there are several phases, these will be listed, giving the relevant settings (an arrow will scroll the next ones which are not displayed).

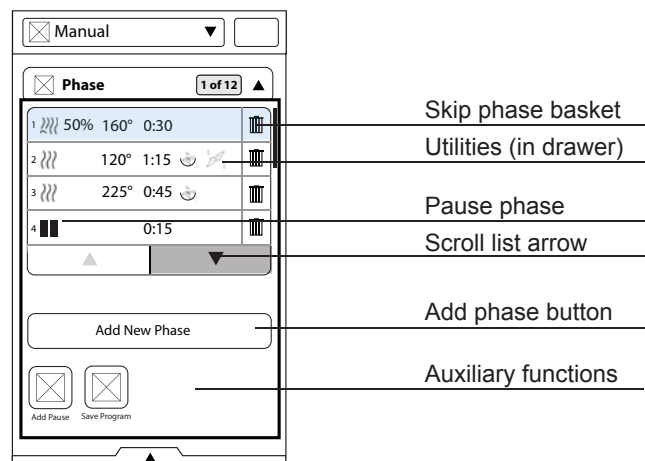

The figure shows phase 1 with the following settings:

- 1 phase number
- combi cycle
- 50% humidity
- 160° temperature (C°)
- 0:30 cooking phase time (0 hours : 30 minutes)

Also, one or more phases can be skipped during cooking; press the symbol next to phase 3 (ex. in figure) to go to this.

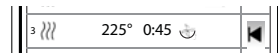

The Multiphase also has special phases, such as:

- Pause for setting a pause between cooking cycles.
- Maintaining cycle with the possibility of setting a food temperature that is kept constant for an infinite time 8 .

#### 4.4.2 MULTITIMER

With the MultiTimer system it is possible to set a different time for each recipe (chicken, potatoes, etc.) or for each pan placed on the various levels, e.g. starting from level 1 at the top and going down to 2, 3, etc.

This function also allows the oven to be used with an "à la carte" menu, where the food can be placed in the oven at the required time.

To set the MultiTimer, proceed as follows:

- 1) open the drawer in Manual mode and press the relevant button



Then press the following buttons:

- 2) START cycle start for setting the Multitimer



- 3) MultiTimer to access the setting of times.

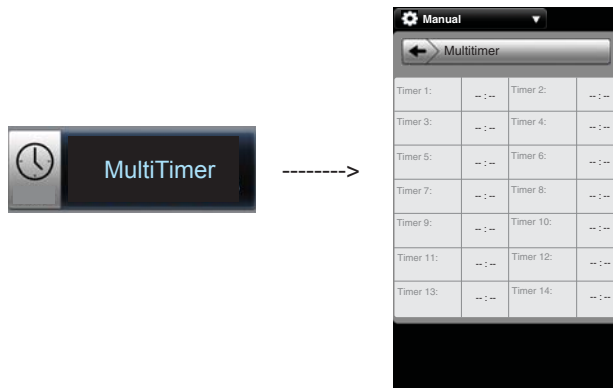

- 4) Timer1 and enter the recipe name (chicken, potatoes, etc).
- 5) --:-- and enter the time with the keypad.

For Timer2 and following, set as per Timer1.

To start the cooking cycle, open the oven door, load the food and close the door. The MultiTimer will start the countdown with the position having the shortest time setting.

At the end of each set cooking time the oven will sound a beep to indicate the type of food cooked. Open the door and remove the ready to serve product.

### 4.4.3 ECODELTA

 The ECO DELTA function enables cooking without harming the food with high temperatures; this ensures more gentle and more even cooking, with less weight loss. This is an advanced cooking method, where the oven compartment temperature varies according to the core temperature of the food. The operator can select a Delta value of between 20°C and 120°C; it is advisable to set a value between 20°C and 70°C, and a value between 10°C and 99°C for the Core Probe. The oven compartment temperature is automatically adjusted in order to always be higher than that in the core of the product.

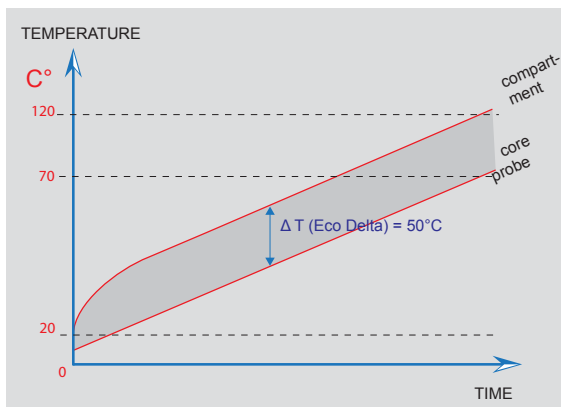





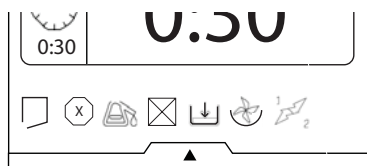

The graph shows an example with a set Delta of 50°C where the compartment temperature increases, keeping this difference of 50°C constant with respect to the core probe. This type of cooking is slower than the conventional cooking method but has the advantage of obtaining better product results and quality. This type of cooking is ideal for large pieces of meat.

### 4.4.4 INFORMATION AREA



The information area is the zone above the drawer that displays oven operation status with icons, subdivided into items. The figure above gives (starting from the left) the following:

-  door open
-  error x
-  descaling,
-  boiler preheating
-  fan speed,
-  reduced power

### 4.4.5 FSC (Food Safe Control)



The FOOD SAFE CONTROL (FSC) is a device enabling the microbiological SAFE condition of the food to be controlled during cooking. Depending on the chosen food category (HIGH risk or STANDARD risk), during cooking the FSC recognises the moment when the food reaches an acceptable sanitisation level for its SAFE consumption. The cooking results can be shown on the DISPLAY. The process requires strict compliance with proper food processing practices according to the rules of hygiene, before and after cooking. Cooking using the FSC does not sanitise bad or deteriorated food, which remains so even after cooking.

To use the FSC, set a cooking cycle as described above. Always insert the CORE PROBE even with TIMED cooking cycles.

The FSC is composed of 2 categories:



**FSC-STANDARD risk cooking:** for foods having a low contamination level. (e.g. whole pieces of beef)



**FSC-HIGH risk cooking:** for foods having a high contamination level. (e.g. roulades of meat, mince-meat, poultry, pork, fish)

Set the HIGH or STANDARD risk category in the UTILITIES drawer and press "START" to start.

In this way, cooking with the FSC starts; if the safe condition is reached during cooking, a confirmation will appear next to the FSC symbol:



F: 0.0

The Pasteurization factor F with value reached will also appear (if set).

If, on the other hand, cooking does not end in a safe condition, the FSC warns with a dialogue window and requests ending of the cycle automatically or manually by the user. At the end (in one way or the other), the following will appear:

- FSC ✓ for positive result
- FSC x for negative result

#### 4.3.6 CORE PROBE USE



##### (PRODUCT CORE TEMPERATURE CONTROL)

The core probe allows accurate control of the core temperature of the product being cooked. This enables setting of the required value (from 10°C to 99°C) and automatic stopping of cooking when that value is reached.



**Attention:** The core probe is a precision component. Absolutely avoid impacts, forcing when inserting, and pulling of the flexible cable (in particular when using the trolley-mounted structures). The warranty does not cover the replacement of core probes damaged by improper use.

After selecting the time icon select that of the core probe and press **START** to start the cycle.

- Wait until the compartment temperature field indicates reaching of preheating (the message LOAD appears).

- Open the door and introduce the product to be cooked.



**Attention!** Risk of burns.

**Always** open the door with caution when the oven is hot.

1) Remove the core probe "A" from its seat "B" and insert it in the product without forcing excessively, making sure the tip (the sensitive part) is positioned near the centre of the product.

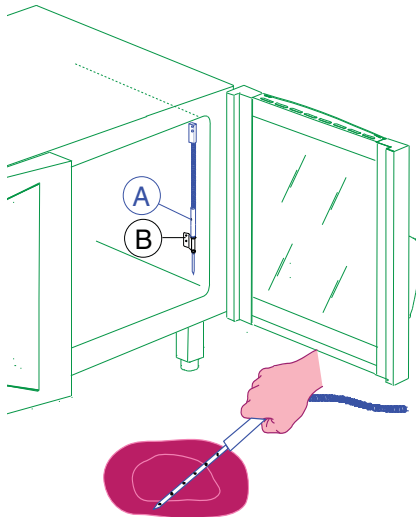

—————MULTIPOINT 6-sensor core probe

The oven is equipped with a MULTIPOINT core probe with 6 sensors along the entire stem, for correctly measuring the product core temperature even if the tip is not completely in the centre.

- Close the door and press the **START** button.

2) **Stopping the cycle.** When the required product core temperature is reached the oven stops automatically and the elapsed cooking cycle time is displayed.

3) **Core probe mode deactivation.** Set a cooking time on the Timer . This action automatically cuts out the core probe, whereas it is the opposite when the time is set. The core probe mode is also deactivated when the oven is switched off.

#### 4.3.7 END OF COOKING

At the end of the set time, the cooking cycle automatically stops and the oven buzzer sounds continuously. The display shows the message:



COOKING FINISHED !

Several parameters such as the following are also displayed:

- total time
- FSC a bar with relevant result will appear if set.

Open the door and remove the product.



**Attention!** Risk of burns.

**Always** open the door with caution when the oven is hot.

##### Notes:

- The buzzer can be stopped in advance by carrying out any operation on the control panel or by opening the door. The cooking cycle can be manually stopped by keeping the STOP button pressed for a few seconds. A cycle identical to that just completed can be repeated by pressing the START button again.



### 4.5 AUTOMATIC



The AUTOMATIC control mode is used for automatic cooking, by setting several simplified functions. This saves the operator from having to know the cooking parameter values (temperature, time, humidity) and makes the same type of cooking more equal.

Select AUTOMATIC from the Main Menu. The functions to be set are as follows:

- 1) food **TYPE**
- 2) cooking **MODE**
- 3) preset **COOKING**

There are also several parameters (which differ according to the cooking Mode used) to be confirmed or modified, such as :

- Form of food (whole or fillets)
- Cooking system (timed or with core probe)
- Food Browning level (low, medium, high)
- Food cooking level (rare, medium, well done)

#### 1) TYPE of food

- Red meat
- Minced meat
- Poultry
- Fish
- Vegetables
- Side dishes
- Bakery
- Dessert

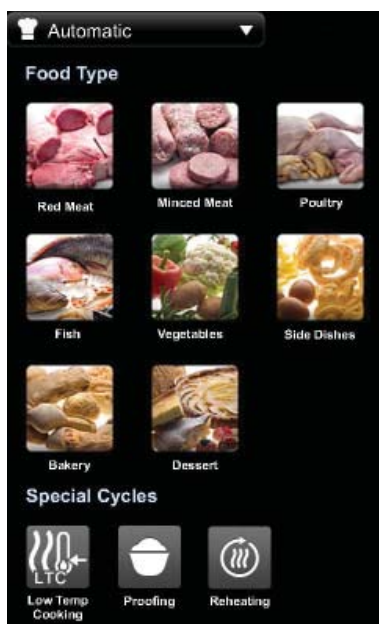

Also the Special Cycles can appear on the same screen.

#### 2) Cooking **MODE**

- (example)
- Baked
  - **Steamed**
  - Grilled
  - Gratin

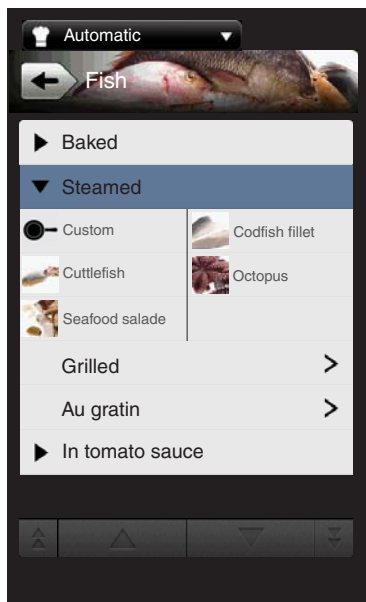

There are completely automatic cooking Modes where no parameter can be set (e.g. Red Meat \ Steam).

#### 3) Preset **COOKING** (example in figure)

##### ▼ Steamed

- Custom
- Cuttlefish
- Seafood salade
- Codfish fillet
- Octopus

Select one of the preset COOKING cycles to access the following example screen (Roast meat) where the cooking MODE parameters are shown with the preset (default) choices which can be modified if required.

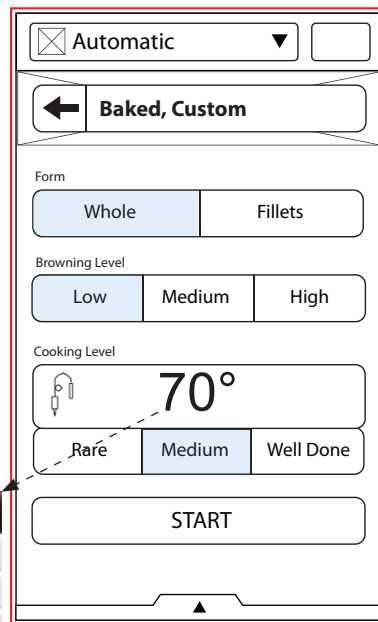

##### Form of food

- Whole
- Fillets

##### Browning Level

- Low
- Medium
- High

##### Cooking Level

- Rare
- Medium (70°)
- Well Done



keypad for adjusting the core probe temperature

### 4.3.9 SPECIAL CYCLES

The special cycles appear on the AUTOMATIC mode main screen, and are as follows:

- Low Temperature Cooking
- Proofing
- Reheating

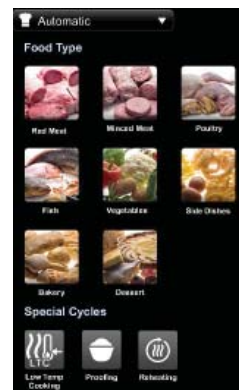

**LOW TEMPERATURE COOKING (EFS-LTC)**



Low temperature cooking is a specific cooking procedure particularly recommended for beef, such as entrecote, rump and fillet, but also good for other types of meat, including veal, lamb, venison, turkey, duck, pork, etc.

The meat cuts can be: roast-beef, shoulder, leg, saddle, steak with bone, rump, fillet, cutlets, etc.

The EFS-LTC is a completely automatic preset program, for obtaining tender and evenly cooked **food**.

The program comprises 4 main phases:  
PREHEAT, SEARING, MATURE, HOLD.

Select AUTOMATIC



Press the button

Set the program by entering the SEARING temperature, then enter the core probe final temperature and press



**During the Preheating phase it is advisable to place the core probe outside the compartment.**

After the PREHEAT phase (if necessary modify the compartment temperature already set) LOAD the food in the oven and insert the 6-sensor MULTIPOINT core probe (if necessary modify the core probe temperature already set).

Close the door to start the cooking cycle. The SEARING (dry heat sealing of the food) phase starts, followed by quick oven cooling (CoolDown) for subsequent slow cooking with the MATURE phase (for tenderising the meat). This is followed by the food temperature HOLD phase.

The entire EFS-LTC cycle can take several hours. One or more phases can be skipped, going to the next phase; this is useful, for example, when cooking is started (SEARING phase) with another appliance (e.g. frytop) and is to be completed with the oven (MATURE and HOLD phase). The MATURE phase cannot be skipped.

Main advantages:

- Excellent quality of the food.
- The standard LTC procedure guarantees repeatable results from year to year.
- Typical roast flavour; succulence of the food from the centre to the edge.
- Uniform colour and perfectly even cooking.
- Quick maturing process, time-saving and possibility of using fresh cuts of meat.
- Lower weight loss, 5-8% (depending on the quality of the food and core probe temperature setting).
- Considerable saving of portions for sale.
- Considerable energy-saving due to the EFS-LTC smart program.

**PROVING**



Proving is done like a normal cycle, setting the time and temperature.

Several utilities such as fan speed and programmed start can also be used.

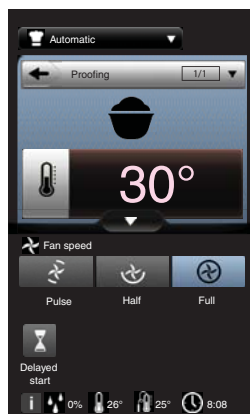

possibility: delayed start.

**REGENERATION**



When set, the regeneration program functions like a normal automatic cycle.

Select one of the following items:

- ▼ Pan
  - Custom
  - Core Probe
  - Timer
- ▼ Plate
  - Custom
  - Core Probe
  - Timer

Bread > (Timer)

Then, for example, by selecting Pan and Core Probe, the following figure appears:

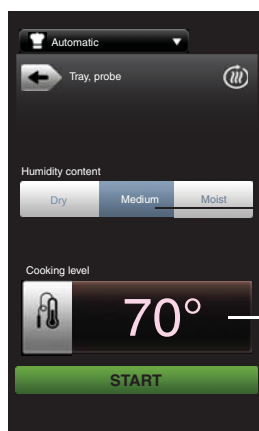

Medium selected

Core probe temperature (modifiable)

Lastly, press START to start the cycle.

## 4.6 PROGRAMS



The PROGRAMS control is used for already stored programs (or recipes), storing new ones and managing them inside a list.

program search

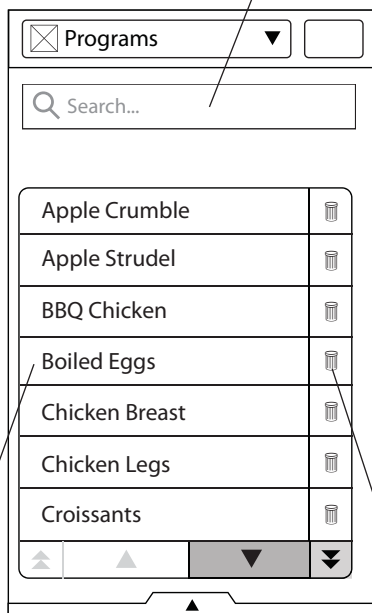

list of programs (example)

program cancel button (basket)

### 4.6.2 PROGRAM SEARCH

To find a program, enter the name using the keypad and press OK. The program with name closest to the one required will be highlighted on the list.

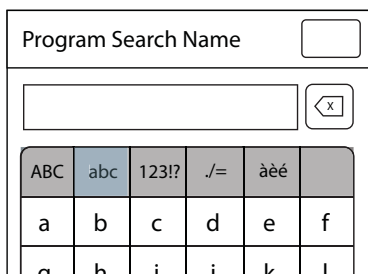

- ABC = Upper case letters
- abc = Lower case letters
- 123 = Numbers
- ./= = Symbols
- àèé = Other characters

### 4.6.3 START PROGRAM

Press the button of the Program Name on the Program List to access the Start screen and set the cooking parameters or start the program.

### 4.6.4 SAVE PROGRAM

Press this button to access the screen to save the program (or recipe); this is similar to the search by entering a name and confirming with OK.



## 4.6.5 LOAD / SAVE PROGRAMS

### LOAD recipes / programs in Oven from USB:

- 1) Insert the USB key.
- 2) Access the Programs menu
- 3) Open the drawer and select the symbol



(upload from USB)

- 4) Select the required file (e.g. UI40\_01.prg)

Wait for completion of the loading process.

**Attention:** Recipes / programs with the same name will be overwritten.

- 5) Press OK and remove the key.

### SAVE recipes / programs from Oven on USB:

- 1) Insert the USB key.
- 2) Access the Programs menu
- 3) Open the drawer and select the symbol



(save on USB)

Wait for completion of the save procedure.





- 4) Press OK and remove the key.

## 4.7 CLEANING



### CLEANING SYSTEM

This cleaning system carries out automatic compartment washing with suitable detergents according to the amount of grime detected; therefore the following 4 cycles have been provided for:

-  **CLEAN Soft**  
For still fresh grime from not very greasy cooking (e.g. with STEAM cycle)
-  **CLEAN Medium**  
For normal grime from greasy cooking.
-  **CLEAN Strong**  
For heavy grime from very greasy cooking (e.g. roast chicken, sausages).
-  **CLEAN Extra Strong**  
For heavy grime from very greasy cooking (e.g. roast chicken, sausages) even with dried residuals (encrustations).

To use these stored programs, proceed as follows:

#### Note 1:

Before cleaning the compartment with the CLEANING SYSTEM, remove the grease filter (if present).

The CLEANING SYSTEM cycle **starts** when the temperature has automatically reached **70°C in the compartment**.

Before carrying out a **CLEANING SYSTEM** cycle, make sure there is detergent in the containers (located under the control panel on models 6-10GN1/1 or independent in models 20GN1/1-2/1) and that it is of the required type, therefore see par. 6. CLEANING AND MAINTENANCE.

**Warning:**

In case of complete emptying of the detergent and/or rinse aid containers or emptying of their supply tubes, the CLEANING SYSTEM cycle must be started after firstly doing the CLEAN 1 cycle, then the same or other cycles. This operation allows the pipes to be refilled with the appropriate liquids and the cleaning cycles to be done correctly.

If the CLEANING SYSTEM is not used for long periods, it is necessary to do a cleaning cycle (CLEAN 1) with water instead of detergent and rinse aid before and afterwards, to flush the respective supply pumps.

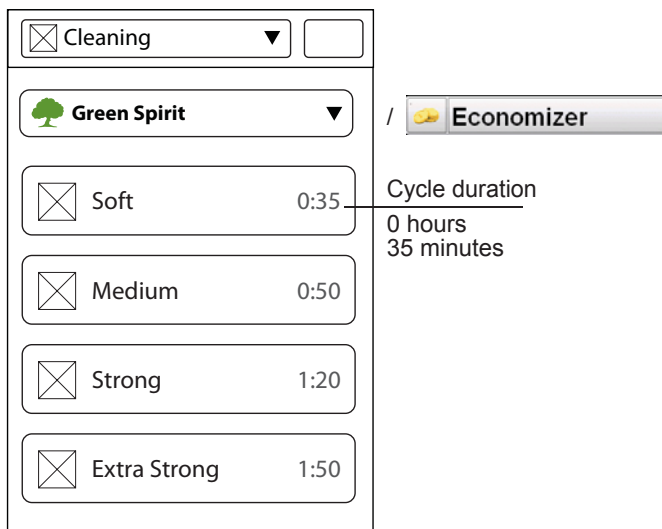

- Select a cleaning cycle (Medium is preset).

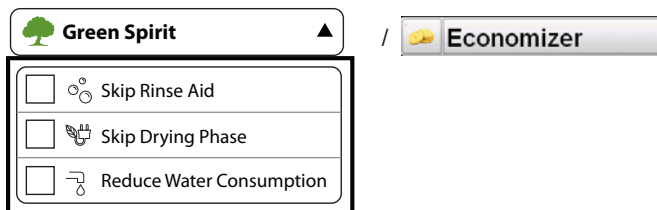

- If necessary, select one of the **Green Spirit / Economizer** functions.



 /  The "Green Spirit / Economizer" function enables use of the cleaning programs in respect for the environment.

-  If "Skip Rinse Aid" is selected, remember that the traces of scaling could remain in the compartment after cleaning.
-  For "Skip Drying Phase" it is necessary to open the door after cleaning, to air the oven.
-  For "Reduce Water Consumption" make sure an efficient ventilation system is installed. Reduction occurs by deactivation of fume suppression.

- Press START to start the cycle. If necessary, to stop the cleaning cycle press STOP for a few seconds.

## 4.8 SETTINGS

Select one of the following items:



### LANGUAGE



select the language

scroll list of languages

### INTERNATIONAL

set the language

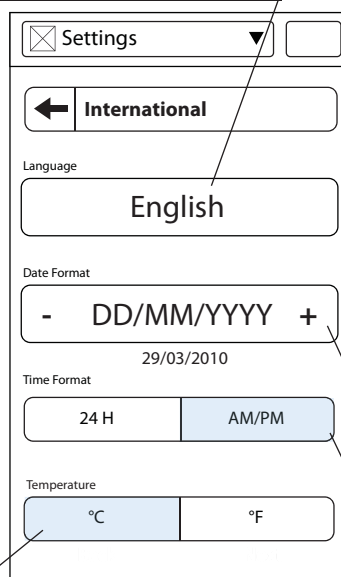

select the unit of measure for temperature (°C Celsius or Fahrenheit °F)

select the required time format

select the required date format (+/-)

**DATE**

**TIME**

Enter the date and time with the +/- sign (or with the keypad).

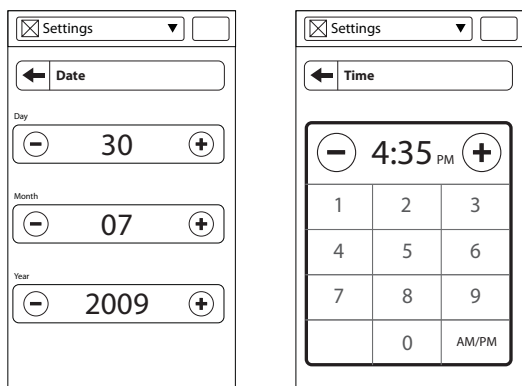

The example settings in the 2 figures are:

Date  
30 July 2009

Time  
4:35 p.m. (PM: Post Meridiem)

**FOOD SAFETY**

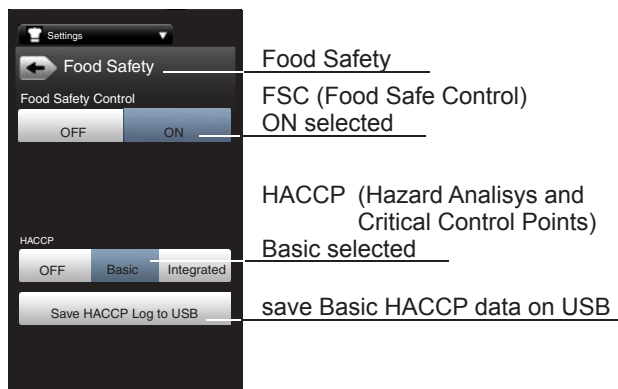

- FSC: see par. 4.4.4  
 - HACCP: according to the system required, cooking data can be recorded on USB key (Basic) or on Personal Computer (Integrated)

**GREEN SPIRIT**

- General
- Oven standby after: 0:30
  - No boiler preheat in stop
- Turn off lamps
- After 0.15 when not cooking
- Cleaning
- Skip rinse-aid
  - Skip drying phase
  - Reduce water consumption

**SOUNDS**

- Button pressure sounds
- Standard volume buzzer
- Loud volume buzzer

**MANUAL**

- Enable Manual
- General
- Show real and set value
  - Multi-phase cooking
  - Delayed start

- Timer/Temperature dialogs
- Short cooking
  - MultiTimer cooking
  - Eco-delta cooking

- Opzioni
- FSC
  - Show F value during cooking
  - Ask for FSC risk set on start
  - Cooking info in drawer

Hold

Default convection temp. 70°  
 Default steam temp. 70°  
 Probe temp. increase: Δ5°

Default cycle >

**PROGRAMS**

- Enable Programs
- Abilita salvataggio Programmi
- Enable Programs save

**AUTOMATIC**

- Enable Automatic
- Low Temperature Cooking
- Proving
- Regeneration

**CLEANING**

- Enable Cleaning
  - Force after 0:00 of cooking
- Default cycle
- Soft
  - Medium
  - Strong
  - Extra strong

**PASSWORD**

Set password

**AUTOSTART**

- Enable Autostart

**LOAD / SAVE CONFIGURATION**



**SAVE Oven Configuration on USB:**

- 1) Insert the USB key.
- 2) Access the Settings menu
- 3) Open the drawer and select the symbol

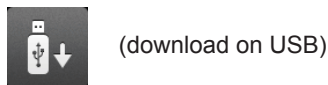

Wait for completion of the download process.

- 4) Press OK and remove the key.

**LOAD Oven Configuration from USB:**

- 1) Insert the USB key.
- 2) Access the Settings menu
- 3) Open the drawer and select the symbol

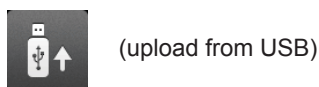

- 4) Select the required file (e.g. UI40\_01.zip)

Wait for completion of the loading process.

**Attention:** Recipes / programs with the same name will be overwritten.

- 5) Press OK and remove the key.

### 4.8.1 MAINTENANCE

#### BOILER DRAIN



**Manual draining of steam generator water:** press the button to drain water from the steam generator. (See 6.1 STEAM GENERATOR PERIODICAL MAINTENANCE)



**Attention! In order to prevent excessive scaling in the steam generator, make sure to:**

- respect the parameters regarding the water supply – see installation;
- always drain the generator at the end of each day.

#### GUIDED DESCALING



Guided descaling of the steam generator (boiler), with pure VINEGAR, facilitates the user in carrying out descaling operations.

For its use, refer to par. 6.1 STEAM GENERATOR PERIODICAL MAINTENANCE.

#### TECHNICAL ASSISTANCE



##### Technical assistance

By pressing this button a password is requested for accessing the area reserved for authorised technical personnel in order to edit the various oven operation parameters.

## 5. SWITCHING OFF IN CASE OF A FAULT

In case of a fault, deactivate the appliance:

- Turn off the automatic power switch located ahead of the appliance and close the water cocks.
- Contact an After-Sales Service Centre with qualified personnel authorised by the manufacturer.

#### IMPORTANT!

**With cooking cycle in progress, the signalling of an error code occurs with continuous sounding of the buzzer and stopping of the cycle.**

**In this case the appliance can be used in ways not involving the conditions that generated the error. Therefore just program the oven for a cycle that does not use the damaged component.**

**The After-Sales Service must be informed of the alarm code appearing on the display.**

## 6. CLEANING AND MAINTENANCE

- Turn off the automatic power switch located ahead of the appliance and close the water cocks.

At the end of each day, clean the oven compartment using suitable products and following the supplier's recommendations.

- Do not clean the appliance with direct jets of water.
- Do not use products containing chlorine (chlorine bleach, hydrochloric acid, etc.), even if diluted, to clean the steel parts.
- Do not use corrosive substances (e.g. muriatic acid) to clean the floor under the appliance.

MAINTENANCE, INSPECTIONS, CHECKS AND CLEANING	FREQUENCY
<b>Routine cleaning</b>	<b>Daily</b>
General cleaning of machine and surrounding area	

<b>Mechanical protection devices</b>	<b>Monthly</b>
Check condition and for any deformation, loosening or removed parts.	
<b>Control and Machine structure</b>	<b>Yearly</b>
Check mechanical part for any breakage or deformation, tightening of screws. Check readability and condition of words, stickers and symbols and restore if necessary.	
Electrical connection cable and plug	<b>Yearly</b>
Check connection cable (replace it if necessary) and plug.	

The appliance (except for some models) has an automatic compartment cleaning programme called CLEANING SYSTEM; for its use see par. 4.7 CLEANING.

The CLEANING SYSTEM program requires detergents, therefore fill the DETERGENT CONTAINER - max. 5 litres (on RIGHT with RED cap) and the RINSE AID CONTAINER - max. 1.2 litres (on LEFT with BLUE cap) located under the control panel:

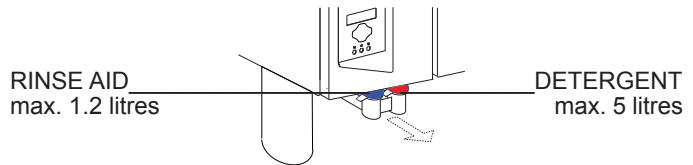

Nei mod. 20GN1/1-2/1 collegare i tubetti (in dotazione) sul lato sinistro del forno (attacco dx simbolo ROSSO per il DETERSIVO, attacco sx simbolo BLU per il BRILLANTANTE) ed inserire le altre estremità nei propri contenitori (non in dotazione) riempiti uno di DETERSIVO e l'altro di BRILLANTANTE.

The detergents to be used are:

- ECOLAB "Oven Cleaner Power" type detergent (**not in gel**)
- ECOLAB "Oven Cleaner Power" type rinse aid (**not in gel**)

#### Notes:

- Oven compartment cleaning is not ensured if a type of detergent or rinse aid different from that specified above is used.
- **The warranty does not cover damage caused by** the use of detergents or rinse aids with characteristics different from those recommended by us (e.g. containing chlorine, etc.).
- Do not use detergent or rinse aid **powders dissolved in water** since they could damage the appliance's internal components.
- Detergent and rinse aid containers, independent of the oven, **must not be placed** higher than the appliance support surface (for model 6 GN they must be placed lower than the oven support top).



**Attention:** Contact with chemical substances (e.g. detergent, rinse aid, scale remover, etc.) without taking adequate safety precautions. Therefore always refer to the safety cards and labels on the products used.

To facilitate oven compartment cleaning, remove the rack trolley guides from the bottom of the oven and open the suction wall.

- To open the oven compartment **suction wall A** (Fig. 2) proceed as follows:
  - switch the oven off and disconnect the power to the appliance;
  - undo (1a) screw B2 completely with a screwdriver,
  - insert the tip of a screwdriver in slot B and prise (1b) inwards to open the wall, unhooking it from the pegs B1 at the back.

If required, **completely remove** suction wall:  
 - unscrew (2) nut C1 with a hexagon wrench.  
 - lift (3) the suction wall and remove it (4) from the bottom pin C of the oven compartment;  
 - lower (5) the wall to release it from the top pin D and completely remove it (6).

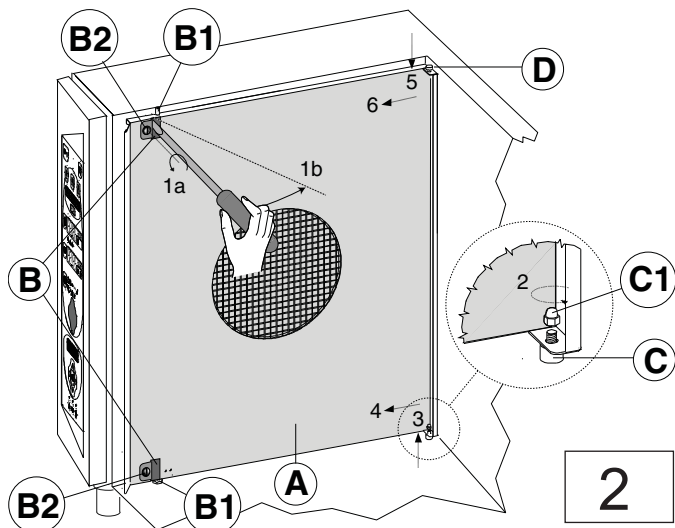

To refit the wall, repeat the steps in reverse order and retighten nut C1.

- If present, clean the oven compartment **grease filter** (not supplied) at least every three cooking cycles.
- If present, clean the **air filter** (not supplied) at least once a month, removing it from under the **control panel**. Non-compliance with the above will result in filter inefficiency and produce anomalous effects in cooking.
- Clean the stainless steel parts every day using lukewarm soapy water, rinsing with plenty of water and drying thoroughly.
- Do not clean the stainless steel with steel wool, brushes or scrapers in common steel, as they could deposit ferrous particles which oxidise, causing rust spots.
- Whenever the appliance is not used for long periods:
  - Disconnect the power supply and close the water;
  - go over all steel surfaces vigorously with a cloth moistened with paraffin oil in order to create a protective film;
  - Periodically air the premises.

### 6.1 STEAM GENERATOR PERIODICAL MAINTENANCE

• In case of excessive scale in the steam generator the following light comes on



signalling the need to carry out descaling.  
**The manufacturer declines any liability if these prescriptions are not respected; also, the warranty does not cover the repair or replacement of components damaged by scale whenever the required supply water characteristics are not respected (see the relevant section).**

Descaling can be carried out using two methods:  
 - with vinegar, concentration 100%;  
 - with chemical descaler (carefully following the instructions given below).

**The appliance must be switched on for these operations.**

### 6.1.2 METHOD WITH 100% VINEGAR

The method with VINEGAR is carried out through GUIDED DESCALING.

Select "Settings" from the menu and press the button:



Guided descaling

Follow the steps indicated on the oven display, as listed below:

- 1/5) Make sure the oven compartment is empty
- 2/5) Boiler preparation (emptying): wait
- 3/5) Filling: fill the boiler with pure vinegar via the upper cap until a beep sounds, indicating quantity reached. Given below are the approximate quantities of vinegar (in litres) required for each oven model:

	6-1/1	10-1/1	20-1/1	6-2/1	10-2/1	20-2/1
gas	5	9	9	6	9	23
electric	5	5	8	7	8	15

- 4/5) Descaling: wait (the remaining time, including rinse, is indicated).
- 5/5) Rinse: wait (boiler and compartment are rinsed with water and steam); this phase is NOT blockable.

In case of a power failure or oven switch-off during descaling phases 3 and 4, rinse phase 5 will ensue. If it occurs also in this last phase, the rinse will be carried out at the next oven switch-on.

### 6.1.3 METHOD WITH CHEMICAL DESCALER

Descaling with chemical products must be carried out according to the supplier's instructions (the detergent supplier firms). For example, using the ECOLAB "STRIP-A-WAY" type descaler, proceed as follows:

- 1) Close the water supply cock.
  - 2) Completely drain the steam generator by pressing the following button
- 
- 3) After one minute close the steam generator drain (press the above-mentioned button).
  - 4) Remove the plastic cap of the generator access tube and introduce the following quantity of liquid through the same:
    - 2 litres of descaling liquid plus 6 litres of water (6-10gn)
    - 4.5 litres of descaling liquid plus 11.5 litres of water (20gn)
  - 5) Open the water cock.
  - 6) Operate the oven STEAM cycle for 12 minutes.
  - 7) Switch off and wait 40 minutes.
  - 8) Switch the oven on again for another 2 minutes.
  - 9) Switch off and wait 60 minutes.
  - 10) With the water cock open, reopen the generator drain valve to empty it (press the above-mentioned button).
  - 11) Switch the oven off.
  - 12) Rinse the inside of the generator with a rubber hose inserted in the pipe, until clean water comes out the drain.
  - 13) Refit the cap and close the steam generator drain (press the above-mentioned button).

**IMPORTANT -1**

Carefully rinse the inside of the generator with a rubber hose inserted through the generator access pipe, to remove all traces of descaler.

- Refit the cap and close the steam generator drain (pushbutton or lever).

After these procedures it is advisable to operate the oven empty, in STEAM cycle, for 30 minutes.

**IMPORTANT - 2**

If the water cock is not easily accessible, to empty the boiler proceed as follows:

- 1) Open the boiler drain valve with the special pushbutton.
- 2) Wait 2 minutes and switch the oven off; the drain valve will automatically close.

**6.2 REPLACING CONSUMABLE COMPONENTS****Replacing the oven compartment lamp (Fig. 3)**

To replace the oven compartment lamp, if burnt out, proceed as follows:

- Disconnect the power to the appliance.
- Undo the 4 screws fixing the light fitting ring nut "A" and remove the glass "V" together with seal "G".
- Remove the halogen lamp "L" and replace it with another one having the same characteristics (12V - 10W - 300°C), using a clean cloth or paper to avoid direct contact with fingers.
- Refit the protection glass, correctly inserted inside the seal, in the lamp compartment and fix the ring nut by retightening the 4 screws, after smearing the seal with food-grade silicone grease.

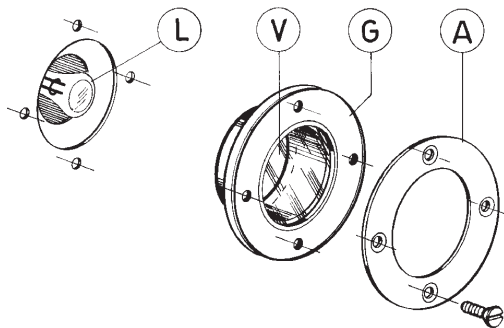

3

**Replacing door seals (Fig. 4)**

**NB:** The door seal is a component that can become worn over time. It is advisable to replace it whenever any hardening or breakage is noticed.

To replace it, proceed as follows:

- Remove the seal from its seat and clean the latter of any traces of silicone.
- Apply a bead of silicone sealant at point 1 along the inside profile of the seal seat.
- Insert the new seal along the entire seat.

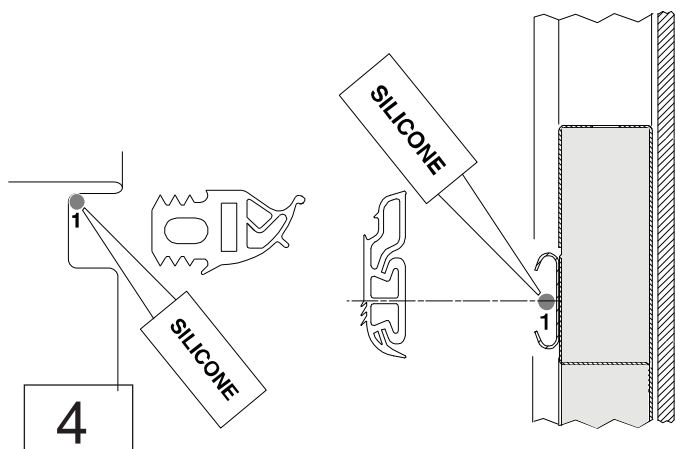

4

**6.3 PARTICULAR CLEANING****Discharge system cleaning and efficiency check**

Periodically clean the drain pipe, checking for any obstructions involving the draining of water.

**Cleaning the door internal glass (Fig. 5)**

These operations must be done with the door glass cold, without using abrasive detergents or rags.

The interspace surfaces are accessed by opening the internal glass hinged on the door.

- With the door open, press the two top and bottom retaining clips F and open the internal glass.

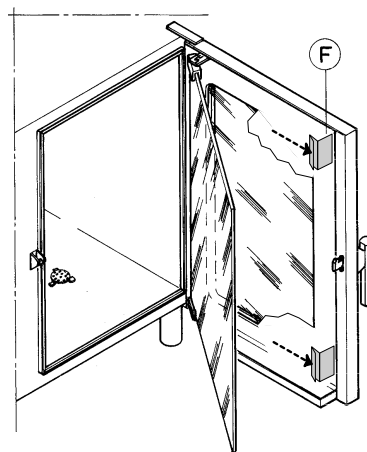

5

After cleaning, close the internal glass against the rubbers.

**Cleaning the CLEANING SYSTEM rotating jet (Fig. 6)**

It is advisable to clean the jet in case of:

- long periods of CLEANING SYSTEM disuse
- difficulty in wash arm rotation (probable nozzle obstruction)
- use of very hard water.

If the nozzles are completely obstructed, use the tip of a knife to remove any encrustations.

- Extract (without removing) the retaining clip A from the middle block of the jet. For this operation insert the tip of a screwdriver in the part indicated by the arrow and turn it from the vertical to the horizontal position as shown in the figure.
- Remove the jet from the rotation pin.

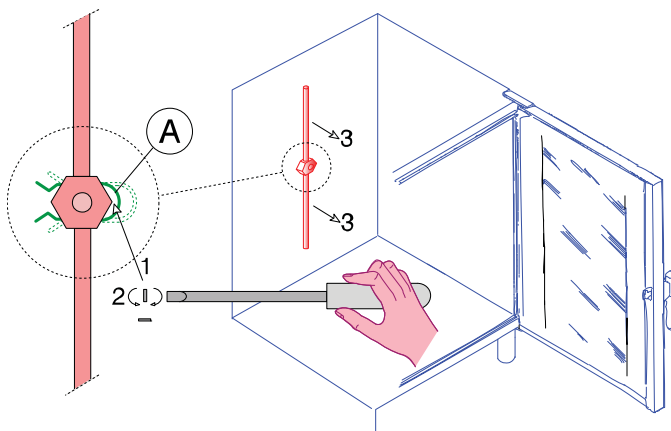

6

- Place the rotating jet in a bowl containing descaler, leave over night then rinse with plenty of water.
- Refit the jet, inserting it on the rotation pin and pressing the retaining clip into its original position.