



Product Catalog Rolko NA MSRP

**Mobility &
Positioning
Products**

**Customized
Products**

Daily Aids

2024-01

CONTENTS

Company	3
Information Key	4
Team	5

MOBILITY

Frog Legs Casters/LED Wheels	6-7
Manual Tires iMPAC	8
Manual Tires Schwalbe	9
Tubes, Inlets and RimBands	10
Poly Tires	11
Push Rims Vega	12
Push Rims Perigon and Accessories	13
Wheel Accessories	14
Wheel Brakes and Accessories	15
Power Chair Casters And Wheels	16-18
Power Chair Tires	19

POSITIONING

Seatbelts	20-22
Arm Supports	23
Modular Arm Shell System HEMI	24-25
Leg Supports	26
Abductor Wedges and Supports	27
Head Supports	28

ACCESSORIES

Hand Grips Easy Push	29
Transfer Aids EasyTRANSFER <small>Rolko</small>	30
Umbrella and Walker Belts PROTEKTOR	31
Bags and Wheel Bags BAG <small>Rolko</small>	32
Scooter Accessories	33
Thermo Wear Thermo <small>Rolko</small>	34-35

Rolko North America Inc. is a subsidiary of Rolko Kohlgrüber GmbH, a leading manufacturer and supplier of components and accessories for the rehabilitation market as well as mobility solutions for companies from various industrial sectors. Rolko's headquarters is in Germany, with subsidiaries in Denmark, the Netherlands and the USA as well as a production plant in Asia, the company ensures advice, support and delivery around the globe.

Manufacturers and specialist retailers from over 80 countries rely on the extensive delivery program of Rolko, which includes wheels, tires, puncture-proof solutions and other components for wheelchairs and rehabilitation equipment. Rolko also offers rehabilitations aids such as wheelchair ramps, weather protection, transfer aids, seating and positioning aids, and accessories for scooters, power and manual wheelchairs. With over 30 years of industry experience, Rolko is here to meet your wheelchair needs.

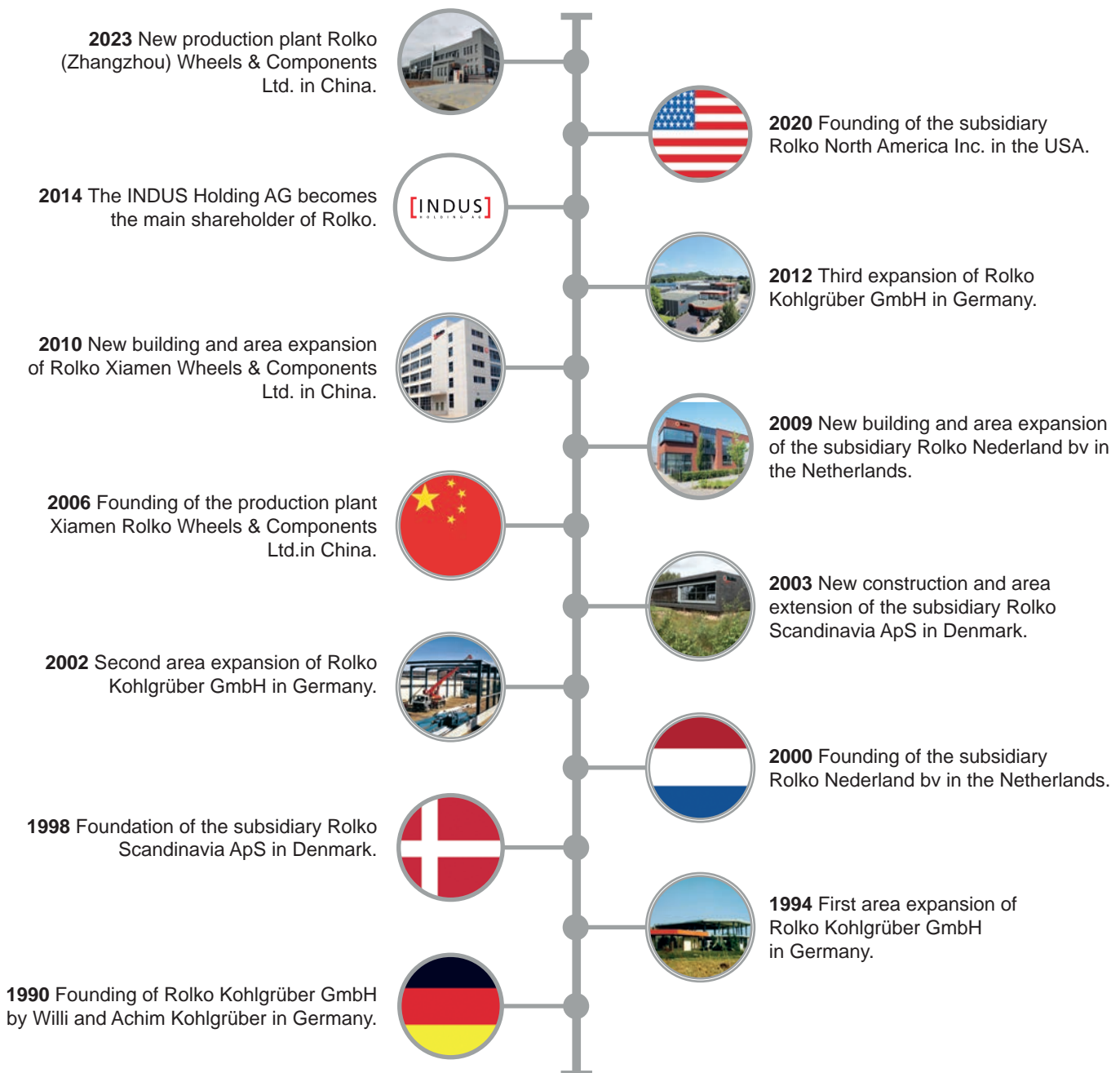



Tire Color



Rim Color



Bore / Inner
Diameter

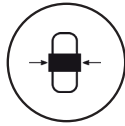

Hub Length

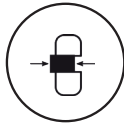

Mounting
Length



Rim Base
Width



Tire Tread



Gap Between
Tabs



Net Weight
(LB)

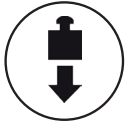

Load Capacity
(Lb)



Max. Air Pressure
(Psi)

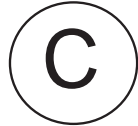

Color



Depth



Installation
Length



Tire Width / Inner
Diameter



Height



Length



Reference



Seat Width



Width



Max. Speed
Miles per hour



ALL MSRPs
Represent US Currency

NOTE: All pricing is based on MSRP for all products.
Contact us for your company's contracted pricing.

All specified dimensions are approximate. All illustrations are non-binding.
We reserve the right to make unpublished/unannounced modifications.

We deliver according to our latest general terms and conditions.
Not all products listed are available from stock.

All images, graphics and texts in our catalog are copyright © protected.
Any use requires our prior written permission.



Florian Pixa
President

Email: fpixa@rolko.com
Office: (641) 351-6400



Jill Brown
Vice President

Email: jill.brown@rolkona.com
Office: (641) 351-6400
Cellular: (641) 208-6447



Javier Nuñez
Director of Strategic Development

Email: javier.nuñez@rolkona.com
Office: (641) 351-6400
Celluar: (641) 208-4077





Brittany Small
Customer Service Manager



Email: brittany.small@rolkona.com
Office: (641) 351-6400
Cellular: (641) 919-2568





Silver Aluminum Lightweight Rim With Poly Tire

SIZE			Product Number	MSRP
3x1.4"	1"	8mm	MCLT3SB	89.95
4x1"	1"	8mm	MCC24SB	89.95
4x1.25"	1"	8mm	MCOE4SB	92.95
4x1.4"	1"	8mm	MCLT4SB	97.95
5x1"	1"	8mm	MCC25SB	94.95
5x1.25"	1"	8mm	MCOE5SB	99.95
5x1.4"	1"	8mm	MCLT5SB	99.95
6x1.4"	1"	8mm	MCLT6SB	109.95

Black Aluminum Lightweight Rim With Poly Tire

SIZE			Product Number	MSRP
3x1.4"	1"	8mm	MCLT3BB	89.95
4x1"	1"	8mm	MCC24BB	89.95
4x1.25"	1"	8mm	MCOE4BB	92.95
4x1.4"	1"	8mm	MCLT4BB	97.95
5x1"	1"	8mm	MCC25BB	94.95
5x1.25"	1"	8mm	MCOE5BB	99.95
5x1.4"	1"	8mm	MCLT5BB	99.95
6x1.4"	1"	8mm	MCLT6BB	109.95

Ti-Lite Wheels Aluminum Lightweight Rim With Poly Tire

SIZE				Product Number	MSRP
4x1.4"	1"	3/8"	Silver	MCTL4SB	99.95
5x1.4"	1"	3/8"	Silver	MCTL5SB	109.95
6x1.4"	1"	3/8"	Silver	MCTL6SB	119.95
4x1.4"	1"	3/8"	Black	MCTL4BB	99.95
5x1.4"	1"	3/8"	Black	MCTL5BB	109.95
6x1.4"	1"	3/8"	Black	MCTL6BB	119.95

Composite Lightweight Rims With Polyurethane Tire

SIZE			Product Number	MSRP
4x1.4"	1"	8mm	MCAG4BB	49.95
5x1.4"	1"	8mm	MCAG5BB	49.95
6x1.4"	1"	8mm	MCAG6BB	59.95

Technician Notes

Three-spoke ultralight aluminum caster wheels.

Custom-made 6061-T6 aircraft grade aluminum wheel that is machine-lathed for a perfect balance.

Priority, highly-resilient solid urethane tread is designed to minimize energy loss and absorb vibration.

Spherical arched-tread design improves pivotability for effortless turns and enhanced stability.

Extra width better distributes downward pressure allowing the wheel to maintain higher flotation and significantly reduces immersion into carpet, gravel, etc.

Technician Notes

Same great benefits of traditional Frog Legs wheels but specially designed for Ti-Lite wheels



Technician Notes

An economic alternative made with composite. Still with all the benefits of the Frog Legs wheel design.



Frog Legs and Skate Wheels



Blue Aluminum Lightweight Rim With Poly Tire

SIZE			Product Number	MSRP
4x1"	1"	8mm	MCC24UB	95.95
4x1.4"	1"	8mm	MCLT4UB	99.95
5x1"	1"	8mm	MCC25UB	99.95
5x1.4"	1"	8mm	MCLT5UB	107.95

**Available in other colors. Contact us for more details.





Red Aluminum Lightweight Rim With Poly Tire

SIZE			Product Number	MSRP
4x1"	1"	8mm	MCC24RB	95.95
4x1.4"	1"	8mm	MCLT4RB	99.95
5x1"	1"	8mm	MCC25RB	99.95
5x1.4"	1"	8mm	MCLT5RB	107.95

**Available in other colors. Contact us for more details.



Orange Aluminum Lightweight Rim With Poly Tire

SIZE			Product Number	MSRP
4x1"	1"	8mm	MCC24OB	95.95
4x1.4"	1"	8mm	MCLT4OB	99.95
5x1"	1"	8mm	MCC25OB	99.95
5x1.4"	1"	8mm	MCLT5OB	107.95

**Available in other colors. Contact us for more details.









Skate Wheels With Plastic Rim and Poly Tire With Four LED Lights

SIZE			Product Number	MSRP
80mm	1"	8mm	MCLED3	59.95
100mm	1"	8mm	MCLED4	69.95
125mm	1"	8mm	MCLED5	69.95









IMPAC

Grey Tires, Standard

Size	ETRTO		BAR			Product Number	MSRP
20x1.3/8"	37-451	60 kg	60 psi		R-124	MD20WG	24.95
22x1.3/8"	37-501	65 kg	60 psi		R-124	MD22WG	24.95
24x1.3/8"	37-540	75 kg	60 psi		R-124	MD24WG	24.95

Black Tire, Non-Marking

Size	ETRTO		BAR			Product Number	MSRP
20x1.3/8"	37-451	60 kg	60 psi		R-124	MD20WB	32.95
22x1.3/8"	37-501	65 kg	60 psi		R-124	MD22WB	32.95
24x1.3/8"	37-540	75 kg	60 psi		R-124	MD24WB	32.95

Grey Tire, Super Light Tread

Size	ETRTO		BAR			Product Number	MSRP
24x1"	25-540	60 kg	100 psi		R-103	MD24NHPG	24.95

Black Tire, Non-Marking, Super Light Tread

Size	ETRTO		BAR			Product Number	MSRP
24x1"	25-540	60 kg	100 psi		R-103	MD24NHPB	39.95

Tread Patterns

R-103

R-103

R-124

R-124



Depending On The Floor Material And Color As Well As Braking Effect, Black Pneumatic Tires May Rarely Leave Marks In The Flooring. Note The Instructions For Use From The Flooring Manufacturer.



Rolko: Official Supplier of Schwalbe Tires in North America

Contact us for additional sizes and colors.

RightRun: Entry level model with effective puncture protection layer, Easy grip, hand-friendly 2grip side walls, and attractive two color compound.

Size	ETRTO	TIRE COLOR	BAR	Weight	Product Number	MSRP
24X1"	25-540	● / ●	6-10	130lbs	MD24RRG	37.95
24x1"	25-540	● / ●	6-10	130lbs	MD24RRB	39.95
25x1"	23-559	● / ●	6-10	130lbs	MD25RRG	37.95
26x1"	25-590	● / ●	6-10	143lbs	MD26RRG	39.95



Marathon Plus Evolution: Punctures are a thing of the past! Flat-less smart guard. Durable rubber compound that does not leave marks with easy grip. The tire with the lowest rolling resistance on the market!

Size	ETRTO	TIRE COLOR	BAR	Weight	Product Number	MSRP
24x1"	25-540	●	6-10	130lbs	MD24MP	95.00
24x1"	25-540	●/Reflex	6-10	130lbs	MD24MPR	102.00
24x1.3/8"	37-540	●	3, 5-6	165lbs	MD24MPW	102.00
25x1"	25-559	●	6-10	130lbs	MD25MP	99.95
26x1"	25-590	●	6-10	143lbs	MD26MP	102.00



One: Fast and reliable folding Schwalbe tire. Stylish design and Wheelstar rubber compound, high level of puncture resistance due to the V-Guard fiber.

Size	ETRTO	TIRE COLOR	BAR	Weight	Product Number	MSRP
24x1"	25-540	●/Reflex	6-9	154lbs	MD24ONE	129,95
25x1"	25-559	●/Reflex	6-9	154lbs	MD25ONE	129,95



DownTown: All-rounder with grip and comfort. Puncture protection belt kevlar guard and easy grip.

Size	ETRTO	TIRE COLOR	BAR	Weight	Product Number	MSRP
24x1"	25-540	●	6-10	130lbs	MD24DTS	49.95
24x1.3/8"	37-540	● / ●	3, 5-6	165lbs	MD24DTW	59.95



Tubes

Tire Tubes With Car or French Valve

SIZE	ETRTO	VALVE	Product Number	MSRP
7x1.3/4"	47-93	Car Valve 90 degree	CS8X290	9.95
20x1"	25-451	Car Valve Schrader	MS20NAV	8.95
20x1.3/8"	37-451	Car Valve Schrader	MS20WAV	8.95
22x1.3/8"	37-489	Car Valve Schrader	MS22WAV	8.95
24x1"	25-540	Car Valve Schrader	MS24NAV	8.95
24x1"	25-540	Presta/French Valve	MS24NFV	9.95
24x1.3/8"	37-540	Car Valve Schrader	MS24WAV	8.95
25x1"	25-559	Car Valve Schrader	MS25NAV	8.95
25x1"	20-559	Presta/French Valve	MS25NFV	9.95
26x1"	25-590	Car Valve Schrader	MS26NAV	8.95
26x1"	25-590	Presta/French Valve	MS26NFV	9.95
26x1.3/8"	37-590	Car Valve Schrader	MS26WAV	8.95

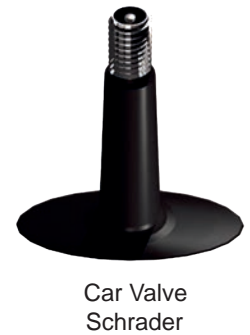
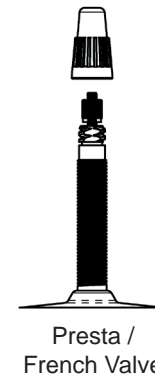

Please Contact Us For Additional Sizes

Tire Inlays

Polyurethane Foam Inlay To Insert Into Tires

SIZE		Product Number	MSRP
24x1"		MA24N	49.95
24x1.3/8"		MA24W	49.95

Please Contact Us For Additional Sizes



Rim Bands

Rim Bands Protect The Inner Tubes Against Damages From The Spoke Ends In The Inner Rim. Width Size In Milimeters. Sold Individually.

SIZE	ETRTO	W	Product Number	MSRP
Standard	22-406	13mm	FB20W	2.95
Standard	20-89/507	12mm	FB22W	2.95
Standard	18-540	14mm	FB24W	2.95
Standard	20-590	13mm	FB26W	2.95
Polyurethane	16-540	16mm	FB24N	6.95
Polyurethane	20-559	19mm	FB25N	6.95



Polyurethane Tires For Manual Wheelchairs

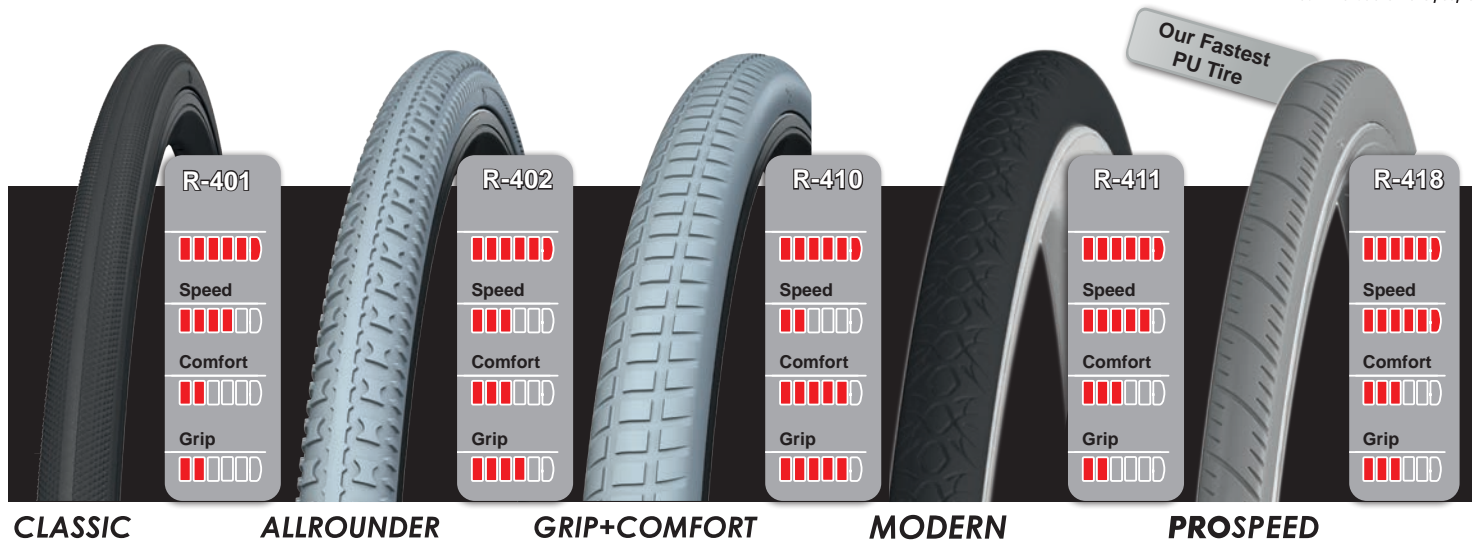

SIZE	ETRTO	THE COLOR			Product Number	MSRP
20x1"	25-451	○	R-401		MU20NG16	32.95
20x1"	25-451	○	R-401		MU20NG21	32.95
20x1.3/8"	37-451	○	R-402		MU20WG	32.95
22x1"	25-489	●	R-401		MU22NB16	39.95
22x1"	25-489	●	R-411		MU22YB16	39.95
22x1.3/8"	37-501	○	R-402		MU22WG	32.95
22x1.3/8"	37-501	●	R-401		MU22WB	39.95
24x1"	25-540	●	R-401		MU24NB16	39.95
24x1"	25-540	●	R-411		MU24YB16	39.95
24x1"	25-540	●	R-401		MU24NB20	39.95
24x1"	25-540	●	R-418	PROSPEED	MU24PSB	65.95
24x1.3/8"	37-540	●	R-410		MU24WB	59.95
24x1.3/8"	37-540	○	R-402		MU24WG	36.95
25x1"	25-559	●	R-401		MU25NB	39.95
25x1"	25-559	●	R-418	PROSPEED	MU25PSB	65.95
25x1"	25-559	○	R-418	PROSPEED	MU25PSG	59.95
26x1"	25-590	●	R-401		MU26NB	59.95
26x1.3/8"	37-590	○	R-402		MU26WG	59.95

Tire Accessories

Plastic Tire Lever For An Easy Assembly of PU and Pneumatic Tires on Rims

Product Number	MSRP
MEPURO	9.95



9.8"L 2.5"W 0.5"Back



VEGA Push Rims



Technician Notes

Soft Rims have a coating for easy grip and comfort.



Push Rim, Ergonomic, Oval, Anodized Aluminum, Black

	SIZE	TABS	Product Number	MSRP
Natural Fit	24"	6	GF24EV	179.95
Natural Fit	25"	6	GF25EV	179.95
Natural Fit, Vinyl Dip	24"	6	GF24QV	189.95
Natural Fit, Vinyl Dip	25"	6	GF25QV	189.95

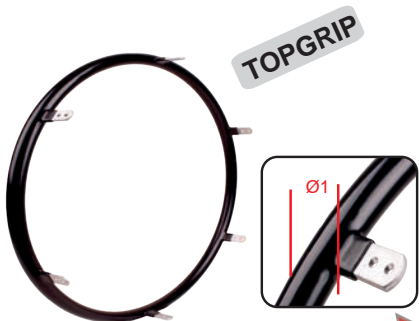

Push Rim Made Of Aluminum, Extra-Soft Coating For More Grip

Size			TABS	Ø1	Product Number	MSRP
24"	545	523*	6	20	GF24QG	159.95

*Space between tabs



Size			TABS	Ø1	Product Number	MSRP
24"	545	523*	5	20	G24AL5S	159.95

*Space between tabs

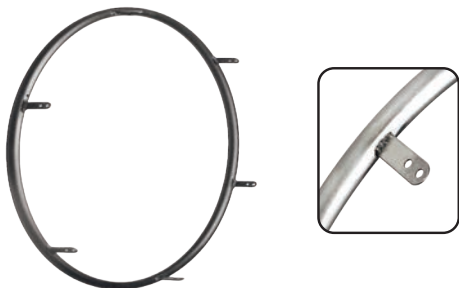

Push Rim Made of Aluminum, Silver or Black Anodized

Size			TABS	Ø1	COLOR	Product Number	MSRP
24"	542	523*	6	20	Silver	GF24SA	99.95
24"	542	523*	6	20	Black	GF24BA	99.95

*Space between tabs

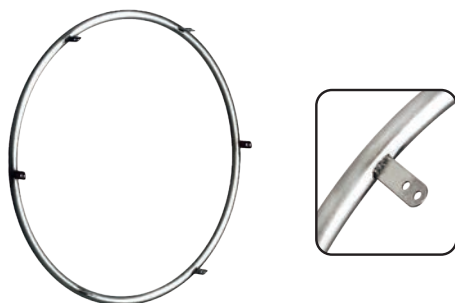

Push Rim Made of Stainless Steel

Size			TABS	Ø1	Product Number	MSRP
24"	540	524*	6	20	GF24SS	99.95

*Space between tabs

Push Rims And Accessories

Fixation Kit:

6 Pan Head Screws M5x10 mm, 6 Hexagon Nuts M5

Product Number	MSRP
UM5GFKIT	9.95



Comfortable Push Rim Covers Made Of Silicone, Supersoft, Smooth. Sold Individually

Size		Ø1	Product Number	MSRP
20"	412-424	16-21	SGR201	59.95
22"	486-501	16-21	SGR221	59.95
24"	519-532	16-21	SGR241	59.95
25"	533-559	16-21	SGR251	59.95
26"	571-590	16-21	SGR261	59.95

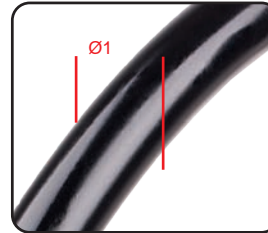



Perigon



36 SPOKE WHEEL



Black Aluminum Double Wall Rim, With 36 Black Spokes. Black Aluminum Push Rims, Available With A Variety of Tire Options Compatible with TiLite, Ki Mobility and Sunrise

Pneumatic Tire Schwalbe RunRight

	SIZE				Product Number	MSRP
Black	24x1"	540	2"	1/2"	H224BBB2	279.95



Pneumatic Tire With Airless Insert

	SIZE				Product Number	MSRP
Black	24x1.3/8"	540	2"	1/2"	H224BBB1	279.95
Grey	24x1.3/8"	540	2"	1/2"	H224BBB3	279.95



Quick Release Axle FLY, Large Button,
Easy Release For Those With Limited Dexterity

L	Ø	Product Number	MSRP
3.9"	1/2"	QRA99FLY	49.95
4"	1/2"	QRA104FLY	49.95
4.3"	1/2"	QRA110FLY	49.95
4.6"	1/2"	QRA116FLY	49.95

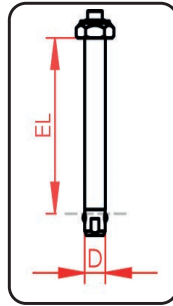

Button Back



Button Front

Quick Release Axle

L	Ø	Product Number	MSRP
4"	1/2"	QRA104VA	39.95
4.3"	1/2"	QRA110VA	39.95
1.8"	1/2"	QRA123VA	39.95



ABEC 3, Double Sealed Precision Bearings, Set with 4 pcs.

Ø	Ø	W	Type	Product Number	MSRP
28mm	12mm	8mm	6001-2RS	KG6001	19.95
1 1/8"	1/2"	5/16"	R8-2RS	KGR82RS	19.95
7/8"	3/8"	9/32"	R6-2RS	KGR62RS	19.95
22mm	8mm	7mm	608-2RS	KG6083	16.95
29/32"	7/16"	5/16"	1607-2RS	KG1607	19.95



Spoke Reflector. Approximately 3"

W	Product Number	MSRP
3"	REF2	2.95

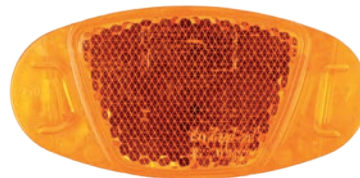

Bearing Cap

W	Product Number	MSRP
1"	KNROCAP	1.95



Wheel Brakes and Accessories

Composite Brakes Push To Lock

	Product Number	MSRP
Right	WL20R	36.95
Left	WL20L	36.95
Kit	WL20KIT	69.95



Kit: Left & Right Brake, Clamps Sold Separately.

Composite Brakes Scissor Lock

	Product Number	MSRP
Right	WL01R	39.95
Left	WL01L	39.95
Kit	WL01KIT	79.95



Kit: Left & Right Brake, Clamps Sold Separately.

Aluminum Parking Brakes Compatible With Lever Extension WLV1

	Product Number	MSRP
Right	WLLEVR	46.95
Left	WLLEVL	46.95
Kit	WLLEVKIT	99.95

Kit: Left & Right Brake, Two 1" Clamps Included.



Lever Extension For Parking Brakes, 18x8mm, Length 60mm

	Product Number	MSRP
	WLV1	14.95

Compatible ONLY With WLLEVR And WLLEVL



Brake Clamp, silver anodized

SIZE	Product Number	MSRP
1"	WLAL4025	19.95

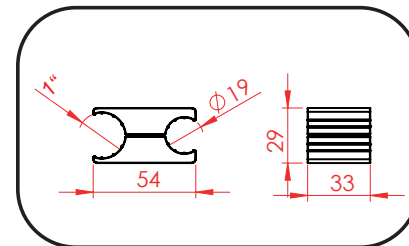

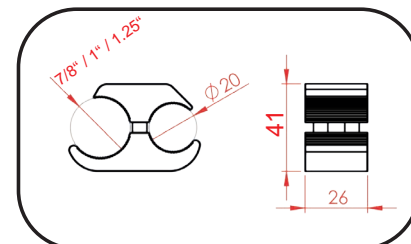

Brake Clamps, black

SIZE	Product Number	MSRP
7/8"	WL22LP	19.95
1"	WL25LP	19.95
1.25"	WL30LP	19.95



Pride & Quantum



Composite Hub With Poly Tire, Specially Designed Bearing Spacer Makes Installation Quick And Easy, No Washers Necessary.

Size			Product Number	MSRP
5x1.75"	Black	Black	PC1745BB	79.95
5x1.75"	Black	Grey	PC1745BG	79.95
5x1.75"	Silver	Black	PC1745SB	79.95
5x1.75"	Silver	Grey	PC0381SG	79.95



Invacare, Pride, Quantum, Sunrise

Split Hub With Poly Tire



Size			REF	Product Number	MSRP
6x2"	Black	Black	Invacare 7/16"	PC2604BB	69.95
6x2"	Black	Grey	Invacare 7/16"	PC5036BG	69.95
6x2"	Silver	Black	Pride/Quantum/Sunrise	PC2047SB	69.95



Pride & Quantum

Composite Hub With Poly Tire

Rolko Design



Size			Product Number	MSRP
6x2"	Black	Black	PC0039BB	79.95
6x2"	Black	Grey	PC1762BG	49.95
6x2"	Silver	Black	PC0011SB	69.95



Pride & Quantum

Composite Hub With Poly Tire



OEM Design

Size			Product Number	MSRP
6x2"	Black	Black	PC0039BB1	81.95
6x2"	Black	Grey	PC2130BG1	67.95
6x2"	Black	Dark Grey	PC0040DG1	92.70
6x2"	Silver	Black	PC2131SB1	49.95



Permobil

Wheel Hardware And Plugs/Caps Included

			REF	Product Number	MSRP
180mm	68mm	Black	Permobil 1832937 for the M3	PC725BB	79.95
210mm	65mm	Black	Permobil 1830780 for the F3, F5, M5	PC720BB	79.95



Rovi



Aluminum Split Hub With Poly Tire For Mono Fork, Axle Cap Included

Size			Product Number	MSRP
6x2"	Black	Black	PCROVIBB	89.95
6x2"	Black	Grey	PCROVIBG	89.95



Invacare



Split Hub With Poly Tire

Size			REF	Product Number	MSRP
8x2"	Black	Black	Invacare 7/16"	PC0811BB	59.95
8x2"	Black	Grey	Invacare 7/16"	PC0811BG	59.95



Invacare

Split Hub With Poly Tire, Specially Designed Bearing Spacer Makes Installation Quick And Easy. No Washers Necessary.

Size			REF	Product Number	MSRP
8x2.2"	Black	Black	Invacare 7/16"	PC1108BB	69.95
8x2.2"	Black	Grey	Invacare 7/16"	PC1108BG	69.95



Technician Notes

Rolko foam filled wheels are puncture proof.
All black tires are non-marking (NM).



Pride & Quantum

Drive Wheels With Foam Filled Tires, Compatible with
Pride & Quantum: Jazzy 600 ES, Aspen, Lightning,
Q4, Q6 Edge 3, Stretto, Edge Z, Edge HD 4 Front 2



Size	RIM COLOR	TIRE COLOR	Product Number	MSRP
14x3"	Black	Black	PWPQ14BB	229.95
14x3"	Black	Grey	PWPQ14BG	229.95
14x3"	Silver	Black	PWPQ14SB	259.95
14x3"	Silver	Grey	PWPQ14SG	259.95



Permobil

Drive Wheels With Foam Filled Tires, Compatible with
Permobil: C300, 350, 400, 500, 500S, K300, M300, 400



Size	RIM COLOR	TIRE COLOR	Product Number	MSRP
14x3"	Silver	Black	PWPM14SB	219.95
14x3"	Silver	Grey	PWPB14SG	219.95



Pride

Drive Wheels With Foam Filled Tires, Compatible
With Pride PN WHLASMB1418

		TIRE COLOR	Product Number	MSRP
260mm	85mm	Grey	PW26085G	199.95

Power Chair Tires

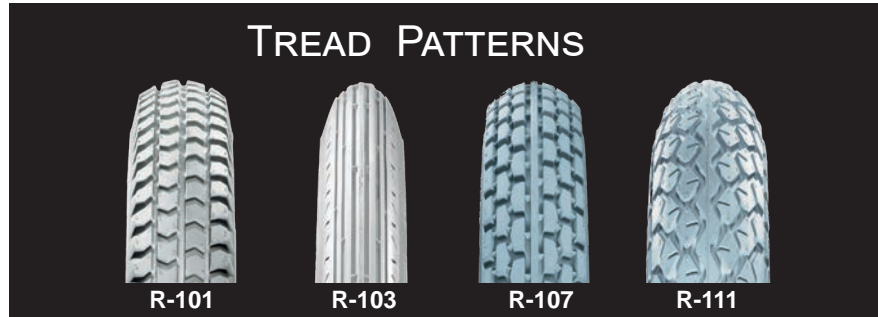

RolkoFill: Foam Filled Tires, All Black Tires Are Non-Marking (NM)

Size	TIRE COLOR			MPH	REF	Product Number	MSRP
8x2"	●	R-103	28	110	7.45	-	AA20050G 59.95
8x2"	●	R-103	28	110	7.45	-	AA20050B 59.95
2.80/2.50-4"	●	R-103	55	145	7.45	-	AA28254G 99.95
3.00-4"	●	R-101	55	200	7.45	-	AA2685G 129.95
3.00-4"	●	R-101	55	200	7.45	-	AA2685B 129.95
12.1/2x2.1/4"	●	R-107	46	132	7.45	-	AA125225G 119.95
3.00-8"	●	R-101	38	200	7.45	Permobil/Invacare	AA3008NG 169.95
3.00-8"	●	R-101	55	200	7.45	Sunrise	AA3008WG 169.95
3.00-8"	●	R-101	38	200	7.45	Permobil/Invacare	AA3008NB 169.95
3.00-8"	●	R-101	55	200	7.45	Sunrise	AA3008WB 169.95
3.00-8"	●	R-101	55	200	7.45	Pride/Quantum	AA3008ZG 179.95
3.00-8"	●	R-101	60	200	7.45	Pride/Quantum	AA3008ZDG 179.95
3.00-8"	●	R-101	55	200	7.45	Pride/Quantum	AA3008ZB 179.95
4.00-5"	●	R-111	65	200	7.45	-	AA4005G 239.95



RolkoFILL

Pneumatic Tires, All Tires Are Puncture-Proof (PP), Black Tires Are Non-Marking (NM)

Size	TIRE COLOR			Product Number	MSRP
8x2"	●	R-103	132	PD20050G	18.95
8x2"	●	R-103	132	PD20050B	19.95
2.80/2.50-4"	●	R-103	265	PD280250G	28.95
2.80/2.50-4"	●	R-103	265	PD280250B	29.95
3.00-4"	●	R-101	375	PD26085G	35.95
3.00-4"	●	R-101	375	PD26085B	38.95
3.00-8"	●	R-101	395	PD3008G	56.95
3.00-8"	●	R-101	395	PD3008B	61.95
3.00-8"	●	R-101	395	PD3008DG	61.95

Depending on the floor material and color as well as braking effect, black pneumatic tires may rarely leave marks in the flooring. Note the instructions for use from the flooring manufacturer.

2-Point, Metal Buckle For Manual Chairs

L	W	GROMMET	Product Number	MSRP
48"	2"	7/16"	SB548M	47.95
60"	2"	7/16"	SB560M	47.95
72"	2"	7/16"	SB572M	49.95

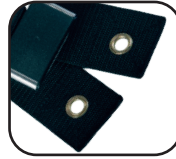

Belt Fixation

2-Point, Light Metal Buckle

L	W	GROMMET	Product Number	MSRP
63"	1.6"	7/16"	SB463M	49.95



Belt Fixation

2-Point, Metal Buckle For Power Chairs

L	W	GROMMET	Product Number	MSRP
48"	2"	5/8"	SB548P	52.95
60"	2"	5/8"	SB560P	52.95
82"	2"	5/8"	SB582P	55.95



Belt Fixation

2-Point, Light Metal Buckle

L	W	Product Number	MSRP
70"	2"	SB570K	49.95
88"	2"	SB588K	58.95



Belt Fixation



2-Point, Light Metal Buckle, Belt Ends With Triglides

L	W	Product Number	MSRP
70"	2"	SB570K4	58.95



Auto Standard Buckle Without Fixation/Grommet

L	W	Product Number	MSRP
70"	1.6"	SB470J	45.95
70"	2"	SB572J	45.95

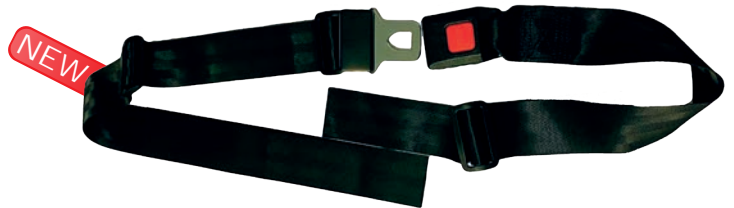

Aircraft Seatbelt

L	W	GROMMET	Product Number	MSRP
36"	2"	7/16"	SB536FS	59.95
48"	2"	7/16"	SB548FS	59.95
60"	2"	7/16"	SB559FS	59.95



Flat Iron On The Tongue Side



Knurled Bar On The Lock

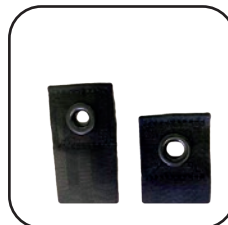

Belt Fixations

2-Point, Snap Buckle Made of Plastic

L	W	Product Number	MSRP
62"	1.6"	SB4P62K	29.95



Belt Fixation



2-Point, Light Metal Buckle

L	W	Product Number	MSRP
70"	1.6"	SB470K	49.95



Belt Fixation



2-Point, Light Metal Buckle, With Pin Lock

L	W	Product Number	MSRP
70"	2"	SBPL70K	79.95



Belt Fixation



4-Point Belt Without Fixation To The Belt Ends Diagonal Belts 1" And Hip Cushion 7.5x2"

L	W	Product Number	MSRP
55"	2"	SB3554P	99.95



4-Point Belt, Metal Eyelet Fixation Belt Ends Diagonal Belts 1" And Hip Cushion 9x2.8"

L	W	Product Number	MSRP
67"	1.6"	SB4674P	119.95



Tube Clamps

Product Number	MSRP
RH2225	24.95

Technician Notes

Tube clamps for attaching snap locks to round tube, includes spacers for 19, 22 + 25 mm. Price per each set. One set required for each side of chair.



Positioning

Arm Supports

Soft Synthetic Leather Cover, Light Plastic
Lower Part With 6 Threaded Sockets M5

L	W	H	Product Number	MSRP
10.5"	2.37"	1.5"	AG240HD	24.95
14.6"	2.37"	1.5"	AG370HD	25.95

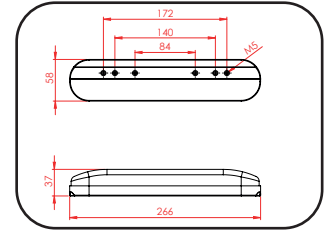

PU Foam, Wood Core

L	W	Product Number	MSRP
15"	9"	AGPU375	39.95

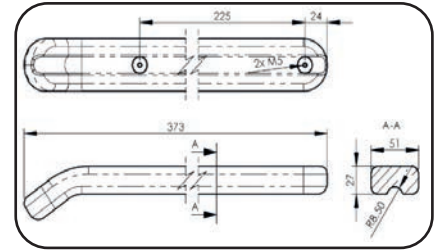

Permobil

PU Foam, Aluminum Core, Cable
Fixation Kit Included

L	W	Product Number	MSRP
13"	3.5"	AGPU335S	79.95
16"	3.5"	AGPU406S	79.95

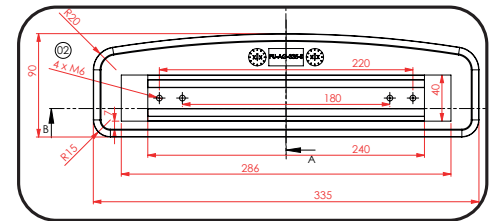

AGPU335S

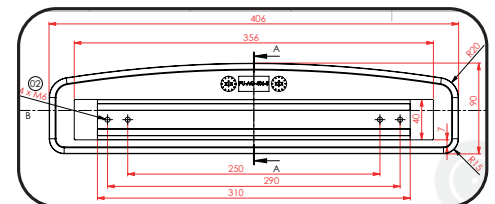

AGPU406S

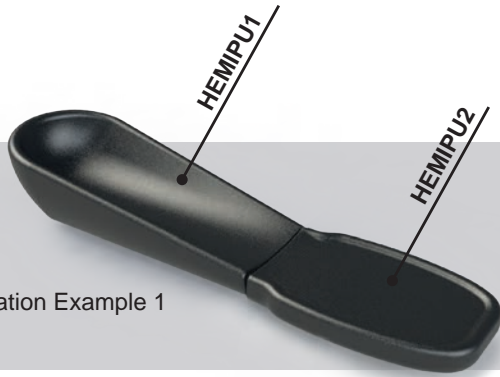

Combination Example 1

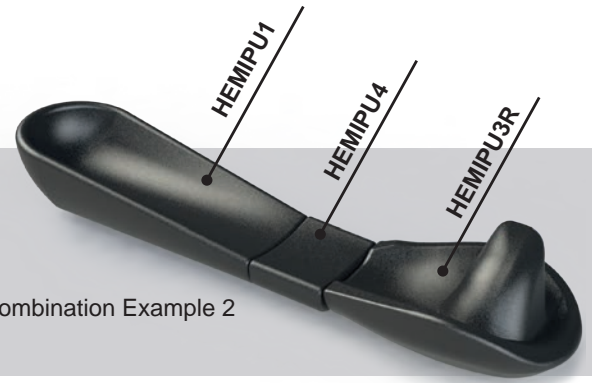

Combination Example 2

Premium High Density, Closed Cell Polyurethane

Support With Slot Nuts For An Optimal Forearm Stabilization And Positioning.

Product Number	MSRP
HEMIPU1	119.95

Universal Comfort Hand Rest. Includes Connecting Plate With 4 Set Screws.

Product Number	MSRP
HEMIPU5	119.95

Arm Rest. Includes Connecting Plate With 4 Set Screws.

Product Number	MSRP
HEMIPU2	65.95

Comfort Hand Rest. Includes Connecting Plate With 4 Set Screws.

	Product Number	MSRP
Left	HEMIPU3L	119.95
Right	HEMIPU3R	119.95

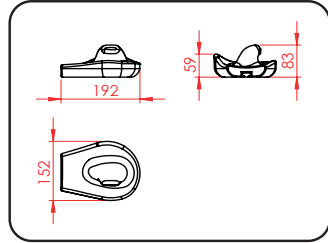
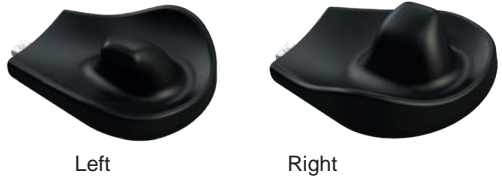
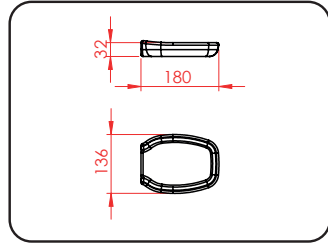
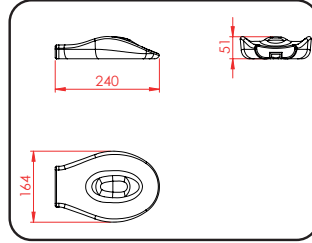
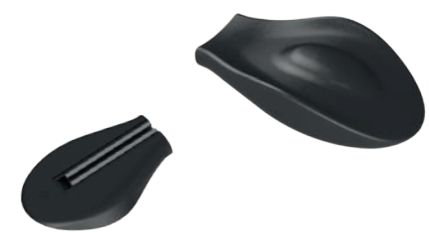
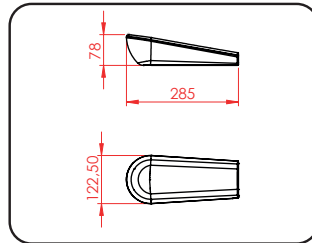

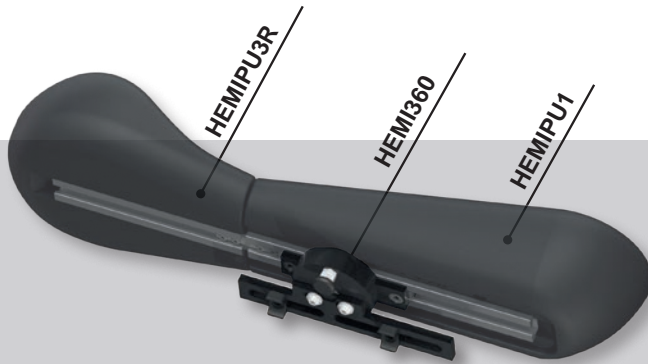

Premium High Density, Closed Cell Polyurethane

Extension Piece. Includes Connecting Plates With 4 Set Screws.

Product Number	MSRP
HEMIPU4	65.95

Technician Notes

Low profile fixation unit, 60° turnable swivel arm, with round tube adapter for attachment on wheelchair side parts, mountable on the left or right side, includes 2 slot nuts, outreach 17.5mm, hole distance 141mm.

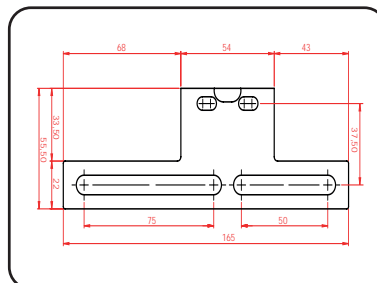
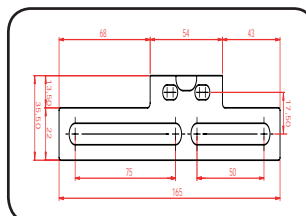
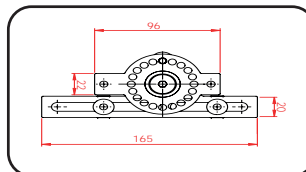
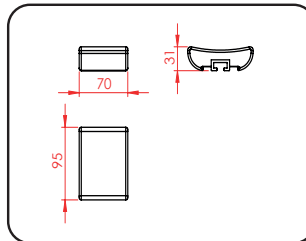

360° Fixation Unit

Product Number	MSRP
HEMI360	199.95

Additional Support Plate, Outreach 37.5mm, Hole Distance 141mm

Product Number	MSRP
HEMIRBP	45.95

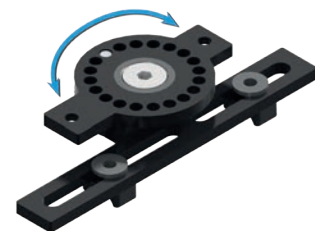

Upper side

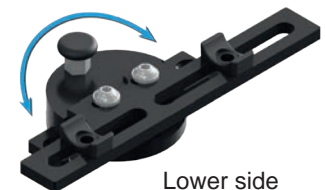

Lower side



Hook And Loop Straps For Foot Rests, Includes: 4 Straps only, Foot Plate Not Included.

L	W	Product Number	MSRP
28"	1.5"	FGFS700	29.95



Foot Rest With Slots And Thread-Holes, Set With 2 Piece Foot Plate, Straps Are Not Included.

L	B	B1	Product Number	MSRP
7"	2.7"	8"	FSK180	59.95
8.22"	3"	8 2/3"	FSK215	59.95
9.3"	3.5"	9 1/6"	FSK240	69.95
11.3"	4.3"	11"	FSK280	89.95
13"	5"	12 2/3"	FSK320	99.95

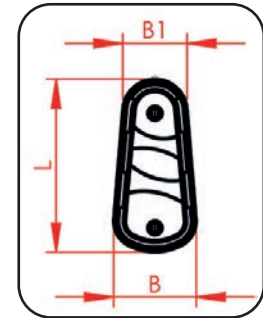

Foot Straps: FG250KB: 2-Piece, Each With One Loop (Ø 13mm) And One Hook And Loop Tape. FG450KB: 1-Piece With One Loop And One Hook And Loop Tape, Color: Black. Foot Plate And Assembly Not Included.

L	W	Product Number	MSRP
9.5"-17"	2"	FG250K	24.95
18"	2"	FG450KB	24.95

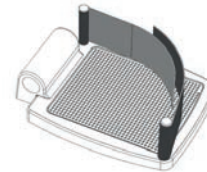

FG250KB

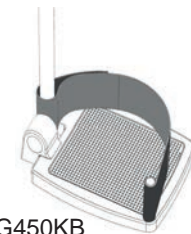

FG450KB

Foot Board For Tube Diameter 1"

L	W	Product Number	MSRP
6.8"	5.5"	FBK173S	9.95



Foot Belt With Fixation, 1 Pair

Size	Product Number	MSRP
Medium	FGM	119.95
Large	FGL	119.95



Calf Strap With Hook And Loop Tape

	L	W	Product Number	MSRP
Standard	27.5"	2"	WG700K	29.95
Standard	32"	2"	WG820K	29.95
Smooth	33.5"	3"	WG850SK	36.95



Smooth



Standard

Abductor Wedges And Restraining System

Restraining System For Abductor Wedges, Height And Depth Adjustable, Steel Mounting Plate With 8 Holes, Bore 1/5", For Fixation Below The Wheelchair Seat Area.

L	Product Number	MSRP
3.1"	AKHA1	99.95
6.3"	AKHA2	99.95



Abductor Wedges In Polyurethane Foam With Wood Core

	L	W	H	Product Number	MSRP
Small	3.6"	2.6"	3.5"	AKPUS	79.95
Medium	4.4"	3.2"	3.9"	AKPUM	79.95
Large	5"	3.6"	3.9"	AKPUL	79.95

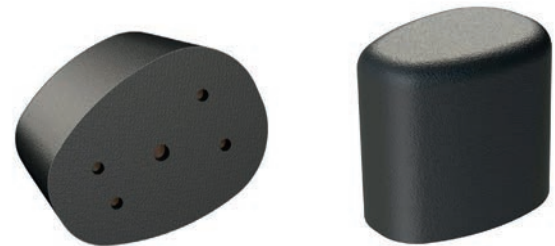

Restraining system for head supports, in aluminum with gooseneck for back rest attachment. Up to 13.8" height adjustable. Mounting plate and ball head Ø 1" with clamp included.

Product Number	MSRP
HRHAALR	119.95

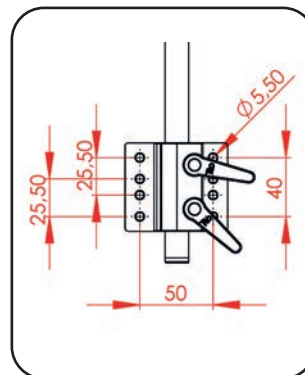

Mounting Plate Measurements In mm





Aluminum Core, Back Side: For 25mm Ball Head Mount. 96x225x100mm

Product Number	MSRP
HRPU5	59.95

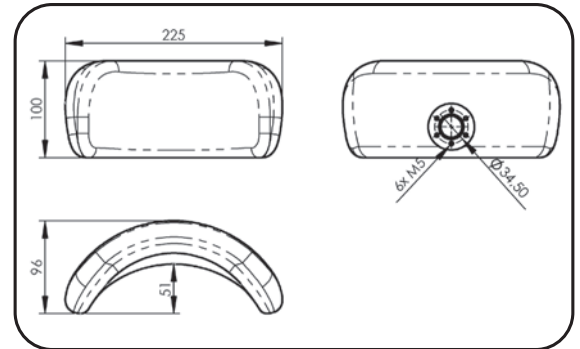

Aluminum Core, Back Side: For 25mm Ball Head Mount. 110.5x300x150mm

Product Number	MSRP
HRPU7	119.95

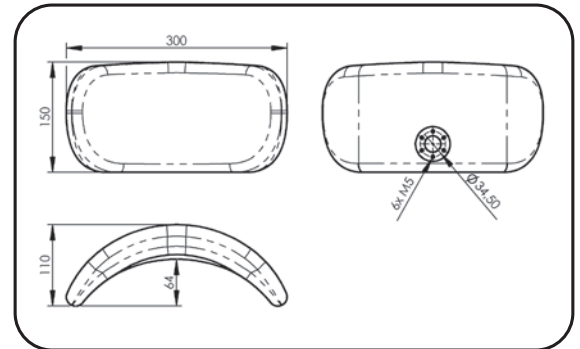

Positioning

Hand Grips

Soft Foam Rubber Hand Grip,
Sold in Pairs

Ø	L	Product Number	MSRP
7/8"	4.33"	GR120	12.95



Ergonomic Hand Grip With Soft Grip
Surface, Sold in Pairs

Ø	L	Product Number	MSRP
7/8"	4.33"	GRERG	24.95



Standard Composite Hand Grip,
Sold in Pairs

Ø	L	Product Number	MSRP
7/8"	4.33"	GRKS	9.95



Ergonomic Composite Hand Grip,
Sold In Pairs

Ø	L	Product Number	MSRP
7/8"	4.33"	GRS	19.95



Comfort Composite Hand Grip,
Sold in Pairs

Ø	L	Product Number	MSRP
7/8"	4.72"	GRER22	19.95
1"	4.72"	GRER25	16.95



Tube Cover, Smooth

Ø	L	Product Number	MSRP
7/8"	8"	GR210G	9.95
7/8"	10"	GR260G	11.95
7/8"	27"	GR680G	19.95



Additional comfort for wheelchair companions, quick-release levers for an easy usage and fixation on a wheelchair, height adjustable without tools, incl. mounting kit for tube Ø 7/8" or 1".

Pipe Ø	H	Product Number	MSRP
7/8"/1"	9"	SGE2	179.95
7/8"/1"	8"	SGE3	239.95

*Max. height adjustment

Easy Push

Push Handle Elevations



Model: SGE2



Model: SGE3



Additional Mounting Kit With
1 Quick-Release Lever, 2
Screws M6 And 1 Tube Clamp.

Product Number	MSRP
USEG2	39.95



Rolko EasyTRANSFER Transfer Boards

Facilitates The Transfer Of Persons From Wheelchair To Bed Or Car, Independent Usage Without External Help, Can Be Combined With Our Transfer Disc.

W	L	H			Product Number	MSRP
9"	28"	0.5"	360 lbs	287 lbs	RBK700	109.95
8"	27"	0.4"	275 lbs	287 lbs	RBKKV	179.95



Standard
RBK-700





Curved
RBK-KV



Rolko EasyTRANSFER Transfer Disc

Allows A Convenient Transfer Of Persons From The Wheelchair To The Bed Or Into Another Sitting Position, Independent Usage Without External Help, Can Be Combined With Our Transfer Boards.

	H			Product Number	MSRP
16"	1.5"	37 lbs	287 lbs	DRT400	229.95



Anti-Tip Wheel

Anti-Tip Wheel With Adapter For Tube Diameter 22 + 25 mm, One Horizontal And One Vertical Bore

	Product Number	MSRP
22+25	KSH2225	29.95

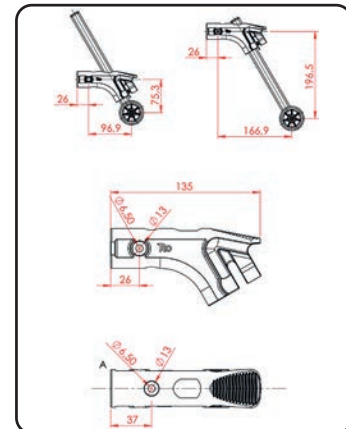

Umbrellas

Rolko Umbrellas Offer Optimal Protection Against Rain and Sun, While Leaving Both Hands Free To Push the Walker. Wheelchair Compatible. Height Adjustable, User-Friendly Automatic Opening, Windproof Due To Overlapping Fabric Construction, Easy To Attach/Remove From Walker or Chair. Includes Mounting Kit For Common Walkers With Round Tube Ø 18-25mm (0.71"-1") or Oval Tube up to 60mm (2.36"), Umbrella Diameter: 1.000mm (39.37").



Additional colors

C	Product Number	MSRP
●	UMR	159.95
●	UMGG	159.95
●	UMBG	159.95

Additional Mounting Kit

For a Second Medical Aid, Wheelchair, or Scooter, Includes: 90° Angle Support With Clamps (Ø 18 - 25mm), Wedge Clamps, Screws, Allen Wrench and Star Grip.

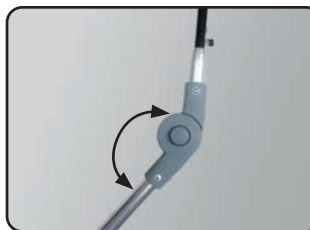

Articulated Joints For Multiple Positions.

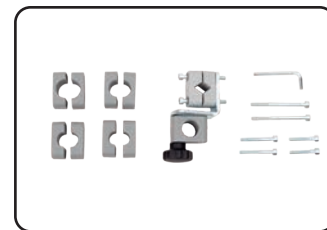

Hardware Included.

Mounting Kit

Product Number	MSRP
UMU90	59.95



Technician Notes

Includes Fixation For Round Tube Ø 18-25mm, Oval Tube Up to 60mm

Stable and Padded, For Common Walkers With Round Tube 22mm, Easy Assembly With Tube Clamps.

	L	W	Product Number	MSRP
7/8"	22.65" up to 25.2"	2.56"	RGROL01	69.95



Rolko BAG

Wheelchair Bag

Practical Belt System For Easy Attachment To Manual And Electric Wheelchairs. Comfortable Grip Loops On The Zippers, Holding System For Bottles And Openings For Cable. Waterproof And Dirt Resistant.

W	H	D	Product Number	MSRP
14"	18.5"	6"	BAG01G	139.95



Docking Station For Straps



Side Pocket With Cable Eyelet



Main Bag With Straps For Bottles



WHEELBAG

Transport Bag for Spoke Wheels

Three Separated Compartments For Spoke Wheels 20" Up To 26", E.g. For A Wheel Set And A Spare Wheel, Incl. Hub Pads, Carrying Handles, Shoulder Strap And Inner Pocket For Accessories Such As Quick-Release Axles.

W	D	Product Number	MSRP
27"	8"	BAGWH1B	139.95



Inner pocket for accessories



3 separated compartments



2 hub pads per compartment



Rolko Thermo Wrap-up Blankets

With a water-repellant outer material and a quilted, lint-free polar fleece lining, the wrap-up blanket rolko-thermo is the perfect companion in autumn and winter ensuring that you stay dry and comfortably warm. Easy to use due to hook and loop fasteners.



Size	L	W	Product Number	MSRP
L	5 ft	4 ft	WBL	99.95
XXL	6 ft	4 ft	WBXXL	116.95



Water-repellent material



Warm polar fleece, quilt lining



With hook & loop straps

Rolko rainPRO Scooter Cover For Mobility Scooters

Consisting of a water, uv and frost resistant material, our scooter garage rolko-rainpro offers protection against weather and dust, with reflective strips marking the longitudinal direction and thus simplifying handling, including weight strap and loops.



Size	L	W	Product Number	MSRP
XL	5 ft	2 ft	WRGXL	99.95
XXL	6 ft	2 ft	WRGXXL	99.95

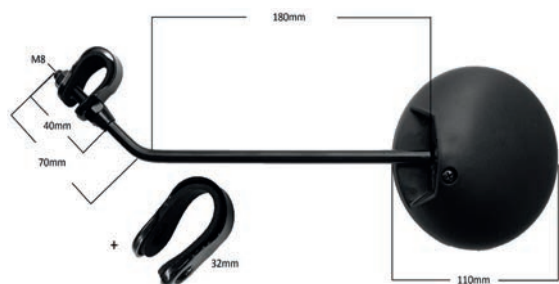

Scooter Rear Mirror

With Clamp and Hexagon Bolt M8 For Fixation, Universal Fit, Sold In Pairs.

Product Number	MSRP
USMX2	24.95

Rolko Thermo Body Warmers

Our body warmers are made from a water-repellant outer material, being perfect for cold and rainy weather. The non-lint polar fleece liner provides a pleasant warmth and comfort. Easy to use due to circumferential zipper with large handle loops.



Size	Body Size	Product Number	MSRP
S	up to 1600mm/63"	WWS	149.95
M	up to 1700mm/67"	WWM	159.95
L	up to 1800mm/71"	WWL	159.95
XXL	up to 1950mm/77"	WWXXL	179.95



Front pocket with reflective stripe



Fixation loops for push handles



Non-slip bottom

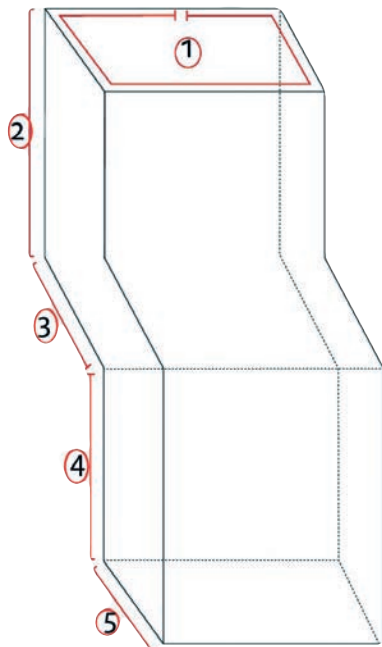

	Adults							
	S WW-S	Approx.	M WW-M	Approx.	L WW-L	Approx.	XXL WW-XXL	Approx.
1	1300	51"	1420	56"	1590	63"	1850	73"
2	410	16.1"	440	17"	470	19"	500	20"
3	430	17"	460	18"	490	19.2"	510	20"
4	400	16"	425	17"	470	19"	500	20"
5	300	12"	315	12.4"	320	13"	350	14"

	Children			
	XXS WW-KID-1	Approx.	XS WW-KID-2	Approx.
1	850	33.4"	1050	41"
2	260	10.2"	300	12"
3	280	11"	340	13.3"
4	270	11"	380	15"
5	180	7"	220	9"

Rolko Thermo

Body Warmer For Children



Our children body warmers are made from a non-lint polar fleece liner and a water-repellant outer material, being optimal for cold and rainy weather. Suitable for belt systems of common wheelchairs and strollers: simply cut into the stitched strips. Circumferential zipper with handle loops. Back strap for the attachment on the wheelchair/stroller. Washable up to 86°F.

Size	Age	Body Size	Product Number	MSRP
XXS	1-3 years	31"-35"	WWKID1	179.95
XS	4-8 years	39"-50"	WWKID2	179.95



With reflective stripes

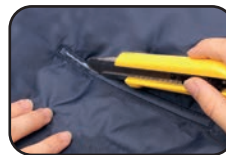

Suitable for common belt systems



Non-slip bottom

Rolko Thermo

Thermo Leg Protection

Due to the water-repellent outer material, our leg protection offers an optimal protection during wet and cold conditions. Straps with push buttons allow easy installation to the wheelchair. Washable up to 86°F.

Size	Body Size	Product Number	MSRP
L	45"	WWAL	81.95



Easy fixation on wheelchair



Reflective stripe for more safety



Polar fleece inner lining



Headquarters

Germany

Rolko Kohlgrüber GmbH
Industriestraße 14 - 16
D-33829 Borgholzhausen
Phone +49 (0) 5425 9402-0
info@rolko.com



United States

Subsidiary

Rolko North America Inc.
398 W. 230th Street
Bloomfield, IA 52537
Phone +1 641 351 6400
info@rolkona.com



For More Information,
Catalog Download
& Webstore

Subsidiary

Denmark

Rolko Scandinavia ApS
Suensonsvej 2
DK-8600 Silkeborg
Phone +45 (0) 87 20 18 88
rolkodk@rolko.com

Subsidiary

Netherlands

Rolko Nederland bv
Pakketboot 51
NL-3991 CH Houten
Phone +31 (0) 302 567 890
rolkonl@rolko.com

Production

China

**Rolko (Zhangzhou) Wheels
& Components Co. Ltd.**
363999 Changtai, Zhangzhou