

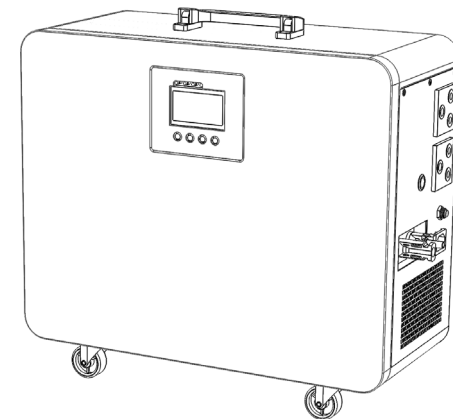

KOOL ENERGY
Powering you on

User Manual



UPS&Solar Inverter Power System

8 Technical specification sheet

Model		KL-1000W
Battery rated voltage		25.6VDC
Inverter	Rated power	1000W
	Input voltage range	145-275VAC
	Input frequency	45-65Hz
	Output voltage	230VAC
	Output frequency	50/60Hz
	Output wave	Pure Sine Wave
	Specification of built-in battery	1*50AH/25.6V
MPPT Solar input	MPPT Voltage Range	35V~100VDC
	PV Power	840W(Max)
	Rated charge current	30A(Max)
	MPPT efficiency	≥97%
	Floating charge voltage	28.4VDC
DC output	High voltage protection(no output)	32.0VDC
	High voltage recovery (with output)	30.4VDC
	Low voltage recovery (with output)	26.8VDC
	Low voltage protection (no output)	22.4VDC
	5VDC USB output	2 units /MAX 2A
	12VDC output ports	2 units /MAX 2A
Heat dissipation/Cooling		Temperature control by intelligent exhaust fan
Operating ambient temperature		-20 - +50℃
Storage ambient temperature		-25 - +55℃
Operating/Storage ambient		0-90% No condensation
External size: W*D*H (mm)		480*192*410
Package size: W*D*H (mm)		527*277*475
Net Weight (kg)		29
Gross Weight (kg)		31

Note: Our company has the right of changing this user manual without any information

Dear Customers:

Thank you very much for choosing our products! Before using this product, please read this manual carefully, including installation, use, troubleshooting and other important information and advice. Please properly keep this manual!

Catalogue

1、Product Features.....	1
2、Installation and storage instructions	1
3、Product appearance diagram and introductions.....	2
4、Device connection icon	12
5、Power ON/RUN	14
6、Product maintenance	17
7、Simple fault judgment and processing	18
8、Technical specification sheet	19

1 Product features

- ◆ Pure sine wave output;
- ◆ 2000 cycles LifePO4 battery and has a 5 years service life;
- ◆ The mains input automatically turns on and activate the LifePO4 battery
- ◆ PV input activate the LifePO4 battery
- ◆ The mains supply mode/battery mode can be set for flexible;
- ◆ Convenient and practical 5VDC-USB2.0;and 12VDC output port;
- ◆ MPPT Controller greatly improving the charging efficiency more than 20%;
- ◆ Overcharge protection and over discharge protection for a longer battery life;
- ◆ Safe and reliable with intelligent exhaust fan control;
- ◆ Overload automatic protection and alarms including AC output overload protection, short circuit protection. Etc;

2 Installation and storage instructions

2.1 Off package inspection

2.1.1 open the packaging of the equipment, please check the product parts, including: a mainframe, the use of a manual.AC cable one unit.

2.1.2 check whether the equipment is damaged in transit, such as damage or missing parts, do not boot, inform the carrier and dealer.

2.2 Installation and storage attention.

2.2.1 Installation equipment should be operated by professionals, or assisted by local distributors.

2.2.2 Transport equipment, the need to take appropriate protective measures; equipment from low temperature to high temperature environment, may appear drops, before using, need to be completely dry, to ensure safety.

2.2.3 Don't expose the device in the wet, inflammable, explosive or a lot of dust accumulation in the bad environment; do not cover and block the vents, 10cm above the air circulation space reserved for peripheral equipment; in order to have good heat dissipation;

2.2.4 When the equipment is not in use,it should close all switches;

7 Simple fault judgment and processing

WARNING: There's high voltage inside! It may cause electric shock hazard or death! Do not open the cover unless you are the qualified technician.

The fault phenomenon	Possible reason	Solutions
Utility power disconnect	Reset fuse disconnect due to over current	Reduce the load and reset the reset
Machine load time reduced	Undercharged battery	Make sure that the battery is properly charged before using the device
	Over load	Reduced load power
	The battery ages and the battery capacity decreases	Please contact your customer service representative to purchase a new battery
Equipment can not be turned on	Battery under voltage or internal circuit fault	Contact local distributors
Turn on alarm	Refer to the error code table	Refer to the error code table
Fan rotation sometimes fast and sometimes slow	Fan according to temperature regulation	Normal phenomenon
When sunlight is shining directly into the PV panel, the "Solar" indicator is off	PV input disconnect	Check whether the cables at both ends of the photovoltaic panel are connected correctly and whether the contact is reliable

When you contact the service personnel, please provide the following information: Type of machine / date of issue / complete description of the problem (including the relevant indicator display status, battery configuration, connection and other information).

6 Product Maintenance

6.1 This series of products with little maintenance, battery only need to constantly maintain the charge to obtain life expectancy. In the same city electricity connection.

6.2 If you do not use the equipment for a long period of time, it is recommended to charge it every 4-6 months. Under normal circumstances, the battery's life will be 3-5 years, if found in poor condition, you must replace the battery early. When replacing the battery, it must be carried out by qualified personnel. Battery should not be individually replaced, the overall replacement should follow the battery supplier's instructions.

6.3 Normal use, the battery every 4 to 6 months to be charged, discharge time, discharge to the shutdown charge, In the high temperature region, the battery charge every two months, discharge time.

6.4 Before replacing the battery, turn off the device and disconnect it from the mains, and close the battery switch. Take off metal objects such as rings and watches. Use insulated handle and screwdriver, do not put tools or other metal objects on the battery pack.

6.5 When connecting the battery cable, it is normal for small sparks to appear in the joint, which will not cause any harm to the personal safety and the equipment. Do not charge the battery positive and negative, very short or reverse connection.

3 Inverter diagram, operation instructions

3.1 Front panel icon

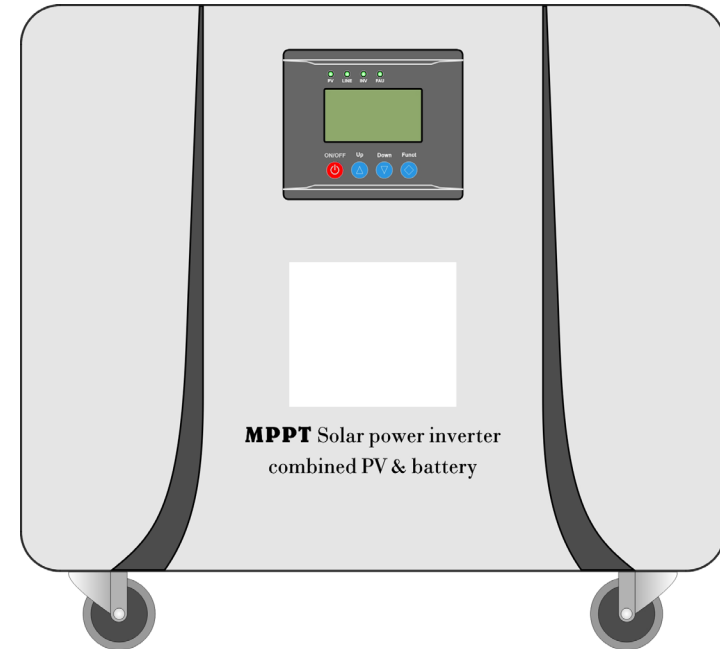

3.2 Back panel icon

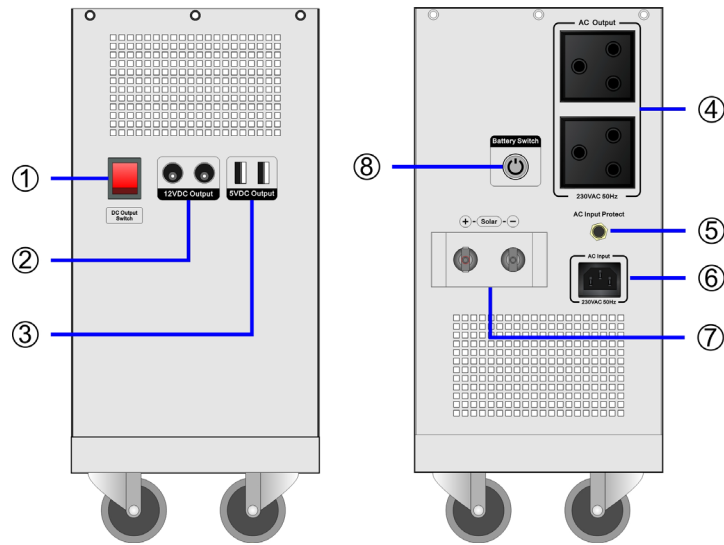

Guide

- ①-- 5VDC-USB、12VDCoutput ON/OFF switch
- ②-- 12VDC Output: 12VDC-USB Output terminal
- ③-- 5VDC Output: 5VDC Output terminal
- ④-- AC Output(MAX 10A)
- ⑤-- AC input fuse holder
- ⑥-- AC Input
- ⑦-- Solar input terminal
- ⑧-- Battery input switch

5.5 Audible alarm reminder instruction

Equipment running normal	Buzzing prohibit	Buzzer is no tweet under default state
	Buzzer starts	Buzzer tweet 4 times every 15s, indicate the equipment operated under battery inverter state
Battery high voltage alarm	Buzzer tweets 4 times per second, alarms high voltage	
Battery low voltage alarm	Buzzer tweets 2 times per second, alarms low voltage	
Over temperature alarm	Buzzer alarm 2 seconds pause 1 second	

5.6 Electric generator connection announcements

If connect electric generator, it needs operating as below

5.6.1 Start up electric generator and after it running stable, make electric generator output power supply be connected into the equipment input terminal, then make sure the equipment output is no-load, then start up the equipment.

5.6.2 After the equipment starting, then connect load one by one

5.6.3 We suggest electric generator capacity should be 2~3 times of this equipment.

5.7 Others:

During product transportation and storage, the battery needs to be recharged once every 3-4 months to maintain battery activity.

5.3 Equipment shutdown

Shutdown: Turn off the loads, disconnect AC input, and then press the "power on / off button" for 2 seconds, release after the internal relay action, the device off the AC output and LCD screen is turned off. Switch off all the circuit breakers.

OPERATION PRECAUTIONS: Please follow the following steps to turn on the inverter. First switch on the battery circuit breaker, and then switch on the solar input circuit breaker. To turn off the inverter, switch off the solar input breaker, then switch off the battery circuit breaker;

Caution: If the inverter is idle for long time, please turn off the battery breaker to avoid the battery deep discharging. Unless the solar power or AC input is connected to maintain the battery at safety level.

5.4 Battery protection voltage of the inverter Introduction / Parameter table

When the AC output is turned on, the relevant protection or indication will be executed when the battery voltage reaches the value in the table below.

Inverter battery protection voltage parameter table-25.6V;			
Over voltage protection	Over voltage recovery	Low voltage alarm	Low voltage protection
33.6	32.0	23.0	22.4
Shut down the AC output	With AC output	With AC output	Mains input and charge battery

3.3 Front panel instructions

3.3.1 LCD display and function key operation interface, can display the working status of the equipment, such as: Input / output voltage, frequency, mains mode, the inverter mode, battery capacity, charge current, charge the total load capacity, warning tips.

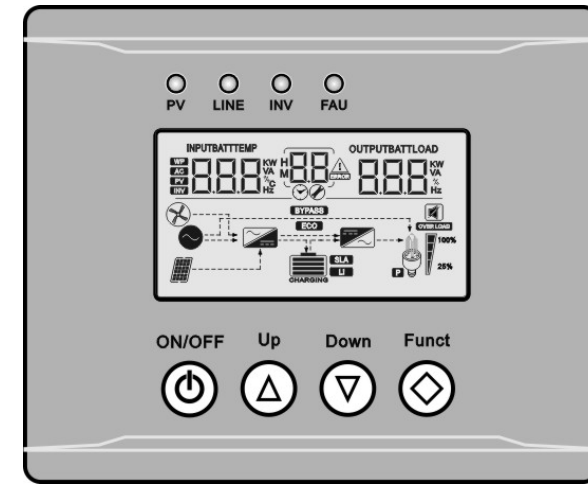

3.3.2 Keys Description

Function keys	Description
	Power on / off key Single on / off control
	Page up/set key Under the main interface, click to view the device parameters and set the increment under the interface
	Scroll down/set key Under the main interface, click to view the device parameters and set the decrement under the interface
	Function keys Long press to enter device mode setting /Under the setting interface, short press the button to confirm the parameters and return to the main interface

3.3.3 LED Status Description

LED display			Description
PV	Green	Light	PV start charging
		OFF	PV stop charging
LINE	Green	Light	The AC is connected and the output is bypassed
		OFF	Do not connect AC power or it is in inversion state
INV	yellow	Light	The device is in inversion state
		OFF	The device is not in inversion state
FAU	red	Light	AC output overload or Inverter fault
		OFF	The device work normally

4.6 “②--12VDC Output”、 “③--5VDC Output” Connection introduction

4.6.1 Confirm DC load working current can't exceed the equipment rated current, the two “②—12VDC Output” DC terminal port on the front panel foreign respectively with 12 VDC, 1 amp current, two “③—5VDC Output” dc port foreign respectively provide 5 VDC, 1 amp of current;

4.6.2 When access dc load, note its polarity can't be wrong, it is strictly prohibited the dc port output wiring short circuit, so as not to damage the equipment;

5 Power ON/RUN

Note: Check it the voltage of battery pack and polarity of the solar module are connected to the equipment correctly.

5.1 Inverter Power ON/RUN

5.1.1 Battery starting

5.1.1.1 Power-on sequence: Turn on the “⑧--Battery Switch” on the rear panel and hold down the “Power-on/Power-off button” for 2 seconds. After hearing the buzzer once, release the button. The device is successfully turn on ,and connected to the home appliance in the power range.

5.1.1.2 Shutdown sequence: Turn off the load one by one, hold down the “Power on/Off button” for 2 seconds and release it. The AC output of the device is turned off and the LCD screen is off.

5.1.2 Mains Input Power-ON/OFF

5.1.2.1 Startup: Turn on the “⑧--Battery Switch” on the rear panel.

Access to the mains, the equipment automatically start output.

5.1.2.2 Shutdown: Shut down the load one by one, disconnect the mains input, and then hold down the “Power on/Off button” for 2 seconds and release it. The device turns off the AC output and the LCD screen turns off.

5.1.2.3 Output off in mains state: Turn off the load one by one, and hold down the “On/Off button” for 2 seconds before releasing. Then the device turns off the AC output, and the mains normally charges the battery.

5.2 Photovoltaic controller Charger-Disable

Turn on the “⑧--Battery Switch” , turn on the Solar circuit breaker, and the “PV” indicator light on the panel (green).

The solar energy charges the battery through the controller.

4.2 Input/Output wiring diagram

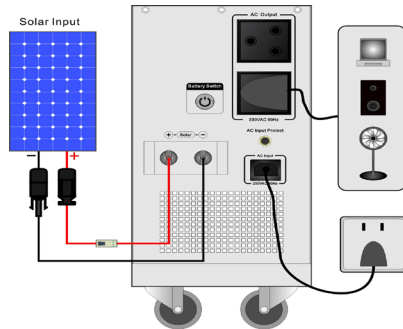

4.3 Photovoltaic module access instructions

Be sure to select the appropriate solar module according to the following specifications:

4.3.1 The open circuit voltage (Voc) of the solar module cannot be higher than the maximum open circuit voltage of the inverter.

4.3.2 The open circuit voltage (Voc) of the solar module should be higher than the minimum battery voltage of the inverter.

4.3.3 The input power of the solar panel cannot exceed the maximum input power of the inverter.

Model	1KW24VDC 30A MPPT	1500W24VDC 30AMPPT	2000W24VDC 30AMPPT
Maximum solar open circuit voltage	100VDC	100VDC	100VDC
Solar input voltage range	35-100Vdc	35-100Vdc	35-100Vdc
Maximum input power of solar energy	840Wp	840Wp	840Wp

4.4 Mains access instructions

Input mains/generator to the ⑥--AC Input block on the rear panel; LCD

The Input position displays the corresponding voltage, indicating that the listed power/generator is connected to charge the battery. Note: AC voltage input range 145V-275VAC.

4.5 Notes of output load

The load of 230VAC is connected to the "④-- AC Output" terminal. The load power is the rated power of inverter with load detection function and load percentage display.

3.3.4 LCD display instruction

3.3.4.1 View the main interface: In the main interface, press DOWN or UP to scroll through the screen.

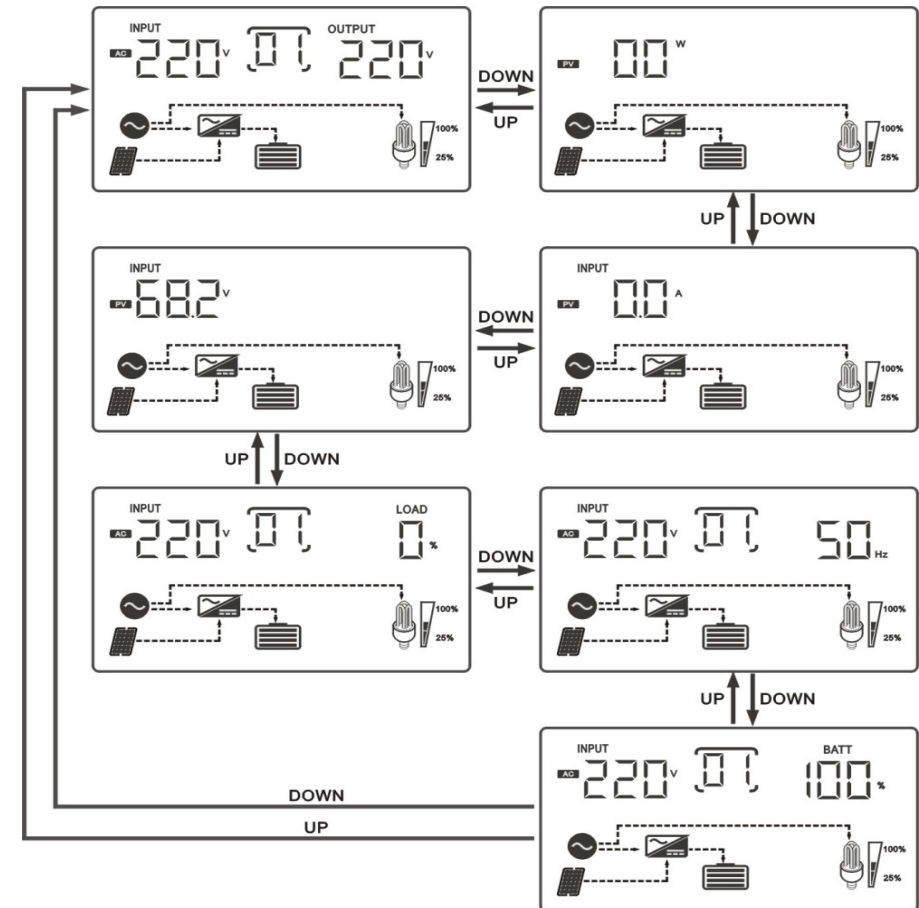

3.3.4.2 Main menu: in the main interface, long press function key for 5 seconds or less to enter the main menu, and press DOWN or UP to view the sub-menu. The function of P0/P1/P2/P3/P4 in the flashing state is as follows:

Main Menu	Functions
P4	Buzzer mode
P3	Inverter charging current
P2	N/A (This parameter is intentionally left blank)
P1	Inverter operating mode
P0	Save & Exit

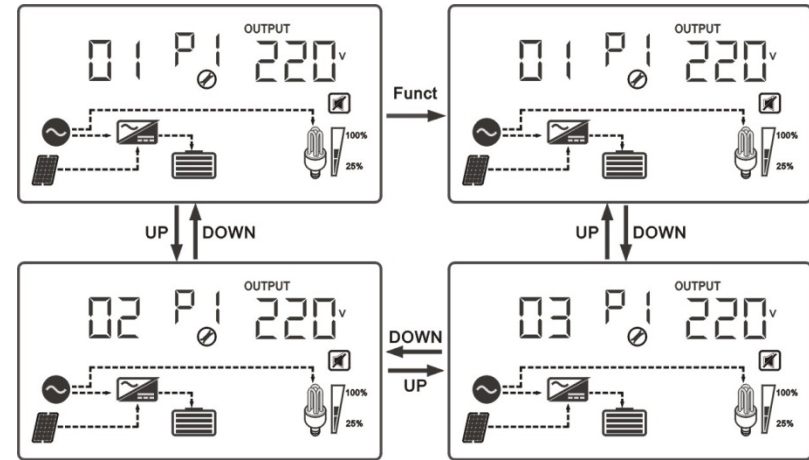
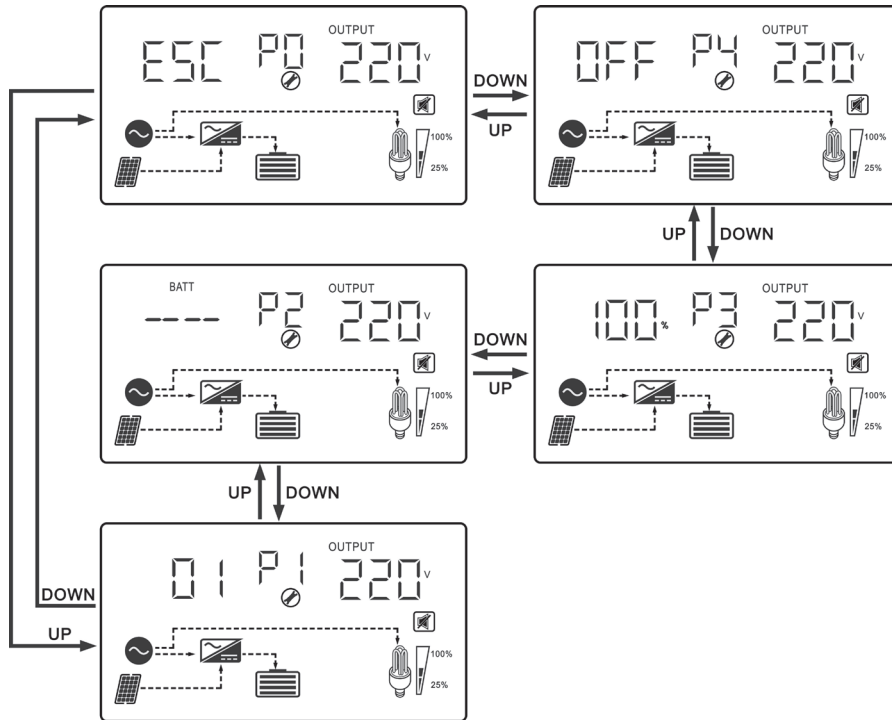

4 Device connection icon

4.1 Recommended line diameter

Battery, AC input / output connecting wire diameter recommended that: (1 mm² copper wire is calculated by current 4-5A).

$$\text{The battery connecting wire diameter} = \frac{\text{Power rating(W)}}{\text{Rated battery voltage(V)} * 5\text{A/mm}^2}$$

$$\text{AC connection wire diameter} = \frac{\text{Power rating(W)}}{\text{Rated AC voltage} * 5\text{A/mm}^2}$$

For example: 5000W/48VDC/220VAC equipment connecting wire diameter are as follows.

$$\text{The battery connecting wire diameter} = \frac{5000\text{W}}{48\text{VDC} * 5\text{A/mm}^2} \approx 20(\text{mm}^2)$$

$$\text{AC connection wire diameter} = \frac{\text{Power rating(W)}}{\text{Rated AC voltage} * 5\text{A/mm}^2} \approx 6(\text{mm}^2)$$

3.3.5.4 Inverter working mode setting

Under the main interface, long press the Function button for 5 seconds or less to enter the main menu, press the DOWN key to select the inverter work mode information P1, press the Function key to enter the setting interface, adjust the inverter work mode (01-03) through DOWN or UP key, press the Function key to save and exit.

con	Working mode	Operating condition
01	Mains priority (default)	The mains will give priority to the supply of power to the load. Solar and batteries provide electricity only when the mains supply is insufficient to provide power to the load.
03	Battery priority	Battery power preferentially supplies power to the load. The solar electricity charges the battery, which in turn supplies power to the load. Mains supply power to the load only when it is generated under any of the following conditions :1. When the battery power drops to low potential warning voltage, 2. When there is no solar power to charge the battery, The mains take over to supply power to the load.

3.3.5 Parameters Setting

3.3.5.1 Buzzer mode Settings.

Under the main interface, long press the Function button for 5 seconds or less to enter the main menu, press the DOWN button to select the buzzer information P4, press the Function button to enter the setting interface, turn on/off the buzzer state through DOWN or UP key, and press the Function key to save and exit.

On Indicates that the buzzer is on.

0FF Indicates that the buzzer is off.

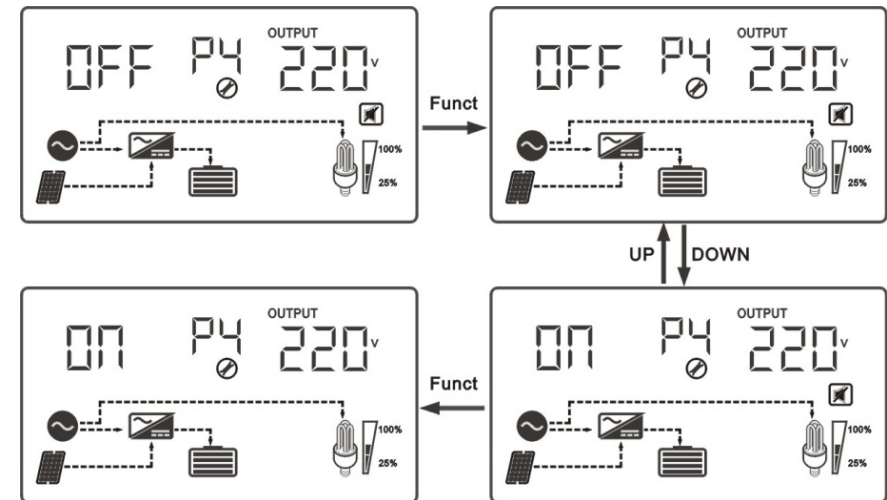

3.3.5.2 Inverter charging current setting

Under the main interface, long press the Function button for 5 seconds or less to enter the main menu. Press the DOWN button to select the inverter charging current information P3. Press the Function button to enter the setting interface. Through DOWN or UP button, increase /decrease The charge current of the inverter (100%-80%-60%-40%-20%). Pressed Function to save and exit.

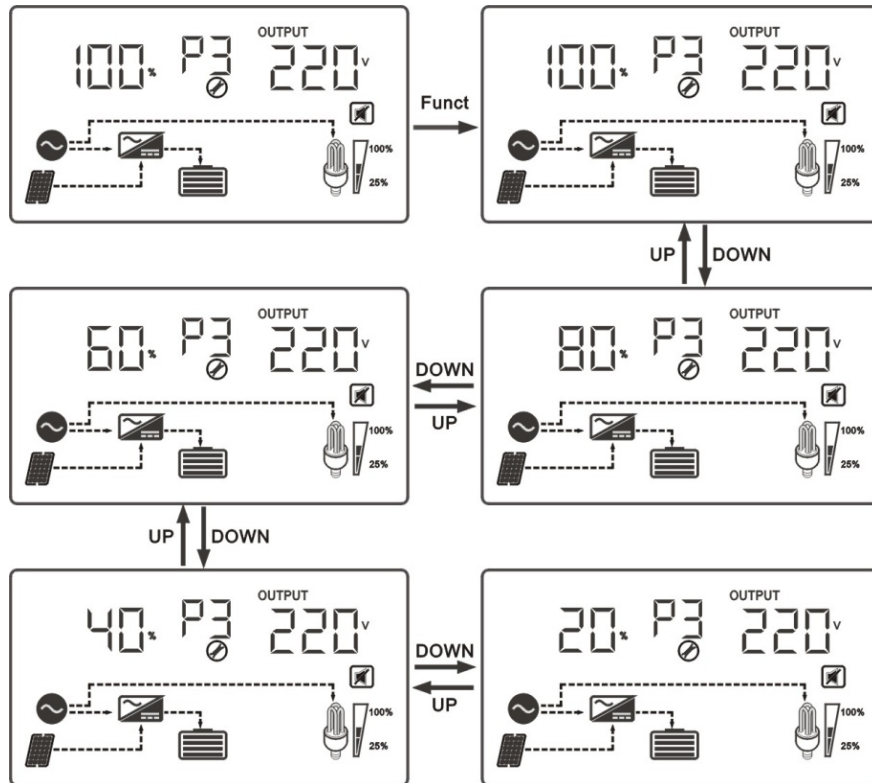

3.3.5.3 Error code and solution

Error code	Faulty	Solution
E01	Over current of MOSFETS board	Kindly contact sales if still having this issue after restarting
E02	Output short circuit	Check whether it's overloaded seriously or short circuit inside appliances loaded
E03	Appliance Overloaded	Check whether it's overloaded, and remove some loads not important
E04	Inner Over-temperature	Check whether fan is working well or the air dust for cooling be blocked
E05	Over voltage of battery	Check whether battery connection and configuration correct
E06	Battery's voltage is lower than shutdown voltage	Make sure battery be fully charged, or replace new battery
E07	Reverse connected cables between transformer with heat sink on power board	Fix the two cables after they are interchanged
E08	Start Protection when low output voltage	Kindly contact sales if still having this issue after restarting
E09	Reserved	-----
E10	Low voltage of battery	Check the system voltage of inverter and use same data for the battery pack.