



SP9100 8-Switch Programmable Switch Panel Power System

Read before installing!

Failure to follow installation instructions may affect warranty coverage

1. You **MUST** connect the Lt. Blue Ignition sense wire to an ignition or accessory source for the switches to operate. The default setting for all switches is “Ignition” controlled.
2. **Connect the black ground wire directly to the Negative terminal of the battery. DO NOT connect to frame ground studs or ground distribution studs.**
3. Do not connect any other power feeds to the power module’s power stud.
4. Do not use the SP9100 to control a winch. Use the winch manufacturer’s supplied device
5. Do not modify the switch panel communications cable.
6. Recommended installation of Power Module is the VERTICAL position, so that water runs off and does not collect on the top of the connector, or face of the module. Improper mounting will allow water to collect on the connector and allow for water intrusion and/or corrosion.
7. The use of a Terminal Block **IS NOT RECOMMENDED**, as wires are left exposed and susceptible to water and corrosion.

Installation should be performed by a qualified technician, to avoid damage to the system or output accessories.

Overview

The SP9100 Switch Panel Power system is a solid state switching system that is fully programmable and features Apple and Android Bluetooth accessibility and RGB backlighting.

The switch panel has 8 switches and one programming switch. A red led indicates when the switch panel is in programming mode and a blue led indicates when a Bluetooth connection is present.

The power module has 8 outputs, switches 1 – 4 are rated at 20A, and switches 5 – 8 are rated at 35A.

The power module also has 3 inputs, one Ignition sense, one Lights sense that can also be configured as an external trigger input Trigger 2, and one dedicated external trigger input Trigger 1.

The Trigger 1 and Trigger 2 inputs can be configured to sense active high or active low inputs. Both trigger inputs can switch on up to 4 outputs. The power module has 3 led indicators to display the status of each input.

The switch panel has an idle mode and a sleep mode. The idle mode will start after 1 minute of inactivity with a current draw of 5.5mA. The sleep mode will start after 8 hours (default) of inactivity which is adjustable in the App with a current draw of 3.0mA. *If switch panel backlighting is on, the system WILL NOT enter sleep or idle mode.*

The idle mode will activate when all switches are off, no Bluetooth connection, no Ignition, light, or trigger inputs.

In idle mode, the system will still respond to all inputs including switches and Bluetooth. The sleep mode will activate when all switches are off, no Bluetooth connection, no Ignition, light, or trigger input is sensed. In sleep mode Bluetooth is disabled, but all other inputs (except lights input), including switches will wake up the system.

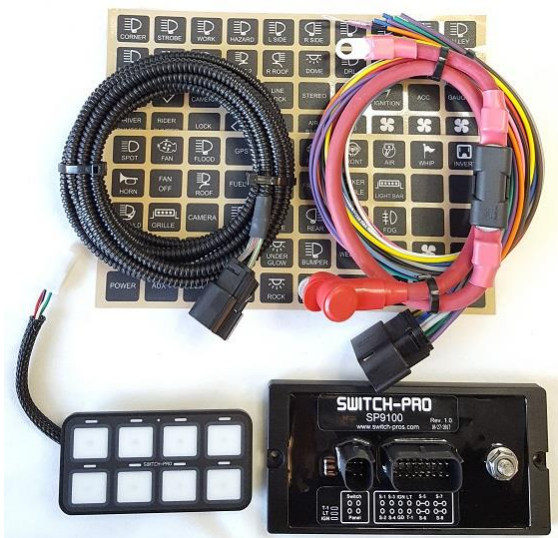

Installation

Disconnect the negative battery lead from the vehicle's battery before proceeding with installation, and to avoid damage to the electrical system!

See the last page for vehicle specific installations.

1. Installing the Switch Panel

Identify which accessories you will be powering with your Switch Panel Power System. Remember that Switches 1-4 are limited to 20 amps, and switches 5-8 are limited to 35 amps. Therefore, the accessories with the largest draws should be connected to switches 5-8.

Once your outputs are determined, select the appropriate legends from the Switch Legends sheet, and affix them to the panel. Center each legend inside the grey border of each switch. Should you need to remove a legend, we suggest you use a straight pin and lift at a corner until you can grasp it with your fingers. **DO NOT** dig at the graphic overlay, as the membrane could be damaged.

The switch panel can be mounted to a flat surface by drilling holes for the 6-32 mounting studs, and a hole for the harness feedthrough, then screwing the threaded studs into the switch panel and securing the switch panel with the supplied 6-32 nuts.

For a bezel style mount, cut a rectangular opening measuring 3.865" x 1.865" with a corner radius of 0.237". See Template on the last page.

Then screw the four 6-32 threaded studs into the backside of the switch panel and tighten. Place the switch panel into the opening and slide the two mounting brackets over the studs. Then secure the mounting brackets with the 6-32 nuts. Do not over tighten the nuts.

Connect the switch panel harness to the switch panel, then plug the black sealed connector into the power module connector. If the harness needs to be routed through a tight space in the firewall, the black 4-pin connector's pins can be removed, see directions on the next page.

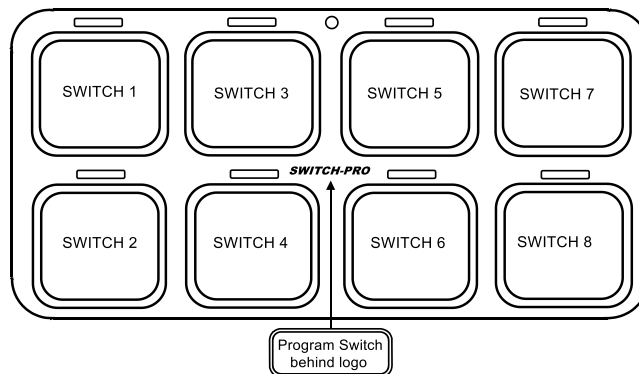

Switch panel harness connector removal

When installing the switch panel communications harness it might be necessary to remove the black MOLEX 4-pin connector **in order feed the harness through tight spaces**. Follow the procedure below to remove the terminals. Check the 4-pin Harness Connector pin-out drawing above for proper wiring.

Step 1: Insert a small screwdriver (max. width of 3.00mm (.118")) into the designated pry point of the TPA.

Step 2: Using the housing as a pivot point, gently pry out the TPA until it reaches pre-lock position.

The TPA should never be fully removed from the connector housing. Excessive force can damage the TPA

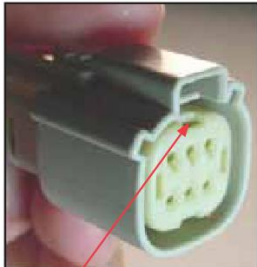

Pry Point

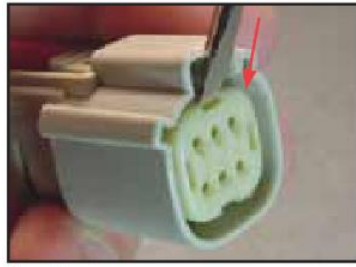

Step 1

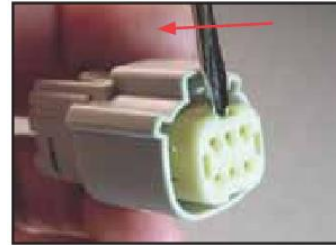

Step 2

Step 3: Using the 1.50mm (.059") service tool #63813-1500, or a paper clip, insert the tip into the terminal service hole adjacent to the terminal to be serviced. Push straight down gently and apply pressure to release-locking finger. This motion will release the locking finger, "picking" is not required. A click can be felt once fully engaged. Do not insert the service tool at an angle, this may cause damage to the terminal.

Gently pull the wire to be released. If the terminal resists, the service tool may not be fully engaged.

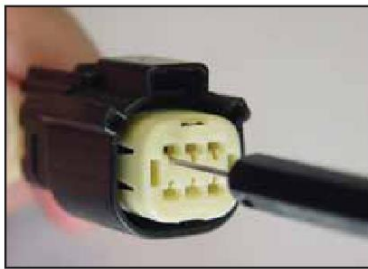

Step 3

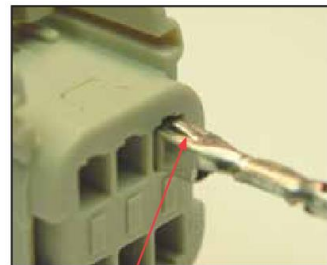

Correct Terminal Orientation

Step 4: When re-installing the terminal make sure the TPA is in the released position, and the orientation of the terminal is correct, see pic above, Once the terminal is seated, push down on the TPA applying even force.

2. Installing the Power Module

The power module should be mounted close to the vehicle's battery using the supplied 2 feet long battery cable. The power module is manufactured with automotive rated electronic parts, with a temp rating of -40 C to 125 C. Care must be taken though not to mount the power module in a location near the engine exhaust where temperatures will exceed the rating. Usually on the firewall near the fenders, or along the fenders is a good location. **Do Not mount the power module above the engine on the fire wall.** The App will display the temperature of the power module so it can be monitored. **Mount the power module in a vertical position, so that water can't accumulate on the connector seals. Failure to do so may result in limited or no warranty coverage.** The power module can be mounted to the supplied mounting plate using 2 M4 nuts and bolts (supplied). See drawing below:



3. Connecting Accessories

Identify which accessories you will be powering with your Switch Panel Power System. Remember that Switches 1-4 are limited to 20 amps, and switches 5- 8 are limited to 35 amps. Therefore, the accessory with the largest draw should be connected to Switches 5- 8.

To figure out the current draw of a load rated in watts, simply divide power rating of the accessory by the operating voltage. For example a 300 Watt light bar running at 12V, that would be: $300W/12V = 25 A$.

Keep in mind that for a lower voltage the current draw will be higher. If the vehicle's voltage drops down to 10V, the current will increase to 30 A. In this case it would be wise to set the over current limit to 35 A (using App).

Connect the accessory directly to the output wires of the power module. The SP9100 switches 12V to the accessory.

The power harness uses 14 AWG wires to power accessories. That is good for a load up to 20 A with a run no longer than 6 feet. For longer runs at max current it is recommended to use a larger size wire like 12 or 10 gauge.

For switches 5 – 8 with the higher amperage capacity both output wires **MUST** be connected together and spliced into a larger size wire such as 12 or 10 gauge.

Connect the power module output wire to the positive wire of the accessory. Connect the ground wire of the accessory directly to ground, either a ground stud on the vehicle's frame or to the negative terminal of the battery.

Current limits can be adjusted in the App in 5A increments. We recommend setting the overcurrent protection 15% to 20% higher than the maximum rated current of the accessory.

4. Control Wires

There are 3 control wires for external control of accessories and switch panel backlighting illumination.

- **IGNITION Input, Lt. Blue wire.** Enables ignition programmed switches and turns on backlighting to 70%. Connect this wire to an ignition or accessory 12V source. Use a T-tap to make the connection or solder and seal. When the Lt. Blue Ignition wire senses 12V, switches that are programmed to be “ignition controlled” are enabled. When the ignition signal turns off, all “ignition controlled” programmed switches, and their outputs, will turn off.
When the Lt. Blue ignition wire senses 12V, the red led indicator marked Ignition on the power module will illuminate.
The other option is to program individual switches to be “battery controlled”. When “battery controlled,” the switches will operate at all times.
Note: A Bluetooth connection overrides the Ignition input. All Ignition programmed switches will operate if the Ignition is Off, but a Bluetooth connection is present. This is so you aren't required to leave keys in the ignition while remotely controlling your accessories.
- **LIGHTS Input/T2, White wire.** Turns on switch panel backlighting to user set level. Trigger 2 input if enabled. Connect this wire to a parking light signal or a side marker light signal. Use a T-tap to make the connection or solder and seal. This wire is used to dim the switch panel backlighting for night time lighting. The backlighting and switch indicator led brightness intensity is set by pressing the programming switch (located behind the *SWITCH-PRO* logo) on the switch panel 3 times. Switches 1 and 2 adjust the led switch indicator brightness and switches 7 and 8 adjust the backlighting intensity. Once the intensities are set, press the program switch again to exit.
On Side by Side UTV vehicles, like Razors and CanAm's, that do not have parking lights, connect the White "Lights" wire to the Lt. Blue "Ignition" wire. Then connect both to an 12V ignition or accessory source.
- **Trigger 1 input, Pink wire.** External trigger input to turn on up to 4 outputs. Connect the Pink wire to an external trigger, it can be a high beam signal, reverse light signal, or a dome light signal to give a few examples. Use a T-tap to make the connection or solder and seal.
For example, if connected to the high beam signal, when turning on the high beams on the vehicle, up to 4 outputs of the switch panel will also turn on.
The function must be enabled in the App. The function can be turned on and off through the switch panel, to switch between off-road and street driving, by holding down the programming switch and pressing switch 7. Both Trigger 1 and Trigger 2 inputs can be programmed to trigger on an active high or active low signal in the App.

The control wire connections can be connected using the supplied Fuse-Tap or Tapa-Circuits:

When using the Fuse-Tap, it will come with a pre-installed fuse for the tap. Remove the fuse from the fuse box that needs to be tapped into, and insert it into the empty slot of the Fuse-Tap. Then insert the Fuse-Tap into the fuse slot. Crimp the desired input wire to the blue butt splice.

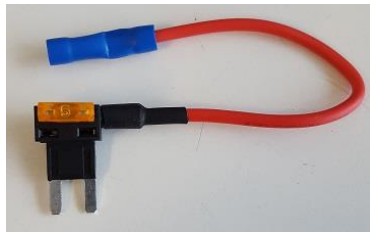

Fuse-Tap

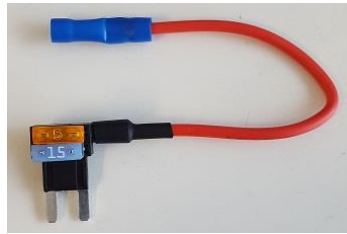

Fuse-Tap with fuse inserted.



1. Place wire in t-tap

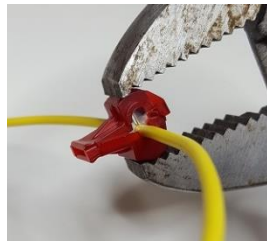

2. Crimp

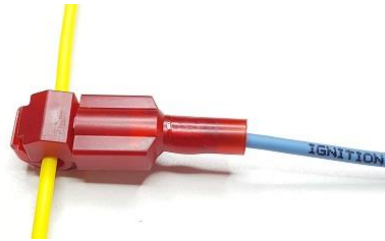

3. Plug in blade connector

5. Installing the Battery Cable

Make sure the 16-pin connector is plugged into the power module with the Black ground wire connected to the negative terminal of the battery before connecting the battery cable.

Install the battery cable once the power module is secured, the switch panel communications harness is plugged in and connected to the switch panel, and the 16-pin power module harness Black ground wire is connected directly to the negative terminal of the battery, and the Ignition and Lights wires are connected. Connect the battery cable to the power module first, then connect the fuse holder side directly to the positive terminal of the battery.

Battery Cable Connection

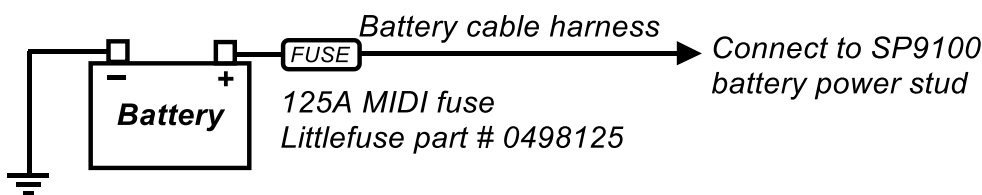

- Connect the Battery cable directly to the positive terminal of the battery.
- Connect the BLACK ground wire directly to the negative terminal of the battery.
- Only the battery cable lug should be connected to the power module's power stud,
- Do not connect any other power feeds to the power modules power stud!

Switch-Pro SP9100 125A Wiring Diagram

16-Pin Harness Connector Pin-out

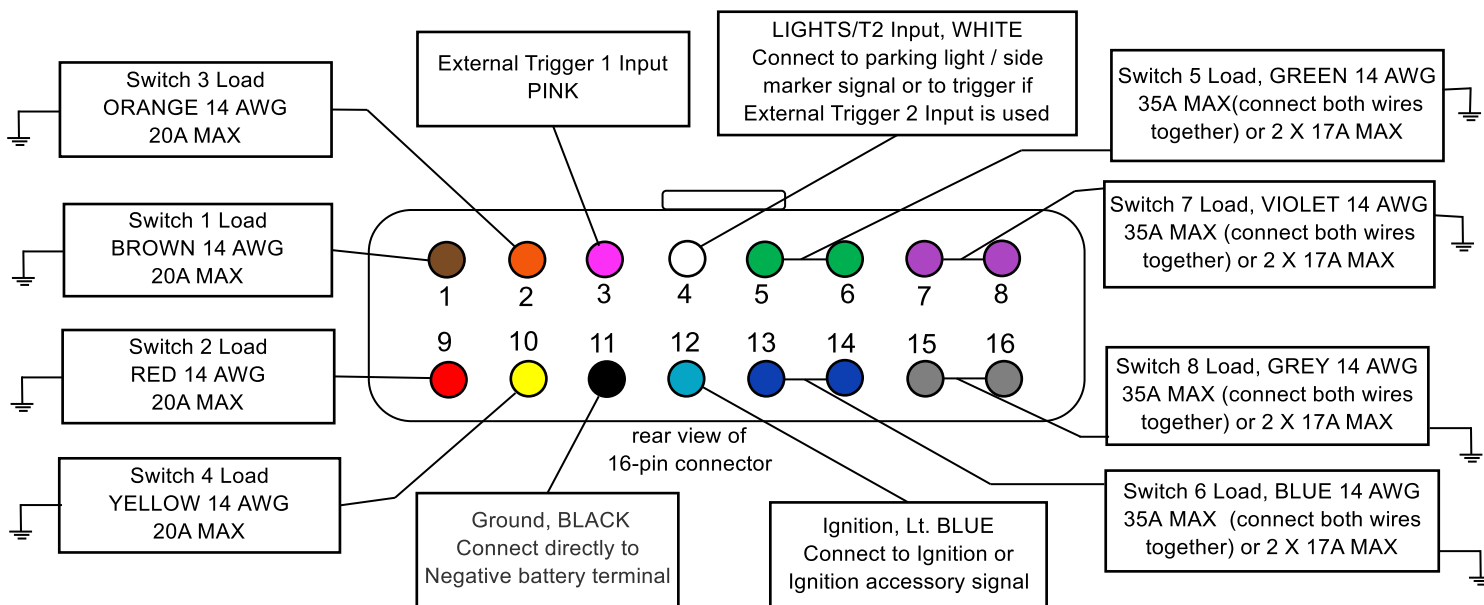

- Connect the switch load wires directly to the positive terminal of the load.
- Ground the negative terminal of the load to either a ground stud on the frame or to the negative terminal of the battery.
- Switches 1 - 4 are limited to 20A, switches 5 - 8 are limited to 35A. Current limits for each switch can be adjusted in the App.
- Connect the Lt. Blue ignition wire to an ignition or accessory 12V source.
- Connect the White light input wire to a parking light 12V signal. (used for switch panel backlighting dimming)
- Connect the Pink Trigger 1 input wire to a trigger input, if using the trigger function.
- Connect the Black ground wire directly to the negative terminal of the battery.

4-Pin Harness Connector Pin-out

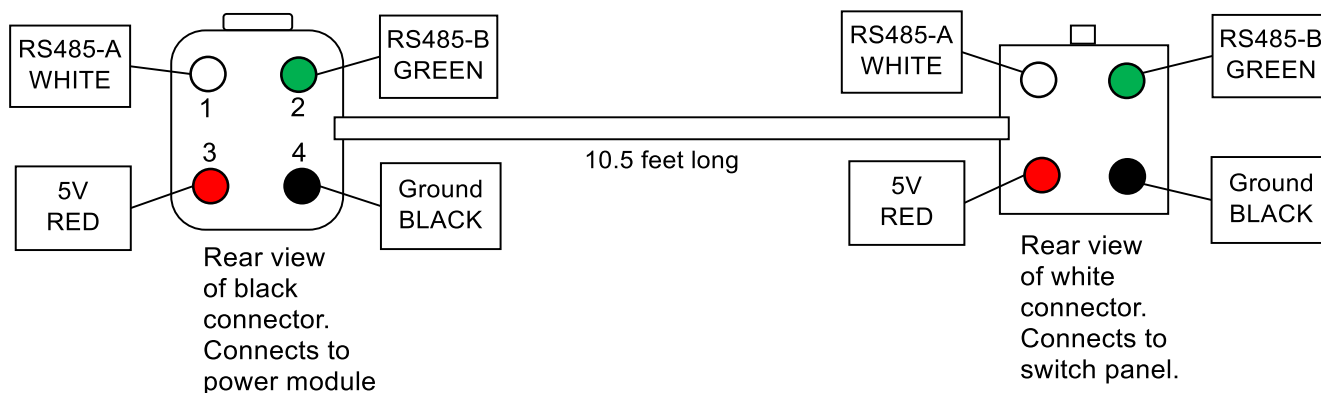

SP9100 Functions

In the App, scroll down to the left bottom of the screen and press the “Settings” button. The following programming bars will appear, tap the bar to enter the desired programming function.

1. *Config Switches*

- **ON/OFF or Momentary***, default is On/OFF
- **Ignition or Battery Control***, default is Ignition control.
The Lt. Blue Ignition wire must be connected to an ignition or accessory 12V source for switches to operate. Note: A Bluetooth connection overrides the Ignition input. All Ignition programmed switches will operate if the Ignition is Off, but a Bluetooth connection is present.
- **Flash function***, ON/OFF/One Touch, default is OFF.
When ON, the switch must be double-pressed for the flash function. One Touch only requires one switch press for a Flash.
- **Strobe function***, ON/OFF/One Touch, Burst or Continuous, default is OFF.
When ON, the switch must be double-pressed for the flash function. One Touch only requires one switch press for a Strobe.
- **Low Voltage Disconnect***, default is ON.
The LVD will turn off all outputs when the battery voltage drops below 11.0 Volts for 1 minute. This function’s purpose is to keep the battery from draining in case an output was left on.
- **Memory function***, default is OFF.
The memory function remembers the last switch status before the Ignition was turned off. If a switch was on when ignition was shut off, that switch will turn the back on when the ignition is turned back on.
- **Master Switch function**, Master ON or Master ON and OFF, default is Master function OFF.
Any switch can be programmed to be a master switch to turn ON any other switches. Master ON will turn the selected switches ON and must be turned OFF individually. Master ON and OFF will turn the selected group of switches ON and OFF.
- Items marked * can be directly programmed through the switch panel and do not require connecting through the App. See page 5.

2. *LED Backlighting*

- Use the slide bar to adjust switch indicator LED brightness and backlighting brightness and color, when the “LIGHTS” input WHITE wire senses 12V, (parking lights ON). Select switch panel backlighting color from either the RED, GREEN, BLUE or WHITE preset buttons, or touch the color picker bar to select any color in the spectrum.

3. *Set Switch Names*

- Enter switch names to appear in the App’s switch buttons. A space between characters will create a new line.

4. *Set Password*

- Enter a password for the App, write the selected password down in a safe place, as **we cannot unlock a password protected panel, if the password is forgotten.**

5. *Enable Output Dimming*

- Enables dimming of lights. All switch outputs are dimmable. The dimming function for each switch must be enabled in the App menu under settings/output dimming. When the dimming function is enabled, the switch will still function normal if pressed on/off. The dimming is actuated when pressing and holding the switch on for 1.5 seconds. The switch led indicator will start to flash fast for 1 second, indicating a 70% output. Then in 1 second increments the dimming will decrease to 50%, 30% and 10%. The switch led indicator flash rate will also decrease, indicating the level of dimming. When the desired dimming level is achieved, releasing the switch will lock in the dimming level. The level is not stored, and resets each time the switch is powered off. The next time the switch is turned on and dimmed, the level will start at 70% again.

6. *Calibrate Readings*

- In the event that the Battery Voltage or Temperature readout in the App is off, they can be calibrated by pressing the Increase or Decrease buttons.

7. *Set Radio Name*

- The name of the Bluetooth radio can be changed, limited to 8 characters. This is the device name of the SP9100 switch panel that will appear after pressing “scan for devices”. It can be changed in the App settings menu under “Radio Name”. The default name is “SWCHPRO.” This is useful when there are multiple panels within Bluetooth range.

8. *Auto Sleep Setting*

- The switch panel system will enter sleep mode after the preset time (8 hours default), drawing a minimal amount of current (3mA).
(The normal current draw of the system is around 35mA. After 5 minutes of inactivity, the system will go idle and the current draw will drop to 6mA (with all switches off and no Ignition, Lights and Trigger inputs). In idle mode the switch panel can still be accessed via Bluetooth).
In sleep mode, Bluetooth and switch control is disabled. Default setting is “enabled” after 8 hours of inactivity. The system will “wake up” with an input to the Ignition, Trigger inputs, or if any switch on the switch panel is pressed. Control and time (adjustable 0 to 65500 minutes) for the automatic sleep mode can be found the App under settings/sleep mode.
The system can also be put into sleep mode instantly (no delay) through the switch panel by pressing and holding the programming switch and pressing switch 5. The programming led will flash 3 times for indication.
For the system to enter sleep mode the system must be completely idle, Ignition, light and trigger inputs must be off, all outputs must be off, and no Bluetooth connection can be present.
The automatic sleep mode function with the programmed delay can also be turned on through the switch panel by pressing and holding the programming switch and pressing switch 4. The programming led will flash 3 times for indication.
The automatic sleep mode function can also be disabled by pressing and holding the programming switch and pressing switch 3. The programming led will flash 3 times indicating that you have deactivated the function.

9. *External Trigger*

- This function uses the PINK Trigger 1 wire and the WHITE Light input wire Trigger 2 input to turn on up to 4 outputs each. Each trigger input can be programmed to trigger on an active high (12V signal) or an active low (ground signal).
- For Trigger 1, PINK wire.
Connect the Pink wire to an external trigger, it can be a high beam signal, reverse light signal, or a dome light signal to give a few examples. For example, if connected to the high beam signal, when turning on the high beams on the vehicle, up to 4 outputs of the switch panel will also turn on. The function can be turned on and off, with the switch panel to switch between off-road and street driving, by holding down the programming switch and pressing switch 7.
On the switch panel, hold the programming button and press switch 7. The programming led will flash 3 times, indicating the function is on. To turn the function off, press and hold the programming switch and press switch 7. The programming led will flash once, indicating the function has been turned off.
- For a Trigger 2, the WHITE, “Light” wire input can be converted to a trigger input by enabling the Trigger 2 in the App.
Switch panel backlighting dimming that was previously using the White wire is now activated with the Lt. Blue ignition wire signal. The Lt. Blue ignition wire is still connected to an ignition source for the ignition input, but will also turn on the backlighting to the user adjustable level.
The function can be turned on and off, with the switch panel to switch between off-road and street driving, by holding down the programming switch and pressing switch 8.
On the switch panel, hold the programming button and press switch 8. The programming led will flash 3 times, indicating the function is on. To turn the function off, press and hold the programming switch and press switch 8. The programming led will flash once, indicating the function has been turned off.

10. *Temperature Units*

- Select between degrees Celsius and Fahrenheit, displayed in the App, for the power module temperature.

11. *Setup Connected Units*

- This function is used to setup daisy chained switch panels. Up to 3 switch panels can be connected to a single power module. The Master switch panel will always have an address of “0”, additional daisy chained switch panels will be “Slaves” with unique addresses. More info coming soon.

12. *Power-up switch status*

- This function programs any switch to turn ON whenever power is connected to the power module or the Lt. Blue Ignition wire senses 12V (Ignition turns ON), regardless of the previous switch status. The switch can still be turned off on the switch panel. Can be used for day time running lights or dust lights.

13. *Off Delay Switch Settings*

- This function programs an off-delay time function, in seconds, into any switch that is triggered by the Lt. Blue Ignition signal wire. The timer will start after the Ignition is turned off. Max off-delay time is 18000 seconds or 5 hours. The off-delay function will NOT activate with switches turned on by an external trigger, or a Bluetooth connection turned on switch.

If an off-delay of 10 seconds was programmed for a switch, and if the switch was turned on and the Ignition was turned off, the switch will remain on for 10 seconds. Used for fans, oil coolers or lighting to stay on for a set period of time after the ignition is turned off.

14. *Switch Overcurrent Values*

- This function sets up the overcurrent values, in Amps, of each switch. Switches 1-4 are limited to 20 amps, and switches 5- 8 are limited to 35 amps. Each overcurrent value can be adjusted in 5A increments. This is the current limit that is allowed, for each switch. Any value over the limit for longer than 0.5 seconds will trip the circuit. The switch indicator led will flash 3 times indicating there is a fault. Only the affected switch output will turn off and reset.

15. *SPDT and SP3T Switch Configuration*

- This function allows the user to program a SPDT and SP3T function into selected switches. Only one of the selected switches can be on at one time. When pressing another switch, the previously pressed switch will turn off. For a SPDT function, select Output 1 and Output 2. For a SP3T function, select all 3 outputs. This function, for example, can be used for fan setting controls or suspension setting controls.

Programming Your SP-9100 Using the Bluetooth Function

The Switch-Pro App will interface with Apple devices and Android devices running BLE and newer

1. Download the Switch-Pro App from the Apple App or Google Play Store.
2. Open the app and press Scan For Local Devices. A window will pop up. Press Scan For Devices in that window. Select the listing that reads SWCHPRO. The app will load and establish connection to the Switch Panel. NOTE: On the primary screen, make sure that “Auto Connect” and “Reset BT adapter on connect” are **unchecked**. Once a connection has been established, “Auto Connect” can be checked. With “Auto Connect” checked, the App will open automatically when the App Icon is pressed.
3. Once the App is open, the Switch Panel is displayed with Voltage and Temperature display, and the blue light will illuminate on the switch panel.
4. Scroll down to the left bottom of the screen and press the “Settings” button. From there you will see the different programming options, see the SP9100 functions page for details.
5. In the Settings menu you will be able to set a password for the Bluetooth connection, under the “Set Password” tab. You will also be able to name the Bluetooth device with a personalized name that will show up on your phone when you press scan for local devices, under the “Radio Name” tab.

NOTE: If there is a BT connection established, the Switch Panel in the vehicle will also be functional, **regardless of Battery/Ignition Switch programming**. This means that if you remove the keys from the vehicle, AND your Bluetooth device is still connected, ALL switches on the switch panel will function, even if they are programmed as Ignition input. If the Bluetooth device is disconnected, then the switches on the switch panel that are programmed for Ignition input will only function with the ignition on.

If Bluetooth connection is lost, or app is closed while outputs are on, outputs will remain ON.

NOTE: When entering the Settings/Program mode, all switch outputs will turn off.

Special Switch Functions Control

Bluetooth connection, Sleep mode, and External Trigger functions can be controlled through the switch panel by pressing and holding the programming switch and then pressing and releasing the desired function switch.

- **Bluetooth Control:**
Bluetooth control can be disabled by pressing and holding the programming switch and pressing switch 1. The programming led will flash 3 times for indication. Bluetooth connection must be off when disabling Bluetooth. Bluetooth control can be enabled by pressing and holding the programming switch and pressing switch 2. The programming led will flash 3 times for indication.
- **Sleep Mode Control:**
Sleep Mode control can be disabled by pressing and holding the programming switch and pressing switch 3. The programming led will flash 3 times for indication. Sleep Mode control can be enabled by pressing and holding the programming switch and pressing switch 4. The programming led will flash 3 times for indication.
- The system can be put into sleep mode instantly (no delay) through the switch panel by pressing and holding the programming switch and pressing switch 5. The programming led will flash 3 times for indication. For the system to enter sleep mode, Ignition, light, and trigger inputs must be off, all outputs must be off, and no Bluetooth connection can be present.
- **Trigger Input Control:**
The Trigger controls must first be setup in the App, then they can be turned on and off through the switch panel as follows:
Trigger 1 control can be disabled by pressing and holding the programming switch and pressing switch 7. The programming led will flash once for indication. Trigger 1 control can be enabled by pressing and holding the programming switch and pressing switch 7. The programming led will flash 3 times for indication.
Trigger 2 control can be disabled by pressing and holding the programming switch and pressing switch 8. The programming led will flash once for indication. Trigger 2 control can be enabled by pressing and holding the programming switch and pressing switch 8. The programming led will flash 3 times for indication.

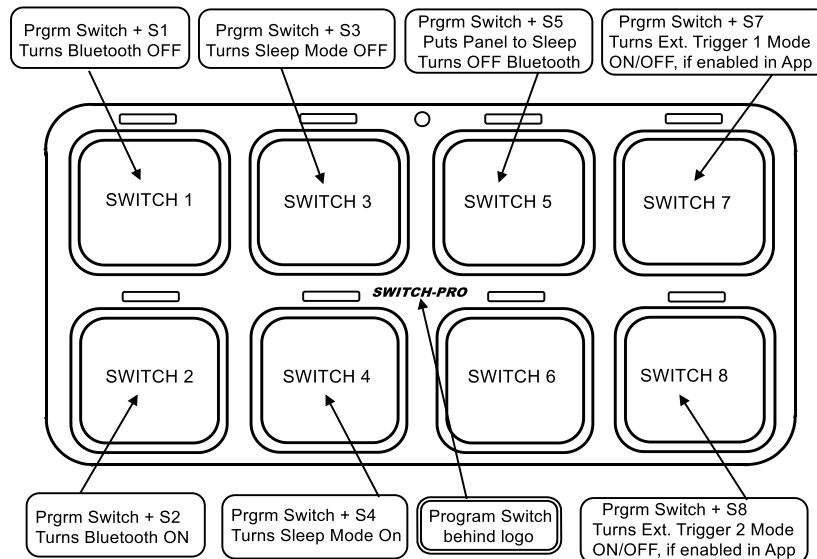

Programming your SP9100 through the switch panel

Basic switch functions like ON/OFF-Momentary, Ignition-Battery, Flash, Strobe, Low Voltage Disconnect, and the Memory function can be programmed directly through the panel and do not require a Bluetooth connection. Switch panel backlighting and switch indicator led brightness can also be programmed directly through the switch panel. Follow the directions below:

1. Press and hold the programming switch on the switch panel located behind the *SWITCH-PRO* logo for 6 seconds to activate programming mode. The 1st flash indicates you are ready to select which switches should have a Momentary function. (Default for all switches is On/Off). Press Switch-Pro logo again to continue programming process.
2. The 2nd flash indicates you are ready to select which switches should be Battery input. Any switch selected during this step will REMAIN ON, even when vehicle ignition is turned off. (Default for all switches is Ignition input, unless selected during this step). Press Switch-Pro logo again to continue programming process. Select ALL switches that you wish this to apply to.
3. The 3rd flash indicates you are ready to select which switches will have a Flash function. This will be used for lighting outputs. Any switch selected during this step will have a secondary Flash function when the switch is double tapped from the Off position. (Default for all switches is Off, or no flash function). Press Switch-Pro logo again to continue programming process.
4. The 4th flash indicates you are ready to select which switches will have a Strobe function. This will be used for lighting outputs. Any switch selected during this step will have a secondary Strobe function when the switch is double tapped from the Off position. (Default for all switches if Off, or no Strobe function). Press Switch-Pro logo again to continue programming process.
5. The 5th flash indicates you may override the Low Voltage Disconnect function, if desired. If left active, the system will monitor battery voltage and, if it senses voltage at 11.5 volts or lower for 60 seconds, it will shut down. If, after shut down, it sees the voltage rise to 12 volts for 60 seconds, the system is able to be powered on again. However, it will not turn back on automatically. To DISABLE this function, press Switch 7, located at the upper right corner of the panel. (Default for system is On). Press Switch-Pro logo again to continue programming process.
6. The 6th flash indicates you are ready to select which switches will have a Memory function. Each switch selected during this step will “remember” to come back on each time the ignition input is sensed, if the switch was On prior to ignition being shut off (Default is Off).

Press the Switch-Pro logo again to exit the programming process.

To adjust Night-time backlighting and LED indicator brightness:

1. Press the Switch-Pro logo 3 times quickly.
2. Switches 1 and 2 (upper and lower left corners) adjust the LED indicator brightness. Press Switch 1 (upper left) to increase brightness. Press Switch 2 (lower left) to decrease brightness.
3. Switches 7 and 8 (upper and lower right corners) adjust the backlighting brightness. Press Switch 7 to increase brightness. Press Switch 8 to decrease brightness.

Press Switch-Pro logo to exit the programming process.

NOTE: Backlighting and LED brightness is adjustable only for nighttime driving (when the White “Lights” wire senses 12V), and is set at a standard level, 70% (non adjustable) when the Ignition is sensed on.

Power Module:

Size: Width 3.0", Length 6.0", Height 0.5",
Height with connectors 1.40",
Height with connectors plugged in and wires 3.0"
Material: Anodized Aluminum
Temperature rating: Automotive -40C to 125C
Water and Dust proof rating: IP67
Amp rating: 125A max
Switch 1 – 4 Outputs: 20A max
Switch 5 – 8 Outputs: 35A max
Current draw: 35mA
Current draw: At idle, after 1 min no activity, 5.5mA
Current draw: In sleep mode, 3mA
Inputs voltage thresholds active HIGH: >4.5V
Inputs voltage thresholds active LOW: <0.5V

Switch Panel:

Size: Width 2.0", Length 4.0", Height 0.375"
Housing material: Anodized Aluminum
Switch Membrane and Legends material: Polycarbonate
Temperature rating: -30C to 85C
Water and Dust proof rating: IP67
Backlighting color: RGB
Switch led indicator color: Amber
Bluetooth: BLE 4.1 Apple and Android

Switch Panel Mounting Template

- For a switch panel bezel mount, cut out the white inside of the template, do not cut the black line.
- For mounting onto a flat surface, mark holes for the mounting studs and the harness hole.
- Make sure the inside measurements of the template are 1.875" x 3.875" (0.237" corner radius) since they can vary due to printing parameters.

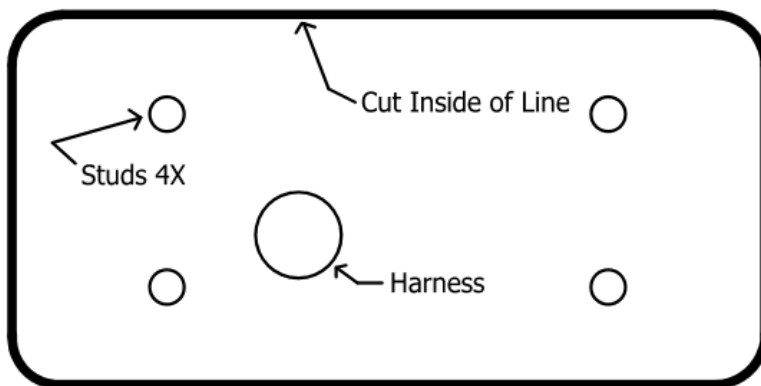

Note: Inside of black perimeter line (white area) should measure 1.875 x 3.875" with a .237" corner radius

Vehicle Specific Installations:

Jeep JK 2007 to 2017

Power module mounting:

Mount the power module on the passenger side firewall above the battery.

Secure the Power Module to mounting plate, using 2 M4 screws and 2 M4 nuts with locking washer. Nuts must be placed on the front of the PM, due to limited clearance on the back side. Install the M6 bolts into the plate and secure with M6 nuts. Remove the plastic 'stud covers' (which are attached to the wire loom running along back wall of engine compartment). Place Mounting Plate/Power Module assembly onto factory wire harness studs, and secure with M6 Nuts with nylon inserts (Figure 3). Place the factory plastic 'stud covers' over the mounting plate studs.



Ignition Connection:

Connect the Lt. Blue Ignition wire to the M6 fuse using the Fuse-Tap in the fuse box next to the battery.

Or, connect the Lt. Blue Ignition wire to the Blue with Pink stripe wire at the C6 connector at the bottom of the fuse box, see figure 3.

Light Input Connection:

Connect the White "LIGHTS" wire to the white wire with green stripe, which comes from the fender side marker light.

Or, the connection can also be made at the bottom of the fuse box, green connector, White with Brown stripe wire, see figure 2.

Lift up the TIPM by unlatching the 4 retaining clips, to gain access to the bottom connectors, see figure 1.

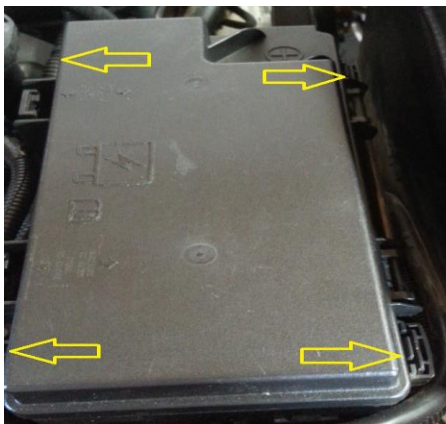

Figure 1.



Figure 2. Parking light wire



Figure 3. C6 connector, Blue/Pink wire

Polaris RZR

1. Install the power module near the battery and connect the 4 AGW battery cable directly to the positive terminal of the battery. The battery connection can also be switched with a main cut-off switch.
Connect the BLACK negative ground wire coming out of the 16-pin connector, directly to the negative terminal of the battery. The power module can also be mounted at the front of the vehicle, but both the power feed and the Black ground wire need to be connected directly to the battery. DO NOT rely on a frame ground for the Black ground wire.
Connect the Lt. Blue Ignition and White Lights wire together and connect them to the ACC terminal (Orange wire) on the terminal block located at the front of the vehicle under the hood.
Note: On the Factory terminal block, only the Orange ACC wire is connected to the terminal block. The studs marked GND and Power are not connected. (The GND stud is not grounded).
2. Install the switch panel and route the 11' switch panel cable to the power module. A common place to mount the switch panel is to the left of the steering wheel.

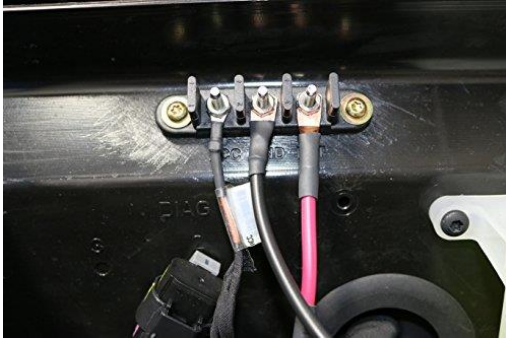

CanAm X3

3. Install the power module near the battery and connect the 4 AGW battery cable directly to the positive terminal of the battery. The battery connection can also be switched with a main cut-off switch.
Connect the BLACK negative ground wire coming out of the 16-pin connector, directly to the negative terminal of the battery. The power module can also be mounted at the front of the vehicle, but both the power feed and the Black ground wire need to be connected directly to the battery. DO NOT rely on a frame ground for the Black ground wire.
Connect the Lt. Blue Ignition and White Lights wire together and connect them to the ACC terminal of the terminal block located under center console. Remove the passenger seat for 2-seater or rear passenger seat for 4-seater, and pull the center console and you will find the accessory power terminal. The ACC terminal is the bottom stud.

