

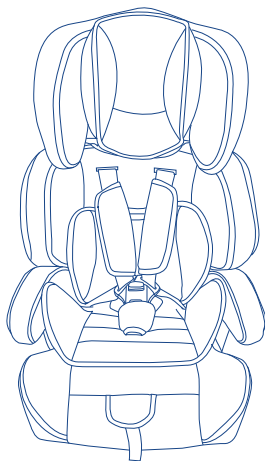

## INSTRUCTION MANUAL



EST-123  
Group 1/2/3  
9kg to 36kg  
(Approximately 1 year - 11 years)

ECE R 16 No 44.04

# EST-123 Car Seat

Congratulations on the purchase of your Cozy N Safe Car Seat.

You have made an excellent choice; every product has been tested to exceed required safety standards and is manufactured using high quality materials and components.

Our aim is to produce products that will help your child develop and will make learning new skills an enjoyable experience for both infants and parents. We appreciate that time with your child is precious and hope that the purchase of this product will enhance your time together.



# EST-123 Car Seat

## NOTICE

This is a Universal child restraint. It is approved to ECE R44/04 series of amendments, for general use in vehicles and it will fit most, but not all car seats.

A correct fit is likely if the vehicle manufacturer has declared in the vehicle handbook that the vehicle is capable of accepting a Universal child restraint for this age group.

This child restraint has been classified as 'Universal' under more stringent conditions than those which applied to earlier designs which do not carry this notice.



# EST-123 Car Seat

Child restraint system suitable for:

Children from 9 - 18kgs (Group 1 with the safety harness)

Children from 15 - 25kgs (Group 2 with the backrest or without the backrest)

Children from 22 - 36kgs (Group 3 without the backrest).

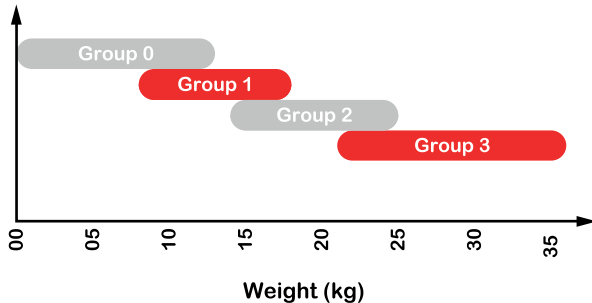

Only suitable if the approved vehicles are fitted with 3 - point safety belts approved to UN/ECE Regulation No. 16 or other equivalent standards.

# SAFETY WARNINGS

# EST-123 Car Seat

PLEASE READ THOROUGHLY BEFORE  
COMMENCING INSTALLATION, AS AN  
INCORRECT INSTALLATION COULD BE  
DANGEROUS.

# EST-123 Car Seat

Parents should not under any circumstances use this child restraint on a passenger seat equipped with an airbag.

The child seat must only be installed in the forward facing position.

It is most important that the seat belt is correctly routed and the child seat tightened down on the upholstery as firmly as possible to ensure maximum protection.

It is dangerous to make any alterations or additions to the car seat without the approval, and it is dangerous not to follow the installation instructions provided.

# EST-123 Car Seat

Recommends that this car seat must not be used when it has been subjected to the violent stresses in a motor vehicle accident.

Do not leave the child in their child restraint unattended.

Ensure that no part of the seat or seat belt is trapped in a door or a folding seat. If your car has a folding rear seat, ensure that it is correctly latched in its upright position.

This car seat is provided with a fabric cover. It should be kept away from sunlight as it may become too hot at times for the child's skin.





# EST-123 Car Seat

The safety belt buckle is not fully tamper proof and therefore your child should be taught to never play with it.

It is important to ensure that the lap strap is worn low down as this secures the pelvis.

The rigid items and plastic parts of a child restraint must be located and installed so that they are not liable during everyday use of the vehicle by becoming trapped by a movable seat or in a door of the vehicle.

Only suitable if the approved vehicles are fitted with 3 point safety belts approved to UN/ECE R16 or other equivalent standards.



# EST-123 Car Seat

The child restraint must not be used without the cover. Should not be replaced with anything other than the one recommended by the manufacturer as the cover constitutes an integral part of the restraint performance.

Can only guarantee the seat when the original owner uses it.

Remove the headrest of the passenger seat being used if it causes an obstruction for proper installation of the seat, but do not forget to refit the headrest after use.

When the child seat is not in use, it is recommended that it is fastened into the car with a seat belt to avoid it being thrown in the event of an accident.



# EST-123 Car Seat

In an emergency your child can be released quickly by pressing the red button on the seat belt buckle.

Store this child seat in a safe place when it is not being used. Avoid placing objects on top of it.

If you travel with passengers using both the front and rear passenger seats, the lighter occupants should be in the rear and the heavier occupants in the front of the vehicle.

Do not allow your child seat to come into contact with corrosive substances e.g. battery acid.

# EST-123 Car Seat

It is recommended that any straps holding the restraint to the vehicle should be tight, so the strap can not be twisted.

It is recommended that any luggage or other objects liable to cause injuries in the event of a collision should be properly secured.

Do not use any load bearing contact points other than those described in the instructions and marked in the child restraint.

Please keep these instructions for future reference.



# EST-123 Car Seat

## WARNING

Your child seat can only be fitted into the passenger seat of a car with a lap and diagonal seat belt and without an airbag. Do not use any load bearing contact points other than those described in the instructions and marked in the child restraints. The vehicle seat buckle is not positioned in or in front of the specified (labelled) belt guide of the child restraint system.

### **EXTREME HAZARD**

Do not use in passenger seats  
equipped with airbags (SRS)

The correct use and maintenance of your car seat will ensure it gives long and trouble free use. When somebody else is using your car seat, ensure they also know how to use it, especially the correct way to adjust it. The safety of your child is your responsibility.



# EST-123 Car Seat

## THE TYPE OF APPROVED SEAT BELT YOU MUST HAVE

Your child seat can only be installed forward facing using 3-point safety belts in the front or rear passenger seat of the car (Fig. B).

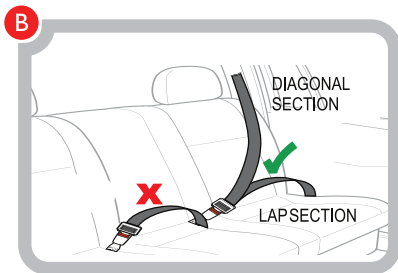

The safety seat cover is easily removable and can be cleaned by using neutral soap and cold water. Do not tumble dry. Do not iron the cover. Plastic parts can be cleaned by using damp cloth, do not use any solvents.

DO NOT place a car seat on the front seat with an air bag unless it is deactivated. DEATH or SERIOUS INJURY can occur. See your vehicle owner's manual for car seat positioning instructions. The back seat is the safest place for children 11 years and under.

This car seat must only be used in forward facing vehicle seats. Side facing or rear facing seats CANNOT be used. For questions about positioning the car seat consult the vehicle owner's manual. Some vehicles have no seating positions which are compatible with this car seat or any other child seat. See diagram below.

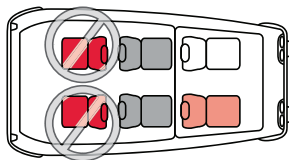
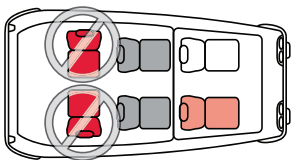
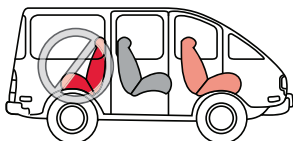

# EST-123 Car Seat

## Parts

**1x Backrest**

**1x Booster Seat**

**1 x Reversible Head Cushion**

**1 x Reversible Liner Cushion**

**1x Safety Belt Buckle (detachable)**





# EST-123 Car Seat

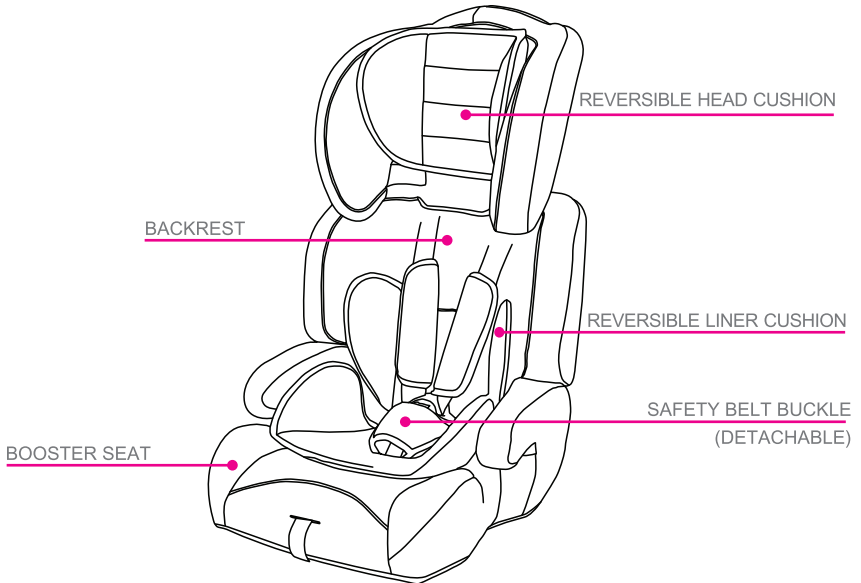

# EST-123 Car Seat Assembly before use

To set up your car seat, remove all packaging and set down on a flat surface. Your child seat consists of 2 parts, the booster seat and back rest. Ensure that both pieces are lying flat and facing upwards before assembly (Fig A)

Place the 2 hooks that are located at the bottom of the backrest over the bars that are located on the booster seat section. Ensure they are correctly aligned.

Place one hand over the join where the hooks rest over the bars and hold firmly in place and at the same time with your other hand, slowly lift the backrest into the upright position. (Fig B)

**WARNING:DO NOT FORCE THE BACKREST INTO THE UPRIGHT POSITION UNTIL IT IS ALIGNED OR DAMAGE MAY OCCUR.**



# EST-123 Car Seat Assembly before use

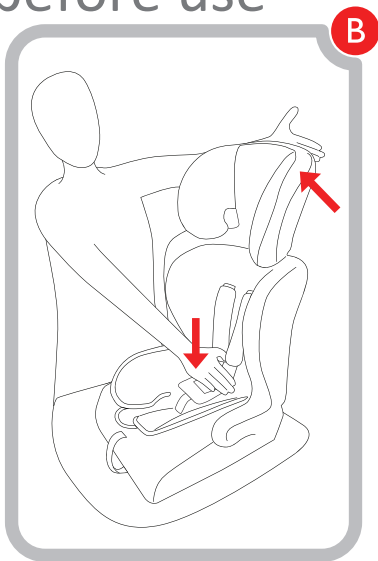
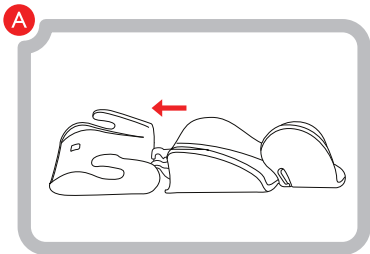

# EST-123 Car Seat

CORRECT FITTING POSITION OF  
THE SHOULDER STRAPS:

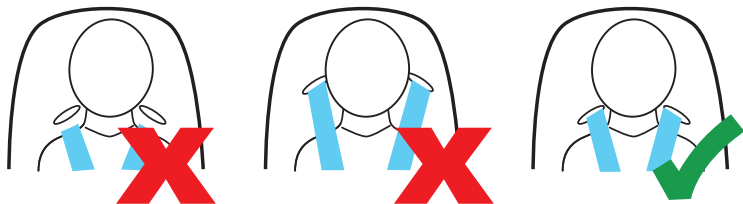

Loosening the shoulder straps:

To loosen the shoulder straps you must press the metal harness release lever and pull forward on the shoulder straps with your other hand.

# EST-123 Car Seat

## ADJUSTING THE HARNESS

In the centre of the base of the booster seat, underneath the material flap, you will find a small button. Pressing this will release the harness and allow you to manoeuvre the harness into a position that best fits your child. As your child grows, remove the support pad and adjust the harness by removing the shoulder straps individually from the metal slider plate on the back of the seat and interting them through the higher slots. then re-attach the shoulder straps individually.

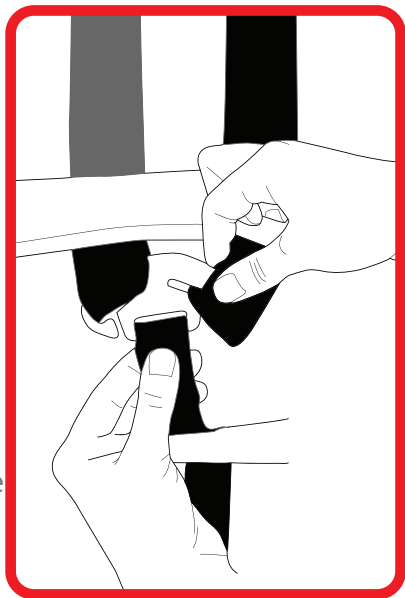

# EST-123 Car Seat

## SECURING YOUR CHILD IN THE HARNESS

1. Open the belt buckle. Put your child comfortably with his/her back against the shell and make sure that there are no toys or other hard objects in the shell.

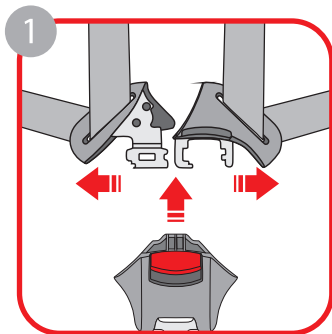

2. Slide buckle tongue sections together.

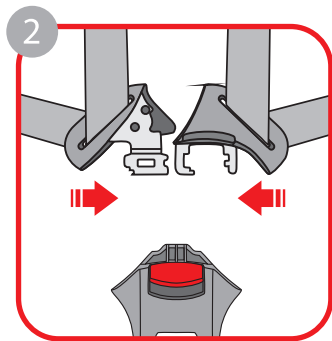

Caution! Do not twist or interchange the shoulder straps.

# EST-123 Car Seat

3. Insert them in the buckle with an audible "click". Once inserted, pull the shoulder straps tight.

CAUTION: Pull the straps straight towards you, not upwards or downwards.

4. Pull the remaining slack out of the strap system and pull the strap tight by the adjuster belt.

**For the safety of your child, please check that...**

- The shoulder straps of the car seat are **comfortable but fit securely around your child.**
- The shoulder straps are adjusted correctly.
- The shoulder straps are not twisted.
- The buckle tongues are engaged in the harness buckle

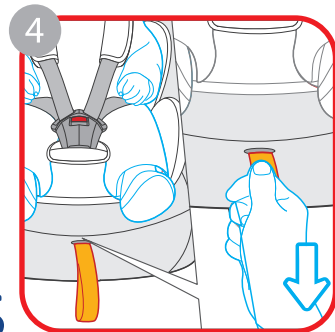
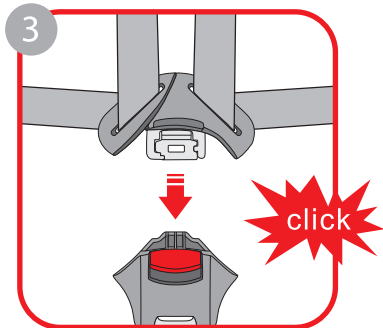

# EST-123 Car Seat

## TIGHTENING THE SHOULDER STRAPS:

To tighten the shoulder straps you must pull down on the adjuster strap (Fig 5) until achieving the fit and tension required. The harness should be adjusted as tightly as possible without causing discomfort to your child.

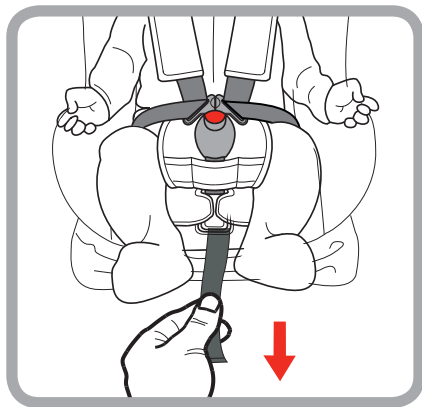



# GROUP 1

# EST-123 Car Seat

**GROUP**

**1**

**(9 - 18kgs)**

1. To fit your Cozy N Safe Logan Car Seat on the rear passenger seat with the car's 3-point safety belt system, ensure that the seat is upright and as close to the passenger seat cushion as possible.

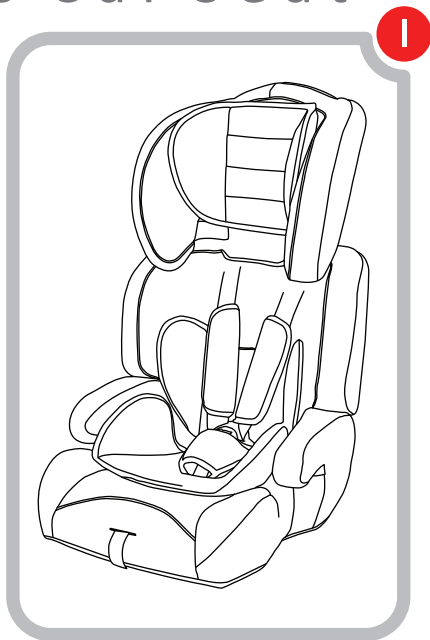

**C | S**  
— COZY N SAFE —

# EST-123 Car Seat

**GROUP**

**1**

**(9 - 18kgs)**

2. Thread the diagonal vehicle seatbelt through the fabric seat belt slot (marked by a red arrow) and the lap strap under the 'arm' of the booster seat.

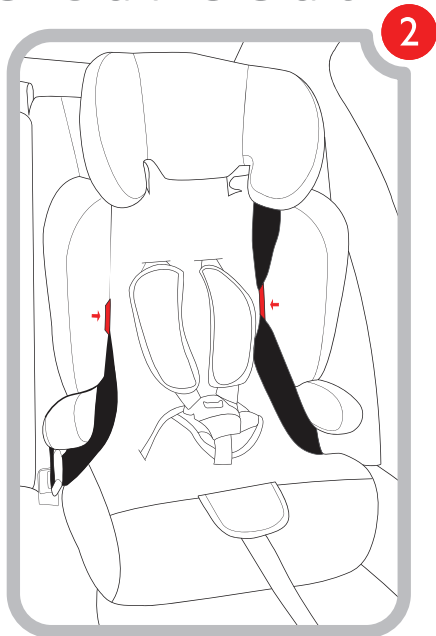

**C | S**  
— COZY N SAFE —

# EST-123 Car Seat

**GROUP**

**1**

**(9 - 18kgs)**

3. Pass the seat belt through the back of the seat (underneath the harness straps), and through the parallel seatbelt slot.

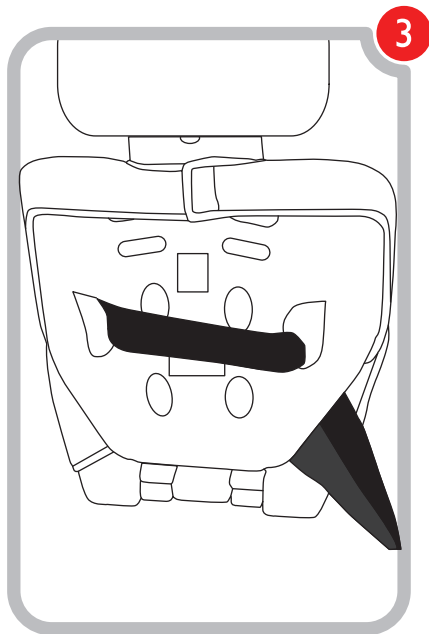

# EST-123 Car Seat

**GROUP**

**1**

**(9 - 18kgs)**

4. Hook the seatbelt under the parallel 'arm' of the booster seat, and click the seat belt in place.

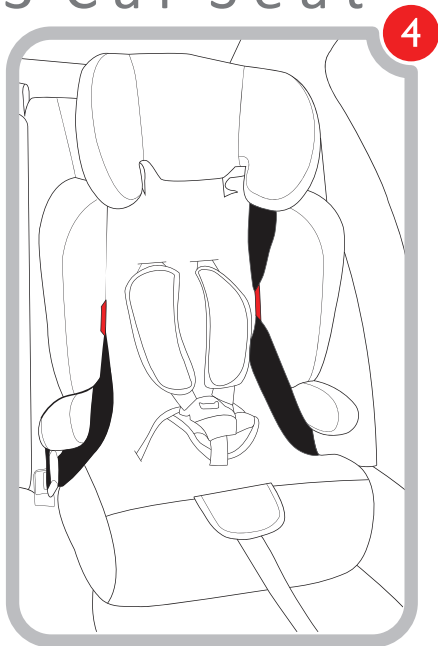

**C | S**  
— COZY N SAFE —

# EST-123 Car Seat

**GROUP**

**1**

**(9 - 18kgs)**

5. Ensure that the seatbelt is not twisted.

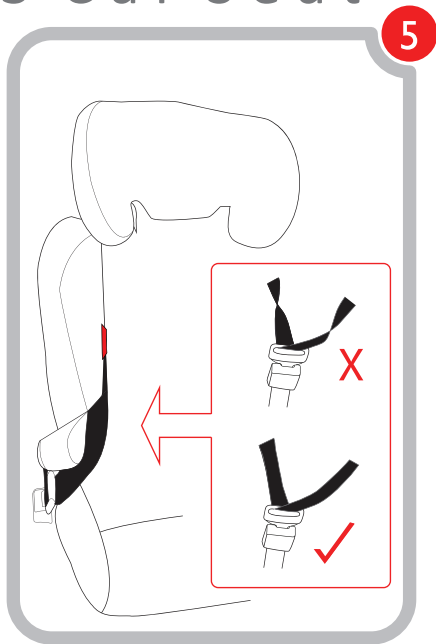

**C | S**  
— COZY N SAFE —

# EST-123 Car Seat

**GROUP**

**1**

**(9 - 18kgs)**

6. Tighten the vehicle seatbelt in the direction of the red arrows until the car seat is secure.

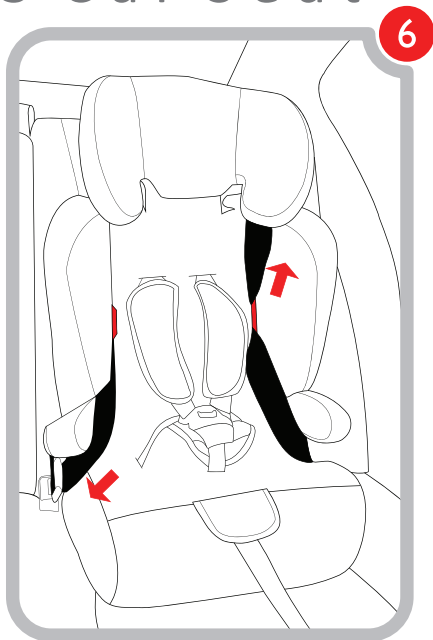

**C | S**  
— COZY N SAFE —

# GROUP 2



# EST-123 Car Seat

GROUP

2

(15 - 25kgs)

1. When your child is between 15-25kgs, and ready for Group 2, remove the harness altogether.

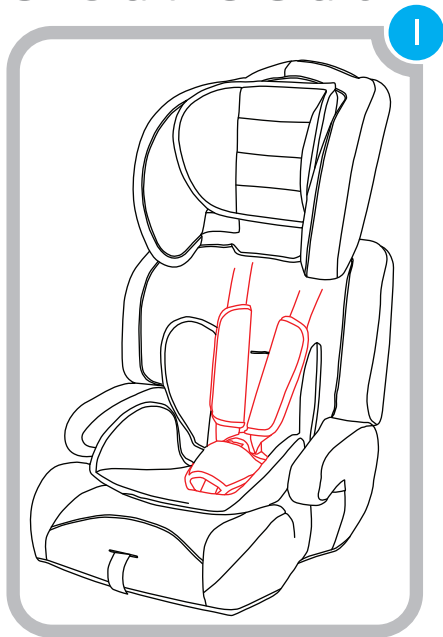

# EST-123 Car Seat

GROUP

2

(15 - 25kgs)

2. Thread the car's 3 point lap belt under both armrests and over the lap of your child, and position the diagonal belt through the hook beneath the headrest and insert the belt into the buckle as normal. It is very important that the seatbelt is threaded correctly through the headrest.

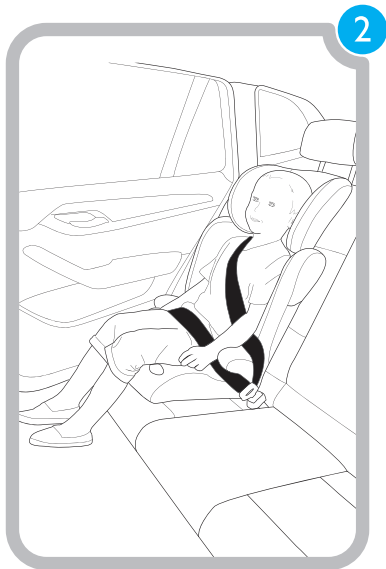

# EST-123 Car Seat

GROUP

2

(15 - 25kgs)

3. Ensure that the car seat is secure. Make sure that the seatbelt is not twisted.

4. The headrest is adjustable and should be adjusted as your child grows. To adjust the height hold the headrest and push the triangular button located on the back of the headrest with your other hand. You can then position the head rest to a suitable height. The top of the headrest must never be below the eye-line of your child.

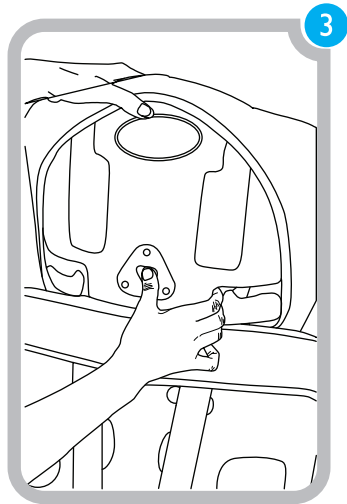

# GROUP 3

# EST-123 Car Seat

**GROUP**

**3**

(22-36kgs)



**C | S**  
— COZY N SAFE —

# EST-123 Car Seat



**(22-36kgs)**

1. Ensure that all harnesses and pads have been removed.  
Remove the back cushion by placing the base on a flat surface, and pushing the backrest down until the seat is completely flat. You should then be able to lift the backrest off the booster seat.
2. Place the booster seat onto the rear passenger seat in a forward facing position. Once your child is seated on the cushion, thread the cars safety belt under both armrests and over your childs lap, making sure that the seatbelt is not twisted. Thread the diagonal belt above the armrest, then fix the belt into the buckle as normal.

## CONTACT US:

Should you have any questions about your car seat or experience any difficulties please contact:

Cozy N Safe  
Oxford Street, Wolverhampton,  
West Midlands, WV14 7DP, U.K  
Tel: +44(0)1902494905  
Fax: +44(0)1902490211  
Email: [enq@cozynsafe.com](mailto:enq@cozynsafe.com)

**NOTE:** Please keep this instruction booklet in a secure place for the life period of the child car seat.







Cozy N Safe

Oxford Street, Wolverhampton,  
West Midlands, WV14 7DP, U.K.

Tel: +44 (0) 1902 494905

Fax: +44 (0) 1902 490211

Email: [enq@cozynsafe.com](mailto:enq@cozynsafe.com)