

● 40cm-150cm

C O Z Y **N** S A F E[®]
Without Compromise...

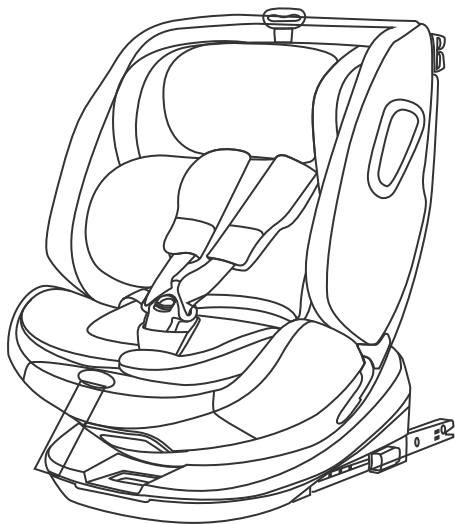

ETNA i-Size

EST - 839

Instruction Manual

CHILD INFORMATION
(KEEP WITH CAR SEAT AT ALL TIMES IN CASE OF EMERGENCY)

NAME:

.....

DATE OF BIRTH (DD/MM/YYYY):

.....

ADDRESS:

.....

.....

.....

ALLERGIES/MEDICAL CONDITIONS:

.....

.....

.....

EMERGENCY CONTACT 1:

NAME:

.....

PHONE NUMBER:

.....

EMERGENCY CONTACT 2:

NAME:

.....

PHONE NUMBER:

.....

USER'S MANUAL

We are honored that our child safety seat can accompany your child safely through a new stage of life. To ensure your child's safety, please install and use this child safety seat correctly as described in this manual. Please feel free to contact us if you have any questions about use.

Content

1.Warningt	2
2.Components overview	4
3.Precautions for vehicle use	5
4.Child car seat installation	7
4-1Rearward facing 40-105cm	7
4-2Forward facing 76-105cm	10
4-3Forward facing 100-150cm ISOFIX + Adult safety belt	13
4-4 Forward facing 100-150cm Adult safety belt only	15
4-5Self 5 point seat belt fixation and removal	18
4-6Removal of ISOFIX and top tether	19
5.Adjustment of child car seat	19
5-1Adjust 5-point harness	20
5-2Adjust car seat angle	22
5-3Adjust headrest height	23
5-4Adjust buckle	23
5-5Use of cushion	23
6.Remove/Install car seat cover	24
7.Car seat Preservation	25
8.Matters need attention	

Safety instructions

1. Please read this manual carefully, otherwise improper installation will lead to serious injury. In this case, the manufacturer will not be held liable
2. This ECRS is suitable for children of 40–150cm height.
3. For use with Vehicle seat belts, only apply if the applicable model is equipped with 3–point belt with retractor as required by ECE R129
4. (a) Child restraint systems shall not be used without Seat covers.
(b) System coverings shall not be made of materials other than those recommended by the manufacturer, which affect the overall integrity of the child restraint system
5. If the surface covering of the child restraint system is not a fabric, it should be prompted to keep out of the sun, otherwise the seat surface can burn the child.
6. Restraint system should be replaced after accident.
7. Luggage and articles that may cause injury in a collision should be properly placed.
8. Ensure that the seat belt latch is locked properly and that the child can be quickly released in case of an emergency.
9. The rigid and plastic parts of the child restraint system should be properly placed and installed so that during normal use of the vehicle, the child restraint system does not get stuck by the movable seats or doors in the car.
10. Secure the child restraint system properly even if no child is sitting on it.
11. Children's restraint system should be kept away from corrosive objects.
12. Each webbing connected to the vehicle in the child restraint system should be tied tightly. The webbing used to restrain the child should be adjusted according to the child's body, and the webbing should not be twisted.
13. The instructions can be clearly seen during the service life cycle (please store the instructions in the seat for special storage after use).
14. The manufacturer guarantees the quality of the products, except second-hand products.
15. If you have any questions about the use and installation of child seats, please contact our service hotline.

Warning:

1. As an important part of the child restraint system to protect the safety of children, the belt should ensure that it can well restrain the pelvic region when worn (see the installation instructions on the following page).
2. For ISOFIX type child restraint systems, the user must read the description of ISOFIX fixing points in the automobile manufacturer's manual
3. Uncertified products and modified products are dangerous, and there are no installation instructions provided by the manufacturer nearby is also dangerous.
4. Do not use any stress points other than those described in the documentation and identified on the child restraint system.
5. Do not leave children unattended in a child restraint system.
6. Under no circumstances should a child restraint system be used in a car seat with airbag enabled.
7. Children sometimes carry objects (such as toys) in their clothes or trouser pockets, or wear hard objects (such as buckles). Make sure these objects do not get between the child and the seat belt, as they may cause unnecessary injury in an accident. This can happen to adult as well.
8. Children are naturally active, so you should patiently explain the importance of using a child restraint system. You must make it clear to your child that the seat belt should not be touched or the buckle should not be opened.
9. The seat must be as close to/against the back of the vehicle seat as possible.

Size	facing	installation method	category
40-105cm	rearward	ISOFIX +Top tether	i-Size
76-105cm	forward	ISOFIX +Top tether	i-Size
100-150cm	forward	ISOFIX + Adult safety belt	i-Size booster seat
100-150cm	forward	Adult safety belt only	i-Size booster seat

2. Components of safety seat:

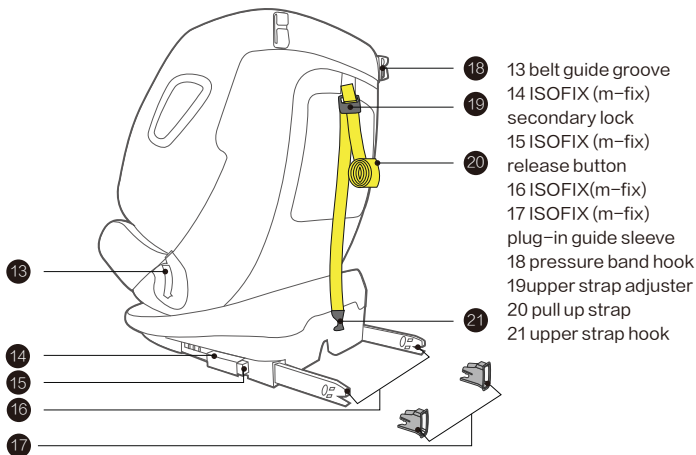
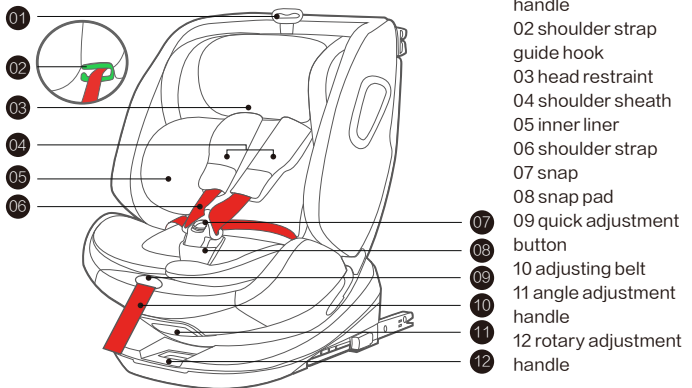

3. Precautions for vehicle use



Warning: under no circumstances should the child restraint system be used on the car seat with airbag enabled.

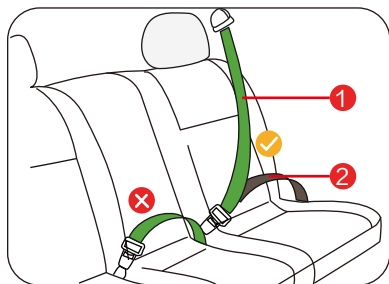

- ✓ correct installation /Applicable
- ✗ Wrong installation/Not Applicable
- 1 Vehicle seat belt –Shoulder belt
- 2 Vehicle seat belt–Lap Belt

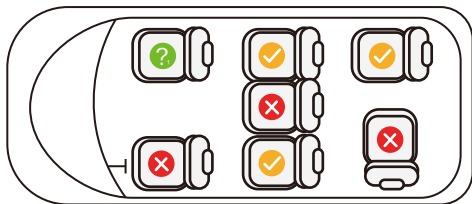

- ✓ Allowed to Install
- ? The seat may not be installed in the area of effect of an airbag
- ✗ Not allowed to Install

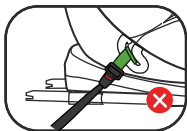
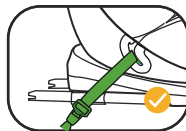

The picture shows the incorrect position of the buckle of the adult seat belt relative to the main stress point of the child restraint system. If users have any questions about this, they are advised to contact the manufacturer of the child restraint system.

3. Precautions for vehicle use

Before using ISOFIX and TT straps, check whether the car seat is equipped with ISOFIX fixed anchor points and whether the size category matches. The car seat is equipped with ISOFIX fixed anchor points and ISOFIX size category match before using.

Top tether
Vehicle up
anchor point

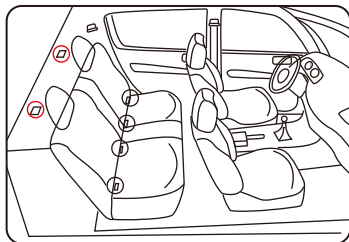

ISOFIX
Vehicle below
anchor point



First read the car instructions and check whether the car seat is equipped with ISOFIX fixed anchor points and their recommended ISOFIX constraints
System match or ISOFIX size and type or not

4. Baby car seat installation

4-1 Rearward facing 40-105cm

ISOFIX + Top tether + Harness



About
Birth- 3 years

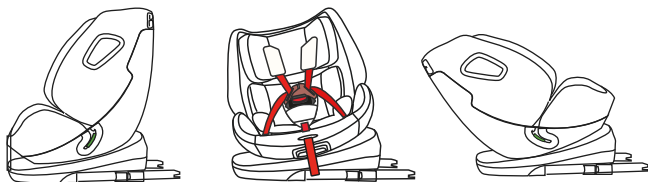

1. Hold the Angle and rotate the adjusting handle 11, then rotate the seat to the car's Rear, the child seat is in reverse mode, facing back.
2. Pull the seat Angle and rotate the adjusting handle 11 to adjust the seat to Max.inclined position.



Notice

1. When the child seat is installed Rearwards: it has only one gear that can be adjusted.
2. The child seat can be rotated directly when it is in the forward/rearward position.



ISOFIX install in the vehecile seat

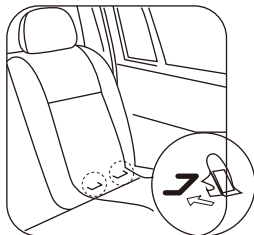

1. If your car is not equipped with ISOFIX plug-in guide sleeve 19, please use the two ISOFIX plug-in guide sleeve 19 equipped with this seat to clip the ISOFIX fixed point J of the car with the notch facing upwards (as shown in the picture).

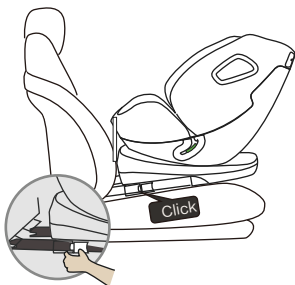
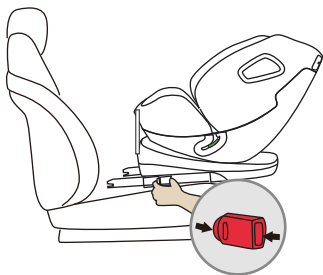

2. Hold down ISOFIX lock button 16 and ISOFIX lock release button 17, and pull ISOFIX18 to the end position
3. The left and right ISOFIX18 buckle to the ISOFIX fixed point J of the car, hear the "click" sound, ISOFIX left and right sides, It shows "green", which means it is closed.
4. Push the seat inward so that the back of the child seat is against the back of the car

Reminder

1. Before a child uses a child safety seat, ensure that the ISOFIX Settings on the left and right are consistent

5. Shake the child seat to ensure ISOFIX18 is securely fixed

Top Tether installation



1. Untie the top bristle K, and then press the button to adjust the top Tether 14 to adjust the top tether 13.

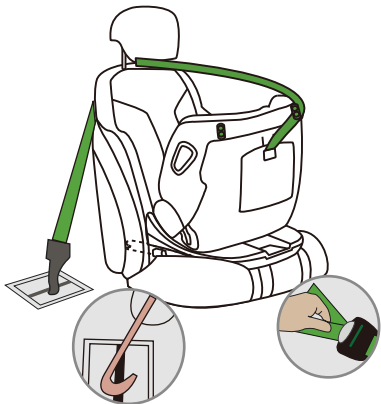

2. Pull Top Tether 13 through car headrest.
3. Hook the top tether hook 15 to the fixed point of the car seat according to the car manual, and tighten the top tether 13 (when it is tightened, the button will display "green")
4. Place the child in the car seat and use the five-point fixed (5 point belt refer to 4-4)

! Reminder

Never use a luggage hook instead of a top tether strap, Check your car for signs like this:



! Reminder

1. The child restraint system cannot be installed in the effect of airbag
2. Do not use forward facing before the child's age exceeds 15 months

! Notice

1. The 5-point seat belt should not be twisted or wound to ensure that the child is firmly secured.
2. When the top tether is tightened, the adjust button of it is displayed in green.
3. The Top tether must pass through the top tether guide.
4. The seat must be as close to (against) the back of the vehicle seat as possible.

4-2 Forward facing 76-105cm

About 18 months
to 3 years

ISOFIX+ Top tether+ Harness

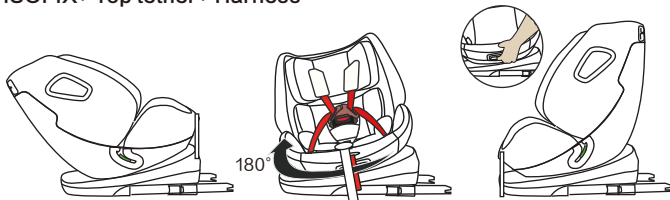

1. Hold the Angle and rotate the adjusting handle 11, then rotate the seat to the car's Forward, the child seat is in forward mode, facing forward.
2. Pull the seat Angle and rotate the adjusting handle 11 to adjust the seat to Most suitable position, total 5 gears . (Adjustable back and forth to the most suitable Angle)

Notice

1. When the child seat is installed in the forward direction: the child seat has 5 gears to adjust.
2. The child seat can be rotated directly when it is in the forward/rearward position.



ISOFIX Installed in the car seat

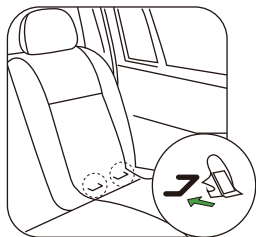

1. If your car does not come standard with ISOFIX plug-in guide sleeve 19, please use This seat equipped two ISOFIX plug-in guide sleeves 19 clipped on the car On the ISOFIX fixed point J, the notch faces upward (as shown in the pic).

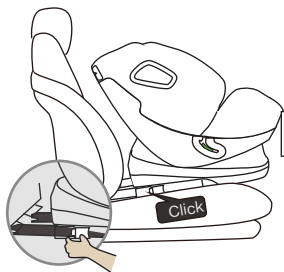
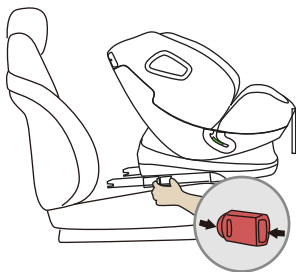

- 2 Hold down ISOFIX double lock button 16 and ISOFIX release button 17 at the same time, and pull ISOFIX18 backward to the final position.
3. The left and right ISOFIX18 buckle to the ISOFIX fixed point J of the car, hear the "click" sound, ISOFIX on both sides, If it shows "green", it means it is closed.
4. Push the seat inward so that the back of the child seat is against the back of the car.

⚠ Reminder

1. Child in front of a car seat. Ensure that both sides ISOFIX taps are consistent.

5. Shake the child seat to ensure ISOFIX18 is securely fixed.

Top Tether installation



1. Untie the top bristle K, and then press the button 14 to adjust the top tether 13

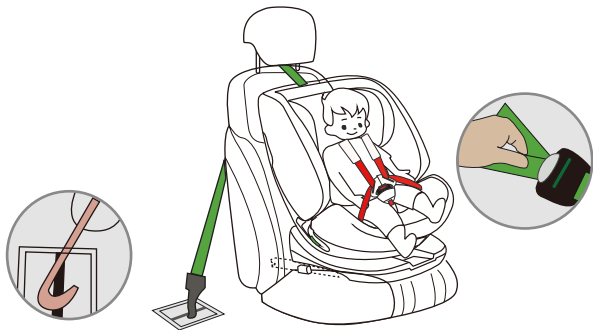

2. Pull belt 13 through car headrest.

3. Hook the top tether hook 15 to the fixed point of the car seat according to the car manual, and tighten the top tether 13 (when the pull-up belt adjust button 14 show "green")

4. Place the child in the car seat and secure the child with a 5-point seat belt (see 4-4 for 5-point seat belt fixation).

! Reminder

Never use a luggage hook instead of a top tether strap, Check your car for signs like this:



! Notice

1. The 5-point seat belt should not be twisted or wound to ensure that the child is firmly secured.
2. When the top tether is tightened, the adjust button of it is displayed in green.
3. The top tether must pass under the headrest of the vehicle seat.
4. The seat must be as close to (against) the back of the vehicle seat as possible.

4-3 Forward facing 100-150cm

About
3-12 years

ISOFIX +Adult safety belt

Hide your own 5-point safety belt when using vehicle safety belt (see 4-4 for details)

Angle adjustment



Pull the Angle of the seat and rotate the adjusting handle 11 to adjust the seat to the upright position.

ISOFIX into car seat

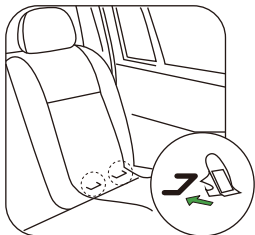

1. If your car is not equipped with the standard ISOFIX plug-in guide sleeve 19, please use the two ISOFIX plug-in guide sleeve 19 equipped with this seat to clip the ISOFIX fixed point J of the car with the cut facing upwards (as shown in the picture).

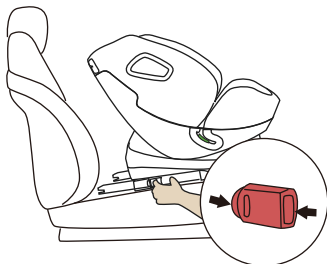

2. Hold ISOFIX double lock button 16 and ISOFIX release lock button 17 at the same time, and pull ISOFIX 18 to the end.

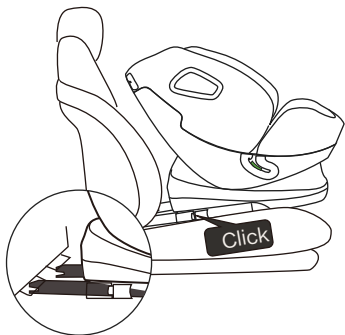

3. Buckle both sides M-FIT18 to the ISOFIX fixed point J of the car, hear the sound of "click", the both sides of ISOFIX above the display of "green", indicating that the buckle.
4. Push the seat inward so that the back of the child seat is against the back of the car.



Notice

Ensure that the left and right ISOFIX gears are the same before your child is in the car seat.

5. Shake the child seat to ensure ISOFIX 18 is securely fixed

Vehicle seat belt fix the child car seat

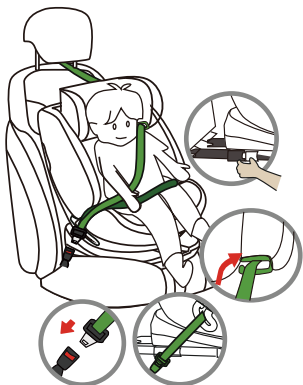

1. Place the child in the child car seat
2. Pass the Vehicle seat belt S through the strap guide hook and around the child's shoulder.
3. The car cut the belt belt T through the lap belt guide¹², and around the child's pelvis.
4. The shoulder belt S and the belly side T pass through the plate belt on the other side at the same time, leading to the 12 well buckle the safety belt.

! Notice

1. Check and tighten the vehicle shoulder belt and lap belt to ensure that the seat and children are firmly fixed.
2. The shoulder strap and lap belt of the vehicle safety belt should not be twisted or wound.
3. The seat must be as close to (against) the back of the vehicle seat as possible.

4-4 Forward facing 100–150cm Adult safety belt only

Hide your own 5-point safety belt when using vehicle safety belt (see 4-4 for details)

Angle adjustment



Pull the Angle of the seat and rotate the adjusting handle 11 to adjust the seat to the upright position.

Vehicle seat belt fix the child car seat

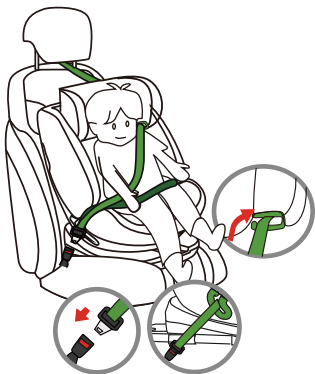

1. Place the child in the child car seat
2. Pass the Vehicle seat belt S through the strap guide hook and around the child's shoulder.
3. The car cut the belt belt T through the lap belt guide¹², and around the child's pelvis.
4. The shoulder belt S and the belly side T pass through the plate belt on the other side at the same time, leading to the 12 well buckle the safety belt.

⚠ Notice

1. Check and tighten the vehicle shoulder belt and lap belt to ensure that the seat and children are firmly fixed.
2. The shoulder strap and lap belt of the vehicle safety belt should not be twisted or wound.
3. The seat must be as close to (against) the back of the vehicle seat as possible.

4-5 Remove ISOFIX and top tether

ISOFIX removing car seat

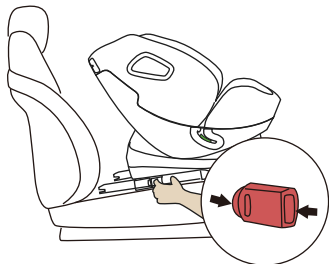

Press ISOFIX release button 17 and ISOFIX double lock button 16 at the same time and hear the "click" to remove ISOFIX18 from the car seat.

Top Tether dismount

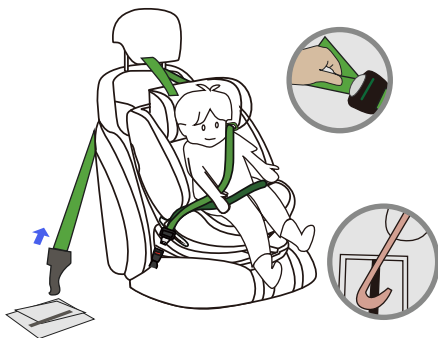

Press the adjustable button 14 of top tether first to loosen the top tether 13, and then remove the pull-up belt 15 from the fixed pot point of the car, and move the top tether back

5. Adjustment of child car seat

5-1 5 point belt adjustment

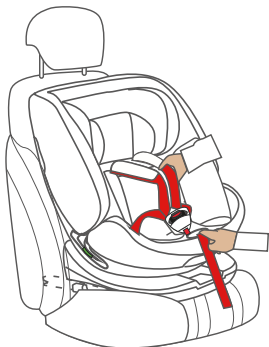

Loosen: press the quick regulator button 9 at the front with one hand, grab the two shoulder straps 6 with one hand (do not pull shoulder jacket 4), and pull them towards the front of the seat.



Tighten: hold the adjusting belt 10 and slowly pull it forward. When two adult fingers can be accommodated between the shoulder strap protector 4 and the child, release the adjusting belt. At this time, the tightness of the shoulder belt is the most suitable.



! reminder

When the shoulder strap passes through the seat strap hole, it should be parallel to or slightly higher than your child's shoulder height.

5-2 car seat recline angle adjustment

reverse angle adjustment



1. Grasp the Angle and rotation adjustment handle 11, and then rotate the seat to the rear of the car, so that the child car seat is in rearward mode, facing backward.
2. Pull the Angle of the seat and rotate the adjusting handle 11 to adjust the seat to the max.inclined positlon.

Notice

1. When the child seat is installed rearwards: the child seat has one gear that can be adjusted.
2. The child seat can be rotated directly when it is in the forward/rearward position.

Reverse angle adjustment

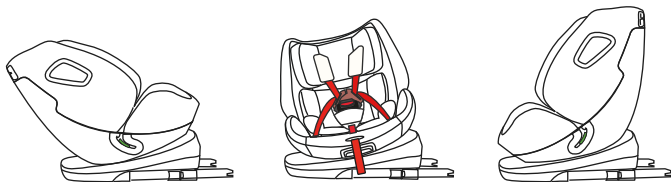

1. Grasp the Angle and rotation adjustment handle 11, and then rotate the seat to the front of the car, so that the child safety seat is in forward mode, facing forward.
2. Pull the Angle of the seat and rotate the adjusting handle 11 to adjust the seat to the most appropriate position. There are 5 gears in total. (Adjustable back and forth to the most suitable Angle)

! Notice

1. Forward facing 76–105cm: position 1–5 Forward facing 100–150cm: position 1
2. The child seat can be rotated directly when it is in the forward/readward position.

seat 90 degree rotation adjustment

Grasp the Angle and rotate the handle 11, then rotate the seat to 90° for the child to enter.

! Notice

When the seat rotates to 90°, It is easier for child to leave the car seat



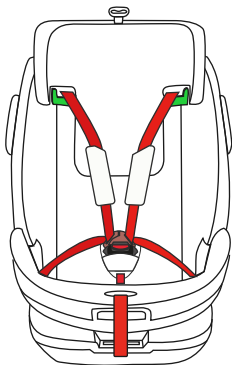

Up: pull the head pillow at the top of the seat to adjust the handle 2 and lift up.

Down: one hand hold the head pillow at the top of the seat to adjust handle 2, lift up, one hand hold the head pillow 1, press down, you can lower the head pillow.

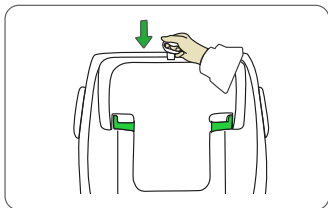
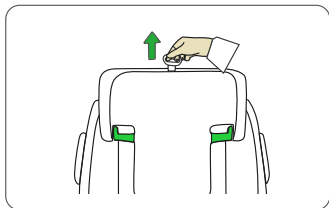

Reminder

The headrest of the child seat can be adjusted to the highest level only when both shoulder jacket straps C are inserted into the headrest strap hole K.

5-4 Buckle adjustment

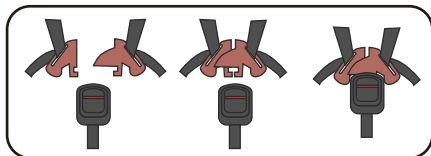

! Reminder
Press the red button
on the buckle to
release it

Insert the left and right buckle inserts B together into buckle 7. "click" sound is heard, indicating that the buckle is fastened.

5-5 use of cushion

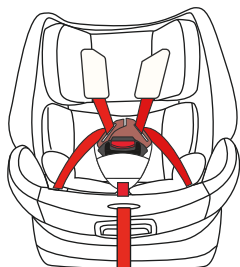

Cushion is suitable for children of
40-75cm height.

! Reminder

It will make your child safer and more comfortable by using cushion 5

6. seat cover disassemble and assemble

Removal of cloth sleeve

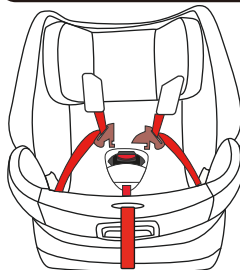

1. Loosen five-point seat belt (see 4-4)
2. Loosen buckle 7, take out inner liner 5, and remove shoulder pad
Set 4 and buckle pad 8 (see 4-4).
3. Remove the seat cover from back to front.
4. Remove the head pillow cover.



7. Cleaning and maintenance

Important note:

Seat Fabric cover is an important part of car child car seat , do not use the car without seat fabric cover also do not use other products to replace the original seat cover, this will put the child in danger Risks. Because other products can not protect the child as the original one

Washing instructions:

seat cover cleaning: removable, can be washed in water temperature below 30 degrees, can only be dried.

Cleaning of plastic parts: Plastic parts can be cleaned with mild detergent or wet towel, do not use corrosive clear

Cleaning agent (e.g. solvent).

Safety belt system cleaning: Safety belt system can be cleaned with wet towel, do not use detergent

8.Matters need attention

EST-839 40-150cm About 0-12years

NOTICE

regarding i-Size category Enhanced Child Restraint Systems (40-105cm)

This is an i-Size Enhanced Child Restraint System.

It is approved according to UN Regulation No. 129, for use in, i-Size compatible vehicle seating positions as indicated by vehicle manufacturers in the vehicle users' manual.

NOTICE

regarding i-Size booster seat category Enhanced Child Restraint Systems (100-150cm)

This is a i-Size booster seat Enhanced Child Restraint System.

It is approved according to UN Regulation No. 129, for use primarily in "i-Size seating positions" as indicated by vehicle manufacturers in the vehicle user's manual.