

CHILD INFORMATION  
(KEEP WITH CAR SEAT AT ALL TIMES IN CASE OF EMERGENCY)  
NAME:  
.....

DATE OF BIRTH (DD/MM/YYYY):  
.....

ADDRESS:  
.....  
.....  
.....

ALLERGIES/MEDICAL CONDITIONS:  
.....  
.....  
.....

EMERGENCY CONTACT 1:

NAME:  
.....

PHONE NUMBER:  
.....

EMERGENCY CONTACT 2:

NAME:  
.....

PHONE NUMBER:  
.....

● 40cm-87cm

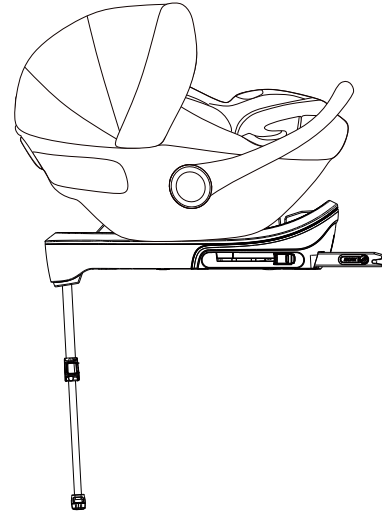

ODESSEY i-Size+BASE

EST - 33+BASE  
Instruction Manual

<b>Contents</b> .....	<b>1</b>
<b>Warning</b> .....	<b>2-3</b>
<b>Know your infant carrier</b> .....	<b>4-6</b>
<b>1. Certification</b> .....	<b>6</b>
<b>2. Use in the vehicle</b> .....	<b>7-8</b>
<b>3. Securing you baby</b> .....	<b>9-13</b>
3.1 Securing your baby using the baby insert .....	9
3.2 Adjusting the handle .....	10
3.3 Adjusting the headrest .....	11
3.4 Loosening the shoulder straps .....	11
3.5 Securing your baby using the harness .....	12
3.6 Tightening the harness .....	13
3.7 Checklist to ensure that your baby is buckle up correctly .....	13
<b>4. Installation in the vehicle</b> .....	<b>14</b>
4.1 Installation in the vehicle .....	14
4.2 Installation instruction for STATURE 40-87cm, Rearward facing ISOFIX+support leg+harness.....	15-17
<b>5. Fitting the sunshade</b> .....	<b>17</b>
<b>6. Care instructions</b> .....	<b>18-22</b>
6.1 Care instructions.....	18
6.2 Care for the harness buckle.....	18
6.3 Method of cleaning fabric cover .....	19
6.4 Re-fitting the cover .....	20
6.5 Cleaning .....	21
6.5 Year warranty.....	21-22

1. The rigid items and plastic parts of an Enhanced Child Restraint System shall be so located and installed that they are not liable, during everyday use of the vehicle, to become trapped by a movable seat or in a door of the vehicle.
2. Do use carry-cots perpendicular to the longitudinal axis of the vehicle.
3. Any straps holding the restraint to the vehicle should be tight, any support-leg should be in contact with the vehicle floor, any straps or impact shields restraining the child should be adjusted to the child's body, and straps should not be twisted.
4. It is important to ensure that any lap strap is worn low down.
5. The Enhanced Child Restraint System should be replaced when it has been subject to violent stresses in an accident.
6. It is danger to make any alterations or additions to the device without the approval of the Type Approval Authority, and it is also danger not following closely the installation instructions provided by the Enhanced Child Restraint System manufacturer

## Warning

7. Be sure that children are not left in their ECRS unattended.
8. Be sure that any luggage or other objects liable to cause injuries in the event of a collision shall be properly secured.
9. Be sure that the Enhanced Child Restraint System shall not be used without the cover.
10. Be sure that the Enhanced Child Restraint System cover should not be replaced with any other than the one recommended by the manufacturer, because the cover constitutes an integral part of the restraint performance.
11. Be referred to the vehicle manufacturer's handbook for the use of an "i-Size ECRS".

## Know your infant carrier

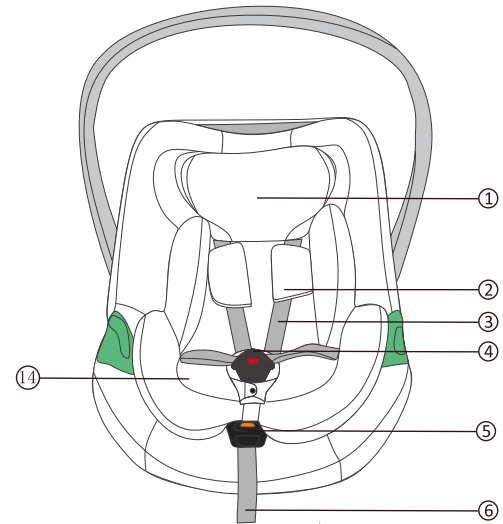

1. Headrest
2. Shoulder pad
3. Shoulder strap
4. Harness buckle
5. Harness release button
6. Harness strap
14. baby insert

## Know your infant carrier

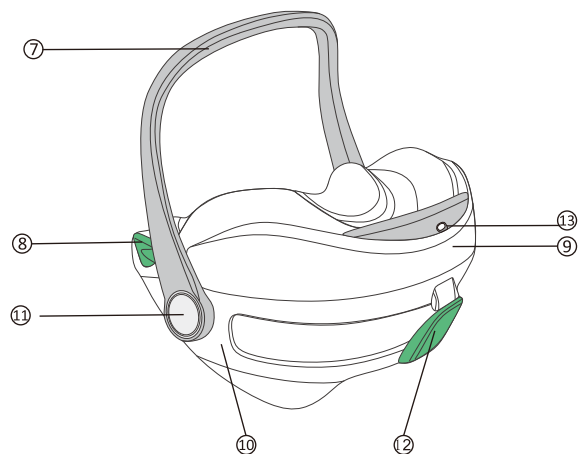

- 7. Handle
- 8. Lap belt guide
- 9. Shade shed shaft
- 10. Seat shell
- 11. Handle adjustor
- 12. Diagonal belt guide
- 13. Headrest adjuster

## Know your infant carrier

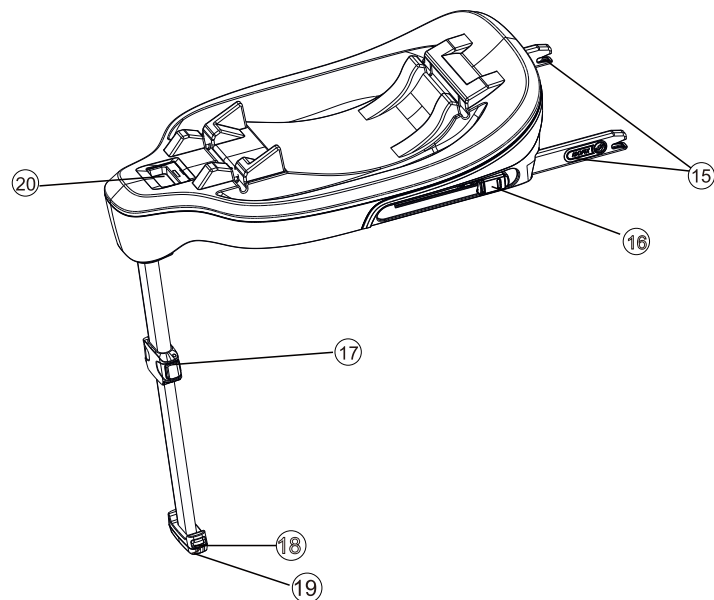

- 15. ISOFIX connector
- 16. ISOFIX Release button
- 17. Support leg adjusting button
- 18. Support leg block
- 19. Support leg indicator
- 20. Base unlocking handle

## 1. Certification



... as a child safety seat installed in a vehicle

EST-33 Base Child Safety Seat	Tested and certified according to ECE*R129	
	applicable size range	Body Weight
EST-33	height from 40cm to 87cm	Up to 13kg

\*ECE = European Standard for Safety Equipment

The child safety seat has been designed, tested and certified according to the requirements of the European Standard for Child Safety Equipment (ECE R 129).

The seal of approval E (in a circle) and the approval number are located on the approval label (sticker on the child safety seat).

This approval will be invalidated if you make any modifications to the child safety seat. Only the manufacturer is permitted to make modifications to the child safety seat.

## 2. Use in the vehicle

### WARNING

 Never use this child restraint system in seating positions where an active airbag is installed. An active frontal airbag may cause death or seriously injury of your child in an accident. Please read the instructions carefully and keep safely for future reference. There is an instructions compartment in the back of the child car seat for storage of the instructions manual.



You can use your child car seat as follows:

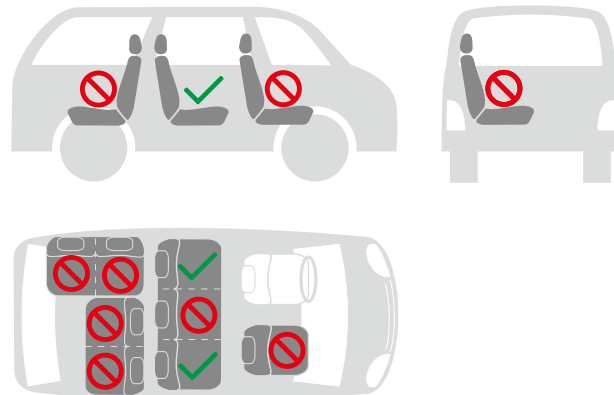

## 3. Securing you baby

### 3.1 Securing your baby using the baby insert



#### For the protection of your baby

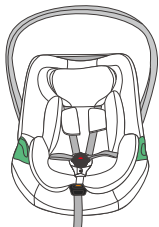

The baby insert gives your baby the necessary support while he or she is still small.

The baby insert is used to provide extra comfort for very small babies.

**Caution!** Please use the baby insert attached to this infant carrier when your baby's height is less than 75cm

- Always secure your baby in the infant carrier using the harness.
- Never leave your baby unattended in the infant carrier when placing it on elevated surfaces (e.g. a table, nappy changing unit, etc.).
- Never allow the strap end to become caught in moving parts (e.g. automatic doors, escalators, etc.).
- **Caution!** The plastic parts of the infant carrier heat up in the sun, so that your baby may get burnt. Protect your baby and the infant carrier against intensive solar radiation (e.g. by putting a light cloth over the seat).
- The infant carrier requires only one seating position in the car. This advantage means, however, that your baby must be in a semi-reclined position.
- Take your baby out of the infant carrier as often as possible to relieve its spine. We recommend frequent breaks during long journeys. Even outside of the car, please avoid leaving your baby in the infant carrier for too long.

## 3.2 Adjusting the handle

You can engage the adjuster in four positions

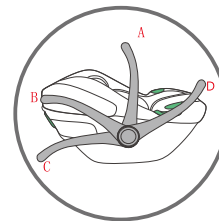
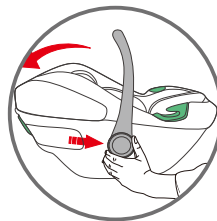

simultaneously press both buttons on the handle.

Then whilst holding the adjuster pressed turn the handle backwards until it engages in the desired position.

**A:** only available for arrying, can not be used when installing on the vehicle seat.

**Caution!** Ensure that the handle is securely engaged before you pick up the infant carrier.

**B:** For placing your baby into the infant carrier.

**Tip!** You can move the handle from one position to another by pushing a button.

**C:** For setting the infant carrier down safety outside the car.

**D:** Available for installation status on the vehicle seat.

### 3.3 Adjusting the headrest

A correctly adjusted headrest ensures your baby's optimal posture in the infant carrier.

The headrest must be adjusted so that the shoulder straps are at the same level as your baby's shoulders or slightly above.

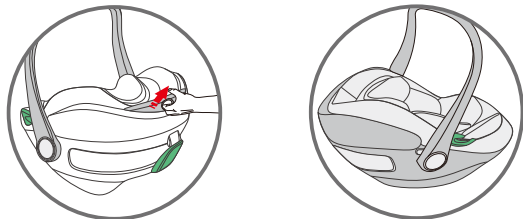

**To adjust the height of the headrest to fit your baby:**

Tilt the headrest adjuster until it disengages.

Slide the headrest adjuster until the shoulder straps are at the correct height and re-engage.

### 3.4 Loosening the shoulder straps

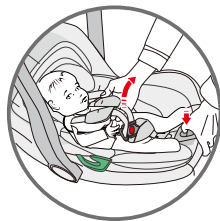

Press the harness release button and at the same time pull both shoulder straps forward.

### 3.5 Securing your baby using the harness

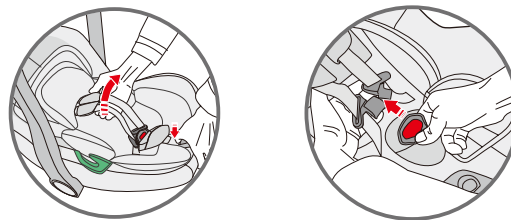

- Loosening the shoulder straps.
- Open the harness buckle (press the red release button).

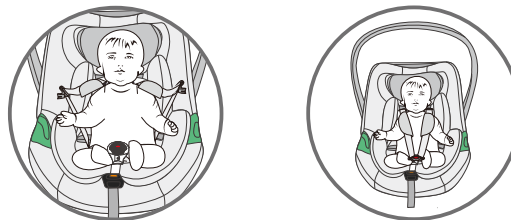

- Place your baby into the infant carrier.
- Put the shoulder straps over the shoulders of your baby, then put the buckle tongues together and engage in the harness buckle with an audible "click".

**Caution!** Do not twist or interchange the shoulder straps.

## 3.6 Tightening the harness



Pull the strap end  
**Caution!** Pull the strap end straight towards you, not upwards or downwards.

Please pay attention to the strap end.  
Whilst travelling (especially outside the car) it should always be attached to the cover.

## 3.7 Checklist to ensure that your baby is buckle up correctly.

 **For the safety of your baby ,please check that...**

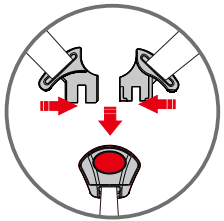

- The shoulder straps of the infant carrier are comfortable but FIRM fit around your child.
- The shoulder straps are adjusted correctly.
- The shoulder straps are not twisted.
- The buckle tongues are engaged in the harness buckle.

## 4.1 Installation in the vehicle



**Please do not leave your child unattended in the child safety seat in the vehicle.**



**For the protection of all vehicle occupants**

In the case of an emergency stop or an accident unsecured persons or objects may cause injury to other vehicle occupants. Please always check that...

- The backrests of the vehicle seats are locked (i.e.that a foldable rear seat bench latch is engaged).
- All heavy or sharp-edged objects in the vehicle(e.g. on the parcel shelf) are secured.
- All persons in the vehicle have their seat belts fastened.
- The child safety seat is always secured when it is in the vehicle, even if no child is being transported.

### To protect your vehicle

Some vehicle seat covers of sensitive materials(e.g. velour, leather, etc.) may develop wear marks when child seats are used. This can be avoided by placing a blanket or towel under the child seat.



The baby insert is only suitable for infants with height form 40 to 75CM if your child has height more than 75CM,please take out the baby insert

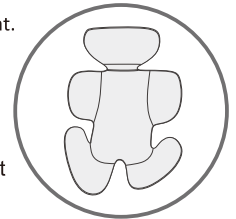



# Installation in the vehicle

## 4.2 Installation instruction for STATURE 40- 87 cm, Rearward facing , ISOFIX + Support Leg + harness.

### 4.2.1 Method one:

First install the base on the seat, then put the infant carrier into the

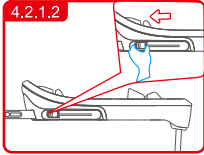
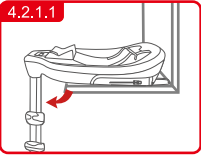

Unfold support leg until it locks in place. Press the ISOFIX release button to slide the ISOFIX connectors to the end.

**Caution:** Please only move to next step when ISOFIX has been slid to the end with appearing the red marks.

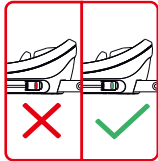
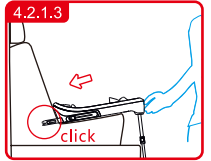
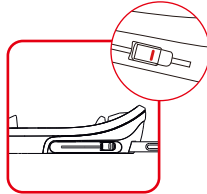

Push the ISOFIX connectors directly into the anchorages until you hear an audible sound "click". Grasp the seat base to check the seat if it is fastened tightly or shakes, meanwhile observe the ISOFIX red/green indicator. If the seat shakes and the ISOFIX connectors are pulled out ,please repeat the above steps and install it again.

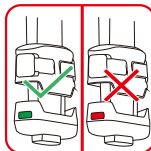
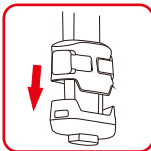

Squeeze the support leg adjusting button, pull out the support leg until it rests firmly on the floor. Observe the ISOFIX red/green indicator to confirm the installation status.

# Installation in the vehicle

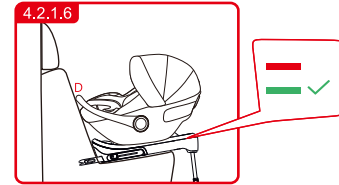
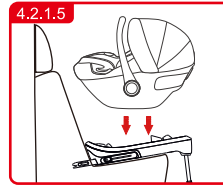

Put the infant carrier into the base. And ensure that the handle is in its upper position D.

### 4.2.2 Method two:

First install infant carrier into the base, and then install both on the seat.

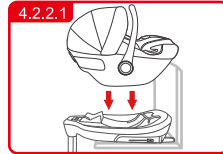

Put the infant carrier into the base.

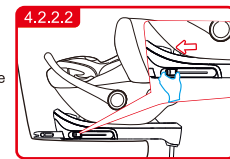

Unfold support leg until it locks in place. Press the ISOFIX release button to slide the ISOFIX connectors to the end.

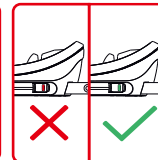

Push the ISOFIX connectors directly into the anchorages until you hear an audible sound "click". Grasp the seat base to check the seat if it is fastened tightly or shakes, meanwhile observe the ISOFIX red/green indicator. If the seat shakes and the ISOFIX connectors are pulled out ,please repeat the above steps and install it again.

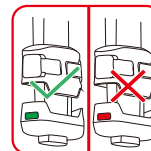
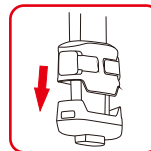

Squeeze the support leg adjusting button, pull out the support leg until it rests firmly on the floor. Observe the ISOFIX red/green indicator to confirm the installation status.

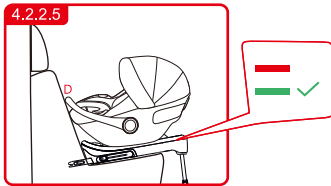

Ensure that the handle is in its upper position D.

### 5.pull the head plate to expand/Fold the canopy.

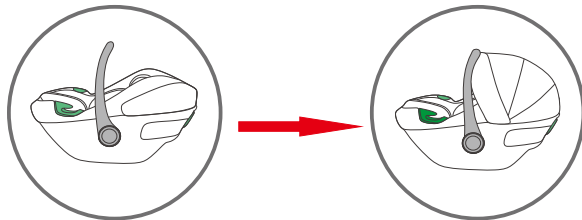

### 6.1 Care instructions



To retain the protective effect

- In an accident at a collision speed above 10 km/h the child safety seat could suffer damage which is not necessarily obvious.
- In such cases it is extremely important that you replace the child seat. Please dispose of it properly.
- Regularly check all important parts for damage.
- Ensure the correct operation of all mechanical components.
- To prevent damage or breakage, ensure that the child seat does not become jammed in the car door, seat runners, etc.
- Should the child seat be damaged (for example after dropping it) it must be inspected by the manufacturer.

### 6.2 Care for the harness buckle

The function of the harness buckle is important for the safety of your child. Malfunctions of the harness buckle are mostly attributable to accumulations of dirt and dust.

### 6.3 Method of cleaning fabric cover

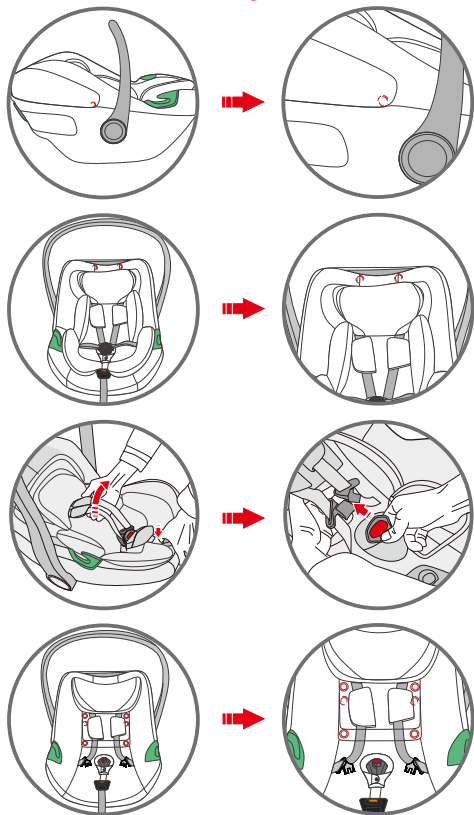

1. Take out the button on the side part of the cover.
2. Take out the button on the main cover.
3. Press the harness release button and at the same time pull both shoulder straps forward
4. Take out the button on the main cover and the should pad
5. Take out the fabric cover and wash it.

### 6.4 Retting the cover

To refit the cover on the seat just hook up the elastic loops to its hook stand, and fit back the headrest cover .

### 6.5 Cleaning

Please be sure to use only original Diadem replacement seat covers, as the seat cover is important to the proper functioning of the system. Replacement seat covers are available from your retailer and/or at branches.

 **The child seat must not be used without the seat cover.**

- The **cover** can be removed and washed with a mild detergent using the washing machine's cycle for delicate items (30°C). Please observe the instructions on the washing label of the cover. The colours of the cover may fade if washed at more than 30°C. Do not spin, and never tumble dry in an electric clothes dryer (the fabric may separate from the padding).
- The **plastic parts** can be cleaned using soapy water. **Do not** use harsh cleaning agents (such as solvents).
- The harness can be removed and washed in lukewarm soapy water.

**Caution!** Never remove the buckle tongues from the straps.

### 6.6 year warranty

For this car/bicycle child seat we provide a 2-year warranty against manufacturing or material defects.

The warranty period is effective from the day of purchase. As proof we ask that you fill out the Warranty Card and retain it for the whole term of the warranty period, together with the Transfer Check signed by you and your sales receipt.

In the case of a warranty claim, the Warranty Card must be returned together with the product. The Warranty covers only car/bicycle child seats which have been handled properly and which have been sent to us in a clean condition.

### The Warranty does not cover:

- Natural signs of wear and damage resulting from excessive stress.
- Damage resulting from inappropriate or improper use.

### What is covered by the Warranty?

**Fabric:** All of our fabrics meet very high requirements with regard to colour fastness when exposed to UV radiation. Nevertheless, all fabrics fade when exposed to UV radiation. This is not a material defect, but rather a normal sign of wear which is not covered by the Warranty.

**Buckle:** Buckle malfunction is often due to accumulations of dirt and dust which may stop it from working properly. If this happens, please firstly check if you can clean by yourself without damaging the installation. If not work, please contact the after-sale service. Please contact your retailer directly in the event of a warranty claim. He or she will give you the advice and support you need. When processing claims, product-specific depreciation rates will be applied. Please refer to our General Terms and Conditions which are available from your retailer.