

gosun[®]
FUSION™

USER'S GUIDE

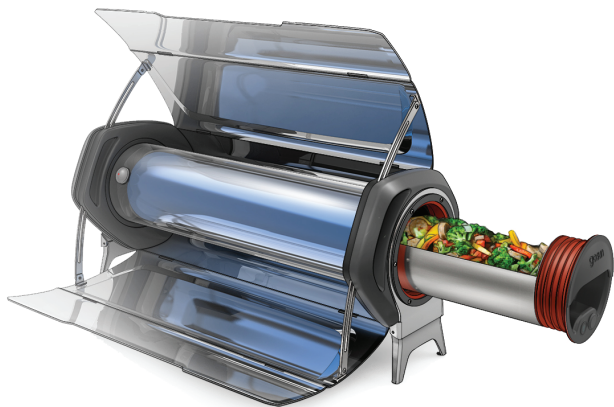

PORTABLE, PRACTICAL, FUEL-FREE
HYBRID COOKER

Manual del usuario en Español / Manuel d'utilisation en Français /
Bedienungsanleitung auf Deutsch / 用⊠手册中文 / 日本語ユーザーズマニュアル
<https://www.gosun.co/pages/product-manuals>

Table of Contents

Important Safety Info	3
General Safety Information	4
Parts List	5
Available Accessories	6

Operating Instructions

Open Stove	7
Orient to Sun	8
The GoSun Dial	9
Insert Food	10-11
Power On	12
Cook Food	13
Cook Times	14
Cooking Tips	15
Cleanup	16
Storage	17

Additional Product Info

Tube Removal	18-19
Maintenance	20
How it Works	21
Product Specifications	22
Liability Release	23
Warranty	24-26
Contact Us	27



DANGER



AVOID THERMAL SHOCK

- Do Not Preheat Stove.
- Do Not Place Cold Food or Water Inside Hot Tube.

CONTENTS HOT

- Handle Stove Contents With Extreme Care.

AVOID OVERHEATING

- Do Not Leave Empty Stove Open and in the Sun

General Safety



• ELECTRICAL SPECIFICATIONS

- Intended for use with power supplies of 12V, 15A (180W)
- Do not put plastic, paper, or non-edible items inside the GoSun Stove.
- This device is not intended for use near or by young children or cognitively impaired persons without supervision.
- Do not attempt to seal or pressurize the Tube.
- Keep Tube free of food debris, grit and sand.
- When removing a broken evacuated Tube, the resulting fragments are very sharp. Use caution and only handle shards wearing the appropriate protective gloves to avoid cuts.
- Fragile: Do not drop the Tube and be sure to protect it from impacts, scratches and other sources of stress.
- Be sure legs are securely in place before loading Tube with Cooking Tray.
- Do not leave device deployed in the sun unattended.
- Do not leave device deployed in the sun without food in the tube/tray.
- Do not leave heating element energized without food in the tube/tray.
- Device not intended for commercial use.
- Clean the Cooking Tray after every use, clean the Tube when needed and only after it has cooled down.
- Use GoSun Stove Implements only with your stove.
- Use caution when pouring hot liquids from tray.
- Do not attempt to heat liquids directly in the tube, always use the provided cooking tray.

Part List

Open:

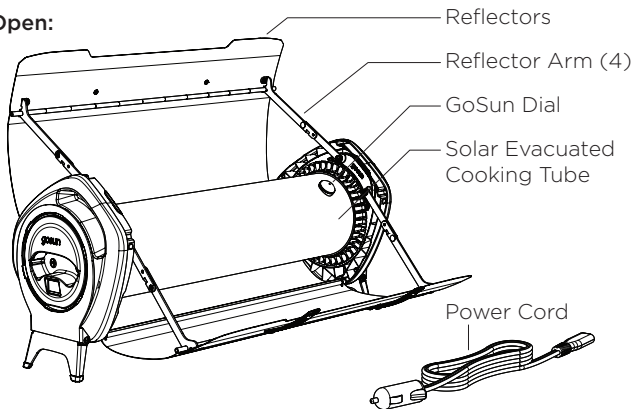

Closed:

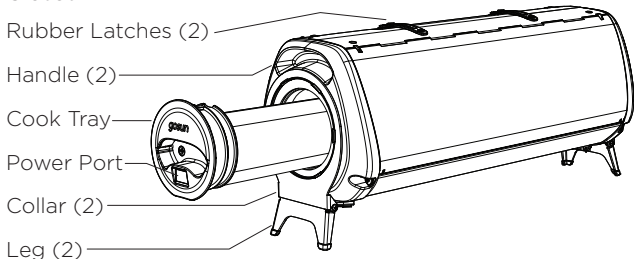

Available Accessories

GoSun PowerBank:

- Lithium-ion Polymer Battery
- Includes AC Adapter for Charging

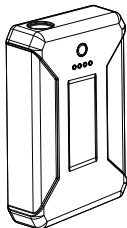

GoSun Thermo:

- Smart, Wireless Thermometer

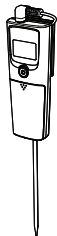

GoSun Solar Panel:

- Fold-able + Durable
- 12V DC Output

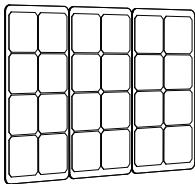

GoSun Fusion Carrying Case

- Ultra portable with handles and shoulder strap



Go to www.gosun.co to learn more

1

OPEN STOVE

1. First Use: Remove from packaging.
2. Slightly lift one end of the Fusion and hinge the corresponding Leg so that it is in the standing position. Repeat on the opposite Leg.
3. Disengage the Rubber Latches located on the top of the unit.
4. Completely open the Reflectors.
5. Pull lightly on the center of all four Reflector Arms to lock them horizontally

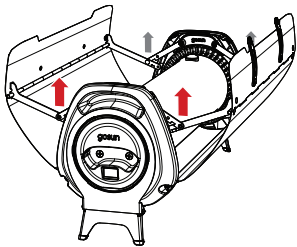
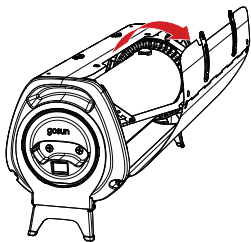
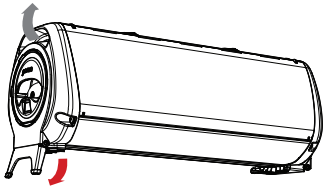

2

COOKING WITH SOLAR

ORIENT TO SUN

1. Firmly grab the Fusion by the Handles on both ends.
2. Rotate the Fusion until the GoSun Dial's shadow and solar glare are directly in the center ring of target below.

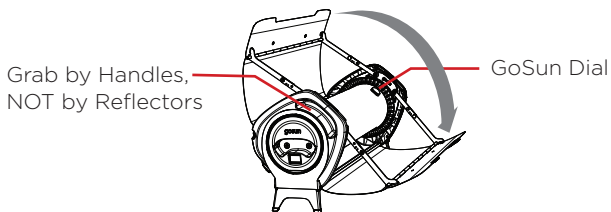

The GoSun Fusion only has to be readjusted every hour or so as the Sun moves through the sky.

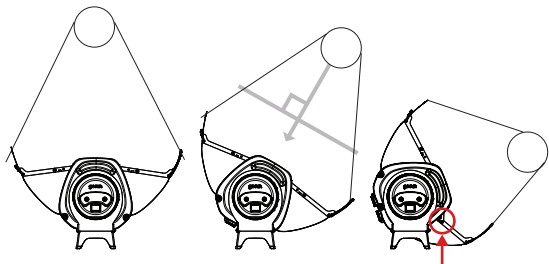

For extreme angles, unlock both lower Reflector Arms

THE GOSUN DIAL

When properly aligned, both the dome's glare and the dot's shadow will be in the center of the target.

OFF-ANGLE:

Glare

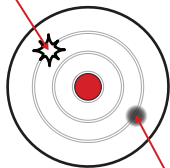

Shadow

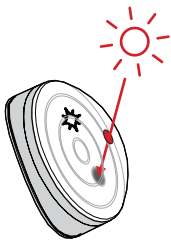

ALIGNED:

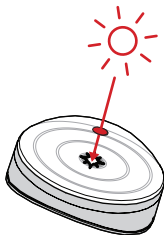
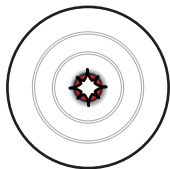

For more information, go to the Accessories page on www.gosun.co.

3

INSERT FOOD

1. Fill up the Cooking Tray with food.
2. Do not allow the cooker to preheat in the Sun or with electricity before placing food inside to avoid thermal shock.
3. Insert cooking tray until Tray Handle seals with the mouth of the Tube.
4. Ensure the Tray remains facing upwards throughout use

NOTE: When handling the Cooking Tray, use both hands to hold the Tray on either end.



WARNING

- **Use oven mitts or other protective materials** when handling the hot Cooking Tray
- **Do not insert cold food into a hot Tube.** It can cause excess stress on the Tube, known as THERMAL SHOCK, which may weaken it or cause it to shatter.
- **Do not overload the Cooking Tray.** Many foods expand when heated and can get stuck inside Tube.
- **Do not force the Cooking Tray in Tube.** It may break the Tube or be difficult to remove.

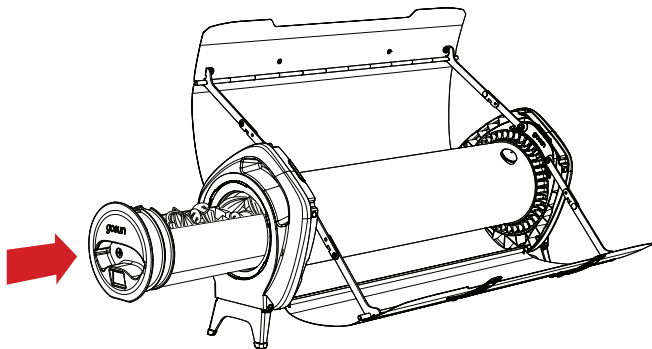
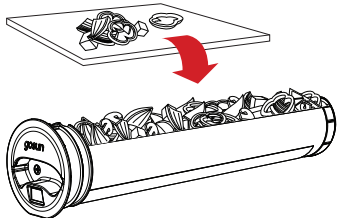

4

COOKING WITH ELECTRIC

POWER ON

1. Locate the Power Cord.
2. Plug the Power Plug into the port on the Cook Tray.
3. Plug the opposite end into any 12V (15 AMP) power source, such as the PowerBank.
4. Activate the switch on the power source end, so that the indicator light turns on.

NOTE: Cooking with both the sun and electricity at the same time is not recommended. Close the reflectors when cooking with electricity.

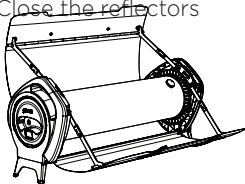

WARNING

- **Integrated Electric Heater will immediately get hot** once plugged in. Handle with protective materials.
- **Intended for use with 12V, 15 AMP power sources.** Check compatibility before plugging in.
- **Do not cook unattended**
- **Do not heat when the cooking tray is empty**
- **Device must be stationary** when cooking

5

COOK FOOD

1. Let the solar-electric hybrid work its magic (see “Cook Times”).
2. To reduce the temperature or slow cooking times, simply pull the device out the Sun’s direct path or close the reflectors.
3. Enjoy solar cooked food!

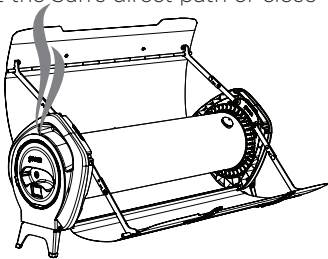

WARNING

- **Hot Contents.** Any item placed inside Cooking Tube can be extremely hot and cause severe burns.
- **Use Caution** when handling the device and implements. The GoSun Fusion can reach temperatures of up to 550°F, and will begin heating up as soon as it is exposed to Sunlight or the electric heating element is switched on. Because of the vacuum insulator, you cannot be burned by touching any exterior part of the GoSun Fusion. However, inner components can be extremely hot and must be handled with care.

6

COOK TIMES

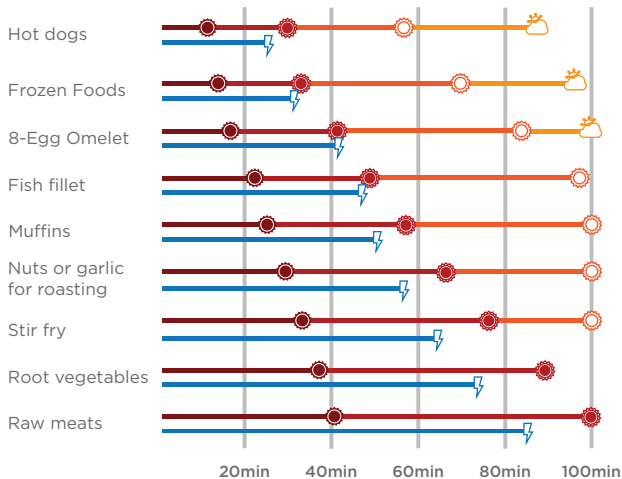
FULL
SUNGOOD
SUNMED.
SUNLOW
SUNNO
SUN

The GoSun Fusion's solar-cooking performance is unaffected by ambient temperatures and wind, cooking meals in frigid temperatures just as well as in hot weather. High humidity, pollution, and diffuse light (generally overcast or "thick" air) can significantly impact cooking times due to light scattering. In humid climates the GoSun Fusion will be most efficient in the Spring and Fall. It will not work in the shade without electricity.

7

COOKING TIPS

- Applying aluminum foil, oil or butter to the Cooking Tray before adding food helps to prevent sticking.
- Heat is generally distributed evenly to food in the Tube but foods at the end of the Tray (away from Handle) tend to cook faster than foods near the Tube's opening.
- Food along the bottom of the Tray will see more direct heat from the Integrated Electric Heater, and may therefore cook at a faster rate.
- Baked foods typically expand considerably (more than twice the uncooked volume), so start with small quantities and work up to the full tube size.
- The GoSun Fusion tends to trap a large amount of moisture from cooking food and can be used to easily steam vegetables. For a crispier meal, allow more steam to escape by keeping the Tray slightly open. Drain fluids periodically.

Other Resources:

- **www.gosun.co**
- **<https://www.facebook.com/groups/gosun/>**
Log on and join other GoSun enthusiasts to learn and share recipes and cooking tips.

9

STORAGE

1. Rotate the Reflectors back to the vertical position.
2. To close first Reflector: Push down on all four Reflector Arms to unlock them
3. Locate the Reflector with the Hooks on the outer face. Close this Reflector first.
4. Close the Reflector with the Rubber Latches on top of the first.
5. Pull Rubber Latches over Hooks to secure Reflectors.
6. Slightly lift one end of the Fusion and hinge the corresponding Leg closed until it seats into place.
7. Repeat Step 6 on the opposite Leg.

NOTE: The Legs will only seat into stored position when the Reflectors are oriented Vertically (facing straight up)

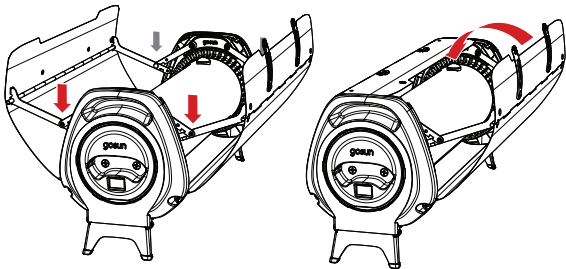

Maintenance

- 1.** Clean the cooking Tray after every use, clean the Tube when needed and only after it has cooled down.
- 2.** The stainless steel Cooking Tray can easily be cleaned by hand.
- 3.** It is recommended that you clean the inside of the glass Tube occasionally to prevent build-up of grease or food matter, which can affect the flavor of food.
- 4.** Keep surfaces of Tube and Reflectors clean with glass cleaner or mild soap.
- 5.** If the GoSun Cooking Tray becomes deformed after extensive use and becomes noticeably harder to insert into the tube, it can be remedied by squeezing the tray by hand.
- 6.** If the evacuated tube breaks, it can be removed and replaced by following the “Tube Removal” Section on the previous page. The GoSun Fusion uses the best evacuated tubes available on the market, however if they are damaged, a barium layer will oxidize and a white film will appear on the inside of the outer Tube, indicating that the Tube should be replaced.

Tube Removal

For repairing purposes or to do a deep clean of the GoSun Fusion, the tube can be removed from the rest of the device with the following procedures: If cleaning, ensure tube is at room temperature.

1. Remove the Cooking Tray.
2. Open both Reflectors (see “Open Stove”). (Figure A)
3. Focus on the open end of the product, specifically on the Silicone Cushion on the inner face of the End Cap.
4. Locate and remove the two bolts that connect the Reflector Arms to the End Cap. (Figure B)
5. Now on the outer face of the End Cap, locate and remove the three bolts along the bottom. (Figure C)
6. With all five bolts removed, slide the End Cap (with connected Leg) away from the body of the unit. (Figure D)
7. Slide the Silicone Cushion off of the Tube. (Figure D)
8. Carefully remove the Tube.
9. Reverse steps to install new tube.



WARNING

- **Wear protective gloves when handling broken tube to avoid risk of injury.**

A

End Cap

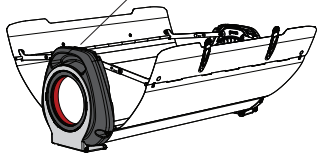
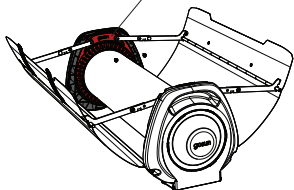
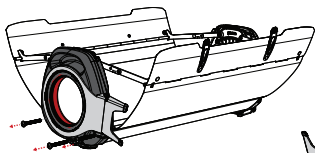
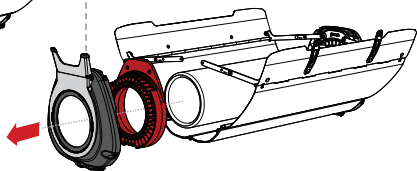
**B**Silicone
Cushion**C****D**

How It Works

OUTER SPACE IN A TUBE

At the heart of the GoSun is the evacuated glass Tube. It's not only a superior absorber of light, but also a fantastic insulator.

EXTERNAL COATINGS

- ☼ **ALUMINUM NITRIDE**
Catching and Absorbing Light
- **STAINLESS STEEL**
Conducting Heat
- ⌋ **COPPER**
Trapping Infrared Radiation

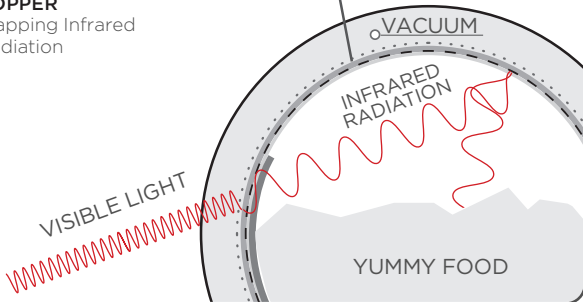
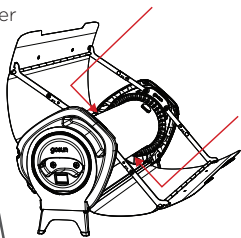

Specifications

- **Cooking Capacity:** 101 oz (3 L) of liquid
- **Dry Weight:** 14.5 lbs (6.6 kg)
- **Unit Size:** Length: 24.2" (61.5 cm), Height: 8.5" (21.6 cm), Width: 8.2" (20.8 cm)
- **Estimated Cooking Power:** [Sun] 200+ Watts in full sunlight, [Electric] 144W nominal @12Vdc.
- **Maximum Temperature:** 550°F (288°C)
- **Working Temperature:** 200°F (93°C) - 400°F (232°C)

Liability Release

By using the GoSun Fusion, the Purchaser and User acknowledges that cooking is an activity that puts you at some amount of risk. The Purchaser and User also acknowledge that it is critical to have read and understood the entire contents of the User's Manual. GoSun is not liable for damage or injury caused by misuse, abuse, or other outcomes resulting from failure to implement the proper instructions for use and safety provided in the user manual.

The Purchaser and User will thus release of the rights to sue for damage, injuries, or death resulting from the purchased, donated, loaned, rented, modified, or repaired equipment received from GoSun.

Purchasers and Users also understand that GoSun, and its employees, owners, officers, or agents (hereinafter "Released Parties"), shall not be held liable or responsible in any way for injury, death, or other damages to the User or his/her family, heirs, properties, or assigns which may occur as a result of the sold, donated, loaned, repaired, or modified equipment, or as a result of product defect, wear and tear, or the negligence of any party, including the Released Parties, whether passive or active.

Warranty



To activate your warranty, register at
www.gosun.co/register

The GoSun Fusion's evacuated tube is made of glass — It uses the same tough borosilicate glass as Pyrex, but it can break. All purchases are backed with a One-Year Limited Tube Warranty on the evacuated tube.

We're ensuring your satisfaction with a No-Questions-Asked-Policy; if you break the tube for any reason, we will cover the one-time cost of a new tube. You will have to cover a nominal shipping and handling fee. You will be required to provide some information, but you will not have to return the damaged tube. To claim your warranty, read the Warranty Policy below and send an email to support@gosunstove.com and follow instructions provided. Please direct your warranty inquiries either to your local retailer or to support@gosunstove.com. The rest of the package is guaranteed from manufacturing defects by a One-Year Limited Warranty. This does not cover damage caused by normal wear and tear, accident, improper care or cleaning, non-standard usage or negligence. Any replacements or exchanges will be at the discretion of GoSun Stove, based on the type of product sent in and the availability of replacement parts. Typically, most issues can be resolved with a little guidance or a replacement part.

WARRANTY POLICY

GoSun, Inc. extends this Limited Warranty to the original end-use purchaser of GoSun products* or the person receiving a Product as a gift, provided that the GoSun Stove Product was purchased from an Authorized Dealer as defined below. The Limited Warranty does not extend to any other person or transferee. Statutory or common law may provide additional rights or remedies that vary from state to state, and country to country, which are not affected by this Limited Warranty.

DEFINITIONS

“Authorized Dealer” means any distributor, reseller or retailer that was duly authorized by GoSun at the time of the sale to sell authentic GoSun products in the jurisdiction where it sold the Product, and that sold the Product in new, unused condition in its original packaging.

“Fraud or Misrepresentation” means misrepresenting any fact related to a warranty claim to GoSun, including the nature of the defect, whether the Product was purchased from an Authorized Dealer, and the authenticity of the Product.

“Intended Use” means use of the Product (a) for food preparation, (b) for private (as opposed to commercial) purposes, (c) in conformity with all applicable local, state or federal law, code or regulations, (d) in accordance with GoSun recommendations and/or instructions in the materials and documentation that accompany the Product.

SCOPE OF ONE-YEAR LIMITED TUBE WARRANTY

Evacuated tube failures claimed, submitted, reviewed and approved by GoSun, within one year of original purchase, will convert into a One-Time Tube Credit to the purchaser. The One-Time Tube Credit is then applied to a replacement tube to be sent directly to the purchaser’s address of choice. This Credit for may not be used toward any other GoSun products such as GoSun Apparel and accessories. Note that GoSun regularly changes the models, and styles of its Products and cannot guarantee the availability of an exact replacement for any Product. The Purchaser will be responsible for the cost of shipping and handling fees to receive their replacement tube. The exact cost for shipping and handling will be covered during the warranty claim process.

SCOPE OF ONE-YEAR LIMITED WARRANTY

GoSun provides a One-Year Limited Warranty against Manufacturing Defects. If a Product contained a Manufacturing Defect when it was purchased from an Authorized Dealer, GoSun, at its sole discretion, will (i) repair, (ii) replace, or (iii) provide a Warranty Credit for the Product on the GoSun online store. The amount of the Warranty Credit shall be equal to the purchase price of the Product paid to the Authorized Dealer. GoSun reserves the right to inspect any Product subject to a warranty claim to determine, at its sole discretion, whether the claimed defect is a Manufacturing Defect or otherwise.

GOSUN DOES NOT ASSUME ANY LIABILITY FOR ANY INCIDENTAL, CONSEQUENTIAL OR INDIRECT DAMAGES UNDER THIS LIMITED WARRANTY.

TERMS AND CONDITIONS

By submitting this warranty request, you agree to the following Terms and Conditions:

- In the case of Fraud or Misrepresentation, GoSun reserves the right to deny all warranty coverage or claims.
- Risk of Loss- GoSun is not responsible for any Product that is lost in shipping and not actually received by GoSun. To avoid unnecessary delays and minimize the possibility of a lost Product, we strongly suggest that you use the return label provided to you by GoSun's online warranty system to send your Product to GoSun. No warranty will be provided for any Product not actually received by GoSun.
- GoSun reserves the right to determine, at its sole discretion, whether a defect is a manufacturing defect and what type of credit or replacement shall be issued, if any.
- All warranty Products sent to GoSun will not be returned to you for any reason. Defective Products may be subject to engineering analysis and recycling, as part of our continued commitment to improving the quality of our products and the environment.

CHOICE OF LAW/JURISDICTION

This Limited Warranty and any disputes arising out of or in connection with this Limited Warranty ("Disputes") shall be governed by the laws of the State of Ohio, USA, excluding conflicts of law principles and excluding the Convention for the International Sale of Goods. The courts located in the State of Ohio, USA shall have exclusive jurisdiction over any Disputes.

OTHER RIGHTS

THIS LIMITED WARRANTY GIVES YOU SPECIFIC LEGAL RIGHTS, AND YOU MAY ALSO HAVE OTHER RIGHTS, WHICH VARY FROM STATE TO STATE AND JURISDICTION TO JURISDICTION, AND WHICH SHALL NOT BE AFFECTED BY THIS LIMITED WARRANTY. THIS WARRANTY EXTENDS ONLY TO YOU AND CANNOT BE TRANSFERRED OR ASSIGNED. If any provision of this Limited Warranty is unlawful, void or unenforceable, that provision shall be deemed severable and shall not affect any remaining provisions. In case of any inconsistency between the English and other versions of this Limited Warranty, the English version shall prevail.

REFUNDS AND EXCHANGES

All refunds and exchanges are handled through your retailer or distributor.

Contact Us

Please 'Like' us on Facebook and post your recipes or visit our website www.GoSun.co to learn more.

Activate your warranty now at www.gosun.co/register



Direct any questions or issues to:
support@gosunstove.com



Or call us at:
1-888-868-6154



Visit us on Facebook:
<https://www.facebook.com/gosunstove/>
<https://www.facebook.com/groups/gosun/>



Connect with us on Twitter:
[@gosunstove](https://twitter.com/gosunstove)



Connect with us on Instagram:
[@gosunstove](https://www.instagram.com/gosunstove)



Connect with us on Pinterest:
[@gosunstove](https://www.pinterest.com/gosunstove)



Patent Pending in USA and other countries.
Copyright © 2019 GoSun Inc. All rights reserved.

8

CLEANUP

1. Allow the device to completely cool down out of the Sun – this can take over an hour.
2. Using any mildly abrasive cleaning utensil, such as a bottle brush or sponge, clean both the inside of the Tray and the inside of the Tube with soap and water to remove oils and residues.
3. Use only a damp cloth with mild soapy water to clean the outside of the tray/heating element.
4. Rinse Tray and Tube as needed with water (tube must be cool). Do not soak under water.
5. Use a standard glass cleaner to clean the Reflectors and the outside of the Tube.
6. If doing a deep clean of the Fusion, see “Tube Removal” section of the manual.

Note: Cleaning is recommended every 3-4 uses (or after a spill) to prevent build-up of grease or food matter, which can affect the flavor of food. Deep clean only as needed.



WARNING

- **Cooking Tray is NOT dishwasher safe.**
- **DO NOT USE** harsh abrasives (such as steel wool), caustic cleaners or oven cleaners on this device.
- **DO NOT USE** acetone to clean this device. Use only mild soapy water or fresh tap water.