

SHUTTER WALL

INSTRUCTION MANUAL

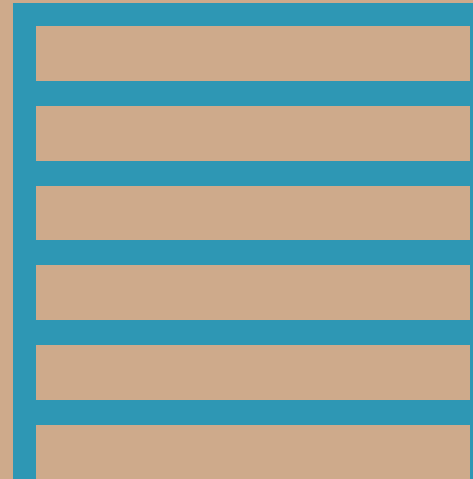

THANK YOU FOR PURCHASING THE MIRADOR SHUTTER WALL!



This manual will provide you with clear and detailed instructions on how to safely and correctly assemble and maintain your shutter wall, to ensure it brings you many years of use and enjoyment.

IMPORTANT

Please read the entire manual carefully before assembling and using your shutter wall, and please ensure the manual is kept in a safe place for future reference.

Any use or modification to the shutter wall not included in this manual shall be considered as improper use, which may cause considerable danger to users and property and will void the product warranty.

Please only use this product for its intended purpose within a residential environment. Failure to do so will void your warranty.

We reserve the right to make changes for product improvements.

For parts and customer service, please call +1 (877)-506-4777 in the U.S. and Canada (English and Spanish) Monday - Friday: 6:30 am - 4:30 pm, Saturday – Sunday: 8:30 am – 4:30 pm, Pacific Time. Or email: support@miradoroutdoor.com

Digital instruction manual is also available on our official website www.miradoroutdoor.com for your reference.

TABLE OF CONTENTS

- Before Assembling Your Shutter Wall	3
- Important Safety Advice	5
- List of Parts	7
- Assembly	8
- Enjoy Your Shutter Wall	10
- Care & Maintenance	11
- Warranty & Complaints Procedure	12
- Certification Information	13

BEFORE ASSEMBLING YOUR SHUTTER WALL

Please read all the instructions carefully before you begin, and follow the steps in the order they are presented.

Make sure you have all the tools required for assembling your shutter wall

In order to assemble your shutter wall safely and correctly, please ensure you have access to the following tools and accessories, all of which are not provided.



Hard hat



Protective gloves



Box cutter

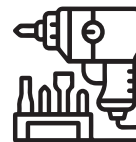

Electric Screwdriver



Hammer drill

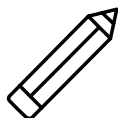

Pencil



2 Step ladders



Hammer

Check to ensure there are no missing parts:





Before you begin assembly, please check that you have all the parts required to assemble your shutter wall. Please also carefully check that the quantity of parts match with that of the model you have purchased.

If any parts are missing, please refer **Warranty & Complaints Procedure** to contact customer service before beginning the assembly.

Prepare the parts you will need for each step:

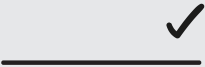
In the **Assembly** section of the manual, each step indicates the necessary parts and quantities required to complete the step. We recommend that you prepare the parts you will need for each assembly step. Doing this will save you time and effort during assembly. If possible, place the parts on cardboard or other soft surface to protect from scratching the painted surfaces.

Select a suitable location:

The ground should be solid and flat	The ground should be level	The shutter wall must be positioned and fixed on a properly installed Mirador pergola, which is installed on a flat concrete ground, providing proper stability.
		
		

Warning:

Most terraces or patios are designed with a slight slope to prevent (rain) water from forming pools or reaching the house or other structures. For the perfect shutter wall assembly, a level concrete surface without such a slope is required. Small pebbles could also prevent the shutter wall from being safely secured on the ground.

If the shutter wall is installed on an uneven surface, it may prevent accessory components from working correctly and may void the product warranty.

Prepare a foundation:





To prepare it, you need to:

- check for underground pipes and cables (Call 811 before you dig if you live in the USA)
- check with your local authorities regarding any building permits that may be required
- contact a reliable contractor to have concrete base if you don't have one



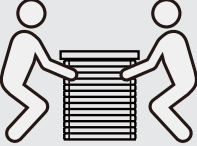
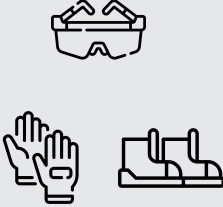
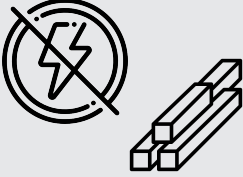
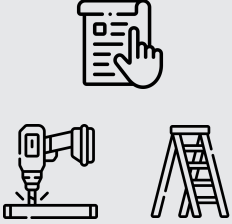

Do not assemble the shutter wall on sandy, muddy or loose soil, as the stakes do not have the sufficient anchorage to be installed in these types of soil.

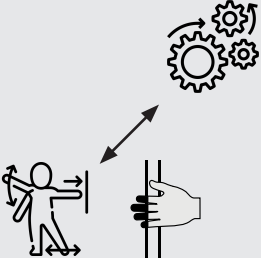

IMPORTANT SAFETY ADVICE

For the safety of all persons assembling and using the shutter wall, it is important to follow the safety guidelines below.





<p>It is recommended that two people lift the shutter wall once assembled. Ensure you lift with the correct posture & technique.</p>	<p>Always wear appropriate work shoes, gloves and eye protection when working.</p>	<p>Work well away from power lines, particularly when handling metal parts.</p>	<p>If using power tools or a ladder, always follow the manufacturer's safety instructions.</p>
			
<p>Make sure the shutter wall complies with local building regulatory codes.</p>	<p>Working at heights can be dangerous. Always wear protective clothing to prevent injury in the event of a fall.</p>	<p>Only use ladders and scaffolding with a sufficiently high load bearing capacity.</p>	<p>Be careful not to get clothing or body parts caught in the shutter wall when they are in motion.</p>
			

<p>Do not assemble the shutter wall when you find damaged parts or any parts missing. Only use replacement parts that are approved by the manufacturer.</p>	<p>Please recycle packaging where possible.</p>	<p>After prolonged use we recommend you check all the fittings are tightened securely.</p>	<p>Install on non-Mirador branded pergola will void the product warranty and can damage the operation mechanism.</p>
 <p>✓ Approved</p>			 <p>Mirador®</p>

<p>Changes to the design or configuration of equipment may not be made without consulting the manufacturer or authorized representative.</p>	<p>Do not attempt to assemble the shutter wall if you are tired or have taken alcohol.</p>	<p>Hot items such as recently used grills, fire pits etc. must not be stored close to the shutter wall.</p>	<p>Keep children and pets away from the assembly area until the work is completed.</p>
			

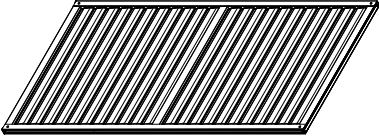
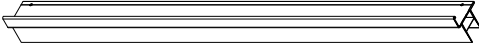
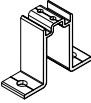
<p>Do not attempt to assemble the shutter wall in windy or wet conditions.</p>	<p>Do not touch moving parts during operation.</p>	<p>Dispose of all plastic bags safely. Keep them out of the reach of children.</p>
		

LIST OF PARTS

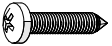
	REF	Part Name	QTY
A		Shutter wall	1
B		Top track	1
C		Foot Pad	2
D		Plastic Expansion Pipe 8x40mm	4
E		Screw ST5.5x50mm	4
F		Screw ST4.8x25mm	2
G		Screw ST4.2x20mm	4

ASSEMBLY



Assembly Video

1

Hang the top track **B** over the beam (against the pergola pillar or in the center).

Fasten top track **B** to beam with 2 screws **F**, using electric screwdriver.

F x 2 

B x 1 

Sectional view

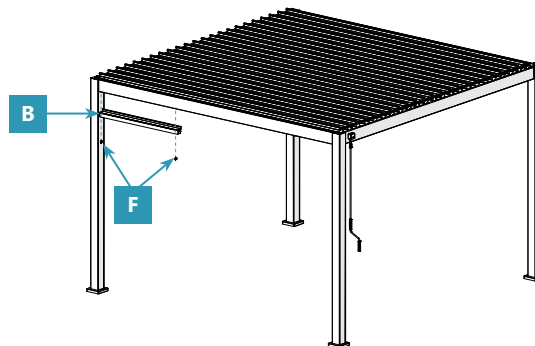
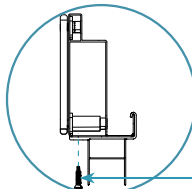
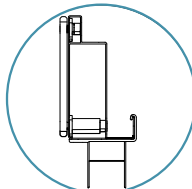
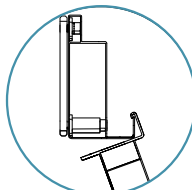

2

Assemble the foot pads **C** to the bottom of the shutter wall **A** with 4 screws **G** clockwise. Using electric screwdriver.

A x 1

C x 2

G x 4

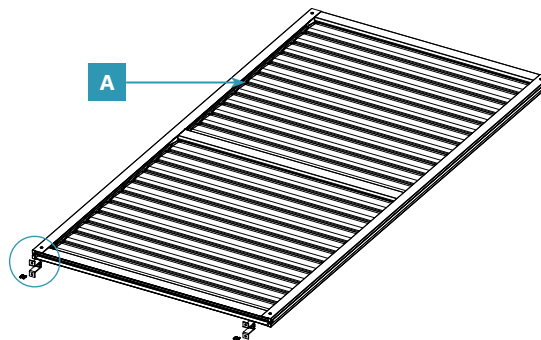
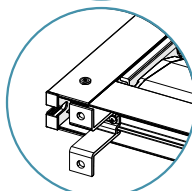
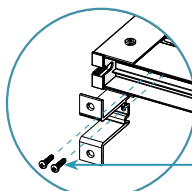

3

Lift shutter wall **A** up into the top track **B**, make sure the shutter wall is perpendicular to the ground. Mark the position of the drill holes on the ground with pencil.

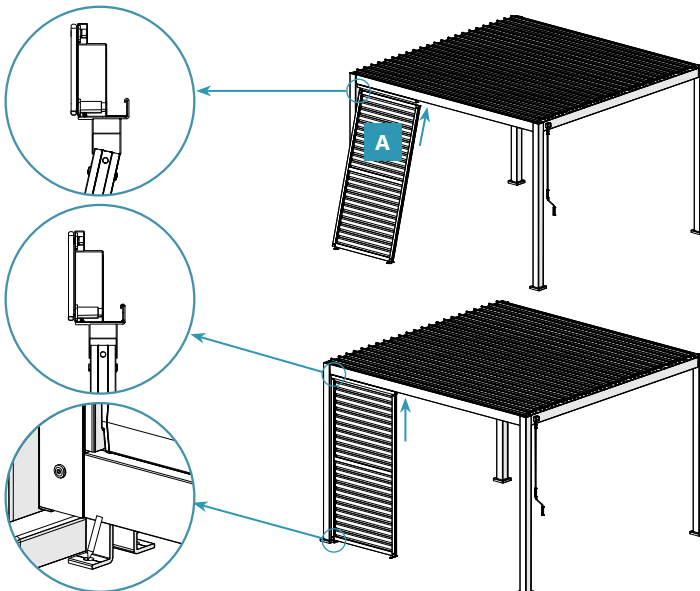

4

Remove the wall, drill holes with hammer drill and knock in the plastic expansion pipe **D** with hammer.

D x 4 

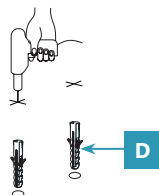

5

Fix the shutter wall to the ground with screw **E**, using electric screwdriver.

Notice: Always start from the left / right hand side shutter wall if it is intended to assemble more than 1 shutter wall on one side of the pergola. Repeat steps

E x 4 

1 - 5 to assemble the other shutter walls.

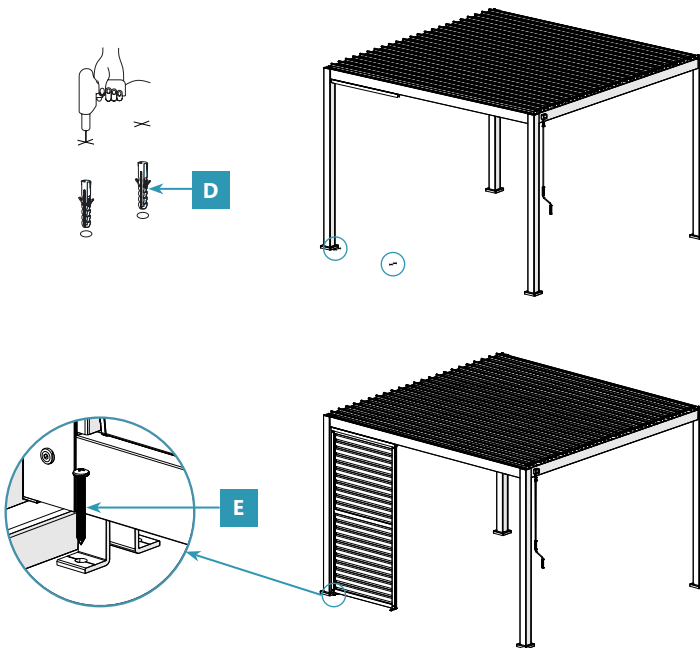



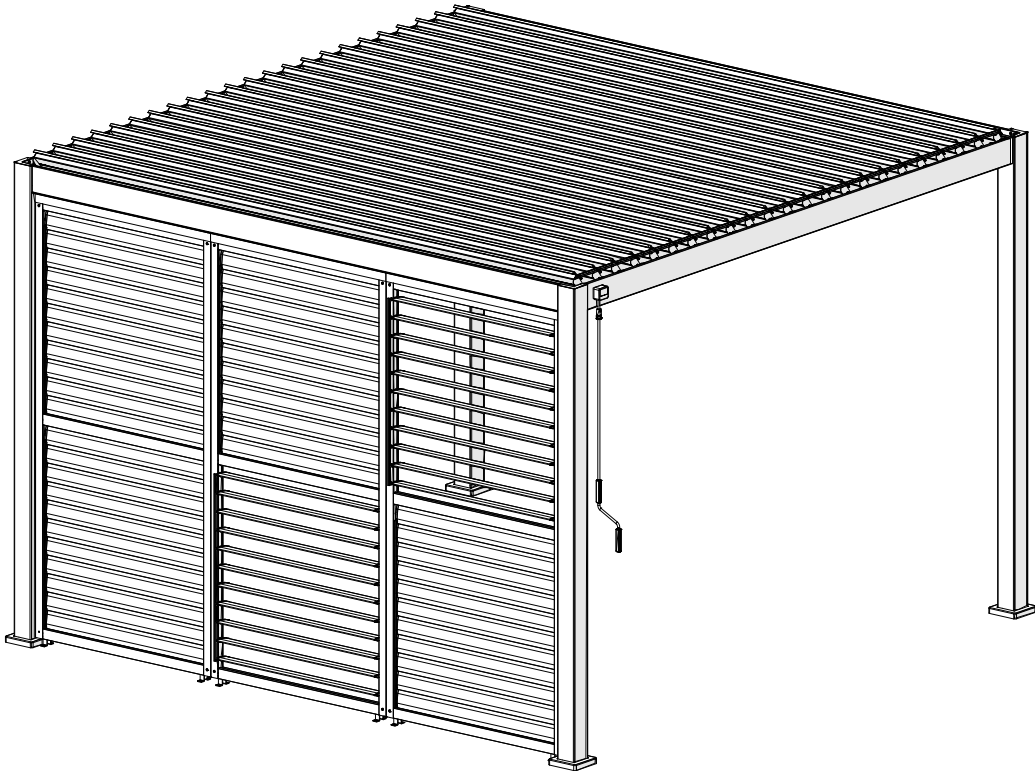



ENJOY YOUR SHUTTER WALL

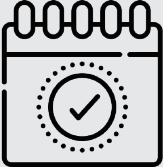

The louvers on the upper and lower sections of each door can be individually adjusted to meet your personal preferences.

CARE & MAINTENANCE

<p>Dust and dirt will collect on the shutter wall and will require periodic cleaning.</p>	<p>Use a water/detergent mixture and a soft clean cloth to clean the shutter wall.</p>	<p>Air dry or wipe with a soft clean cloth.</p>
		
<p>In coastal areas, it is recommended that you frequently spray the shutter wall with water to reduce accumulation of salt and dirt.</p>	<p>From more soiled areas, rinse the surface with clean water from top to bottom.</p>	<p>Do not use any acidic, alkaline or petroleum based spray lubricants.</p>
		

* Alcohol based cleaner: methyl alcohol, ethyl alcohol, butyl alcohol, Isopropyl alcohol, etc.

WARRANTY & COMPLAINTS PROCEDURE

For terms and conditions of our limited warranty, please visit www.miradoroutdoor.com or contact your local Mirador sales representative.

Complaints procedure:

- The complaint must include an order number or transaction number. Goods without an order number or transaction number are not covered under the warranty.
- The complaint must include a detailed description of the defect, the name of the company which assembled the product if 3rd party was used and the date when the defect was discovered.
- At Sorara Outdoor Living USA Inc's discretion, customer must offer supplier the photos/videos of the issue/damaged parts. Otherwise, supplier reserves the right to refuse replacement parts or credit.
- Please save a copy of your purchase receipt.

Contact:

Customer Service: support@miradoroutdoor.com

Need Assistance? Call +1 (877)-506-4777

Hours of Operation:

Phone Support: Monday - Friday: 6:30 am - 4:30 pm, Saturday – Sunday: 8:30 am – 4:30 pm, PST.

Email Support: We are available 24 hours a day. Please allow up to 24 hours for a response.

Chat With Us Online: miradoroutdoor.com, Monday - Friday: 5:30 am - 2:00 pm, Saturday – Sunday: 8:30 am – 4:30 pm, PST.

Note: Our team is available to assist you during these hours. If you have any inquiries or require support outside of these hours, please leave a voicemail, send an email, or use our online contact form. We will get back to you promptly during the next available support hours. Thank you for choosing Mirador Outdoor!

CERTIFICATION INFORMATION

Declaration of performance (DOP)

Reference no. DOP0004

Product name and type

Mirador Panel shutter / Sliding shutter

Model name/ Unique identification code of the product:

111 Shutter Wall A, 111 Louver Wall A,

A: - For 4m Side , - For 3.6m Side , - For 3m Side

111 Sliding Shutter Wall Am, 111 Sliding PC Wall Am,

A: 3m , 3.6 m , 4m

Purpose of Usage:

External use in buildings and other construction works

Manufacturer:

Zhejiang Zhengte Co., Ltd.

811 Dongfang Ave, Zhejiang, PRC

Documentation officer:

Ziad Zhao

Zhejiang Zhengte Co., Ltd.

No.811 Oriental Ave., Linhai, 317004, Zhejiang, China

System for assessing and verifying the constancy of performance according to Annex V of the Construction Products Directive 305/2011/EC

System 4

Declared performance (Excluding the structural part):

111 Sliding PC Wall Am , Wind resistance = Class 4

others Model Wind resistance = Class 6

Standard: EN 13659:2015+A1:2008

Zhejiang

15.12.23

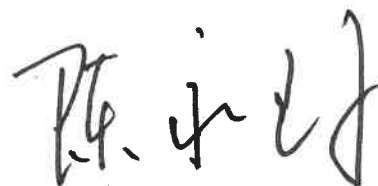

(Chairman/President)

more to
enjoy

MIRADOR® is a registered trademark
of Zhejiang Zhengte Co., Ltd.
© 2024 Sorara Outdoor Living USA .
All rights reserved.



Printed on 100%
post-consumer
recycled paper

FOLLOW US ON
WWW.MIRADOROUTDOOR.COM
@miradoroutdoor @MiradorOutdoor
@miradoroutdoor @miraadoroutdoor