

Product Datasheet

Model :
S-71144-BK-8W-3000



Electrical parameters

Driver	PHILIPS drive
LED CHIP	Epister Chip
Driver life span	10000H
Input voltage	240-220V, 60/50HZz

Technical general

System power	8W
Color temperature	3000
Finish color	Black
Material	ring surface is made of high quality aviation aluminum

size

Fixture size-mm	Ø55*85mm
Cut out-mm	Ø70mm

Warranty:3 year

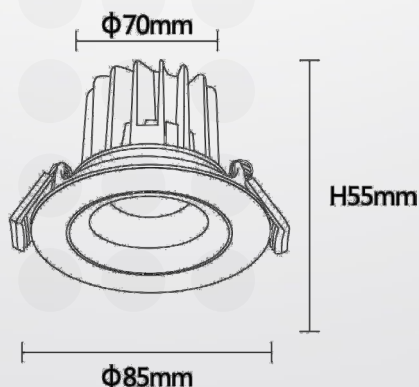

מקX לייט בע"מ יבוא ושיווק גופי תאורה