



CORAL

FROSTED WALL LIGHT

Designed and Handmade by Oliver Höglund & Ryan Roberts

Embellish your walls with the Coral wall light, available in both clear and frosted finishes. This statement piece adds a modern contemporary feature ideal for kitchens, bedrooms, bathrooms and entryways. Tailor it to your preferences by selecting a wall plate finish of brass finish, matte black, matte white, medium bronze or steel finish and set the mood of your space with a choice of warm, warm white, or white LED temperatures. Meticulously hand-blown using premium Swedish clear glass, each disc carries the distinctiveness of SOKTAS Glass designs, promising an unparalleled and personalised lighting masterpiece that adds both elegance and character to your space.

Hand Made in Currumbin, Australia.



TECHNICAL DATA

Application	Interior & Outdoor Use	Input Power	100-240V AC
Glass	Frosted	Output Power	4V DC Driver (350mA Constant Current) Supplied with Remote Driver
Cover Cap Finish	Matte Black / Matte White / Brass Finish / Steel Finish / Medium Bronze Powdercoat	Dedicated LED	1W - 350mA (Standard) / 2W (additional cost) Lifespan - 60,000+ Hours CRI>90
Wall Mount Finish	Matte Black / Matte White / Brass Finish / Steel Finish / Medium Bronze Powdercoat	Colour Temperature	2700K / 3000K (Standard) / 4000K
Glass Dimensions	Small: 120 - 140mm Medium: 150 - 170mm Large: 200 - 220mm Wall Mount: 110 x 15mm Protrudes: 50mm	Dimming	Triac-Dimmable (Standard) Optional: DALI (additional cost) Please contact for alternative dimming options
IP Rating	IP65	Mounting	Integral Wall Bracket
Warranty	24 Months / 2 Years	Certification	AU/NZ AS/NZS 60598.1, 60598.2.1 EU EN 60598.1, 60598.2.1 US/CAN ETL/UL 1598, CSA C22.2#250.0

DIMENSIONS

MOUNTING

Glass Installation

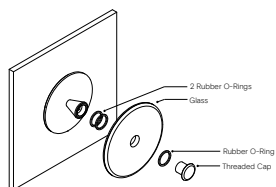

To install the glass piece, hold the glass against the LED housing and thread the 30mm threaded cap into the LED housing.
*Ensure the rubber o-rings are installed in the correct position, with 2 behind the glass and 1 in front on the glass. If the glass is not held firmly when the threaded cap is fully screwed in, install an extra o-ring in front of the glass.

Wall Plate Dimensions

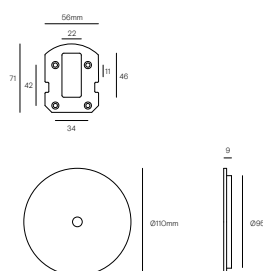

Installation Instructions

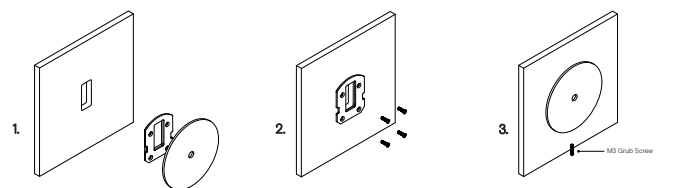

Prep the wall with a hole match the wall plate cutout. Secure the transformer into the wall cavity and feed the cable through the hole into the room. Connect the single electrified cable to the transformer.

Screw the mounting plate to the wall using appropriate fasteners for the wall substrate.

Fit the circular wall plate over the mounting plate and secure with the supplied M3 grub screw at the bottom of the plate.

*The transformer needs to be accessible for maintenance purposes.



CORAL ORGANIC WALL LIGHT

Designed and Handmade by Oliver Höglund & Ryan Roberts

Illuminate your space with the Coral Organic wall light, a refined and distinctive clear glass-blown element available in a frosted and clear finish meticulously crafted to enhance bathrooms, hallways, and kitchen areas. Every light is individually hand-blown, ensuring a one-of-a-kind organic form that creates enchanting shadow play across your walls. Tailor it to your preferences by selecting a wall plate finish of brass finish, matte black, matte white, medium bronze or steel finish and set the mood of your space with a choice of warm, warm white, or white LED temperatures. Meticulously hand-blown using premium Swedish clear glass, each piece carries the distinctiveness of SOKTAS Glass designs, promising an unparalleled and personalised lighting masterpiece that adds both elegance and character to your space.

Hand Made in Currumbin, Australia.



TECHNICAL DATA

Application	Interior & Outdoor Use	Input Power	100-240V AC
Glass	Frosted / Clear	Output Power	4V DC Driver (350mA Constant Current) Supplied with Remote Driver
Cover Cap Finish	Matte Black / Matte White / Brass Finish / Steel Finish / Medium Bronze Powdercoat	Dedicated LED	1W - 350mA (Standard) / 2W (additional cost) Lifespan - 60,000+ Hours CRI>90
Wall Mount Finish	Matte Black / Matte White / Brass Finish / Steel Finish / Medium Bronze Powdercoat	Colour Temperature	2700K / 3000K (Standard) / 4000K
Glass Dimensions	180 - 220mm Wall Mount: 110 x 15mm Protrudes: 50mm	Dimming	Triac-Dimmable (Standard) Optional: DALI (additional cost) Please contact for alternative dimming options
IP Rating	IP65	Mounting	Integral Wall Bracket
Warranty	24 Months / 2 Years	Certification	AU/NZ AS/NZS 60598.1, 60598.2.1 EU EN 60598.1, 60598.2.1 US/CAN ETL/UL 1598, CSA C22.2#250.0

DIMENSIONS

MOUNTING

Glass Installation

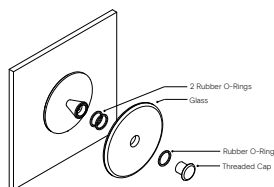

To install the glass piece, hold the glass against the LED housing and thread the 30mm threaded cap into the LED housing.
*Ensure the rubber o-rings are installed in the correct position, with 2 behind the glass and 1 in front on the glass. If the glass is not held firmly when the threaded cap is fully screwed in, install an extra o-ring in front of the glass.

Wall Plate Dimensions

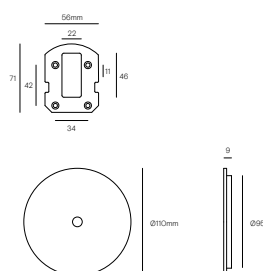

Installation Instructions

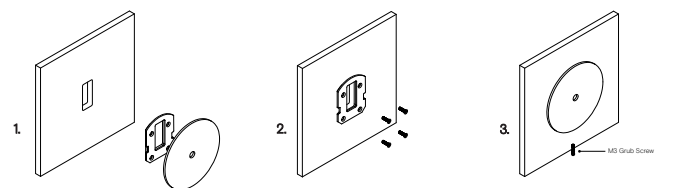

Prep the wall with a hole match the wall plate cutout. Secure the transformer into the wall cavity and feed the cable through the hole into the room. Connect the single electrified cable to the transformer.

Screw the mounting plate to the wall using appropriate fasteners for the wall substrate.

Fit the circular wall plate over the mounting plate and secure with the supplied M3 grub screw at the bottom of the plate.

*The transformer needs to be accessible for maintenance purposes.



CORAL

TRIO PENDANT - OFF CENTERED

Designed and Handmade by Oliver Höglund & Ryan Roberts

Elevate your space with the Coral Trio pendant light, a captivating modern centrepiece perfect for entryways, bathrooms, and kitchen islands. Three exquisite glass-blown discs are elegantly suspended from a rod, available in a selection of finishes including natural brass, steel finish, matte black, matte white, or medium bronze powder coating. Available in a centred or off-centred installation, opt for frosted or clear glass to match your style and set the mood with a choice of warm, warm white, or white LED temperatures. Meticulously hand-blown using premium Swedish clear glass, each disc carries the distinctiveness of SOKTAS Glass designs, promising an unparalleled and personalised lighting masterpiece that adds both elegance and character to your space.

Hand Made in Currumbin, Australia.



TECHNICAL DATA

Application	Interior Use Only	Input Power	100 - 240VAC
Glass Colour	Frosted / Clear	Output Voltage Standard	4V DC Driver (350mA Constant Current) Supplied with Remote Driver
Suspension Rod	Natural Brass / Matte Black / Matte White / Steel Finish / Medium Bronze Powdercoat	Dedicated LED	3 x 1W - 350mA (Standard) 3 x 2W - 350mA (additional cost) Lifespan - 60,000+ Hours CRI>90
Glass Diameter	Small: 120 - 140mm Medium: 150 - 170mm Large: 200 - 220mm	Colour Temperature	2700K / 3000K (Standard) / 4000K
Rod Length	1200mm (Standard) (custom lengths available)	Dimming	Yes - Dimmable TRIAC/Phase (Standard) Dimmable DALI (additional cost) Please contact for alternative dimming
Certification	AU/NZ AS/NZS 60598.1, 60598.2.1 EU EN 60598.1, 60598.2.1 US/CAN ETL/UL 1598, CSA C22.2#250.0	Warranty	24 Months / 2 Years

DIMENSIONS

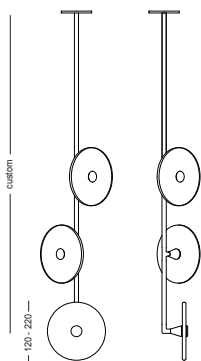

Glass Installation

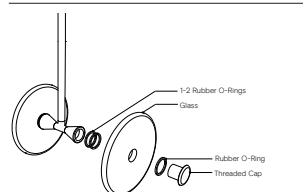

To install the glass piece, hold the glass against the LED housing and thread the 30mm threaded cap into the LED housing.

*Ensure the rubber o-rings are installed in the correct position, 1 behind the glass, and 1 in-front on the glass. If the glass is not held firmly when the threaded cap is fully screwed in, install an extra o-ring.

MOUNTING

Installation Instructions

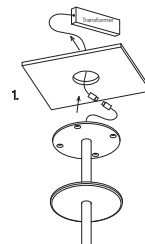

Prep the ceiling with an approx. 50mm hole to fit the transformer. Place the transformer in the ceiling and feed the cable through the hole into the room. Connect the single electrified cable to the transformer.

*The transformer needs to be accessible for maintenance purposes.

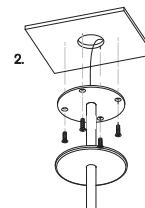

Screw the steel mounting plate to the ceiling using appropriate fasteners for the ceiling substrate.

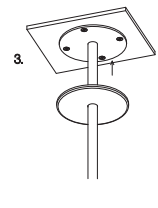

Secure the magnetic cover plate onto the mounting plate.



FLO WALL LIGHT

Designed and Handmade by Oliver Höglund & Ryan Roberts

Adorn your walls with the Flo wall light, a unique statement piece that adds a modern contemporary feature ideal bedrooms and bathrooms. Boasting a unique and one of a kind look that elevates any space. Tailor it to your preferences by selecting a wall plate finish of brass finish, matte black, matte white, medium bronze or steel finish and set the mood of your space with a choice of warm, warm white, or white LED temperatures. Meticulously hand-blown using premium Swedish clear glass, each piece carries the distinctiveness of SOKTAS Glass designs, promising an unparalleled and personalised lighting masterpiece that adds both elegance and character to your space.

Hand-Blown in Currumbin, Australia



TECHNICAL DATA

Application	Interior Use (Optional: Outdoor Use) Low Voltage (under 12v)	Input Power	100-240V AC
Glass	Clear	Output Power	4V DC Driver (350mA Constant Current) Supplied with Remote Driver
Wall Plate Finish	Matte Black / Matte White / Brass Finish / Steel Finish / Medium Bronze Powdercoat	Dedicated LED	1W - 350mA (Standard) / 2W (additional cost) Lifespan - 60,000+ Hours CRI>90
Dimensions	Glass: Length 180 - 220mm / Width: 80 - 110mm Mounting Plate: 110 x 15mm Protrudes: 100 - 120mm	Lumen Output	150lm (1W) (Standard) / 300lm (2W)
Weight	0.5kg	Colour Temperature	2700K / 3000K (Standard) / 4000K
IP Rating	IP20 Indoor (Optional: IP55 Outdoor)	Dimming	Triac-Dimmable (Standard) Optional: DALI (additional cost) Please contact for alternative dimming options
Warranty	24 Months / 2 Years	Mounting	Integral Wall Bracket
Certification	AU/NZ AS/NZS 60598.1, 60598.2.1 EU EN 60598.1, 60598.2.1 US/CAN ETL/UL 1598, CSA C22.2#250.0		

DIMENSIONS

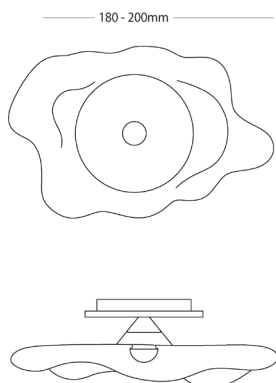

MOUNTING

Installation Instructions

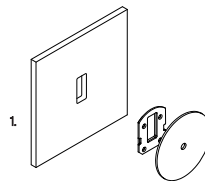

1. Prep the wall with an hole match the wall plate cutout. Secure the transformer into the wall cavity and feed the cable through the hole into the room. Connect the single electrified cable to the transformer.

*The transformer needs to be accessible for maintenance purposes.

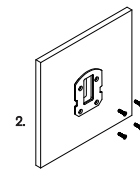

2. Screw the mounting plate to the wall using appropriate fasteners for the wall substrate.

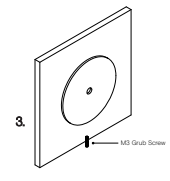

3. Fit the circular wall plate over the mounting plate and secure with the supplied M3 grub screw at the bottom of the plate.



FLO ROUND WALL LIGHT

Designed and Handmade by Oliver Höglund & Ryan Roberts

Adorn your walls with the Flo round wall light, a unique statement piece that adds a modern contemporary feature ideal bedrooms and bathrooms. Boasting a unique and one of a kind look that elevates any space. Tailor it to your preferences by selecting a wall plate finish of brass finish, matte black, matte white, medium bronze or steel finish and set the mood of your space with a choice of warm, warm white, or white LED temperatures. Meticulously hand-blown using premium Swedish clear glass, each piece carries the distinctiveness of SOKTAS Glass designs, promising an unparalleled and personalised lighting masterpiece that adds both elegance and character to your space.

Hand-Blown in Currumbin, Australia



TECHNICAL DATA

Application	Interior Use (Optional: Outdoor Use) Low Voltage (under 12v)	Input Power	100-240V AC
Glass	Clear	Output Power	4V DC Driver (350mA Constant Current) Supplied with Remote Driver
Wall Plate Finish	Matte Black / Matte White / Brass Finish / Steel Finish / Medium Bronze Powdercoat	Dedicated LED	1W - 350mA (Standard) / 2W (additional cost) Lifespan - 60,000+ Hours CRI>90
Dimensions	Glass: Width 110 -120mm Mounting Plate: 110 x 15mm Protrudes: 50mm	Lumen Output	150lm (1W) (Standard) / 300lm (2W)
Weight	0.5kg	Colour Temperature	2700K / 3000K (Standard) / 4000K
IP Rating	IP20 Indoor (Optional: IP55 Outdoor)	Dimming	Triac-Dimmable (Standard) Optional: DALI (additional cost) Please contact for alternative dimming options
Warranty	24 Months / 2 Years	Mounting	Integral Wall Bracket
Certification	AU/NZ AS/NZS 60598.1, 60598.2.1 EU EN 60598.1, 60598.2.1 US/CAN ETL/UL 1598, CSA C22.2#250.0		

DIMENSIONS

— 110-120mm —

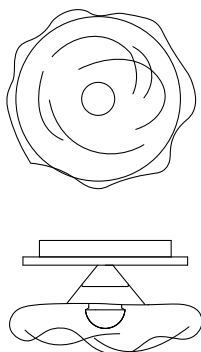

MOUNTING

Installation Instructions

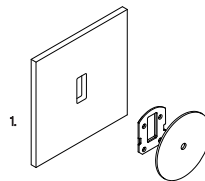

1. Prep the wall with an hole match the wall plate cutout. Secure the transformer into the wall cavity and feed the cable through the hole into the room. Connect the single electrified cable to the transformer.

*The transformer needs to be accessible for maintenance purposes.

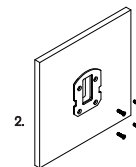

2. Screw the mounting plate to the wall using appropriate fasteners for the wall substrate.

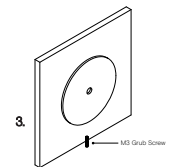

3. Fit the circular wall plate over the mounting plate and secure with the supplied M3 grub screw at the bottom of the plate.



SOL WALL LIGHT

Designed and Handmade by Oliver Höglund & Ryan Roberts

Brighten your environment with the Sol wall light, a sophisticated clear glass-blown fixture designed to elevate bathrooms, hallways, and kitchen spaces. Directly translating to "sun" in Norwegian, the Sol light infuses the same warmth into any setting it graces. Tailor it to your preferences by selecting a wall plate finish of brass finish, matte black, matte white, medium bronze or steel finish and set the mood of your space with a choice of warm, warm white, or white LED temperatures. Meticulously hand-blown using premium Swedish clear glass, each piece carries the distinctiveness of SOKTAS Glass designs, promising an unparalleled and personalised lighting masterpiece that adds both elegance and character to your space.

Hand-Blown in Currumbin, Australia.



TECHNICAL DATA

Application	Interior Use (Optional: Outdoor Use) Low Voltage (under 12v)	Input Power	100 - 240VAC
Glass Colour	Clear	Output Voltage	4V DC Driver (350mA constant current) Supplied with Remote Driver
Wall Plate Finish	Matte Black / Matte White / Brass Finish / Steel Finish / Medium Bronze Powdercoat	Dedicated LED	1W - 350mA (Standard) / 2W (additional cost) Lifespan - 60,000+ Hours CRI>90
Dimensions	Glass: 160 - 200mm Wall Mount: 110 x 15mm Protrudes: 80mm	Lumen Output	150lm (1W) (Standard) / 300lm (2W)
Warranty	24 Months / 2 Years	Colour Temperature	2700K / 3000K (Standard) / 4000K
IP Rating	IP20 Indoor (Optional: IP55 Outdoor)	Dimming	Triac-Dimmable (Standard) Optional: DALI (additional cost) Please contact for alternative dimming options
Certification	AU/NZ AS/NZS 60598.1, 60598.2.1 EU EN 60598.1, 60598.2.1 US/CAN ETL/UL 1598, CSA C22.2#250.0	Mounting	Integral Wall Bracket

DIMENSIONS

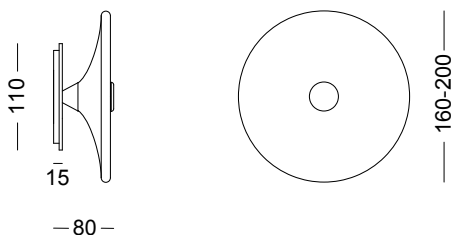

MOUNTING

Installation Instructions

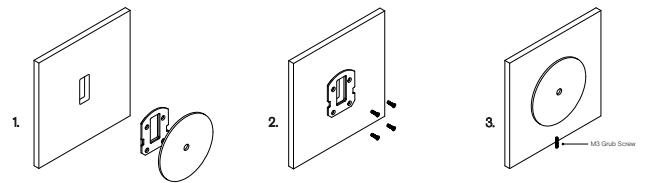

1. Prep the wall with an hole match the wall plate cutout. Secure the transformer into the wall cavity and feed the cable through the hole into the room. Connect the single electrified cable to the transformer.

2. Screw the mounting plate to the wall using appropriate fasteners for the wall substrate.

3. Fit the circular wall plate over the mounting plate and secure with the supplied M3 grub screw at the bottom of the plate.

*The transformer needs to be accessible for maintenance purposes.



CORAL TRIO ROD

CENTERED WALL LIGHT

Designed and Handmade by Oliver Höglund & Ryan Roberts

Embellish your walls with the Coral Trio Rod wall light and add a modern contemporary feature ideal for kitchens, bedrooms, bathrooms and entryways. This statement piece features three hand-blown glass discs available in both clear and frosted finishes. Tailor it to your preferences by selecting a wall plate finish of natural brass, matte black, matte white, medium bronze or steel finish and set the mood of your space with a choice of warm, warm white, or white LED temperatures. Meticulously hand-blown using premium Swedish clear glass, each disc carries the distinctiveness of SOKTAS Glass designs, promising an unparalleled and personalised lighting masterpiece that adds both elegance and character to your space.

Hand Made in Currumbin, Australia.



TECHNICAL DATA

Application	Interior Use (Optional: Outdoor Use) Low Voltage (under 12v)	Input Power	100-240V AC
Glass	Frosted / Clear	Output Power	4V DC Driver (350mA Constant Current) Supplied with Remote Driver
Wall Mount Finish	Matte Black / Matte White / Natural Brass / Steel Finish / Medium Bronze Powdercoat	Dedicated LED	3 x 1W - (Standard) / 3 x 2W (additional cost) Lifespan - 60,000+ Hours CRI>90
Glass Dimensions	150mm Wall Mount: 110 x 15mm Protrudes: 90mm	Colour Temperature	2700K / 3000K (Standard) / 4000K
Overall Length	500mm	Dimming	TRIAC/Phase Dimmable (Standard) DALI (additional cost) Please contact for alternative dimming options
IP Rating	IP20 Indoor	Mounting	Integral Wall Bracket
Warranty	24 Months / 2 Years	Certification	AU/NZ AS/NZS 60598.1, 60598.2.1 EU EN 60598.1, 60598.2.1 US/CAN ETL/UL 1598, CSA C22.2#250.0

DIMENSIONS

MOUNTING

Glass Installation

Wall Plate Dimensions

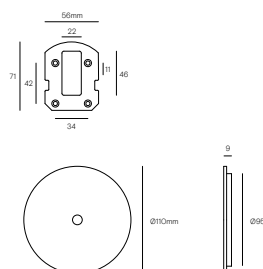
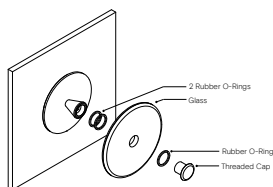

To install the glass piece, hold the glass against the LED housing and thread the 30mm threaded cap into the LED housing.

*Ensure the rubber o-rings are installed in the correct position, with 2 behind the glass and 1 in front on the glass. If the glass is not held firmly when the threaded cap is fully screwed in, install an extra o-ring in front of the glass.

Installation Instructions

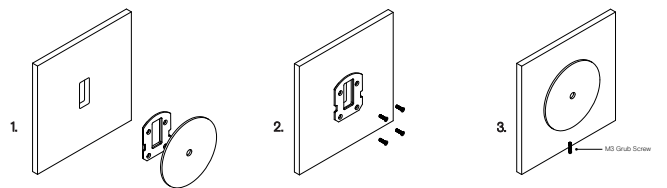

Prep the wall with a hole match the wall plate cutout. Secure the transformer into the wall cavity and feed the cable through the hole into the room. Connect the single electrified cable to the transformer.

Screw the mounting plate to the wall using appropriate fasteners for the wall substrate.

Fit the circular wall plate over the mounting plate and secure with the supplied M3 grub screw at the bottom of the plate.

*The transformer needs to be accessible for maintenance purposes.



CORAL TRIO ROD

OFF-CENTERED WALL LIGHT

Designed and Handmade by Oliver Höglund & Ryan Roberts

Embellish your walls with the Coral Trio Rod wall light and add a modern contemporary feature ideal for kitchens, bedrooms, bathrooms and entryways. This statement piece features three hand-blown glass discs available in both clear and frosted finishes. Tailor it to your preferences by selecting a wall plate finish of natural brass, matte black, matte white, medium bronze or steel finish and set the mood of your space with a choice of warm, warm white, or white LED temperatures. Meticulously hand-blown using premium Swedish clear glass, each disc carries the distinctiveness of SOKTAS Glass designs, promising an unparalleled and personalised lighting masterpiece that adds both elegance and character to your space.

Hand Made in Currumbin, Australia.



TECHNICAL DATA

Application	Interior Use (Optional: Outdoor Use) Low Voltage (under 12v)	Input Power	100-240V AC
Glass	Frosted / Clear	Output Power	4V DC Driver (350mA Constant Current) Supplied with Remote Driver
Wall Mount Finish	Matte Black / Matte White / Brass Finish / Steel Finish / Medium Bronze Powdercoat	Dedicated LED	3 x 1W - (Standard) / 3 x 2W (additional cost) Lifespan - 60,000+ Hours CRI>90
Glass Dimensions	150mm Wall Mount: 110 x 15mm Protrudes: 90mm	Colour Temperature	2700K / 3000K (Standard) / 4000K
Overall Length	500mm	Dimming	TRIAC/Phase Dimmable (Standard) DALI (additional cost) Please contact for alternative dimming options
IP Rating	IP20 Indoor	Mounting	Integral Wall Bracket
Warranty	24 Months / 2 Years	Certification	AU/NZ AS/NZS 60598.1, 60598.2.1 EU EN 60598.1, 60598.2.1 US/CAN ETL/UL 1598, CSA C22.2#250.0

DIMENSIONS

MOUNTING

Glass Installation

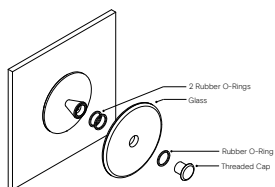

To install the glass piece, hold the glass against the LED housing and thread the 30mm threaded cap into the LED housing.
*Ensure the rubber o-rings are installed in the correct position, with 2 behind the glass and 1 in front on the glass. If the glass is not held firmly when the threaded cap is fully screwed in, install an extra o-ring in front of the glass.

Wall Plate Dimensions

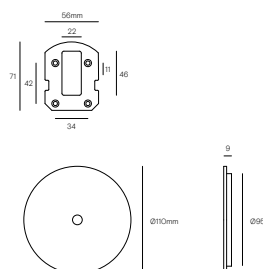

Installation Instructions

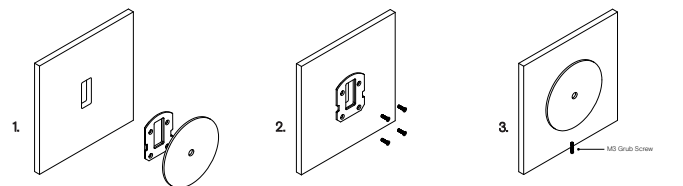

Prep the wall with a hole match the wall plate cutout. Secure the transformer into the wall cavity and feed the cable through the hole into the room. Connect the single electrified cable to the transformer.
*The transformer needs to be accessible for maintenance purposes.

Screw the mounting plate to the wall using appropriate fasteners for the wall substrate.

Fit the circular wall plate over the mounting plate and secure with the supplied M3 grub screw at the bottom of the plate.



SONN WALL LIGHT

Designed and Handmade by Oliver Höglund & Ryan Roberts

Illuminate your space with the Sonn wall light, a petite and elegant clear glass-blown fixture perfect for enhancing bathrooms, hallways, and kitchen areas. Created as an adaptation of the Sora wall light, its distinctive half-sphere design renders it a captivating focal point that exudes elegance from every perspective. Tailor it to your preferences by selecting a wall plate finish of brass finish, matte black, matte white, medium bronze or steel finish and set the mood of your space with a choice of warm, warm white, or white LED temperatures. Meticulously hand-blown using premium Swedish clear glass, each piece carries the distinctiveness of SOKTAS Glass designs, promising an unparalleled and personalised lighting masterpiece that adds both elegance and character to your space.

Hand-Blown in Currumbin, Australia



TECHNICAL DATA

Application	Interior Use (Optional: Outdoor Use) Low Voltage (under 12v)	Input Power	100-240V AC
Glass	Clear	Output Power	4V DC Driver (350mA Constant Current) Supplied with Remote Driver
Wall Plate Finish	Matte Black / Matte White / Brass Finish / Steel Finish / Medium Bronze Powdercoat	Dedicated LED	1W - 350mA (Standard) / 2W (additional cost) Lifespan - 60,000+ Hours CRI>90
Dimensions	Glass: 100 - 120mm Mounting Plate: 110 x 20mm Protudes: 80 - 100mm	Lumen Output	150lm (1W) (Standard) / 300lm (2W)
Weight	0.5kg	Colour Temperature	2700K / 3000K (Standard) / 4000K
IP Rating	IP20 Indoor (Optional: IP55 Outdoor)	Dimming	Triac-Dimmable (Standard) Optional: DALI (additional cost) Please contact for alternative dimming options
Warranty	24 Months / 2 Years	Mounting	Integral Wall Bracket
Certification	AU/NZ AS/NZS 60598.1, 60598.2.1 EU EN 60598.1, 60598.2.1 US/CAN ETL/UL 1598, CSA C22.2#250.0		

DIMENSIONS

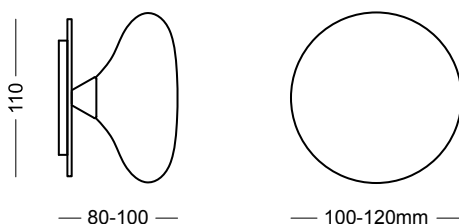

MOUNTING

Installation Instructions

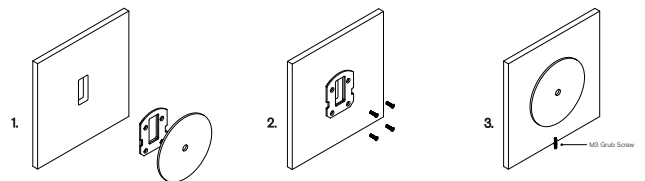

1. Prep the wall with an hole match the wall plate cutout. Secure the transformer into the wall cavity and feed the cable through the hole into the room. Connect the single electrified cable to the transformer.

2. Screw the mounting plate to the wall using appropriate fasteners for the wall substrate.

3. Fit the circular wall plate over the mounting plate and secure with the supplied M3 grub screw at the bottom of the plate.

*The transformer needs to be accessible for maintenance purposes.



CORAL TABLE LIGHT

Designed and Handmade by Oliver Höglund & Ryan Roberts

Enhance your desk or bedside tables with the Coral Table Lamp, an ideal addition to add a warm glow to your space. The organic stone base introduces a hint of natural elegance to your space, creating a captivating contrast against the metal lampholder, which comes in finishes of natural brass, medium bronze, or matte white. Set the mood of your space with a choice of warm, warm white, or white LED temperatures. Meticulously hand-blown using premium Swedish clear glass, each disc carries the distinctiveness of SOKTAS Glass designs, promising an unparalleled and personalised lighting masterpiece that adds both elegance and character to your space.

Hand Made in Currumbin, Australia.



TECHNICAL DATA

Application	Interior Use	Input Power	220-240V ---50/60HZ, 0.8Amax
Glass	Frosted	Output Power	24.0V---1.0A/24W
Lamp Rod Finish	Natural Brass / Matte White / Medium Bronze Powdercoat	Dedicated LED (x2)	1W - 350mA (Standard) / 2W (additional cost) Lifespan - 60,000+ Hours CRI>90
Lamp Base Finish	Travertine	Colour Temperature	2700K / 3000K (Standard) / 4000K
Glass Dimensions	2 x 120mm	Cord	White with in-line switch and AS/NZS Plug
Lamp Base	180 x 20mm	Overall Cord Length	2500mm
Overall Height	160mm	Certification	AS/NZS - 60598.2.1
Warranty	24 Months / 2 Years	IP Rating	IP20 Indoor

DIMENSIONS

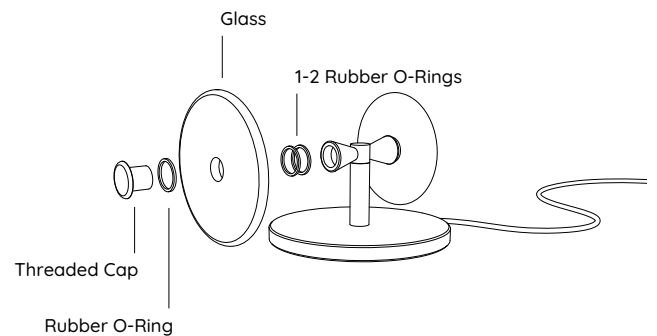
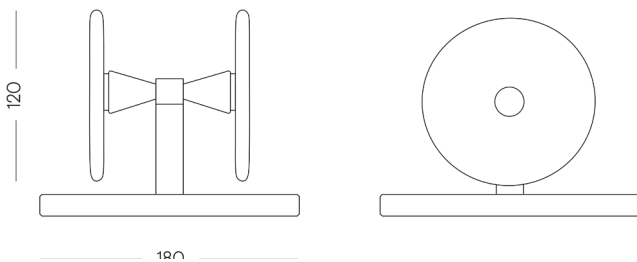



CORAL STONE WALL LIGHT

Designed and Handmade by Oliver Höglund & Ryan Roberts

Embellish your walls with the Coral Stone wall light, available in both clear and frosted finishes. This statement piece adds a modern contemporary feature ideal for kitchens, bedrooms, bathrooms and entryways. The incorporation of a natural stone back accentuates the distinctiveness of this piece with its authentic and organic essence. Tailor it to your preferences by selecting a cover cap finish of brass finish, matte black, matte white, medium bronze or steel finish and set the mood of your space with a choice of warm, warm white, or white LED temperatures. Meticulously hand-blown using premium Swedish clear glass, each disc carries the distinctiveness of SOKTAS Glass designs, promising an unparalleled and personalised lighting masterpiece that adds both elegance and character to your space.

Hand Made in Currumbin, Australia.



TECHNICAL DATA

Application	Interior & Outdoor Use	Input Power	100-240V AC
Glass	Frosted / Clear	Output Power	4V DC Driver (350mA Constant Current) Supplied with Remote Driver
Cover Cap Finish	Matte Black / Matte White / Brass Finish / Steel Finish / Medium Bronze Powdercoat	Dedicated LED	1W - 350mA (Standard) / 2W (additional cost) Lifespan - 60,000+ Hours CRI>90
Wall Mount Finish	Laminam Calce - Bianco	Colour Temperature	2700K / 3000K (Standard) / 4000K
Glass Dimensions	140mm Glass Thickness: 10-20mm	Dimming	Triac-Dimmable (Standard) Optional: DALI (additional cost) Please contact for alternative dimming options
Wall Mount:	180 x 20mm Protrudes: 50mm	Mounting	Integral Wall Bracket
IP Rating	IP65 Outdoor	Certification	AU/NZ AS/NZS 60598.1, 60598.2.1 EU EN 60598.1, 60598.2.1 US/CAN ETL/UL 1598, CSA C22.2#250.0
Warranty	24 Months / 2 Years		

GLASS INSTALLATION

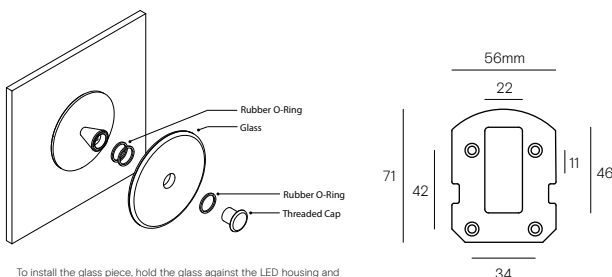

To install the glass piece, hold the glass against the LED housing and thread the 30mm threaded cap into the LED housing.
*Ensure the rubber o-rings are installed in the correct position, 1 behind the glass, and 1 in-front of the glass. If the glass is not held firmly when the threaded cap is fully screwed in, install an extra o-ring.

MOUNTING

Installation Instructions

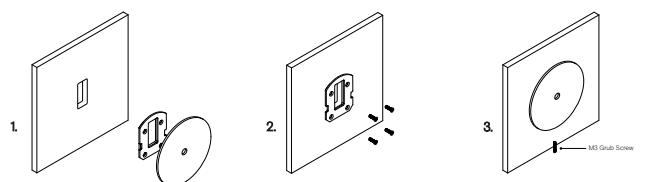

1. Prep the wall with an hole match the wall plate cutout. Secure the transformer into the wall cavity and feed the cable through the hole into the room. Connect the single electrified cable to the transformer.

2. Screw the mounting plate to the wall using appropriate fasteners for the wall substrate.

3. Fit the circular wall plate over the mounting plate and secure with the supplied M3 grub screw at the bottom of the plate.

*The transformer needs to be accessible for maintenance purposes.



CORAL TRAVERTINE WALL LIGHT

Designed and Handmade by Oliver Höglund & Ryan Roberts

Embellish your walls with the Coral Travertine wall light, available in both clear and frosted finishes. This statement piece adds a modern contemporary feature ideal for kitchens, bedrooms, bathrooms and entryways. The incorporation of a travertine back accentuates the distinctiveness of this piece with its authentic and organic essence. Tailor it to your preferences by selecting a cover cap finish of brass finish, matte black, matte white, medium bronze or steel finish and set the mood of your space with a choice of warm, warm white, or white LED temperatures. Meticulously hand-blown using premium Swedish clear glass, each disc carries the distinctiveness of SOKTAS Glass designs, promising an unparalleled and personalised lighting masterpiece that adds both elegance and character to your space.

Hand Made in Currumbin, Australia.



TECHNICAL DATA

Application	Interior & Outdoor Use	Input Power	100-240V AC
Glass	Frosted / Clear	Output Power	4V DC Driver (350mA Constant Current) Supplied with Remote Driver
Cover Cap Finish	Matte Black / Matte White / Brass Finish / Steel Finish / Medium Bronze Powdercoat	Dedicated LED	1W - 350mA (Standard) / 2W (additional cost) Lifespan - 60,000+ Hours CRI>90
Wall Mount Finish	Travertine	Colour Temperature	2700K / 3000K (Standard) / 4000K
Glass Dimensions	140mm Glass Thickness: 10-20mm	Dimming	Triac-Dimmable (Standard) Optional: DALI (additional cost) Please contact for alternative dimming options
Wall Mount:	180 x 20mm Protrudes: 50mm	Mounting	Integral Wall Bracket
IP Rating	IP65 Outdoor	Certification	AU/NZ AS/NZS 60598.1, 60598.2.1 EU EN 60598.1, 60598.2.1 US/CAN ETL/UL 1598, CSA C22.2#250.0
Warranty	24 Months / 2 Years		

DIMENSIONS

MOUNTING

Glass Installation

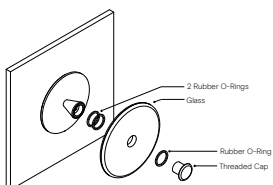

To install the glass piece, hold the glass against the LED housing and thread the 30mm threaded cap into the LED housing.

*Ensure the rubber o-rings are installed in the correct position, with 2 behind the glass and 1 in front on the glass. If the glass is not held firmly when the threaded cap is fully screwed in, install an extra o-ring in front of the glass.

Wall Plate Dimensions

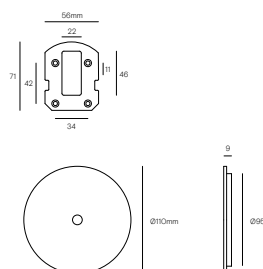

Installation Instructions

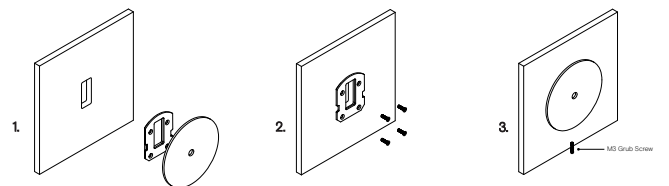

1. Prep the wall with a hole match the wall plate cutout. Secure the transformer into the wall cavity and feed the cable through the hole into the room. Connect the single electrified cable to the transformer.

2. Screw the mounting plate to the wall using appropriate fasteners for the wall substrate.

3. Fit the circular wall plate over the mounting plate and secure with the supplied M3 grub screw at the bottom of the plate.

*The transformer needs to be accessible for maintenance purposes.



OST PENDANT

Designed and Handmade by Oliver Höglund & Ryan Roberts

Bring a touch of modern minimalism into your space with the OST pendant light. Crafted in a hand-blown teardrop design, this light stands as a captivating focal point, perfect for solitary display or clustering over stairwells, dining tables, and kitchen islands. Effortlessly suspended by a steel cable, it connects through a sleek lampholder, available in finishes of brass finish, matte black, medium bronze, or steel finish. Tailor the atmosphere to your preference with a choice of warm, warm white, or white LED temperatures. Meticulously hand-blown using premium Swedish clear glass, each glass shade carries the distinctiveness of SOKTAS Glass designs, promising an unparalleled and personalised lighting masterpiece that adds both elegance and character to your space.

Hand-Blown in Currumbin, Australia.



TECHNICAL DATA

Application	Interior Use Only Low Voltage (under 12v)	Input Power	100-240VAC
Glass Colour	Clear	Output Power	4V DC Driver (350mA Constant Current) Supplied with Remote Driver
Lampholder Finish	Matte Black / Brass Finish / Steel Finish Matte White / Medium Bronze Powdercoat	LED Wattage	1W - 350mA (Standard) / 2W (additional cost) Lifespan - 60,000+ Hours CRI>90
Ceiling Mount	Matte Black / Matte White	Lumen Output	150lm (1W) (Standard) / 300lm (2W)
Dimensions	Height: 120-180mm Width: 80-90mm	Colour Temperature	2700K / 3000K (Standard) / 4000K
Cord	Steel / Black / White Cable 1500mm (Standard) Longer lengths on request	Dimming	Triac-Dimmable (Standard) Optional: DALI (additional cost) Please contact for alternative dimming options
Weight	0.6 - 0.8kg	Mounting	81mm Flat disc recessed ceiling plate Custom designed ceiling plate on request
Warranty	24 Months / 2 Years		
Certification	AU/NZ AS/NZS 60598.1, 60598.2.1 EU EN 60598.1, 60598.2.1 US/CAN ETL/UL 1598, CSA C22.2#250.0		

DIMENSIONS

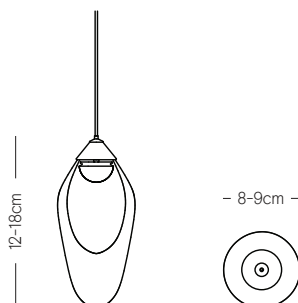

MOUNTING

Installation Instructions

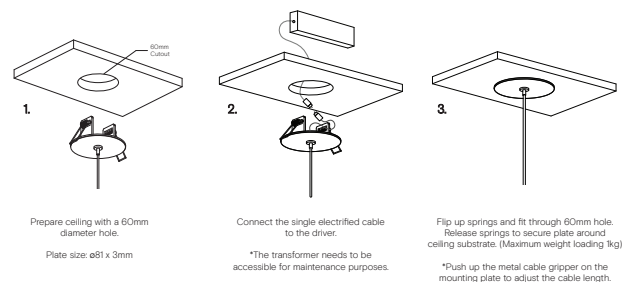



CORAL TWIN WALL LIGHT

Designed and Handmade by Oliver Höglund & Ryan Roberts

Embellish your walls with the Coral twin wall light, available in both clear and frosted finishes. This statement piece adds a modern contemporary feature ideal for kitchens, bedrooms, bathrooms and entryways. Tailor it to your preferences by selecting a wall plate finish of matte black, matte white or medium bronze and set the mood of your space with a choice of warm, warm white, or white LED temperatures. Meticulously hand-blown using premium Swedish clear glass, each disc carries the distinctiveness of SOKTAS Glass designs, promising an unparalleled and personalised lighting masterpiece that adds both elegance and character to your space.

Hand Made in Currumbin, Australia.



TECHNICAL DATA

Application	Interior & Outdoor Use	Input Power	100-240V AC
Glass	Frosted / Clear	Output Power	7V DC Driver (350mA Constant Current) Supplied with Remote Driver
Wall Mount Finish	Matte Black / Matte White / Medium Bronze	Dedicated LED	1W - 350mA (Standard) / 2W (additional cost) Lifespan - 60,000+ Hours CRI>90
Glass Dimensions	2 x 120mm Wall Mount: 110 x 15mm Protrudes: 120mm	Colour Temperature	2700K / 3000K (Standard) / 4000K
IP Rating	IP65	Dimming	Triac-Dimmable (Standard) Optional: DALI (additional cost) Please contact for alternative dimming options
Warranty	24 Months / 2 Years	Mounting	Integral Wall Bracket
		Certification	AU/NZ AS/NZS 60598.1, 60598.2.1 EU EN 60598.1, 60598.2.1 US/CAN ETL/UL 1598, CSA C22.2#250.0

DIMENSIONS

Glass Installation

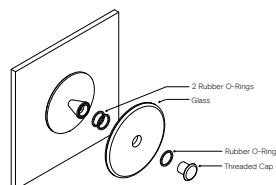

To install the glass piece, hold the glass against the LED housing and thread the 30mm threaded cap into the LED housing.

*Ensure the rubber o-rings are installed in the correct position, with 2 behind the glass and 1 in front on the glass. If the glass is not held firmly when the threaded cap is fully screwed in, install an extra o-ring in front of the glass.

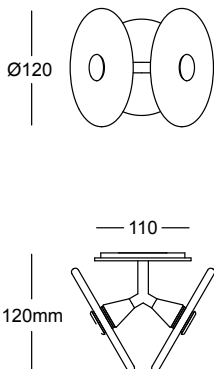

MOUNTING

Installation Instructions

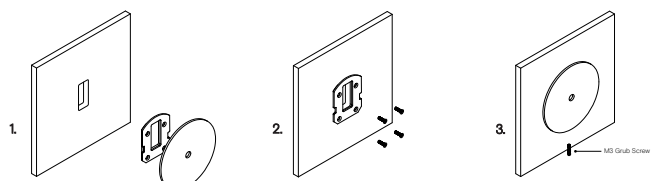

Prep the wall with a hole match the wall plate cutout. Secure the transformer into the wall cavity and feed the cable through the hole into the room. Connect the single electrified cable to the transformer.

Screw the mounting plate to the wall using appropriate fasteners for the wall substrate.

Fit the circular wall plate over the mounting plate and secure with the supplied M3 grub screw at the bottom of the plate.

*The transformer needs to be accessible for maintenance purposes.



CORAL

LINEAR ROD PENDANT (x7)

Designed and Handmade by Oliver Höglund & Ryan Roberts

Elevate your space with the Coral Linear Rod pendant light, a captivating modern centrepiece perfect for dining spaces and over kitchen islands. Seven exquisite glass-blown discs are suspended from a beautiful crafted rod structure, available in a selection of finishes including natural brass, steel finish, matte black, matte white, or medium bronze powder coating. Choose from a frosted or clear finish and set the mood of your space with a choice of warm, warm white, or white LED temperatures. Meticulously hand-blown using premium Swedish clear glass, each disc carries the distinctiveness of SOKTAS Glass designs, promising an unparalleled and personalised lighting masterpiece that adds both elegance and character to your space.

Hand Made in Currumbin, Australia.



TECHNICAL DATA

Application	Interior Use Only	Input Power	100 - 240VAC
Glass Colour	Frosted / Clear	Output Voltage (Standard)	17-19V DC Driver (350mA Constant Current) Supplied with Remote Driver
Rod Suspensions	Natural Brass / Matte Black / Matte White / Steel Finish / Medium Bronze Powdercoat	Dedicated LED	7 x 1W - 350mA (Standard) Lifespan - 60,000+ Hours CRI>90
Ceiling Canopy	Natural Brass / Matte Black / Matte White / Steel Finish / Medium Bronze Powdercoat	Colour Temperature	2700K / 3000K (Standard) / 4000K
Dimensions	Glass Diameter: 170mm Linear Rod: 1500mm	Dimming	TRIAC/Phase Dimmable (Standard) Dimmable DALI (additional cost) Please contact for alternative dimming
Measurement between vertical rods	740mm	Warranty	24 Months / 2 Years
Certification	AU/NZ AS/NZS 60598.1, 60598.2.1 EU EN 60598.1, 60598.2.1 US/CAN ETL/UL 1598, CSA C22.2#250.0		

DIMENSIONS

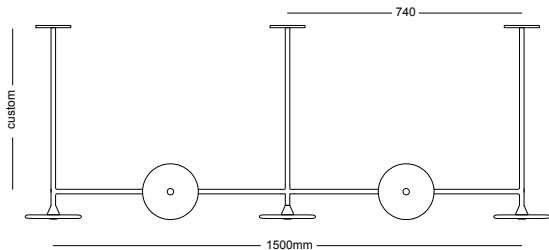

MOUNTING

Installation Instructions

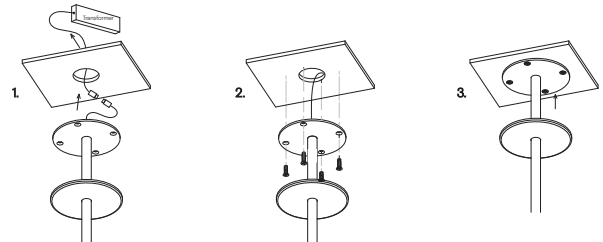

Prep the ceiling with an approx. 50mm hole to fit the transformer. Place the transformer in the ceiling and feed the cable through the hole into the room. Connect the single electrified cable to the transformer.

Screw the steel mounting plate to the ceiling using appropriate fasteners for the ceiling substrate.

Secure the magnetic cover plate onto the mounting plate.

*The transformer needs to be accessible for maintenance purposes.



CORAL

LINEAR ROD PENDANT (x10)

Designed and Handmade by Oliver Höglund & Ryan Roberts

Elevate your space with the Coral Linear Rod pendant light, a captivating modern centrepiece perfect for dining spaces and over kitchen islands. Ten exquisite glass-blown discs are suspended from a beautiful crafted rod structure, available in a selection of finishes including natural brass, steel finish, matte black, matte white, or medium bronze powder coating. Choose from a frosted or clear finish and set the mood of your space with a choice of warm, warm white, or white LED temperatures. Meticulously hand-blown using premium Swedish clear glass, each disc carries the distinctiveness of SOKTAS Glass designs, promising an unparalleled and personalised lighting masterpiece that adds both elegance and character to your space.

Hand Made in Currumbin, Australia.



TECHNICAL DATA

Application	Interior Use Only	Input Power	100 - 240VAC
Glass Colour	Frosted / Clear	Output Voltage (Standard)	17-19V DC Driver (350mA Constant Current) Supplied with Remote Driver
Rod Suspensions	Natural Brass / Matte Black / Matte White / Steel Finish / Medium Bronze Powdercoat	Dedicated LED	10 x 1W - 350mA (Standard) Lifespan - 60,000+ Hours CRI>90
Ceiling Canopy	Natural Brass / Matte Black / Matte White / Steel Finish / Medium Bronze Powdercoat	Colour Temperature	2700K / 3000K (Standard) / 4000K
Dimensions	Glass Diameter: 170mm Linear Rod: 1500mm	Dimming	TRIAC/Phase Dimmable (Standard) Dimmable DALI (additional cost) Please contact for alternative dimming
Measurement between vertical rods	750mm	Warranty	24 Months / 2 Years
Certification	AU/NZ AS/NZS 60598.1, 60598.2.1 EU EN 60598.1, 60598.2.1 US/CAN ETL/UL 1598, CSA C22.2#250.0		

DIMENSIONS

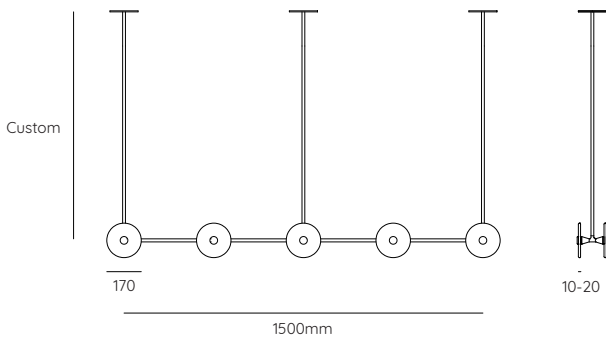

MOUNTING

Installation Instructions

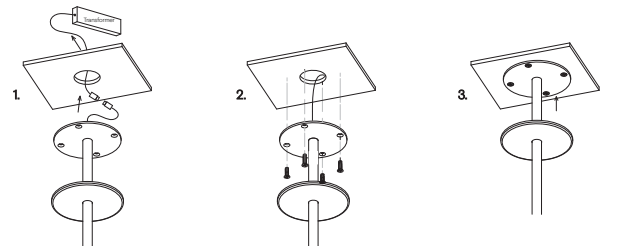

Prep the ceiling with an approx. 50mm hole to fit the transformer. Place the transformer in the ceiling and feed the cable through the hole into the room. Connect the single electrified cable to the transformer.

Screw the steel mounting plate to the ceiling using appropriate fasteners for the ceiling substrate.

Secure the magnetic cover plate onto the mounting plate.

*The transformer needs to be accessible for maintenance purposes.



CORAL

LINEAR BAR PENDANT

Designed and Handmade by Oliver Höglund & Ryan Roberts

Add a feature piece to your space with the Coral Linear Bar pendant light, a beautiful modern centrepiece perfect for dining tables, kitchen islands and elegant office spaces. Featuring ten unique glass-blown discs suspended on a rod available in a selection of finishes including brass finish, steel finish, matte black, matte white, or medium bronze powder coating. Choose from a frosted or clear finish and set the mood of your space with a choice of warm, warm white, or white LED temperatures. Meticulously hand-blown using premium Swedish clear glass, each disc carries the distinctiveness of SOKTAS Glass designs, promising an unparalleled and personalised lighting masterpiece that adds both elegance and character to your space.

Hand Made in Currumbin, Australia.



TECHNICAL DATA

Application	Interior Use Only	Input Power	100 - 240VAC
Glass Colour	Frosted / Clear	Output Power Standard	17 - 29V DC (350mA Constant Current) Supplied with Remote Driver
Linear Bar Finish	Matte Black / Matte White / Steel Finish / Brass Finish / Medium Bronze Powdercoat	Dedicated LED	10 x 1W - 350mA (Standard) 10 x 2W - 350mA (additional cost) Lifespan - 60,000+ Hours CRI>90
Ceiling Mount	Matte White / Matte Black	Colour Temperature	2700K / 3000K (standard) / 4000K
Suspension	Steel Cable / Black Cable / White Cable	Dimming	Yes - TRIAC / Phase Dimming (Standard) DALI Dimmable (additional cost) Please contact for alternative dimming
Suspension Length	1500mm	Warranty	24 Months / 2 Years
Dimensions	Coral Glass (x10) Width: 150mm Linear Bar Length: 1500mm Total width - 110mm - 120mm Weight: 6.0kg	Certification	AU/NZ AS/NZS 60598.1, 60598.2.1 EU EN 60598.1, 60598.2.1 US/CAN ETL/UL 1598, CSA C22.2#250.0
Measurement between ceiling mounts - 1330mm			

DIMENSIONS

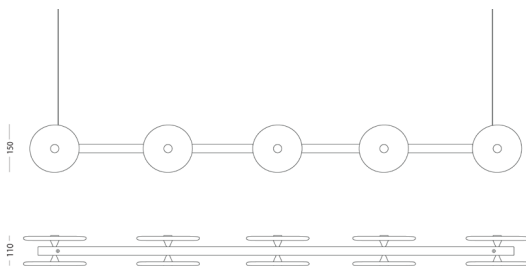

MOUNTING

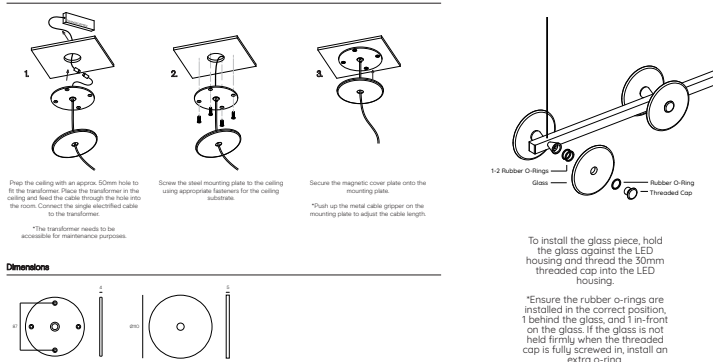



CORAL

LINEAR BAR WITH ROD PENDANT

Designed and Handmade by Oliver Höglund & Ryan Roberts

Add a feature piece to your space with the Coral Linear Bar pendant light, a beautiful modern centrepiece perfect for dining tables, kitchen islands and elegant office spaces. Featuring ten unique glass-blown discs suspended on a rod available in a selection of finishes including brass finish, steel finish, matte black, matte white, or medium bronze powder coating. Choose from a frosted or clear finish and set the mood of your space with a choice of warm, warm white, or white LED temperatures. Meticulously hand-blown using premium Swedish clear glass, each disc carries the distinctiveness of SOKTAS Glass designs, promising an unparalleled and personalised lighting masterpiece that adds both elegance and character to your space.

Hand Made in Currumbin, Australia.



TECHNICAL DATA

Application	Interior Use Only	Input Power	100 - 240VAC
Glass Colour	Frosted / Clear	Output Power Standard	17 - 29V DC (350mA Constant Current) Supplied with Remote Driver
Linear Bar Finish	Matte Black / Matte White / Steel Finish / Brass Finish / Medium Bronze Powdercoat	Dedicated LED	10 x 1W - 350mA (Standard) 10 x 2W - 350mA (additional cost) Lifespan - 60,000+ Hours CRI>90
Ceiling Mount	Matte White / Matte Black	Colour Temperature	2700K / 3000K (standard) / 4000K
Suspension	Steel Cable / Black Cable / White Cable	Dimming	Yes - TRIAC / Phase Dimming (Standard) DALI Dimmable (additional cost) Please contact for alternative dimming
Suspension Length	1500mm	Warranty	24 Months / 2 Years
Dimensions	Coral Glass (x10) Width: 150mm Linear Bar Length: 1500mm Total width - 110mm - 120mm Weight: 6.0kg	Certification	AU/NZ AS/NZS 60598.1, 60598.2.1 EU EN 60598.1, 60598.2.1 US/CAN ETL/UL 1598, CSA C22.2#250.0
Measurement between ceiling mounts: 1050mm			

DIMENSIONS

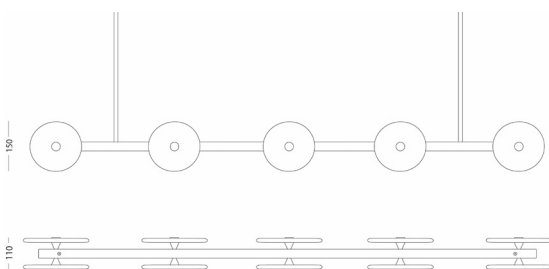

MOUNTING

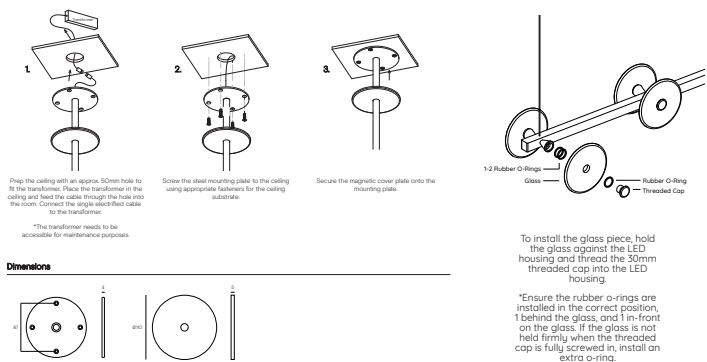



CORAL

RING PENDANT (20 PIECES)

Designed and Handmade by Oliver Höglund & Ryan Roberts

Adorn your space with the remarkable Coral Ring 20 Piece pendant light. The circular ring base, available in a brass finish, matte black, matte white, and medium bronze finishes provides a striking canvas for the arrangement of 20 individual hand-blown glass discs. The interplay of varied glass sizes imparts a distinctive touch of opulence to this centerpiece, making it an ideal choice for hanging above dining tables, kitchen islands, or within an office space. Choose from a frosted or clear finish and set the mood of your space with a choice of warm, warm white, or white LED temperatures. Meticulously hand-blown using premium Swedish clear glass, each disc carries the distinctiveness of SOKTAS Glass designs, promising an unparalleled and personalised lighting masterpiece that adds both elegance and character to your space.

Hand Made in Currumbin, Australia.



TECHNICAL DATA

Application	Interior Use Only	Input Power	100 - 240VAC
Glass Colour	Frosted / Clear	Output Power Standard	17 - 29V DC (350mA Constant Current) Supplied with Remote Driver
Round Bar Finish	Brass Finish / Matte Black / Matte White / Medium Bronze Powdercoat	Dedicated LED	10 x 1W 350mA (Standard) 10 x 2W 350mA (additional cost) Lifespan - 60,000+ Hours CRI>90
Ceiling Mount	Matte White / Matte Black	Colour Temperature	2700K / 3000K (standard) / 4000K
Suspension	Steel Cable / Black Cable / White Cable	Dimming	Yes - TRIAC / Phase Dimming (Standard) Dimmable DALI (additional cost)
Suspension Length	1500mm (Or custom length)	Warranty	24 Months / 2 Years
Glass Dimensions	Coral Glass Width: (x10) 120mm & (x10) 150mm	Certification	AU/NZ AS/NZS 60598.1, 60598.2.1 EU EN 60598.1, 60598.2.1 US/CAN ETL/UL 1598, CSA C22.2#250.0
Ring Diameter	800mm		
Weight	10kg		

MOUNTING

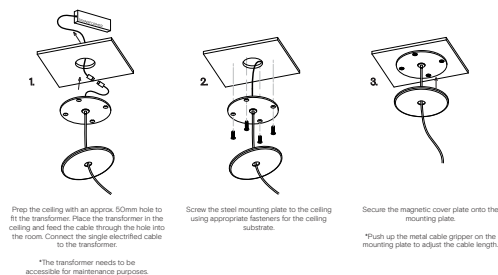

Dimensions

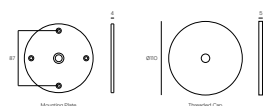

Glass Installation

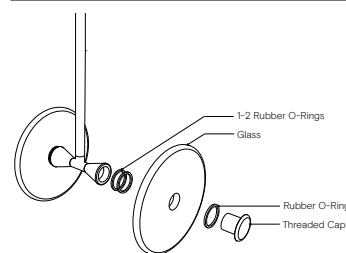

To install the glass piece, hold the glass against the LED housing and thread the 30mm threaded cap into the LED housing.

*Ensure the rubber o-rings are installed in the correct position, 1 behind the glass, and 1 in-front on the glass. If the glass is not held firmly when the threaded cap is fully screwed in, install an extra o-ring.

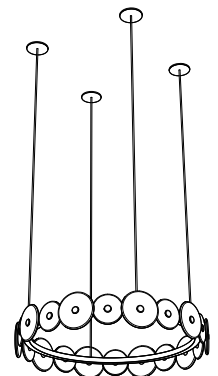



CORAL

RING PENDANT (10 PIECES)

Designed and Handmade by Oliver Höglund & Ryan Roberts

Adorn your space with the remarkable Coral Ring 10 Pieces pendant light. The circular ring base, available in a brass finish, matte black, matte white, and medium bronze finishes provides a striking canvas for the arrangement of ten individual hand-blown glass discs. This ring of modern art adds a distinctive touch of opulence to any space, particularly suited for hanging above dining tables, kitchen islands, or within an office space. Choose from a frosted or clear finish and set the mood of your space with a choice of warm, warm white, or white LED temperatures. Meticulously hand-blown using premium Swedish clear glass, each disc carries the distinctiveness of SOKTAS Glass designs, promising an unparalleled and personalised lighting masterpiece that adds both elegance and character to your space.

Hand Made in Currumbin, Australia.



TECHNICAL DATA

Application	Interior Use Only	Input Power	100 - 240VAC
Glass Colour	Frosted / Clear	Output Power Standard	17 - 29V DC (350mA Constant Current) Supplied with Remote Driver
Round Bar Finish	Brass Finish / Matte Black / Matte White / Medium Bronze Powdercoat	Dedicated LED	10 x 1W 350mA (Standard) 10 x 2W 350mA (additional cost) Lifespan - 60,000+ Hours CRI>90
Cover Cap Finish:	Brass Finish / Matte Black / Matte White / Steel Finish / Medium Bronze Powdercoat	Colour Temperature	2700K / 3000K (standard) / 4000K
Ceiling Mount	Matte White / Matte Black	Dimming	Yes - TRIAC / Phase Dimming (Standard) Dimmable DALI (additional cost)
Suspension	White Cable / Steel Cable / Black Cable	Warranty	24 Months / 2 Years
Suspension Length	1500mm (Or custom length)	Certification	AU/NZ AS/NZS 60598.1, 60598.2.1 EU EN 60598.1, 60598.2.1 US/CAN ETL/UL 1598, CSA C22.2#250.0
Glass Dimensions	Coral Glass (x10) Width: 150 - 170mm		
Ring Diameter	800mm		
Weight	8kg		

MOUNTING

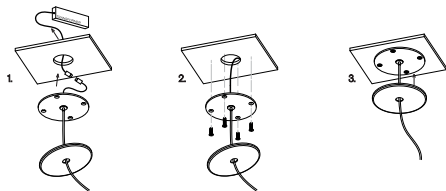

1. Prep the ceiling with an approx. 50mm hole to fit the transformer. Place the transformer in the ceiling and feed the cable through the hole into the room. Connect the single electrified cable to the transformer.
*The transformer needs to be accessible for maintenance purposes.

2. Screw the steel mounting plate to the ceiling using appropriate fasteners for the ceiling substrate.

3. Secure the magnetic cover plate onto the mounting plate.
*Push up the metal cable gripper on the mounting plate to adjust the cable length.

Dimensions

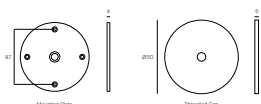

Glass Installation

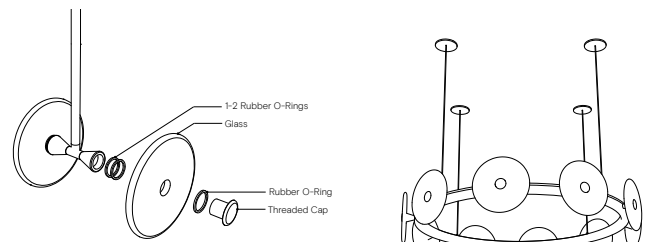

To install the glass piece, hold the glass against the LED housing and thread the 30mm threaded cap into the LED housing.

*Ensure the rubber o-rings are installed in the correct position, 1 behind the glass, and 1 in-front on the glass. If the glass is not held firmly when the threaded cap is fully screwed in, install an extra o-ring.



CORAL DOME WALL LIGHT

Designed and Handmade by Oliver Höglund & Ryan Roberts

Illuminate your space with the Coral Dome wall light, a sophisticated clear glass-blown fixture designed to elevate entryways, hallways, and kitchen spaces. The incorporation of the sleek dome back makes this piece a modern feature point. Tailor it to your preferences by selecting a dome finish of matte black, matte white or medium bronze, and set the mood of your space with a choice of warm, warm white, or white LED temperatures. Meticulously hand-blown using premium Swedish clear glass, each disc carries the distinctiveness of SOKTAS Glass designs, promising an unparalleled and personalised lighting masterpiece that adds both elegance and character to your space.

Hand Made in Currumbin, Australia.



TECHNICAL DATA

Application	Interior & Outdoor Use	Input Power	100-240V AC
Glass	Frosted / Clear	Output Power	4V DC Driver (350mA Constant Current) Supplied with Remote Driver
Steel Dome Finish	Matt White / Matte White / Medium Bronze	Dedicated LED	1W - 350mA (Standard) / 2W (additional cost) Lifespan - 60,000+ Hours CRI>90
Glass Dimensions	160mm Glass Thickness: 10-20mm	Colour Temperature	2700K / 3000K (Standard) / 4000K
Wall Mount (Dome):	260mm Protrudes: 50mm	Dimming	Triac-Dimmable (Standard) Optional: DALI (additional cost) Please contact for alternative dimming options
IP Rating	IP65 Outdoor	Mounting	Integral Wall Bracket
Warranty	24 Months / 2 Years		
Certification	AU/NZ AS/NZS 60598.1, 60598.2.1 EU EN 60598.1, 60598.2.1 US/CAN ETL/UL 1598, CSA C22.2#250.0		

DIMENSIONS

MOUNTING

Glass Installation

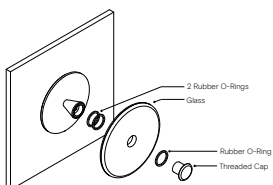

To install the glass piece, hold the glass against the LED housing and thread the 30mm threaded cap into the LED housing.
*Ensure the rubber o-rings are installed in the correct position, with 2 behind the glass and 1 in front on the glass. If the glass is not held firmly when the threaded cap is fully screwed in, install an extra o-ring in front of the glass.

Wall Plate Dimensions

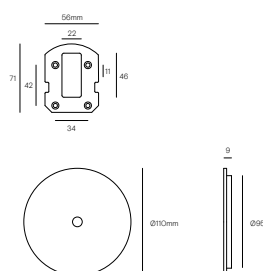

Installation Instructions

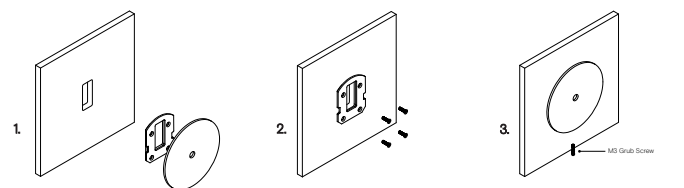

Prep the wall with a hole match the wall plate cutout. Secure the transformer into the wall cavity and feed the cable through the hole into the room. Connect the single electrified cable to the transformer.

Screw the mounting plate to the wall using appropriate fasteners for the wall substrate.

Fit the circular wall plate over the mounting plate and secure with the supplied M3 grub screw at the bottom of the plate.

*The transformer needs to be accessible for maintenance purposes.



CORAL DUO DOME PENDANT

Designed and Handmade by Oliver Höglund & Ryan Roberts

Add a touch of sophistication to your space with the Coral Duo Dome pendant light. Its distinctive layered dome design transforms this pendant light into a modern art piece exquisitely tailored to elevate dining spaces, bedrooms, and refined office spaces. Featuring a hand-blown glass shade and two steel domes available in matte black, matte white or medium brown finishes, this pendant will set the mood of your choice of warm, warm white, or white LED temperatures. Meticulously hand-blown using premium Swedish clear glass, each disc carries the distinctiveness of SOKTAS Glass designs, promising an unparalleled and personalised lighting masterpiece that adds both elegance and character to your space.

Hand Made in Currumbin, Australia.



TECHNICAL DATA

Application	Interior Use Only Low Voltage (under 12v)	Input Power	100 - 240V AC
Glass Colour	Frosted / Clear	Output Voltage	4V DC Driver (350mA Constant Current) Supplied with Remote Driver
Steel Dome Finish	Matte White / Matte Black / Medium Bronze	Dedicated LED	2W - 350mA (Standard) Lifespan - 60,000+ Hours CRI>90
Ceiling Mount	Matte White / Matte Black	Colour Temperature	2700K / 3000K (Standard) / 4000K
Glass Dimensions	160 - 180mm (approx.)	Dimming	2W LED - Triac-Dimmable (Standard) DALI (additional cost) Please contact for other dimming options
Dome Dimensions	450mm external / 260mm internal	Mounting	110mm Flat disc recessed ceiling plate Custom designed ceiling plate on request
Suspension	1500mm White Cable / Steel Cable / Black Cable Longer lengths on request	Certification	AU/NZ AS/NZS 60598.1, 60598.2.1 EU EN 60598.1, 60598.2.1 US/CAN ETL/UL 1598, CSA C22.2#250.0
Weight	1.5kg		
Warranty	24 Months / 2 Years		

DIMENSIONS

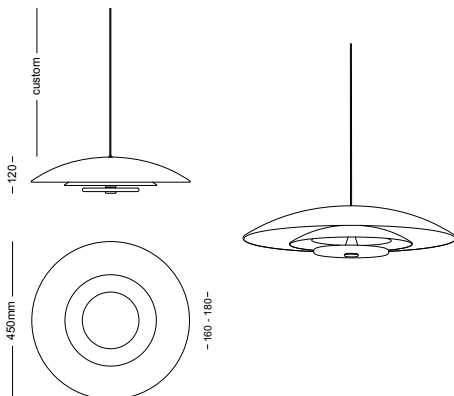

MOUNTING

Installation Instructions

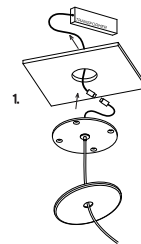

Prep the ceiling with an approx. 50mm hole to fit the transformer. Place the transformer in the ceiling and feed the cable through the hole into the room. Connect the single electrified cable to the transformer.

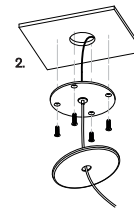

Screw the steel mounting plate to the ceiling using appropriate fasteners for the ceiling substrate.

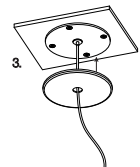

Secure the magnetic cover plate onto the mounting plate.

*Push up the metal cable gripper on the mounting plate to adjust the cable length.



CORAL DOME PENDANT

Designed and Handmade by Oliver Höglund & Ryan Roberts

Infuse a touch of elegance into your surroundings with the Coral Dome pendant light. The unique dome configuration metamorphoses this pendant into a contemporary masterpiece, meticulously designed to enrich dining areas, bedrooms, and upscale office settings. Featuring a hand-blown glass shade and a steel dome in options of matte black, matte white, or medium brown finishes, this pendant provides the perfect ambience through your preference of warm, warm white, or white LED temperatures. Meticulously hand-blown using premium Swedish clear glass, each disc carries the distinctiveness of SOKTAS Glass designs, promising an unparalleled and personalised lighting masterpiece that adds both elegance and character to your space.

Hand Made in Currumbin, Australia.



TECHNICAL DATA

Application	Interior Use Only Low Voltage (under 12v)	Input Power	100 - 240V AC
Glass Colour	Frosted / Clear	Output Voltage	4V DC Driver (350mA Constant Current) Supplied with Remote Driver
Steel Dome Finish	Matte White / Matte Black / Medium Bronze	Dedicated LED	2W - 350mA (Standard) Lifespan - 60,000+ Hours CRI>90
Ceiling Mount	Matte White / Matte Black	Colour Temperature	2700K / 3000K (Standard) / 4000K
Glass Dimensions	160 - 180mm (approx.)	Dimming	2W LED - Triac-Dimmable (Standard) DALI (additional cost) Please contact for other dimming options
Dome Dimensions	260mm width	Mounting	110mm Flat disc recessed ceiling plate Custom designed ceiling plate on request
Suspension	1500mm White Cable / Black Cable Longer lengths on request	Certification	AU/NZ AS/NZS 60598.1, 60598.2.1 EU EN 60598.1, 60598.2.1 US/CAN ETL/UL 1598, CSA C22.2#250.0
Weight	0.5kg		
Warranty	24 Months / 2 Years		

DIMENSIONS

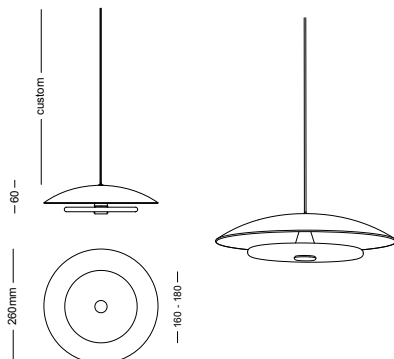

MOUNTING

Installation Instructions

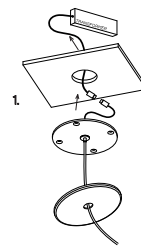

Prep the ceiling with an approx. 50mm hole to fit the transformer. Place the transformer in the ceiling and feed the cable through the hole into the room. Connect the single electrified cable to the transformer.

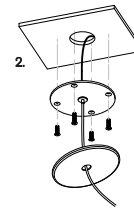

Screw the steel mounting plate to the ceiling using appropriate fasteners for the ceiling substrate.

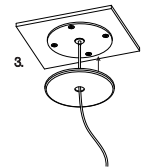

Secure the magnetic cover plate onto the mounting plate.

*Push up the metal cable gripper on the mounting plate to adjust the cable length.



CORAL

SINGLE ROD PENDANT

Designed and Handmade by Oliver Höglund & Ryan Roberts

Elevate your space with the Coral Single pendant light, a captivating modern centrepiece perfect for entryways, bathrooms, and kitchen islands. One exquisite glass-blown disc is elegantly suspended from a rod, available in a selection of finishes including natural brass, steel finish, matte black, matte white, or medium bronze powder coating. Available in fixed or adjustable ceiling installation, opt for frosted or clear glass to match your style and set the mood with a choice of warm, warm white, or white LED temperatures. Meticulously hand-blown using premium Swedish clear glass, each disc carries the distinctiveness of SOKTAS Glass designs, promising an unparalleled and personalised lighting masterpiece that adds both elegance and character to your space.

Hand Made in Currumbin, Australia.



TECHNICAL DATA

Application	Interior Use Only	Input Power	100 - 240VAC
Glass Colour	Frosted / Clear	Output Voltage	4V DC Driver (350mA Constant Current) Supplied with Remote Driver
Suspension Rod	Natural Brass / Matte Black / Matte White / Steel Finish / Medium Bronze Powdercoated	Dedicated LED	2W - 350mA (Standard) Lifespan - 60,000+ Hours CRI>90
Glass Diameter	Small: 120 - 140mm Medium: 150 - 170mm Large: 200 - 220mm	Colour Temperature	2700K / 3000K (Standard) / 4000K
Rod Length	1200mm (custom lengths available)	Dimming	2W LED - Triac-Dimmable (Standard) DALI (additional cost) Please contact for other dimming options
Certification	AU/NZ AS/NZS 60598.1, 60598.2.1 EU EN 60598.1, 60598.2.1 US/CAN ETL/UL 1598, CSA C22.2#250.0	Warranty	24 Months / 2 Years

DIMENSIONS

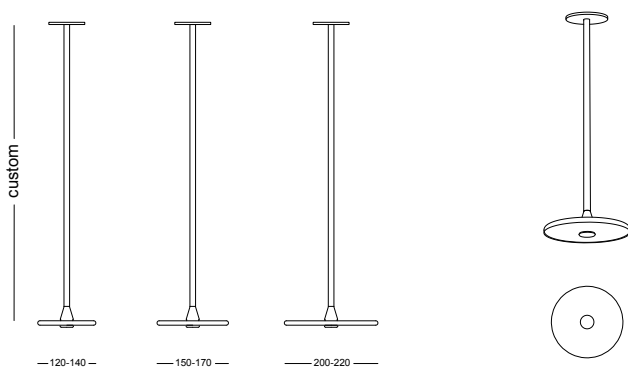

MOUNTING

Installation Instructions

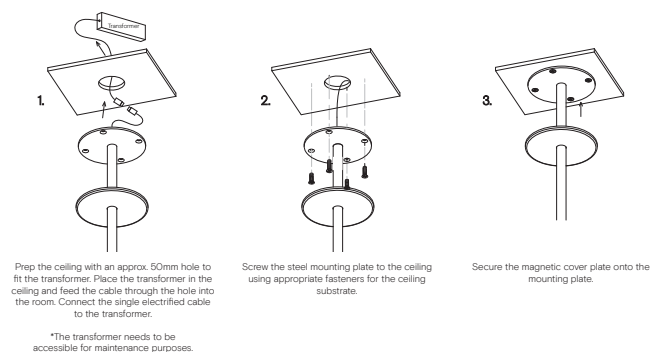



CORAL DUO PENDANT

Designed and Handmade by Oliver Höglund & Ryan Roberts

Elevate your space with the Coral Duo pendant light, a captivating modern centrepiece perfect for entryways, bathrooms, and kitchen islands. Two exquisite glass-blown discs are elegantly suspended from a rod, available in a selection of finishes including natural brass, steel finish, matte black, matte white, or medium bronze powder coating. Available in fixed or adjustable ceiling installation, opt for frosted or clear glass to match your style and set the mood with a choice of warm, warm white, or white LED temperatures. Meticulously hand-blown using premium Swedish clear glass, each disc carries the distinctiveness of SOKTAS Glass designs, promising an unparalleled and personalised lighting masterpiece that adds both elegance and character to your space.

Hand Made in Currumbin, Australia.



TECHNICAL DATA

Application	Interior Use Only	Input Power	100 - 240VAC
Glass Colour	Frosted / Clear	Output Voltage Standard	4V DC Driver (350mA Constant Current) Supplied with Remote Driver
Suspension Rod	Natural Brass / Matte Black / Matte White / Steel Finish / Medium Bronze Powdercoated	Dedicated LED	2 x 1W - 350mA (Standard) 2 x 2W - 350mA (additional cost) Lifespan - 60,000+ Hours CRI>90
Glass Diameter	Small: 120 - 140mm Medium: 150 - 170mm Large: 200 - 220mm	Colour Temperature	2700K / 3000K (Standard) / 4000K
Rod Length	1200mm (custom lengths available)	Dimming	Yes - Dimmable TRIAC/Phase (Standard) Dimmable DALI (additional cost) Please contact for alternative dimming
Certification	AU/NZ AS/NZS 60598.1, 60598.2.1 EU EN 60598.1, 60598.2.1 US/CAN ETL/UL 1598, CSA C22.2#250.0	Warranty	24 Months / 2 Years

DIMENSIONS

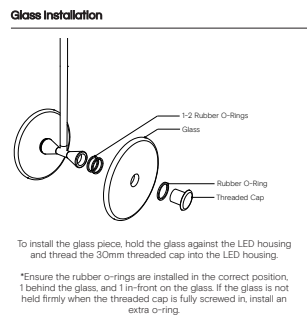
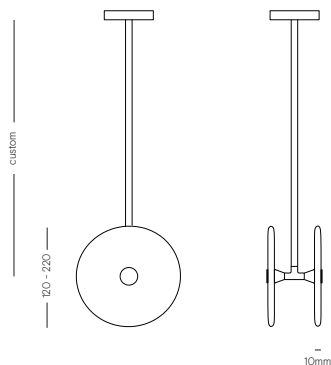

MOUNTING

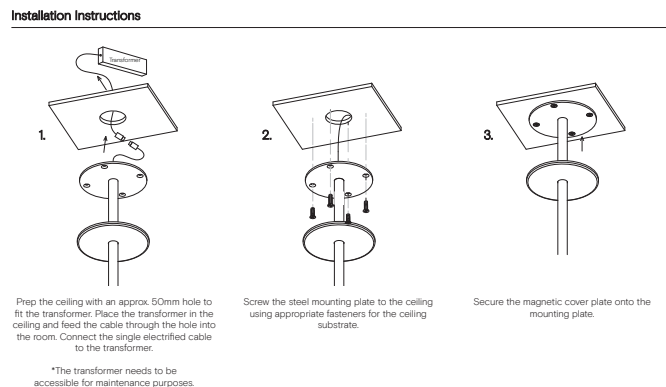



CORAL

TRIO PENDANT - CENTERED

Designed and Handmade by Oliver Höglund & Ryan Roberts

Elevate your space with the Coral Trio pendant light, a captivating modern centrepiece perfect for entryways, bathrooms, and kitchen islands. Three exquisite glass-blown discs are elegantly suspended from a rod, available in a selection of finishes including natural brass, steel finish, matte black, matte white, or medium bronze powder coating. Available in a centred or off-centred installation, opt for frosted or clear glass to match your style and set the mood with a choice of warm, warm white, or white LED temperatures. Meticulously hand-blown using premium Swedish clear glass, each disc carries the distinctiveness of SOKTAS Glass designs, promising an unparalleled and personalised lighting masterpiece that adds both elegance and character to your space.

Hand Made in Currumbin, Australia.



TECHNICAL DATA

Application	Interior Use Only	Input Power	100 - 240VAC
Glass Colour	Frosted / Clear	Output Voltage Standard	4V DC Driver (350mA Constant Current) Supplied with Remote Driver
Suspension Rod	Natural Brass / Matte Black / Matte White / Steel Finish / Medium Bronze Powdercoat	Dedicated LED	3 x 1W - 350mA (Standard) 3 x 2W - 350mA (additional cost) Lifespan - 60,000+ Hours CRI>90
Glass Diameter	Small: 120 - 140mm Medium: 150 - 170mm Large: 200 - 220mm	Colour Temperature	2700K / 3000K (Standard) / 4000K
Rod Length	1200mm (custom lengths available)	Dimming	Yes - Dimmable TRIAC/Phase (Standard) Dimmable DALI (additional cost) Please contact for alternative dimming
Certification	AU/NZ AS/NZS 60598.1, 60598.2.1 EU EN 60598.1, 60598.2.1 US/CAN ETL/UL 1598, CSA C22.2#250.0	Warranty	24 Months / 2 Years

DIMENSIONS

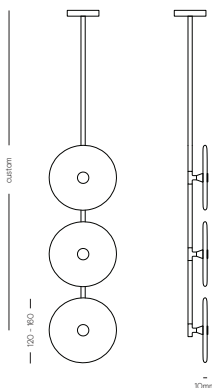

Glass Installation

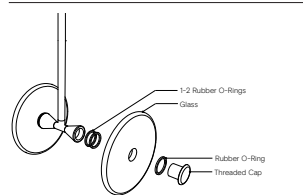

To install the glass piece: hold the glass against the LED housing and thread the 50mm threaded cap into the LED housing.
*Ensure the rubber o-rings are installed in the correct position, 1 behind the glass, and 1 in front on the glass. If the glass is not held firmly when the threaded cap is fully screwed in, install an extra o-ring.

MOUNTING

Installation Instructions

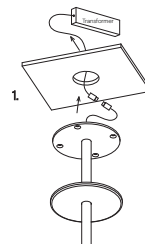

Prep the ceiling with an approx. 50mm hole to fit the transformer. Place the transformer in the ceiling and feed the cable through the hole into the room. Connect the single electrified cable to the transformer.

*The transformer needs to be accessible for maintenance purposes.

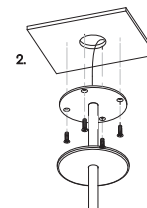

Screw the steel mounting plate to the ceiling using appropriate fasteners for the ceiling substrate.

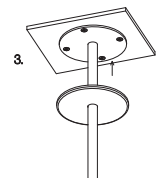

Secure the magnetic cover plate onto the mounting plate.



CORAL TRI ROD PENDANT LIGHT

Designed and Handmade by Oliver Höglund & Ryan Roberts

Embellish your walls with the Coral Tri Rod pendant light, available in both clear and frosted finishes. This statement piece adds a modern contemporary feature ideal for kitchens, bedrooms, bathrooms and entryways. Tailor it to your preferences by selecting a wall plate finish of natural brass, matte black, matte white, medium bronze or steel finish and set the mood of your space with a choice of warm, warm white, or white LED temperatures. Meticulously hand-blown using premium Swedish clear glass, each disc carries the distinctiveness of SOKTAS Glass designs, promising an unparalleled and personalised lighting masterpiece that adds both elegance and character to your space.

Hand Made in Currumbin, Australia.



TECHNICAL DATA

Application	Interior & Outdoor Use	Input Power	100-240V AC
Glass	Frosted / Clear	Output Power	7V DC Driver (350mA Constant Current) Supplied with Remote Driver
Rod Finish	Matte Black / Matte White / Natural Brass / Steel Finish / Medium Bronze Powdercoat	Dedicated LED	3 x 1W (Standard) / 3 x 2W (additional cost) Lifespan - 60,000+ Hours CRI>90
Glass Dimensions	3 x 120mm	Colour Temperature	2700K / 3000K (Standard) / 4000K
IP Rating	IP65	Dimming	TRIAC/Phase Dimmable (Standard) DALI (additional cost) Please contact for alternative dimming options
Warranty	24 Months / 2 Years		
Certification	AU/NZ AS/NZS 60598.1, 60598.2.1 EU EN 60598.1, 60598.2.1 US/CAN ETL/UL 1598, CSA C22.2#250.0		

DIMENSIONS

Glass Installation

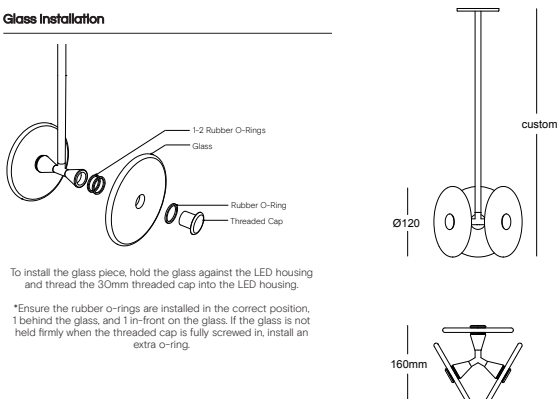

MOUNTING

Installation Instructions

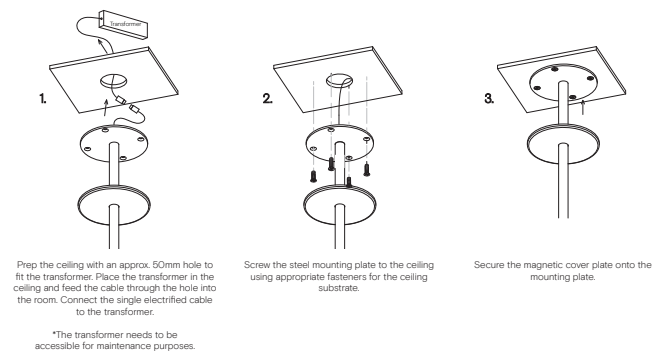



CORAL

LINEAR ROD PENDANT (x6)

Designed and Handmade by Oliver Höglund & Ryan Roberts

Elevate your space with the Coral Linear Rod pendant light, a captivating modern centrepiece perfect for dining spaces and over kitchen islands. Six exquisite glass-blown discs are suspended from a beautiful crafted rod structure, available in a selection of finishes including natural brass, steel finish, matte black, matte white, or medium bronze powder coating. Choose from a frosted or clear finish and set the mood of your space with a choice of warm, warm white, or white LED temperatures. Meticulously hand-blown using premium Swedish clear glass, each disc carries the distinctiveness of SOKTAS Glass designs, promising an unparalleled and personalised lighting masterpiece that adds both elegance and character to your space.

Hand Made in Currumbin, Australia.



TECHNICAL DATA

Application	Interior Use Only	Input Power	100 - 240VAC
Glass Colour	Clear / Frosted	Output Voltage (Standard)	17-19V DC Driver (350mA Constant Current) Supplied with Remote Driver
Rod Suspensions	Natural Brass / Matte Black / Matte White / Steel / Finish / Medium Bronze Powdercoat	Dedicated LED	6 x 1W - 350mA (Standard) 6 x 2W - 350mA (additional cost) Lifespan - 60,000+ Hours CRI>90
Ceiling Canopy	Natural Brass / Matte Black / Matte White / Steel Finish Medium Bronze Powdercoat	Colour Temperature	2700K / 3000K (Standard) / 4000K
Dimensions	Glass Diameter: 170mm Linear Rod: 1000mm	Dimming	Yes - Dimmable TRIAC/Phase (Standard) Dimmable DALI (additional cost) Please contact for alternative dimming
Measurement between vertical rods - 500mm		Warranty	24 Months / 2 Years
Certification	AU/NZ AS/NZS 60598.1, 60598.2.1 EU EN 60598.1, 60598.2.1 US/CAN ETL/UL 1598, CSA C22.2#250.0		

DIMENSIONS

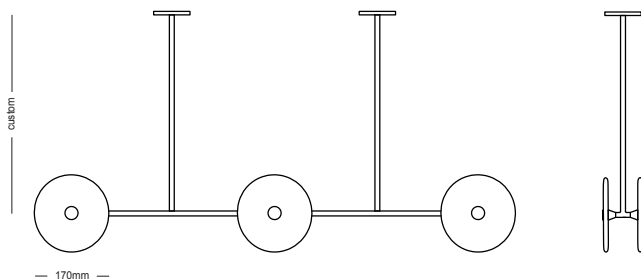

MOUNTING

Installation Instructions

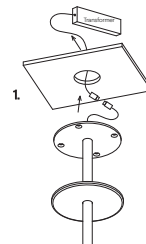

1. Prep the ceiling with an approx. 50mm hole to fit the transformer. Place the transformer in the ceiling and feed the cable through the hole into the room. Connect the single electrified cable to the transformer.

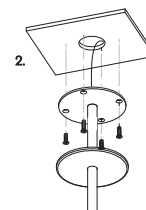

2. Screw the steel mounting plate to the ceiling using appropriate fasteners for the ceiling substrate.

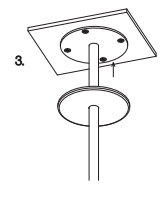

3. Secure the magnetic cover plate onto the mounting plate.

*The transformer needs to be accessible for maintenance purposes.



CORAL

LINEAR ROD PENDANT (x4)

Designed and Handmade by Oliver Höglund & Ryan Roberts

Elevate your space with the Coral Linear Rod pendant light, a captivating modern centrepiece perfect for dining spaces and over kitchen islands. Four exquisite glass-blown discs are suspended from a beautiful crafted rod structure, available in a selection of finishes including natural brass, steel finish, matte black, matte white, or medium bronze powder coating. Choose from a frosted or clear finish and set the mood of your space with a choice of warm, warm white, or white LED temperatures. Meticulously hand-blown using premium Swedish clear glass, each disc carries the distinctiveness of SOKTAS Glass designs, promising an unparalleled and personalised lighting masterpiece that adds both elegance and character to your space.

Hand Made in Currumbin, Australia.



TECHNICAL DATA

Application	Interior Use Only	Input Power	100 - 240VAC
Glass Colour	Clear / Frosted	Output Voltage (Standard)	12V DC Driver (350mA Constant Current) Supplied with Remote Driver
Rod Suspensions	Natural Brass / Matte Black / Matte White / Steel Finish / Medium Bronze Powdercoat	Dedicated LED	4 x 1W - 350mA (Standard) 4 x 2W - 350mA (additional cost) Lifespan - 60,000+ Hours CRI>90
Ceiling Canopy	Natural Brass / Matte Black / Matte White / Steel Finish / Medium Bronze Powdercoat	Colour Temperature	2700K / 3000K (Standard) / 4000K
Dimensions	Glass Diameter: 170mm Linear Rod: 1000mm	Dimming	Yes - Dimmable TRIAC/Phase (Standard) Dimmable DALI (additional cost) Please contact for alternative dimming
Measurement between vertical rods - 500mm		Warranty	24 Months / 2 Years
Certification	AU/NZ AS/NZS 60598.1, 60598.2.1 EU EN 60598.1, 60598.2.1 US/CAN ETL/UL 1598, CSA C22.2#250.0		

DIMENSIONS

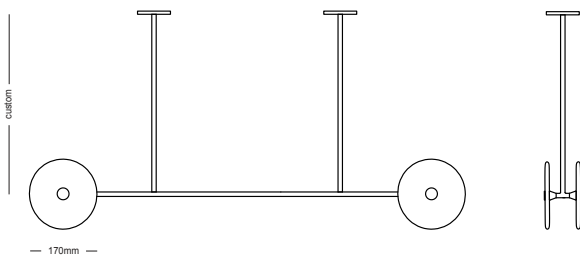

MOUNTING

Installation Instructions

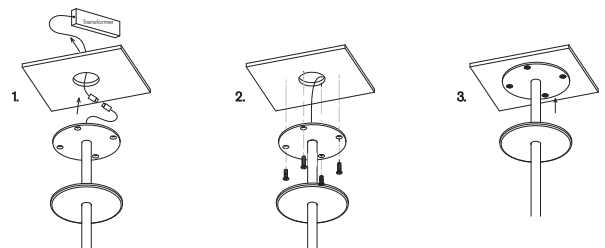

1. Prep the ceiling with an approx. 50mm hole to fit the transformer. Place the transformer in the ceiling and feed the cable through the hole into the room. Connect the single electrified cable to the transformer.

2. Screw the steel mounting plate to the ceiling using appropriate fasteners for the ceiling substrate.

3. Secure the magnetic cover plate onto the mounting plate.

*The transformer needs to be accessible for maintenance purposes.



CORAL

LINEAR QUAD PENDANT (x4)

Designed and Handmade by Oliver Höglund & Ryan Roberts

Elevate your space with the Coral Quad Linear pendant light, a captivating modern centrepiece perfect for dining spaces and over kitchen islands. Four exquisite glass-blown discs are suspended from a beautiful crafted rod structure, available in a selection of finishes including natural brass, steel finish, matte black, matte white, or medium bronze powder coating. Choose from a frosted or clear finish and set the mood of your space with a choice of warm, warm white, or white LED temperatures. Meticulously hand-blown using premium Swedish clear glass, each disc carries the distinctiveness of SOKTAS Glass designs, promising an unparalleled and personalised lighting masterpiece that adds both elegance and character to your space.

Hand Made in Currumbin, Australia.



TECHNICAL DATA

Application	Interior Use Only	Input Power	100 - 240VAC
Glass Colour	Clear / Frosted	Output Voltage (Standard)	12V DC Driver (350mA Constant Current) Supplied with Remote Driver
Rod Suspensions	Natural Brass / Matte Black / Matte White / Steel Finish / Medium Bronze Powdercoat	Dedicated LED	4 x 1W - 350mA (Standard) 4 x 2W - 350mA (additional cost) Lifespan - 60,000+ Hours CRI>90
Ceiling Canopy	Natural Brass / Matte Black / Matte White / Steel Finish / Medium Bronze Powdercoat	Colour Temperature	2700K / 3000K (Standard) / 4000K
Dimensions	Glass Diameter: 180mm Linear Rod: 800mm	Dimming	Yes - Dimmable TRIAC/Phase (Standard) Dimmable DALI (additional cost) Please contact for alternative dimming
Measurement between vertical rods	800mm	Warranty	24 Months / 2 Years
Certification	AU/NZ AS/NZS 60598.1, 60598.2.1 EU EN 60598.1, 60598.2.1 US/CAN ETL/UL 1598, CSA C22.2#250.0		

DIMENSIONS

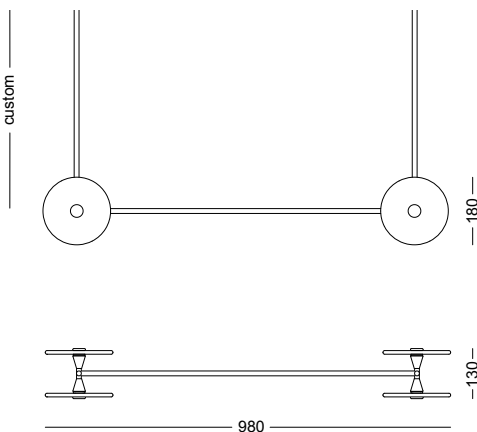

MOUNTING

Installation Instructions

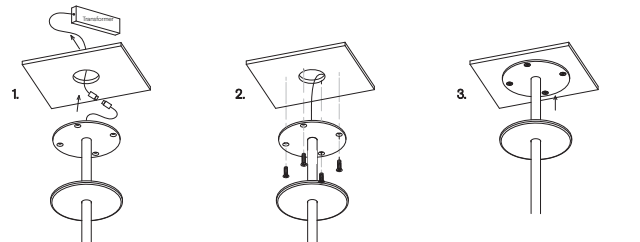

Prep the ceiling with an approx. 50mm hole to fit the transformer. Place the transformer in the ceiling and feed the cable through the hole into the room. Connect the single electrified cable to the transformer.

Screw the steel mounting plate to the ceiling using appropriate fasteners for the ceiling substrate.

Secure the magnetic cover plate onto the mounting plate.

*The transformer needs to be accessible for maintenance purposes.



CORAL DUO

WALL LIGHT

Designed and Handmade by Oliver Höglund & Ryan Roberts

Embellish your walls with the Coral Duo wall light and add a modern contemporary feature ideal for kitchens, bedrooms, bathrooms and entryways. This statement piece features two hand-blown glass discs available in both clear and frosted finishes. Tailor it to your preferences by selecting a wall plate finish of brass finish, matte black, matte white, medium bronze or steel finish and set the mood of your space with a choice of warm, warm white, or white LED temperatures. Meticulously hand-blown using premium Swedish clear glass, each disc carries the distinctiveness of SOKTAS Glass designs, promising an unparalleled and personalised lighting masterpiece that adds both elegance and character to your space.

Hand Made in Currumbin, Australia.

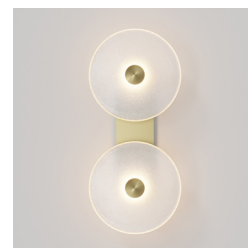

TECHNICAL DATA

Application	Interior Use (Optional: Outdoor Use) Low Voltage (under 12v)	Input Power	100-240V AC
Glass	Frosted / Clear	Output Power	4V DC Driver (350mA Constant Current) Supplied with Remote Driver
Cover Cap Finish	Matte Black / Matte White / Brass Finish / Steel Finish / Medium Bronze Powdercoat	Dedicated LED	2 x 1W - (Standard) / 2 x 2W (additional cost) Lifespan - 60,000+ Hours CRI>90
Wall Mount Finish	Matte Black / Matte White / Brass Finish / Steel Finish / Medium Bronze Powdercoat	Colour Temperature	2700K / 3000K (Standard) / 4000K
Glass Dimensions	170mm	Dimming	TRIAC/Phase Dimmable (Standard) DALI (additional cost) Please contact for alternative dimming options
IP Rating	IP20 Indoor	Mounting	Integral Wall Bracket
Warranty	24 Months / 2 Years	Certification	AU/NZ AS/NZS 60598.1, 60598.2.1 EU EN 60598.1, 60598.2.1 US/CAN ETL/UL 1598, CSA C22.2#250.0

DIMENSIONS

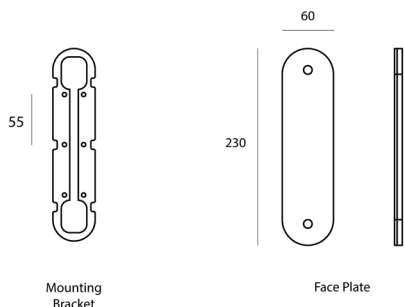

MOUNTING

Installation Instructions

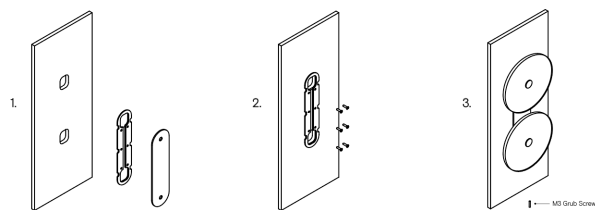

1. Prep the wall with 2 holes to match the wall plate cutouts. Secure the transformer into the wall cavity and feed the cable through the hole into the room. Connect the single electrified cable to the transformer.

2. Screw the mounting plate to the wall using appropriate fasteners for the wall substrate.

3. Fit the face plate (with attached lights) over the mounting plate and secure with the supplied M3 grub screw at the bottom of the plate.

*The transformer needs to be accessible for maintenance purposes.



CORAL TRIO WALL LIGHT

Designed and Handmade by Oliver Höglund & Ryan Roberts

Embellish your walls with the Coral Trio wall light and add a modern contemporary feature ideal for kitchens, bedrooms, bathrooms and entryways. This statement piece features three hand-blown glass discs available in both clear and frosted finishes. Tailor it to your preferences by selecting a wall plate finish of brass finish, matte black, matte white, medium bronze or steel finish and set the mood of your space with a choice of warm, warm white, or white LED temperatures. Meticulously hand-blown using premium Swedish clear glass, each disc carries the distinctiveness of SOKTAS Glass designs, promising an unparalleled and personalised lighting masterpiece that adds both elegance and character to your space.

Hand Made in Currumbin, Australia.

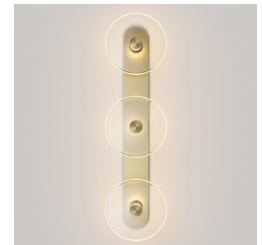

TECHNICAL DATA

Application	Interior Use (Optional: Outdoor Use) Low Voltage (under 12v)	Input Power	100-240V AC
Glass	Frosted / Clear	Output Power	4V DC Driver (350mA Constant Current) Supplied with Remote Driver
Cover Cap Finish	Matte Black / Matte White / Brass Finish / Steel Finish / Medium Bronze Powdercoat	Dedicated LED	3 x 1W - (Standard) / 3 x 2W (additional cost) Lifespan - 60,000+ Hours CRI>90
Wall Mount Finish	Matte Black / Matte White / Brass Finish / Steel Finish / Medium Bronze Powdercoat	Colour Temperature	2700K / 3000K (Standard) / 4000K
Glass Dimensions	170mm Wall Mount: 500 x 60mm Protrudes: 50mm	Dimming	TRIAC/Phase Dimmable (Standard) DALI (additional cost) Please contact for alternative dimming options
IP Rating	IP20 Indoor	Mounting	Integral Wall Bracket
Warranty	24 Months / 2 Years	Certification	AU/NZ AS/NZS 60598.1, 60598.2.1 EU EN 60598.1, 60598.2.1 US/CAN ETL/UL 1598, CSA C22.2#250.0

DIMENSIONS

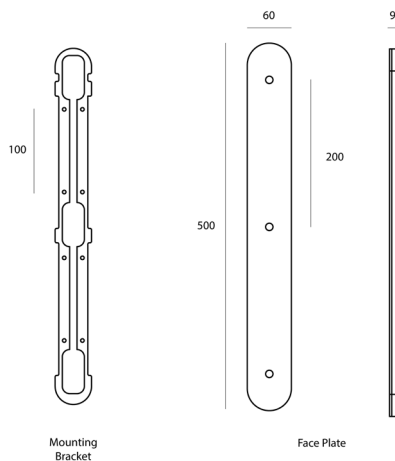

MOUNTING

Installation Instructions

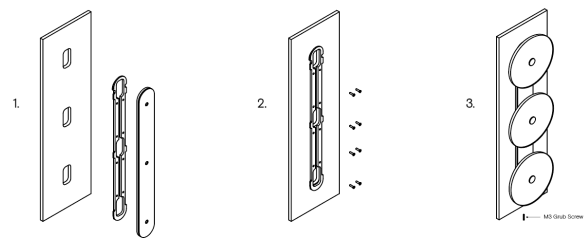

1. Prep the wall with 3 holes to match the wall plate cutouts. Secure the transformer into the wall cavity and feed the cable through the hole into the room. Connect the single electrified cable to the transformer.

*The transformer needs to be accessible for maintenance purposes.

2. Screw the mounting plate to the wall using appropriate fasteners for the wall substrate.

3. Fit the face plate (with attached lights) over the mounting plate and secure with the supplied M3 grub screw at the bottom of the plate.