

zuhnë

Start something great

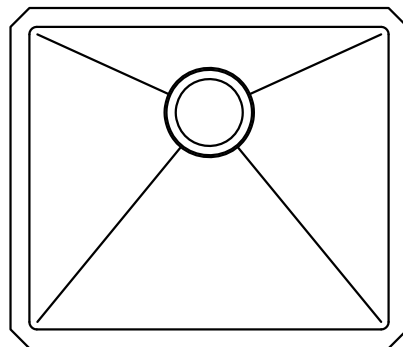

MODENA 21

21in x 18in x 9in



PRODUCT INFORMATION

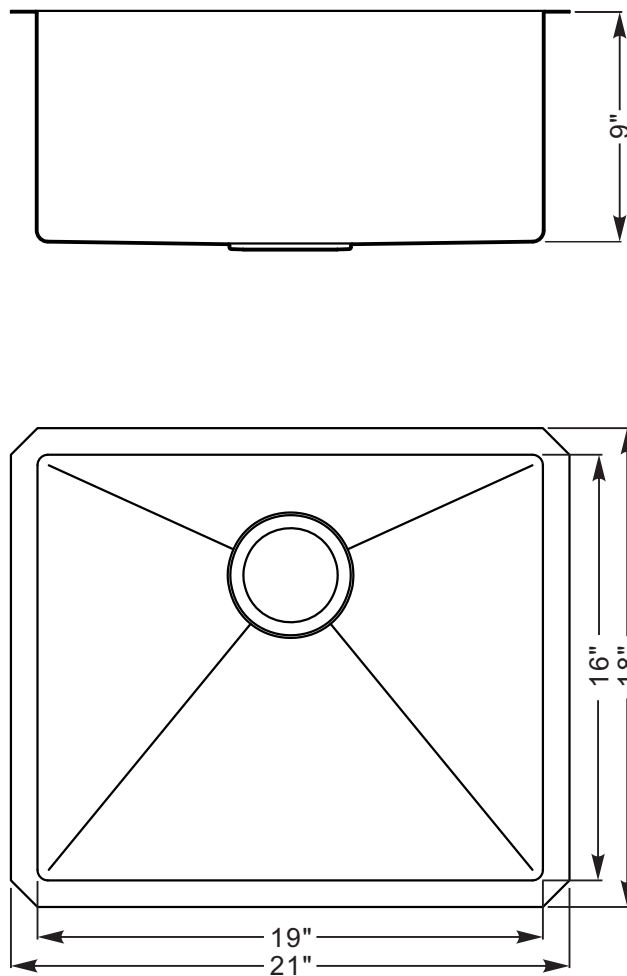

Fig.1

PRODUCT DESCRIPTION

- Premium grade handmade sink
- 16 gauge Stainless Steel T304
- 10mm/0.4inch radius coved corners
- Best-in-breed sound and thermal insulation
- Limited lifetime warranty

PACKING LIST

- Sink
- Strainer(s)*
- Bottom Grid(s)**
- Mounting Hardware
- Cut-out Template

*All sinks come with a basket strainer. Double bowl sinks include a second strainer.

**Single bowl sinks include a one-piece bottom grid. Double bowl sinks come with a two-piece bottom grid.

INSTALLATION INSTRUCTIONS

PRODUCT INFORMATION

CAUTION

Due to the weight and sharp edges of the sink, exercise caution when handling, moving or lifting the box or the sink. Use safety gloves and protective gear for eyes and ears. Get assistance when lifting or mounting the sink at any time during the installation procedure. **DO NOT** attempt to handle or install this product if doing so poses a risk of bodily injury or if you are medically unfit to carry out the installation.

IMPORTANT: Zuhne strongly recommends that this product be installed by a licensed plumber. Ensure that installation complies with applicable plumbing and building codes.

CHECK LIST: Have the following tools and materials available prior to commencing installation:

- Silicone adhesive sealant
- Tape measure and pencil
- Hacksaw/Jigsaw
- Denatured alcohol
- Rags

Ensure the following prior to installing the product:

- None of items in packing list are missing
- Counter top is clean, dry, flat and unobstructed
- Water supply is turned off

INSTALLATION

Figures 2 & 3 illustrate how the sink is under-mounted onto the countertop. Follow these steps:

1. Place the cutout template at the desired position on the countertop, ensuring that the bowl(s) are centralized and aligned with cabinet and faucet holes.
2. Use cutout template to size countertop opening and cut the countertop accordingly. Note that the cutout template is to be used for reference only. Confirm that the countertop opening is correctly dimensioned on all sides by measuring against the sink directly. The countertop opening must be aligned on all sides with the sink flange.
3. Drill holes will be required on the underside of the countertop to screw the mounting brackets. These holes should be approximately 1 inch away from the edges of the sink flange and must be spaced evenly all around the sink flange at approximately 6-8 inches apart.
4. Screw mounting brackets onto the countertop loosely, pointing them parallel to the countertop opening (bent end of the mounting brackets must not be screwed).
5. At this time, ensure that the underside of the countertop (area that the sink flange will adhere to) is clean and smooth. Ensure that the sink flange is also clean.
6. Apply silicone adhesive sealant on the sink flange evenly. Place and align sink flange to the countertop cutout and push sink firmly onto the countertop.
7. Keeping the sink pressed up against the countertop, turn bent end of the mounting brackets so that they snug under the sink flange.
8. Check sink-countertop alignment from all sides again and fasten mounting brackets.
9. Ensure that the countertop surface and sink are clean. Wipe away excess silicone adhesive immediately.

IMPORTANT: Apply silicone sealant adhesive on the sink flange only after ensuring that the countertop opening is in complete alignment with the sink **AND** that the mounting brackets are placed correctly.

INSTALLATION INSTRUCTIONS

CARE AND MAINTENANCE

SUPPORT AND WARRANTY

INSTALLATION INSTRUCTIONS

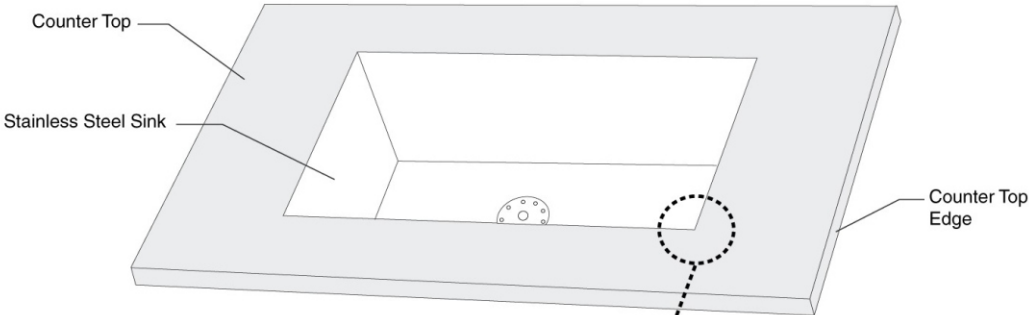

Fig.2

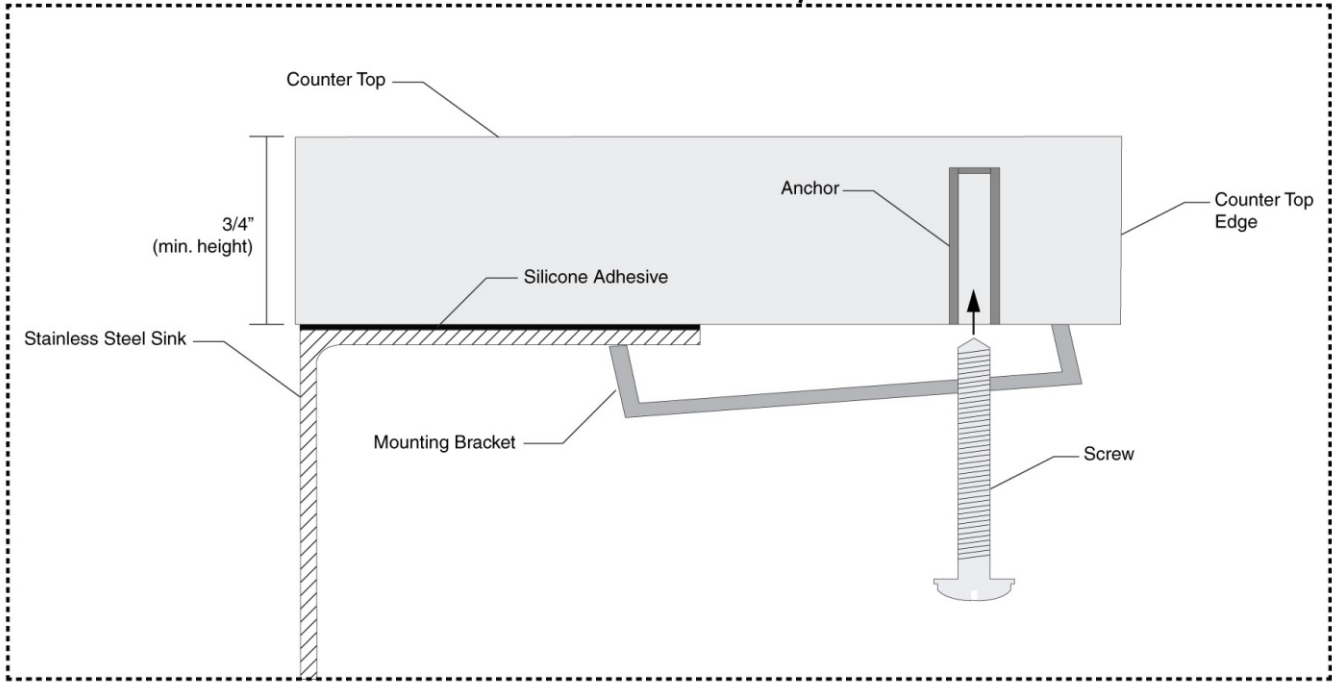

Fig.3

PRODUCT INFORMATION

INSTALLATION INSTRUCTIONS

CARE AND MAINTENANCE

SUPPORT AND WARRANTY

CARE AND MAINTENANCE

PRODUCT INFORMATION

You have purchased a premium product that is guaranteed to last a lifetime if proper care is taken.

DO NOT

- Leave standing water in the sink. Keep the sink clog-free at all times.
- Use abrasive cleaning materials such as steel wool that may scratch the surface.
- Use industrial grade or acid-based cleaning solutions that can damage the sink's surface or finish.
- Leave corrosive or rust-prone materials such as metal utensils or cookware for long periods of time in the sink.
- Leave any cleaning materials or household cleaning agents or bleach for long periods of time in the sink.
- Leave water spots on the sink. Clean and towel-dry the sink after every use.
- Use a sharp object such as a knife directly or indirectly on the sink.
- Rub or scrub against the direction of the grain lines on the sink.

CLEANING

- Clean the sink daily using mild soap and warm water. Wipe the sink dry after every use. Rub lightly in the direction of the grain lines.
- Use a mixture of vinegar and water if you find mineral deposits on the sink. Rinse the sink thoroughly if vinegar or other cleaning solutions are used.
- Stubborn stains may be removed using mild abrasive cleaners such as Bar Keepers Friend.

INSTALLATION INSTRUCTIONS

CARE AND MAINTENANCE

SUPPORT AND WARRANTY

SUPPORT AND WARRANTY

Customer Support

ZUHNE, LLC
8383 Commerce Park Drive #600
Houston, TX 77036

1-855-55-ZUHNE
www.zuhne.com
info@zuhne.com

ZUHNE, LLC Limited Lifetime Warranty Sinks

Pursuant to the terms and conditions set forth in this Limited Lifetime Warranty (this "Warranty"), ZUHNE, LLC ("ZUHNE") hereby warrants to the original consumer purchaser ("the Owner"), in the originally installed location, the enclosed sink (the "Product") to be free from any material defects in materials and workmanship. There are no express warranties other than those contained in this Warranty, and all representations or affirmations made by ZUHNE or any other person were for illustrative purposes only. No agent, employee, or representative of ZUHNE has any authority to bind ZUHNE to any affirmation, representation, or warranty concerning the Product, and unless an affirmation, representation, or warranty made by an agent, employee, or representative is specifically included within this Warranty, it will not be enforceable by the Owner.

Exclusions

Please refer to the Use & Care Manual supplied with your new ZUHNE product. This Warranty becomes null and void if any of the following are determined to be contributing factors to failure of the Product under this Warranty.

1. Abuse, neglect, misuse or misapplication.
2. Improper, dangerous, or destructive maintenance procedures.
3. Damages caused by services performed by unauthorized servicers.
4. Use in conjunction with any unapproved device.
5. Installation in an environment that is corrosive or otherwise destructive to the product, whether internal or external.
6. Installation in violation of applicable state or local plumbing or housing codes.
7. Acts of God including, but not limited to: fire, flood or natural disaster.

In the event of a ZUHNE recognized defect, malfunction, or failure to conform with this Warranty and based upon ZUHNE's approval of warranty claim, ZUHNE, at its sole and absolute discretion, will settle the warranty claim of such defect, malfunction, or failure to conform with this Warranty. In order to make a claim under this Warranty, the Owner must notify ZUHNE or its authorized representative of the failure of the Product to conform to this Warranty.

Under this Warranty, ZUHNE will only provide replacement parts. The Owner will be responsible for any other costs incurred including labor costs for servicing the product, shipping, delivery, and handling of the replacement part, costs for permits or materials necessary for the repair, or incidental costs resulting from damage external to the unit resulting from the failure.

NOTWITHSTANDING ANYTHING IN THIS WARRANTY TO THE CONTRARY, EXCEPT FOR ZUHNE'S AFFIRMATIVE OBLIGATIONS EXPRESSLY SET FORTH IN THIS WARRANTY, ZUHNE DISCLAIMS ANY AND ALL WARRANTIES, EITHER EXPRESS OR IMPLIED, REGARDING THE PRODUCT AND ITS FUNCTIONALITY, PERFORMANCE, MERCHANTABILITY, FITNESS FOR PARTICULAR PURPOSE OR INTELLECTUAL PROPERTY RIGHTS. ZUHNE DISCLAIMS ALL OTHER OBLIGATIONS OR LIABILITIES ON ITS PART AND NEITHER ASSUMES NOR AUTHORIZES ANY OTHER PERSON TO ASSUME FOR ZUHNE ANY OTHER LIABILITIES IN CONNECTION WITH THE PERFORMANCE OF THE PRODUCT. THIS WARRANTY ONLY COVERS REPLACEMENT PARTS AND DOES NOT COVER COST OF LABOR OR SERVICES UNDER ANY CIRCUMSTANCES.

This Warranty only applies to the 50 States of the U.S.A. ZUHNE shall not be liable for any claim or demand against ZUHNE by any other part for damages of any kind, including, but not limited to incidental and consequential damages, arising out of the subject matter of this Agreement. Some States do not allow exclusion or limitation of incidental or consequential damages, so the above limitation or exclusion may not apply to you. This Warranty gives you specific legal rights. You may also have other rights that vary from State to State.

PRODUCT INFORMATION

INSTALLATION
INSTRUCTIONS

CARE AND MAINTENANCE

SUPPORT AND WARRANTY