



# **BARNETT™**

— EST. 1962 —>

**BAR20020**  
**CRANK COCKING DEVICE (C.C.D.)**  
Installation and Operating Manual

**For use with Barnett Crossbow models  
(see inside for a full list of compatible models)**

---

For further information please call Customer Service on 1-800-237-4507  
Visit us online @ [www.barnettcrossbows.com](http://www.barnettcrossbows.com)

# Crank Cocking Device (C.C.D.) Components:

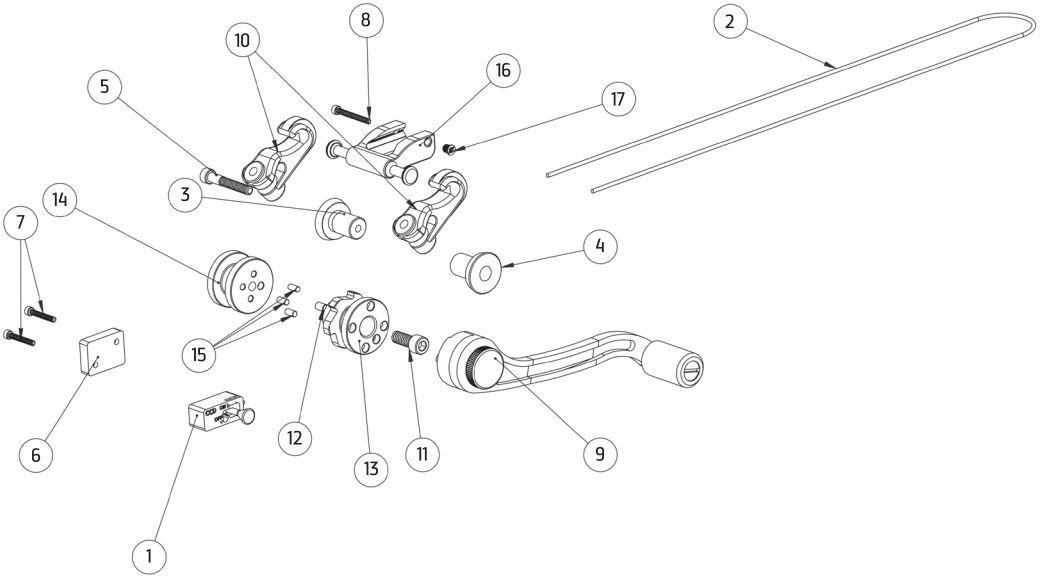

1	BAR230660	CCD Catch Assembly
2	BAR730056	CCD String
3	BAR730034	CCD Anchor Side Two
4	BAR730033	CCD Anchor Side One
5	3138	10-24 x 1.25 Socket Screw
6	5203	Backing Plate
7	3178	4-40 x 3/4 Socket Screw
8	3181	4-40 x 1.0 Socket Screw
9	5216	CCD Handle
10	BAR730047	RCD Hooks
11	3044	1/4-20 x 5/8 Socket Screw
12	3176	Dowel Pin - Large
13	5212	CCD Spool - Right
14	5211	CCD Spool - Left
15	3153	Dowel Pin - Small
16	BAR730090	String Hook Holder
17	BAR730118	4-40 Brass Insert

# Crank Cocking Device (C.C.D.) Compatible Models and Screw Sizes:

3178 - #4-40 x 3/4" Screws	3181 - #4-40 x 1" Screws	
Raptor FX3 MO Brush	Raptor Reverse	Brotherhood
Raptor Pro STR	HeadHunter Reverse	Droptine / Droptine XT / Droptine STR
Whitetail Hunter Pro	Vicious	BC Droptine XT
Whitetail Hunter Pro FX	DOA < 2016	Droptine STR Strata
Whitetail Pro STR	Quad 400	Droptine STR Terra
Razr / Razr Ice	Recruit Compound	Droptine STR Eclipse
	Recruit Terrain / Recruit Tactical	Wildcat C6 Black / Wildcat C6 Camo
	Recruit Youth 30 / 60 / 100 / 100 PINK	Wildcat Q6
	Recruit Terrain XT / Recruit Terrain CXB	Wildcat C7
	Brotherhood M4	Kryptonite
	Raptor FX / Raptor FX2 / Raptor FX3	G350C
	Assault	Ghost 360
	Avenger	Ghost 375
	Veloci Raptor	Vindicator
	Black Raptor FX / Black Raptor FX2	
	Blackspur / Blackspur TT	
	Lady Raptor	
	Whitetail Hunter / Whitetail Hunter II	
	Whitetail Hunter II DSG	
	Whitetail Hunter II Kanati	
	Whitetail Hunter STR	
	Lady Whitetail Hunter	
	Ghost 410 Carbon / Ghost 410 Camo	
	Ghost 415 Mono / Ghost 415 Mossy	
	Ghost 420	
	Finality 360 / Finality 390	
	Ghost 385	
	BCX	
	Buck Commander	

# Installation Instructions

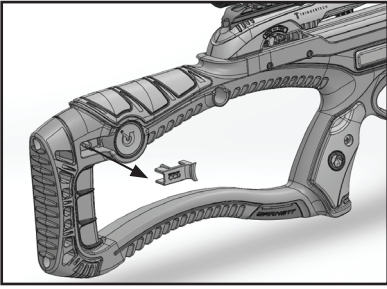

## Step 1:

Using a small screwdriver or something similar, pry off the CCD catch cover by placing the screwdriver into the small slot located in the CCD catch cover, located towards the butt pad. Once removed, the opposite side cover can now easily be removed by pushing the small tab located behind the already removed CCD catch cover, away from the stock.

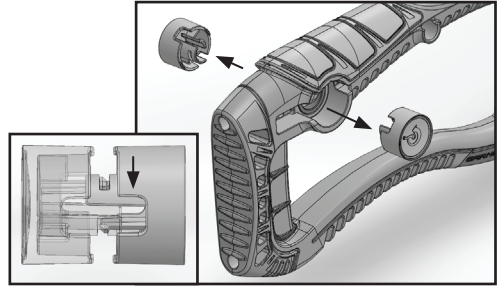

## Step 2:

Using the same small screwdriver or tool, remove one of the remaining CCD spool covers by gently sliding the tool into the gap in the cover and pressing the inner tab of the cover towards the center of the spool while slightly pulling the CCD spool cover out and away from the stock.

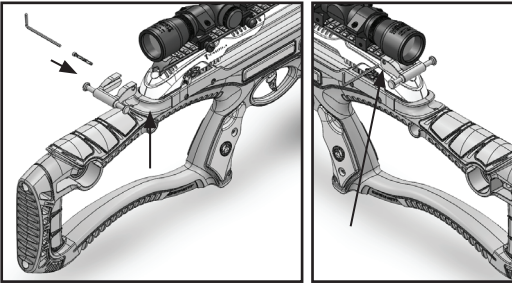

## Step 3:

Locate the string hook holder and the #4-40 x 1.0" socket head cap screw. Align the string hook holder with the scope rail and slide on until snug. Push the #4-40 x 1.0" socket head cap screw through the left side of the string hook holder, as shown to the left, tighten until snug using the provided 3/32 allen key.

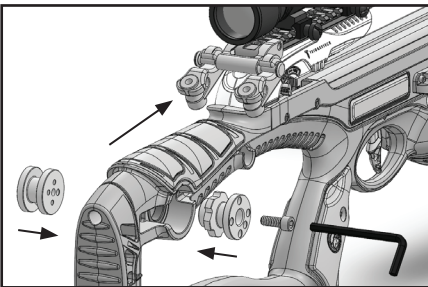

## Step 4:

Locate the CCD spools assembled with the string hooks attached. Place the string hooks onto the string hook holder, as shown above before removing the #1/4 -20 x 5/8" socket head cap screw from the pre-assembled left and right CCD spools with the provided 3/16 allen key. After disassembling the two, place the right spool (with gear) into the right side of the stock, and the left spool (no gear) into the left side of the stock. Be sure to align the dowel pins on each spool before tightening the #1/4 -20 x 5/8" socket head cap screw with the 3/16 allen key. *Note: You can attach the CCD handle to the left spool to keep the spools from spinning when tightening the #1/4 -20 x 5/8" socket head cap screw.*

## Installation Instructions (continued)

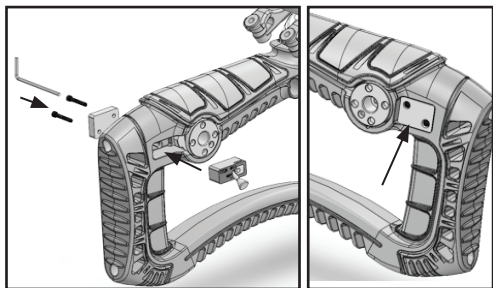

### Step 5:

With the CCD catch lever in the "OFF" position, place the CCD catch assembly and backing plate in the stock. After locating the correct length #4-40 screws for your model crossbow (see table on page 3), insert the two screws into the backing plate as shown above. Using the 3/32 allen key, tighten the #4-40 screws until snug. *Note: There are two sets of #4-40 screws, one set is  $\frac{3}{4}$ " long and the other is 1.0" long. Please see page 3 for the correct screw length for your model crossbow.*

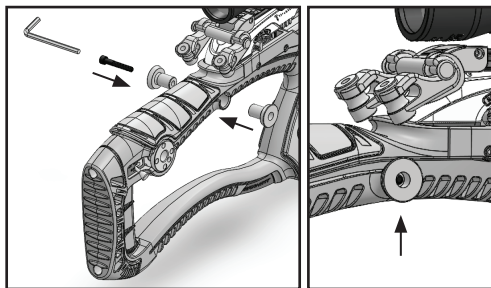

### Step 6:

Place the slack CCD string coming from the spools to the string hooks into the string grooves on either side of the stock. Locate the two CCD anchors and the #10-24 x 1.25" socket screw from the assembly package. Place one CCD anchor in each side of the stock as shown above before tightening down the #10-24 x 1.25" socket screw with the supplied 5/32 allen key. *Note: You will notice one of the CCD anchors is threaded while the other is not. Push the #10-24 x 1.25" socket screw through the non-threaded CCD anchor and tighten into the opposite CCD anchor until snug.*

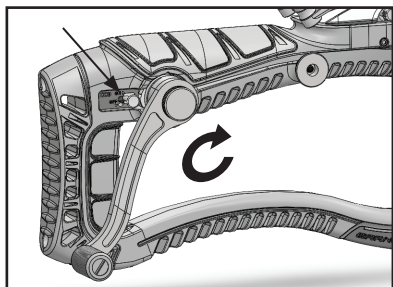

### Step 7:

To keep the string hooks locked in place when attached to the string hook holder, attach the CCD handle to either spool of the CCD assembly and place the CCD catch in the "ON" position. Rotate the CCD handle clockwise until the CCD string is taut and the hooks are pulled tight into position. *Note: Overtightening the CCD string will cause damage to components of the assembly.*

# Operating Instructions

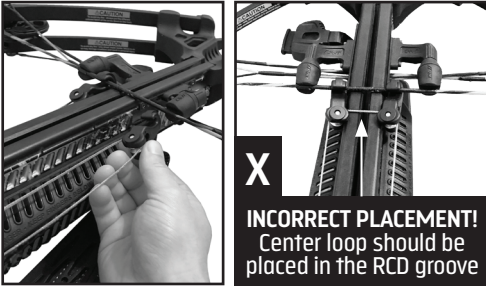

## Step 1:

With the CCD handle removed from the CCD assembly and the CCD catch lever in the "OFF" position, remove the string hooks from the string hook holder and attach them to the crossbow string on their respective sides of the track. Ensure the center loop in the CCD string between the two string hooks is positioned in the RCD groove.

### **⚠ WARNING**

Not placing the CCD string into the RCD groove of the stock correctly puts you at immediate risk of serious personal injury and may result in catastrophic damage to your crossbow.

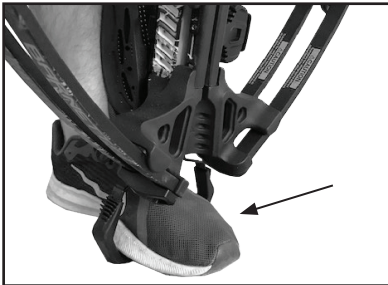

## Step 3:

Place one foot into the foot stirrup to keep the crossbow stable during the cocking of the bow. Be sure to place your foot far enough into the stirrup so that it will not slip out. Ensure a firm grip on the CCD handle as you crank the crossbow to the cocked position.

### **⚠ WARNING**

**ALWAYS** wear closed toe shoes when operating your crossbow.



## Step 2:

Attach the CCD handle to the spool and flip the CCD catch lever to the "ON" position.

### **⚠ WARNING**

**ALWAYS** wear safety glasses when assembling, cleaning, cocking, loading or shooting this Barnett crossbow.

### **⚠ WARNING**

**NEVER** attempt to cock a crossbow while in an elevated tree stand. Failure to follow these instructions may result in serious injury or death!

### **⚠ WARNING**

Place foot securely in foot stirrup, not doing so may cause the bow to move (or slip) while cocking and could cause damage to the bow or bodily injury.

### **⚠ WARNING**

Make sure that the CCD catch lever (CCD safety) is in the 'ON' position. If the safety is not engaged the handle will be allowed to auto rotate backwards if released and will cause damage to your crossbow and will cause bodily injury.

### **⚠ WARNING**

**NEVER** place fingers or thumbs on, in and/or near the arrow, the arrow/flight track, the string or the cables. Placing fingers and/or thumbs on, in or near these areas will result in serious injury, including finger and/or thumb amputation.

## Operating Instructions (continued)



**Step 4:**  
Rotate CCD handle until crossbow string is fully engaged into trigger mechanism. The safety of the crossbow will automatically engage. The tumbler latch of the trigger will now be holding the string.

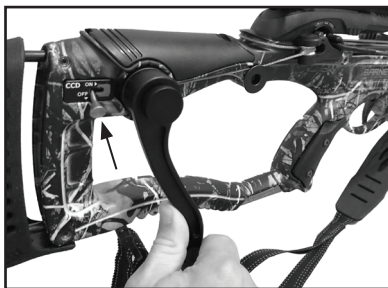

**Step 5:**  
Once fully cocked, turn the CCD handle to relieve the load on the CCD latch, then move the CCD catch lever to the "OFF" position with your other hand..



**Step 6:**  
Detach the string hooks from the bow string and attach them to the string hook holder.



**Step 7:**  
Re-engage the CCD latch by moving the lever from the "OFF" to the "ON" position once again.

### **⚠ WARNING**

**NEVER** fire your crossbow while the CCD hooks are engaged or in the path of the string or cables. This will break the CCD and or the crossbow and cause serious bodily injury.

### **⚠ WARNING**

**NEVER** attempt to de-cock your crossbow using the CCD. The only way to de-cock your crossbow is to shoot it into a safe target. Never attempt to de-cock your crossbow by hand, with a rope cocking device or using a crank cocking device. Attempting to do so puts you at risk of personal injury and voids the crossbow warranty.

### **⚠ WARNING**

Before disengaging the CCD catch lever, ensure you have a **FIRM** grip on the CCD handle and the bow is fully cocked to prevent injury and/or damage.

## Operating Instructions (continued)



### **Step 8:**

Crank the CCD until the strings are taut and then remove the CCD handle. **CAUTION: DO NOT OVER TIGHTEN.** Over-tightening when cranking will cause damage to the CCD assembly.



### **Step 9:**

Your crossbow is now ready to be loaded and fired.

**IMPORTANT!**  
**ALWAYS FOLLOW ALL OTHER WARNINGS AND  
SAFETY INSTRUCTIONS IN YOUR BARNETT  
CROSSBOW MANUAL.**