

WOODBENDER



ABOUT WOODBENDER

Inspired by a love of woodwork and a passion to explore the art of steam bending, Woodbender was started in 1988 by Charles Mast, later joined by his wife Shirley and father John. From the outset, the company specialised in bending solid wooden timber, reviving a closely guarded and secretive old-world tradition from 1700 Europe. Through hands-on trial and error, the team taught themselves how to bend kiln-dried timber and constructed much of the custom machinery required. Over the past three decades, Woodbender has experimented with numerous timbers and designs, leading to the current Collection of bentwood chairs and stools. Everything is made to order locally, in the Cape Winelands of South Africa, using sustainably sourced Ash timber from certified forests.

The unwavering commitment to product and people has enabled Woodbender to grow into a sizable enterprise, now overseen by the second generation, Andy Mast & Emily Bovell, who are dedicated to continuing the Mast family's legacy. Today, Woodbender takes pride in being the supplier of choice for restaurants, hotels, offices, and homes across South Africa, with a growing footprint in the UK and globally.



THE WOODBENDER COLLECTION

The name Woodbender has become synonymous with high-quality furniture known for its durability, comfort, and excellent value. The chairs and stools are individually handcrafted in South Africa using solid bentwood components, ensuring strength and durability for high-traffic environments in the hospitality industry.

The furniture is finished in the customer's choice of timber finish and upholstery fabric or leather and is designed for indoor use only. Each order leaving the factory is uniquely made to perfectly match its setting. Woodbender offers custom designs for large projects and is export-ready.



FABRICS & TIMBER FINISHES



Vuti Chair



Vuti Stool



Abbey Chair



Lina Chair



Kariba Chair



Kariba Stool



Makuti Chair



Makuti Stool



Flynn Chair



Riga Chair



Alta Chair



Henley Chair



Malmo Chair



Malmo Stool



Cala Chair



Cala Stool



Floro Chair



Oden Tub Chair



Arabella Tub Chair



Salsa Ottoman

- Customers can customise their furniture by specifying their own fabric or leather, along with the desired timber finish. All fabric and leather must be suitable for upholstery and can be sent directly to the factory or specified for Woodbender to order on the customer's behalf.
- Four standard timber finishes are available to choose from, including Light Brown, Dark Brown, Black and White. For large volume orders, custom timber finish options are also possible. (Please note that our Natural Finish is represented in this catalogue but due to limited availability of consistent colour planks we have had to discontinue this option).
- The water-based finish used is ready to use and environmentally friendly, offering an intense to slightly muted stain effect without overemphasising the grain of the timber. It is an emission-tested building product according to DIBt-rules.
- The PU multi-coat lacquer used, is a two-component PU lacquer on an acrylic resin base, known for resilience, lightfastness, and additional light protection. This multi-coat lacquer meets the EC type-examination certificate.



Light Brown



Dark Brown



Black



White



Custom Finish

Due to the variance in display setting on screens, all images are for illustrative purposes only. The wood stain colours may vary and may not be 100% representative of final finish. Please let us know if you require physical stain samples.



VUTI CHAIR

The Vuti is a sleek stacking chair (up to three chairs high), with a striking curved backrest and subtly sloped arms. This helps it to tuck in neatly under a tabletop making it ideal for compact spaces. The Vuti is also available as a kitchen and bar stool.

Width & depth: 500 x 530 mm

Seat height: 470 mm

Arm height: 730 mm

Backrest height: 760 mm

Fabric: 0.6 m

Weight: 5.9 kg

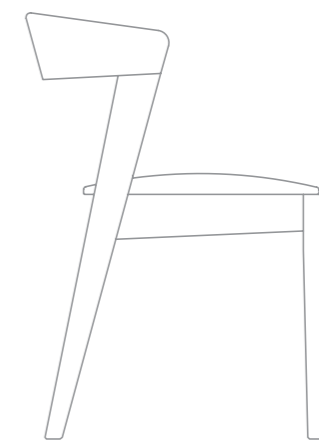

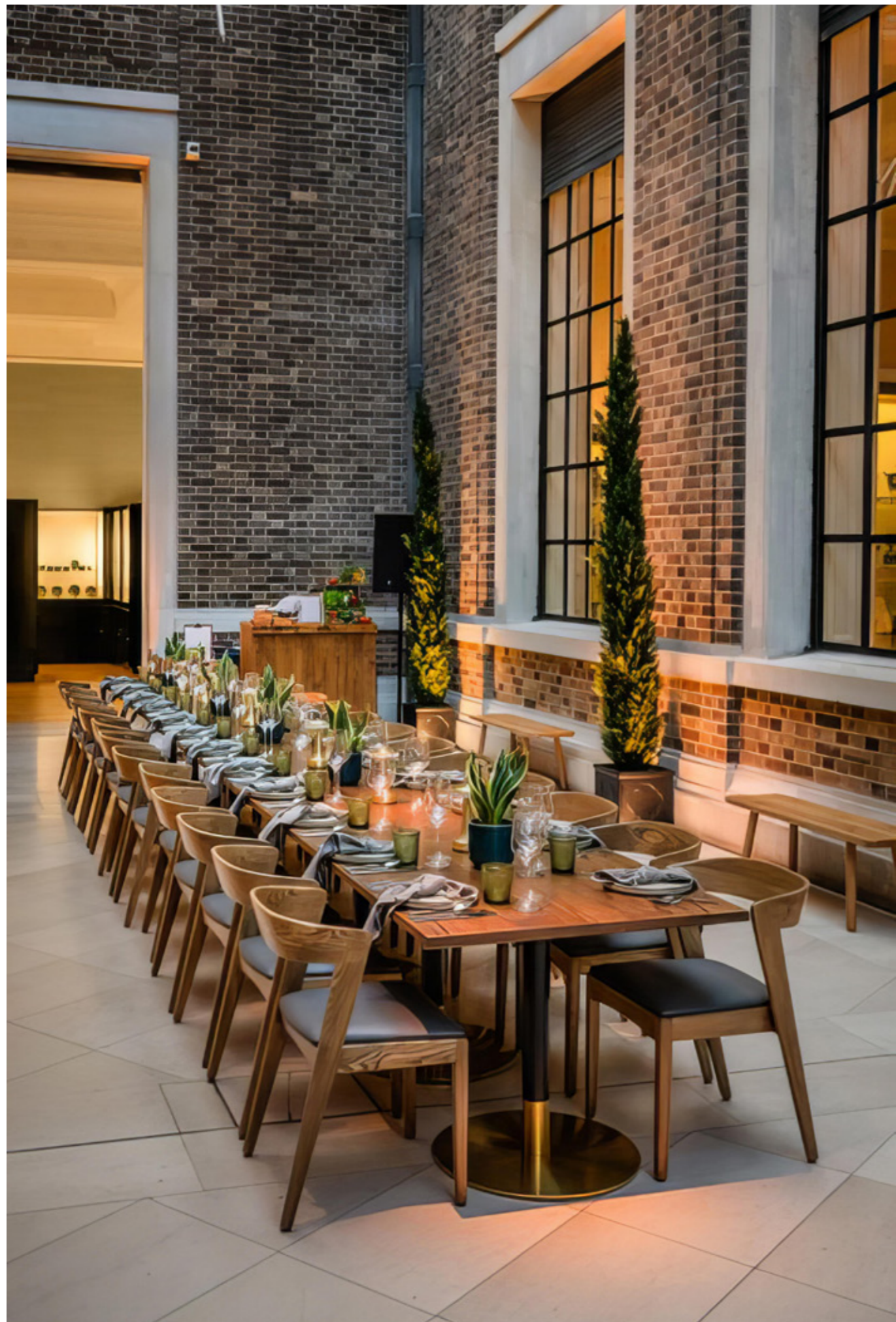



VUTI STOOL

The Vuti Stool, features an elegantly curved and open backrest. Its functional and space-saving design, with a subtly sloped backrest and no arms, allows it to tuck closely under a countertop, reducing its overall footprint. Available as a kitchen or bar stool and with a matching dining chair.

Width & depth: 490 x 540 mm

Seat height: 790 mm

Arm height: 990 mm

Backrest height: 1020 mm

Fabric: 0.6 m

Weight: 7.8 kg

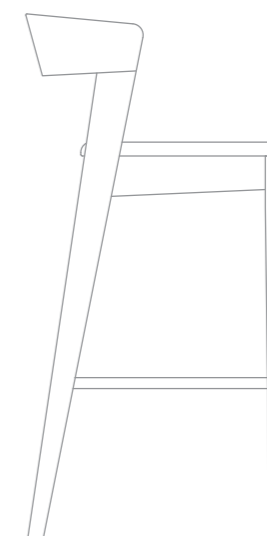





ABBEY CHAIR

The Abbey is a contemporary, wooden, stacking chair (up to four chairs high), with rounded dowel legs, a moulded seat, and a classic backrest design. It is also available with a solid wooden seat and works well in multipurpose venue spaces.

Width & depth: 505 x 475 mm

Seat height: 480 mm

Backrest height: 815 mm

Fabric: 0.6 m

Weight: 5 kg

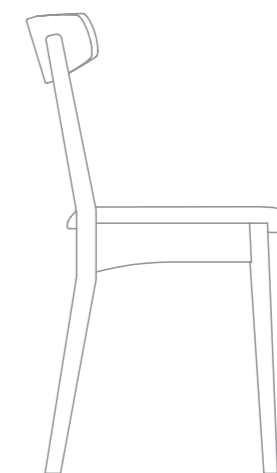





LINA CHAIR

The Lina Chair embodies simplicity and minimalist design through its graceful curves. The clean lines and curved backrest make it beautiful to look at whilst also providing exceptional strength and comfort. The Lina will be an elegant addition to any interior space, withstanding the test of time.

Width & depth: 550 x 555 mm

Seat height: 460 mm

Arm height: 640 mm

Backrest height: 750 mm

Fabric: 0.6 m

Weight: 5.3 kg

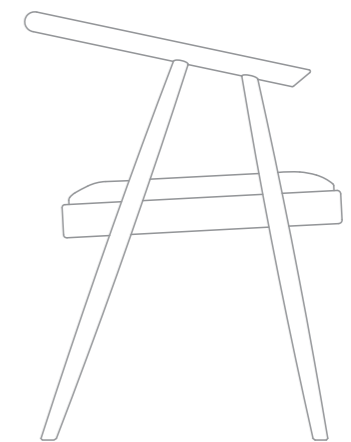



KARIBA CHAIR

The Kariba Chair is made from solid Ash wood with a sculptural bentwood backrest, and a large, comfortable seat. Engineered for durability with fewer parts, it's a modern and unique design for high-traffic spaces. The Kariba is also available as a kitchen and bar stool.

Width & depth: 550 x 510 mm

Seat height: 475 mm

Arm height: 710 mm

Backrest height: 750 mm

Fabric: 0.6 m

Weight: 7.2 kg

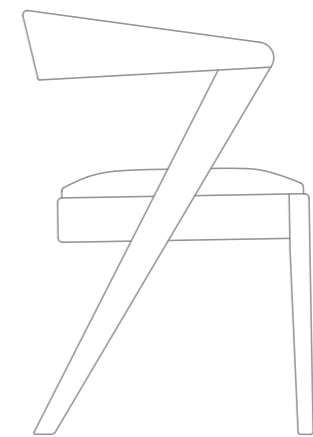





KARIBA STOOL

The Kariba Stools are handcrafted from solid Ash wood using steam bending. These stools are sculptural statement pieces with a large, comfortable seat. They are available in kitchen and bar stool heights and have a matching chair version.

Width & depth: 550 x 550 mm

Seat height: 790 mm

Arm height: 1010 mm

Backrest height: 1070 mm

Fabric: 0.6 m

Weight: 9.4 kg

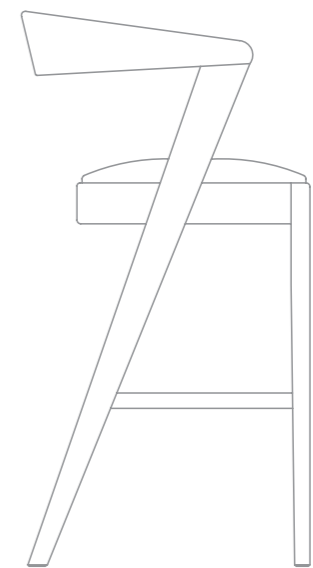





MAKUTI CHAIR

The Makuti is a compact dining chair but with a large, comfortable seat. With its armless design, it neatly tucks under tables, maximising floor space. Crafted from solid Ash wood, it boasts a sloped backrest for enhanced comfort and support and has a matching kitchen and bar stool.

Width & depth: 525 x 500 mm

Seat height: 470 mm

Backrest height: 730 mm

Fabric: 0.6 m

Weight: 6.3 kg

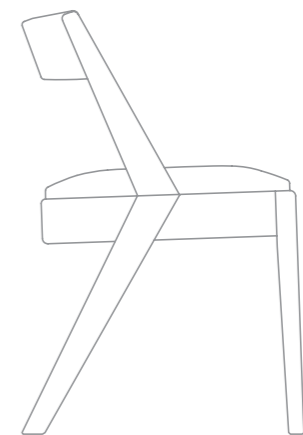





MAKUTI STOOL

The Makuti Stool offers easy accessibility, featuring a sloped, shallow backrest and an armless design. Its compact frame, large comfortable seat and solid wood structure make it a popular and durable choice of kitchen or bar stool. It also has a matching chair available.

Width & depth: 455 x 470 mm

Seat height: 785 mm

Backrest height: 960 mm

Fabric: 0.6 m

Weight: 7.6 kg







FLYNN CHAIR

The Flynn Chair blends minimalist design with innovation. Its unique features include a pivoting backrest, available upholstered or not and bentwood parts that enhance the durability of the frame whilst contributing to the graceful appearance.

Width & depth: 550 x 600 mm

Seat height: 460 mm

Arm height: 640 mm

Backrest height: 780 mm

Fabric: 0.6 m

Weight: 5.5 kg

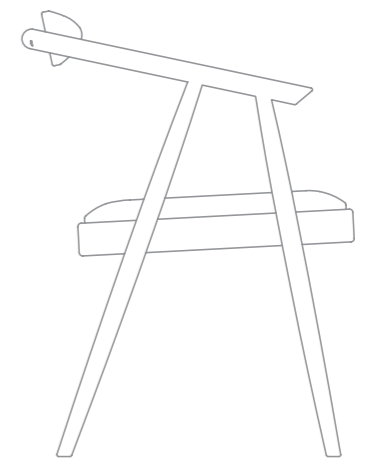





RIGA CHAIR

Breaking away from traditional chair frames, the Riga features an elegant back leg bending from the front of the arm, down to the floor, creating a unique silhouette. It is compact, lightweight and tucks halfway under a table, reducing its footprint.

Width & depth: 500 x 510 mm

Seat height: 490 mm

Arm height: 730 mm

Backrest height: 730 mm

Fabric: 0.6 m

Weight: 6 kg

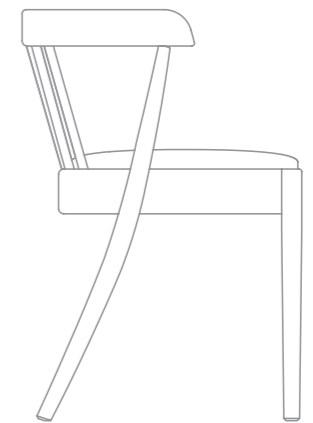





ALTA CHAIR

The Alta, an internationally award-winning design, recognised with two German design awards, is compact and lightweight. The bentwood backrest provides arm support while still easily tucking halfway under a table.

Width & depth: 500 x 510 mm

Seat height: 490 mm

Arm height: 730 mm

Backrest height: 730 mm

Fabric: 0.6 m

Weight: 6 kg

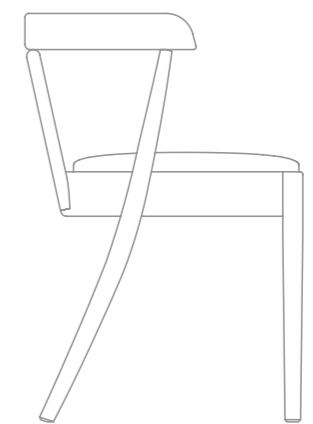





HENLEY CHAIR

The Henley was inspired by the iconic Windsor chair. It is crafted from solid Ash wood that is steamed and bent. It is lightweight with a small footprint and includes a bottom ring and bracing for superior strength for high traffic environments.

Width & depth: 460 x 500 mm

Seat height: 475 mm

Backrest height: 900 mm

Fabric: 0.6 m

Weight: 4.9 kg

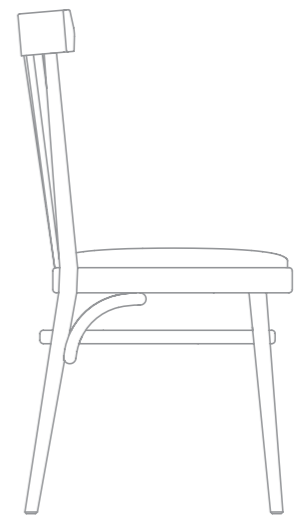





MALMO CHAIR

The Malmo, made from solid Ash wood, features an upholstered backrest with wooden edging. This protects the fabric and creates two fabric panels to mix and match fabrics. The Malmo is also available as a kitchen and bar stool to create a cohesive look in any space.

Width & depth: 460 x 520 mm

Seat height: 500 mm

Backrest height: 890 mm

Fabric: 1.1 m

Weight: 6.8 kg

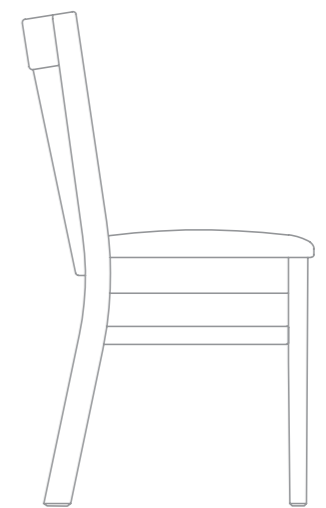



MALMO STOOL

The Malmo Stool, has an upholstered backrest that is protected by a wooden frame which provides additional support and privacy when seated. It is made from solid wood and available as a kitchen or bar stool and with a matching dining chair.

Width & depth: 455 x 500 mm

Seat height: 800 mm

Backrest height: 1075 mm

Fabric: 1.1 m

Weight: 7.3 kg

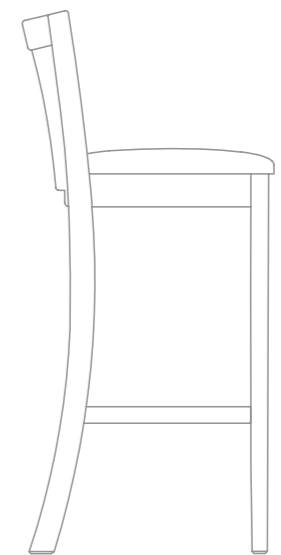



CALA CHAIR

The Cala is a comfortable dining chair with a contemporary, minimalist design, featuring clean lines and a low open backrest. Engineered for durability in robust, high-traffic environments, it includes a bottom ring for added strength. The Cala is lightweight with a small footprint and has a matching kitchen and bar stool.

Width & depth: 460 x 520 mm

Seat height: 500 mm

Backrest height: 890mm

Fabric: 0.6 m

Weight: 5.9 kg

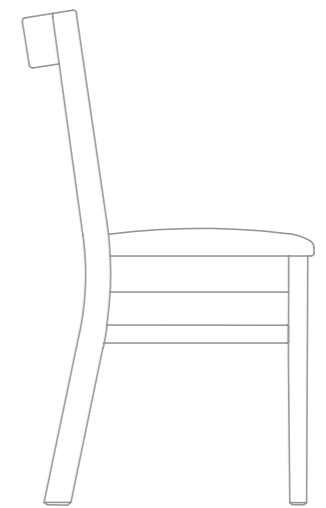





CALA STOOL

The Cala Stool, with modern minimalism in mind, features elegant lines and an open backrest.

Built for hardwearing applications, it offers a comfortable design with a small footprint, crafted from solid Ash wood. Available as a kitchen or bar stool and with a matching dining chair.

Width & depth: 455 x 500 mm

Seat height: 800 mm

Backrest height: 1075 mm

Fabric: 0.6 m

Weight: 6.6 kg

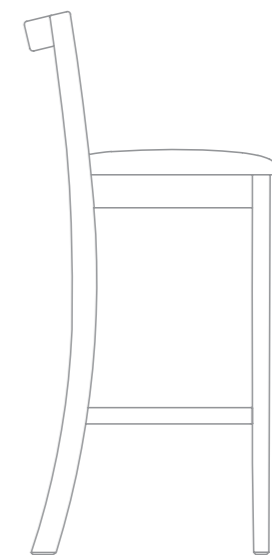



FLORO CHAIR

The Floro, a modern and luxurious dining chair, embraces gentle curves and a compact design that fits neatly under a table. Crafted from solid bentwood, the frame is very strong and offers wrap around comfort for your back.

Width & depth: 600 x 650 mm

Seat height: 490 mm

Arm height: 510 mm

Backrest height: 895 mm

Fabric: 3.3 m

Weight: 10.4 kg

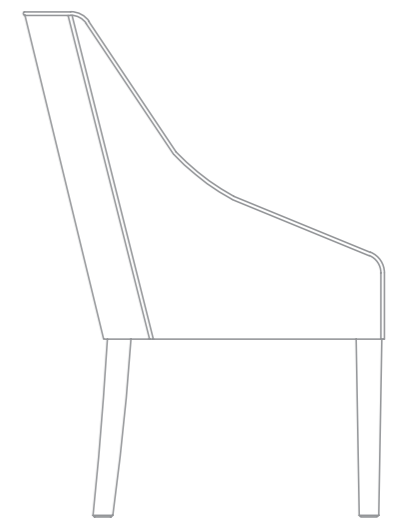





ODEN TUB CHAIR

The Oden Tub is a compact and contemporary chair, complemented by gentle rounded details. It features a distinctive back cushion with a horizontal stitch detail, adding a modern touch. Made from solid Ash wood, it provides strength and durability to the elegant design.

Width & depth: 680 x 680 mm

Seat height: 490 mm

Arm height: 680 mm

Backrest height: 830 mm

Fabric: 2.8 m

Weight: 15.1 kg

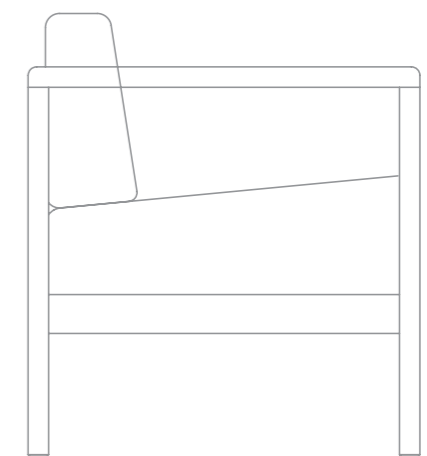





ARABELLA TUB CHAIR

The Arabella is an elegant tub chair, emphasising comfort, strength, and style. Handmade with contract applications in mind, it features a solid bentwood Ash frame beneath the upholstery, ensuring a compact, lightweight, and durable seating option.

Width & depth: 700 x 740 mm

Seat height: 440 mm

Arm height: 660 mm

Backrest height: 890 mm

Fabric: 2.7 m

Weight: 12.2 kg

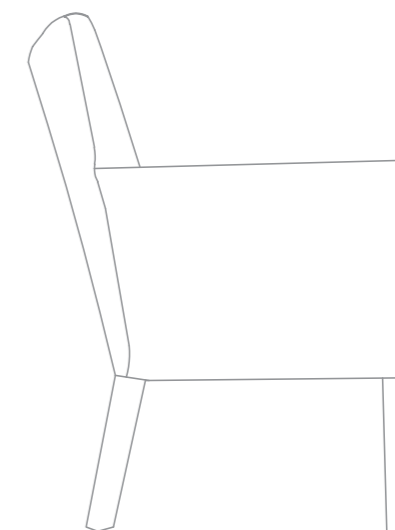



SALSA OTTOMAN

The Salsa Ottoman is a versatile, compact, and strong piece that serves as additional seating, a footstool or a side table. Made from solid Ash wood, it features piping detail on the seat, often highlighted with a contrasting fabric, and a distinctive 360-degree bentwood ring at the bottom.

Width & depth: 440 x 440 mm

Seat height: 470 mm

Fabric: 1.1 m

Weight: 5.3 kg



SPECIFICATIONS



Abbey Chair

Width & depth: 505 x 475 mm
Seat height: 480 mm
Backrest height: 815 mm
Fabric: 0.6 m
Weight: 5 kg

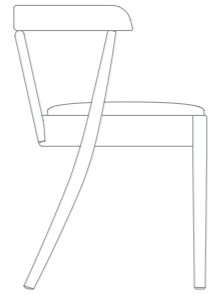

Alta Chair

Width & depth: 500 x 510 mm
Seat height: 490 mm
Arm height: 730 mm
Backrest height: 730 mm
Fabric: 0.6 m
Weight: 6 kg



Cala Chair

Width & depth: 460 x 520 mm
Seat height: 500 mm
Backrest height: 890 mm
Fabric: 0.6 m
Weight: 5.9 kg

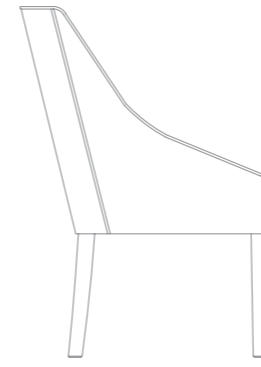

Floro Chair

Width & depth: 600 x 650 mm
Seat height: 490 mm
Arm height: 510 mm
Backrest height: 895 mm
Fabric: 3.3 m
Weight: 10.4 kg



Flynn Chair

Width & depth: 550 x 600 mm
Seat height: 460 mm
Arm height: 640 mm
Backrest height: 780 mm
Fabric: 0.6 m
Weight: 5.5 kg



Henley Chair

Width & depth: 460 x 500 mm
Seat height: 475 mm
Backrest height: 900 mm
Fabric: 0.6 m
Weight: 4.9 kg

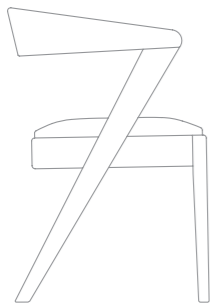

Kariba Chair

Width & depth: 550 x 510 mm
Seat height: 475 mm
Arm height: 710 mm
Backrest height: 750 mm
Fabric: 0.6 m
Weight: 7.2 kg



Lina Chair

Width & depth: 550 x 555 mm
Seat height: 460 mm
Arm height: 640 mm
Backrest height: 750 mm
Fabric: 0.6 m
Weight: 5.3 kg

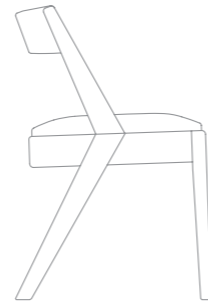

Makuti Chair

Width & depth: 525 x 500 mm
Seat height: 470 mm
Backrest height: 730 mm
Fabric: 0.6 m
Weight: 6.3 kg



Malmo Chair

Width & depth: 460 x 520 mm
Seat height: 500 mm
Backrest height: 890 mm
Fabric: 1.1 m
Weight: 6.8 kg



Riga Chair

Width & depth: 500 x 510 mm
Seat height: 490 mm
Arm height: 730 mm
Backrest height: 730 mm
Fabric: 0.6 m
Weight: 6 kg

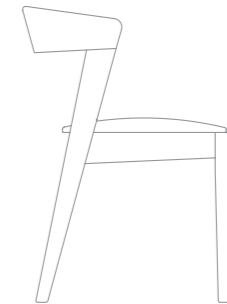

Vuti Chair

Width & depth: 500 x 530 mm
Seat height: 470 mm
Arm height: 730 mm
Backrest height: 760 mm
Fabric: 0.6 m
Weight: 5.9 kg

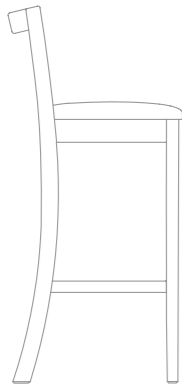

Cala Kitchen Stool

Width & depth: 455 x 500 mm
Seat height: 700 mm
Backrest height: 970 mm
Fabric: 0.6 m
Weight: 6 kg

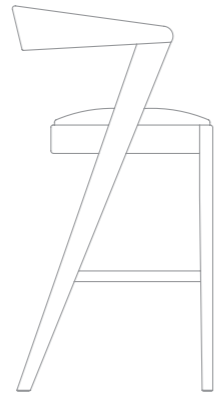

Kariba Kitchen Stool

Width & depth: 550 x 550 mm
Seat height: 690 mm
Arm height: 910 mm
Backrest height: 970 mm
Fabric: 0.6 m
Weight: 8.8 kg

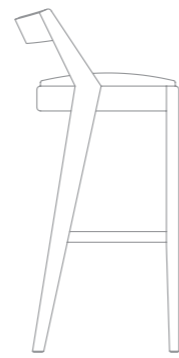

Makuti Kitchen Stool

Width & depth: 455 x 470 mm
Seat height: 685 mm
Backrest height: 860 mm
Fabric: 0.6 m
Weight: 7 kg



Malmo Kitchen Stool

Width & depth: 455 x 500 mm
Seat height: 700 mm
Backrest height: 970 mm
Fabric: 1.1 m
Weight: 6.7 kg

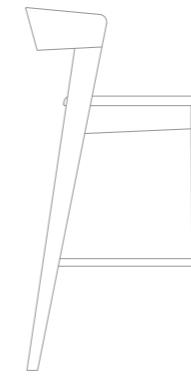

Vuti Kitchen Stool

Width & depth: 490 x 540 mm
Seat height: 690 mm
Arm height: 890 mm
Backrest height: 920 mm
Fabric: 0.6 m
Weight: 7.2 kg

Cala Bar Stool

Width & depth: 455 x 500 mm
Seat height: 800 mm
Backrest height: 1070 mm
Fabric: 0.6 m
Weight: 6.6 kg

Kariba Bar Stool

Width & depth: 550 x 550 mm
Seat height: 790 mm
Arm height: 1010 mm
Backrest height: 1070 mm
Fabric: 0.6 m
Weight: 9.4 kg

Makuti Bar Stool

Width & depth: 455 x 470 mm
Seat height: 785 mm
Backrest height: 960 mm
Fabric: 0.6 m
Weight: 7.6 kg

Malmo Bar Stool

Width & depth: 455 x 500 mm
Seat height: 800 mm
Backrest height: 1070 mm
Fabric: 1.1 m
Weight: 7.3 kg

Vuti Bar Stool

Width & depth: 490 x 540 mm
Seat height: 790 mm
Arm height: 990 mm
Backrest height: 1020 mm
Fabric: 0.6 m
Weight: 7.8 kg

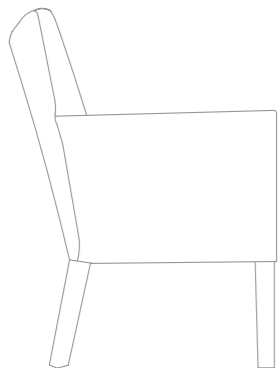

Arabella Tub Chair

Width & depth: 700 x 740 mm
Seat height: 440 mm
Arm height: 660 mm
Backrest height: 890 mm
Fabric: 2.7 m
Weight: 12.2 kg

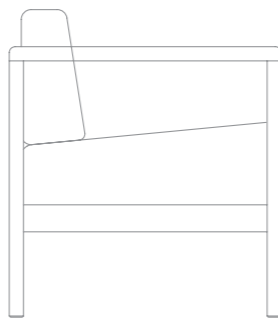

Oden Tub Chair

Width & depth: 680 x 680 mm
Seat height: 490 mm
Arm height: 680 mm
Backrest height: 830 mm
Fabric: 2.8 m
Weight: 15.1 kg



Salsa Ottoman

Width & depth: 440 x 440 mm
Seat height: 470 mm
Fabric: 1.1 m
Weight: 5.3 kg

WOODBENDER

6 van Zyl Street, Gants Plaza, Stand, 7140, South Africa

South Africa and Africa: +27 21 854 6034 | +27 11 262 0312

International: +44 1225 535700

info@woodbender.com | www.woodbender.com