

Emtron KV8 ECU

PRODUCT
DATASHEET

Rev 1.2



KV8



Contents

1.0 General.....	2
2.0 Outputs	3
3.0 Inputs	4
4.0 Lambda.....	5
5.0 Knock Control.....	5
6.0 Voltage and Ground Supplies	6
7.0 Communications	6
8.0 KV8 Pinout.....	7
8.1 Important Notes.....	11
8.2 EFI Relay Control	12
9.0 Software	13
10.0 Ordering Information.....	13
Appendix A – KV8 ECU Pinout Drawing (Rev2)	14
Appendix B – Lambda Sensor Pinout	15
Appendix C – KV Series ECU Wiring – A21	16
Appendix D – KV Series Ethernet Wiring – A24	17
Appendix E – KV Series EFI Relay Wiring – A31	18

1.0 General

Emtron's KV8 is a wire in ECU with extreme flexibility. Industry leading I/O count will ensure you do not have to make any sacrifices when configuring your engine and vehicle. This ECU will support up to 8 Channels of fuel and 8 Channels fully sequential Ignition. Every KV8 is housed in a durable billet Aluminium enclosure and includes up to 32MB permanent memory for on board logging, 4-channel oscilloscope function, DBW control up to 2 channels, dual on-board LSU4.9 Lambda controllers, dual digital Knock control, Ethernet communications and 3 axis G-force sensing to name a few.

Power Supply

- Operating voltage: 6.0 to 22.0 Volts DC (ECU shutdowns at 24.0V)
- Operating current: 390mA at 14.0V (excluding sensor and load currents)
- Reverse battery protection via external fuse
- "Smart" battery transient protection

Operating Temperature

- Max operating range: -30 to 110°C (-22 to 230°F)
- Recommended operating range: -30 to 85°C (-22 to 185°F)

Physical

- Aluminium 6061 grade CNC billet enclosure
- Enclosure size 134 mm x 162 mm x 27 mm
- Weight: 730g
- Connector system: 120-way Super Seal waterproof connectors with gold plated contacts
 - Pin diameter: 1 mm
 - Current rating: maximum 15A per pin (wire gauge dependant)
 - Connector A: 26 pin Key 2 Super Seal
 - Connector B: 34 pin Key 2 Super Seal
 - Connector C: 34 pin Key 1 Super Seal
 - Connector D: 26 pin Key 1 Super Seal

Internal

- Dual 100MHz processors
- 500Mb DDR RAM (0.5Gb)
- 32MB ECU logging memory
 - Over 1200 channels available
 - 1Hz to 500Hz logging rate
- Oscilloscope 4-channel function with 32MB storage
 - Sampling at 100k samples/second
 - Includes Crank and Cam sensor inputs
 - Includes Digital inputs 1-4
- On-Board barometric pressure sensor
 - Range 40 - 115.0 kPa
- 3-Axis accelerometer
 - 16-Bit resolution
 - $\pm 2g/\pm 4g/\pm 8g$ dynamically selectable full-scale
 - Output data rate 500Hz

2.0 Outputs

8x Port Injector Outputs—high or low ohm

- Flyback Voltage Clamp 70V
- Independent Saturated or Peak & Hold control per channel
- 8A Peak, 4A hold, 10A Limit Injector Control
- Outputs can be used for ground switching, 6A Continuous, 10A Limit
- All outputs are short circuit and over current protected
- No Flywheel diodes (external diode(s) required for VVT control)

8x Ignition Outputs

- Open collector outputs with Logic Level outputs
- Adjustable Ignition drive current (35mA or 70mA)
- Outputs can be used for Auxiliary ground switching, 1A Continuous, 3A Limit
- All outputs are short circuit and over current protected
- No Flywheel diodes (external diode(s) required for VVT control)
- Ignitor must be used between ECU and coil

16x Auxiliary Outputs

- Variable Valve Timing (VVT) and Variable Valve Timing Electric (VTiE), Drive by Wire (DBW) up to 2 throttle bodies, dual boost control, gearshift solenoids, stepper motor and many more.
- All outputs have PWM control, maximum frequency = 15 kHz
- Flywheel diodes integrated into all outputs
 - Auxiliary 1-8 Flywheel to the “ECU Supply” pin D1 connector D
 - Auxiliary 9-12 Flywheel to the “ECU 9-12 Supply” pin D20 connector D
 - Auxiliary 13-16 Flywheel to the “ECU 13-16 Supply” pin D2 connector D
- All outputs are short circuit and over current protected

Low Side Drivers

- Auxiliary 1-4: Low Side 4A continuous, 6A peak modulated, 8A limit
- Auxiliary 5-8: Low Side 2.5A continuous, 4A peak modulated, 5A limit

High Side Drivers

- Auxiliary 1-8: High Side 4A continuous, 9A limit

Half Bridge Drivers

- Auxiliary 9-12: Half Bridge 5A continuous and 8A limit. Can be used as Low Side, High Side or together for DC motor control (DBW up to 2x channels)
- Auxiliary 13-16: Half Bridge 15.0A continuous (pin limited). Can be used as Low Side or High Side.

1x EFI Relay Output

- Low Side Driver for relay control. Current limited to 200mA (Output will switch ON when Ignition Switch Input (D15) is greater than 4V).

1x Analog Output Buffered

- Voltage range 0.0 - 5.0V, output current 100mA

1x Shield Output

- Connection for Trigger and Knock shielded cables. Short to battery protection

3.0 Inputs

16x Analog Voltage/Temperature Inputs.

- Fully configurable including custom calibrations
- Switchable 1k ohm pull-up resistors on ANV 7-12 (available on 6 channels)
- Accepts a 0.0 - 5.000V analog input range. Resolution is 1.22mV (12-Bit)
- Input Impedance 100k Ohms to ground
- 160Hz Low pass filter

8x Digital/Speed Inputs (DI 1 - 8)

- Frequency range from 0.0Hz up to 30.0kHz on all 8 channels
- Magnetic and hall/optical effect sensor compatible with programmable trigger edge(s)
- Independent programmable frequency-based arming threshold control, range 0.0 - 12.0V
- Wheel speed, output shaft speed, turbo speed and other frequency-based signals
- VVT position(s) up to 4 channels available on DI 1- 4.
- Accepts a 0.0 - 20.0V analog input. Effective resolution is 4.88mV (10-Bit)
- On/Off switched inputs: AC request, launch enable, cruise switch, table control switching etc with programmable switch-based arming threshold control, range 0.0 - 20.0V
- Switchable 4k7 ohm pull-up resistors on all 8 channels to 10.0V
- Maximum/Minimum input signal amplitude +/- 80V

6x Digital/Switched Inputs (DI 9 - 14)

- On/Off switched inputs: AC request, Launch enable, cruise switch, table control switching etc with programmable switch-based arming threshold control, range 0.0 - 20.0V
- Accepts a 0.0 - 20.0 V analog input. Effective resolution is 19.61mV (8-Bit)
- Switchable 4k7 ohm pull-up resistors on all 6 channels to 10.0V

1x Dedicated Ignition Switch Input

- 6.0 - 20.0V input used for EFI Relay Control. (With input > 4V the EFI Relay output (D9) will switch ON)

2x Crank Index and Sync Engine Decoding Inputs

- Magnetic and Hall effect sensor compatible with programmable trigger edge(s)
- "True" zero crossing detection on magnetic signals for precise engine position decoding.
- Programmable independent arming threshold control from 0.1V to 12.0V
- Switchable 4k7 ohm pull-up resistor to 5V
- OEM patterns supported
- Maximum input signal amplitude +/- 80V
- Input Impedance 39k ohms to ground

4.0 Lambda

This ECU supports on-board dual Lambda controllers using the Bosch LSU4.9 wide band oxygen sensor.

2x Lambda channels supporting the Bosch LSU 4.9 sensor

- Using Bosch integrated circuit technology for precise sensor control
- Nernst cell temperature measurement for dynamic PID closed loop heater control
- Lambda range: 0.580 La to 10.000 La
- Diagnostics available for each pin and includes, Short to ground, Short to Vbat, Open Load

5.0 Knock Control

This ECU supports dual Knock control using inputs from a piezoelectric sensor. Each knock input is fully differential, giving superior common-mode noise rejection in the harsh automotive environment.

2x Knock Inputs

- 2 Independent knock input channels
- Using Bosch, Digital Knock Integrated Circuit Technology with programmable digital filter coefficients
- Center frequency configurable from 500Hz - 25kHz
- Bandwidth window from 100Hz - 5kHz
- Digital filter window; Hamming or Blackman
- Gain control(x1, x2, x4, x8)
- Cylinder selectable knock input
- Knock control available on ALL Ignition modes (Direct, Wasted, Distributor etc)

6.0 Voltage and Ground Supplies

1x ECU Supply Input

- 15.0A Max (pin limited)
- 6V - 22.0V Range
- Supplies ECU power
- Supplies Auxiliary 1-8 High Side Drivers

1x Auxiliary 9-12 Supply Input

- 15.0A Max (pin limited)
- Power supply for Auxiliary channels 9 -12. (See KV Series Power Distribution Wiring - A10.pdf for more information on how this should be wired)

1x Auxiliary 13-16 Supply Input

- 15.0A Max (pin limited)
- Power supply for Auxiliary channels 13 -16. See KV Series Power Distribution Wiring - A10.pdf for more information on how this should be wired)

2x 5.0V Sensor Supply

- 5V Vref1 output current 400mA
- 5V Vref2 output current 400mA
- Accuracy: +/- 1.0% at 25 °C
- Short circuit, Reverse Battery Protection, Thermal overload protection
- Operating temperature range -40°C ~ 125°C

1x 8.0V Sensor Supply

- Output current 600mA
- Accuracy: +/- 1.0% at 25 °C
- Short circuit, Reverse battery protection, Thermal overload protection
- Operating temperature range -40°C ~ 125°C

4x ECU Main Grounds

- 15.0A per pin, total 60A

2x Sensor 0V Reference

- Analog Sensor 0V Reference with short to battery protection

NOTE: The **Sensor 0V Reference** pin(s) are specialised ground outputs for all analog sensors. Connect direct to the sensor 0V pin, **DO NOT** connect to the Engine Block or ECU Ground.

7.0 Communications

- 1x High Speed Ethernet 100Mbps for tuning software connection
- 2x CAN 2.0B 1Mbps/ 6 Channels per node, total 128 messages

8.0 KV8 Pinout

Connector A: Lambda.

(15.0A Max continuous current - wire gauge dependant)

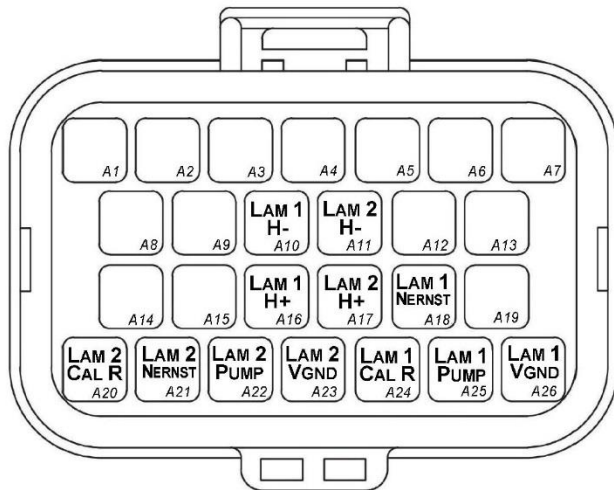

CONNECTOR A

Looking into ECU connector

Pin	Channel Name
A1	NC
A2	NC
A3	NC
A4	NC
A5	NC
A6	NC
A7	NC
A8	NC
A9	NC
A10	Lambda 1 Heater -
A11	Lambda 2 Heater -
A12	NC
A13	NC
A14	NC
A15	NC
A16	Lambda 1 Heater +
A17	Lambda 2 Heater +
A18	Lambda 1 Nernst Cell (Vs)
A19	NC
A20	Lambda 2 Cal Resistor (CalR)
A21	Lambda 2 Nernst Cell (Vs)
A22	Lambda 2 Pump Cell (Ip)
A23	Lambda 2 Virtual Ground (VGnd)
A24	Lambda 1 Cal Resistor (CalR)
A25	Lambda 1 Pump Cell (Ip)
A26	Lambda 1 Virtual Ground (VGnd)

Connector B: Auxiliary Outputs /Fuel/Ignition/Ground

(15.0A Max continuous current - wire gauge dependant)

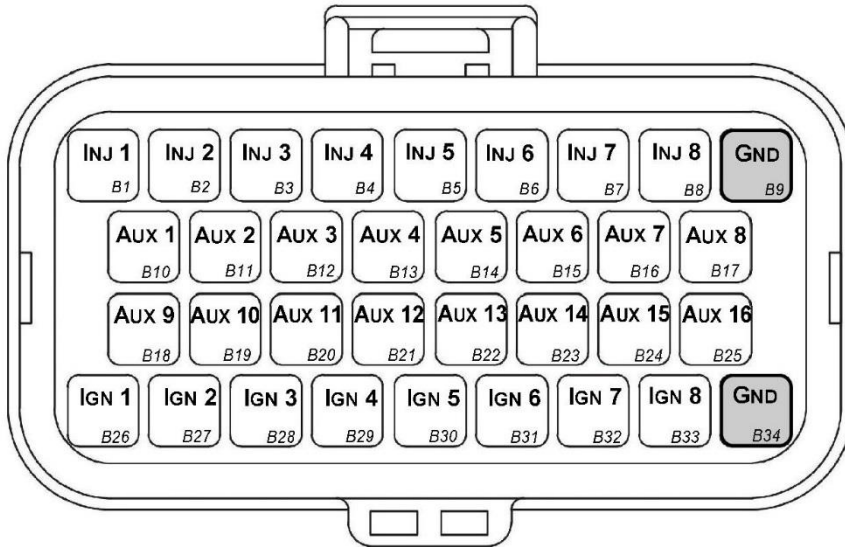

CONNECTOR B

Looking into ECU connector

Pin	Channel Name	Pin	Channel Name
B1	Injection Channel 1	B18	Auxiliary Output 9
B2	Injection Channel 2	B19	Auxiliary Output 10
B3	Injection Channel 3	B20	Auxiliary Output 11
B4	Injection Channel 4	B21	Auxiliary Output 12
B5	Injection Channel 5	B22	Auxiliary Output 13
B6	Injection Channel 6	B23	Auxiliary Output 14
B7	Injection Channel 7	B24	Auxiliary Output 15
B8	Injection Channel 8	B25	Auxiliary Output 16
B9	ECU Ground	B26	Ignition Channel 1
B10	Auxiliary Output 1	B27	Ignition Channel 2
B11	Auxiliary Output 2	B28	Ignition Channel 3
B12	Auxiliary Output 3	B29	Ignition Channel 4
B13	Auxiliary Output 4	B30	Ignition Channel 5
B14	Auxiliary Output 5	B31	Ignition Channel 6
B15	Auxiliary Output 6	B32	Ignition Channel 7
B16	Auxiliary Output 7	B33	Ignition Channel 8
B17	Auxiliary Output 8	B34	ECU Ground

Connector: C Signal.

(15.0A Max continuous current - wire gauge dependant)

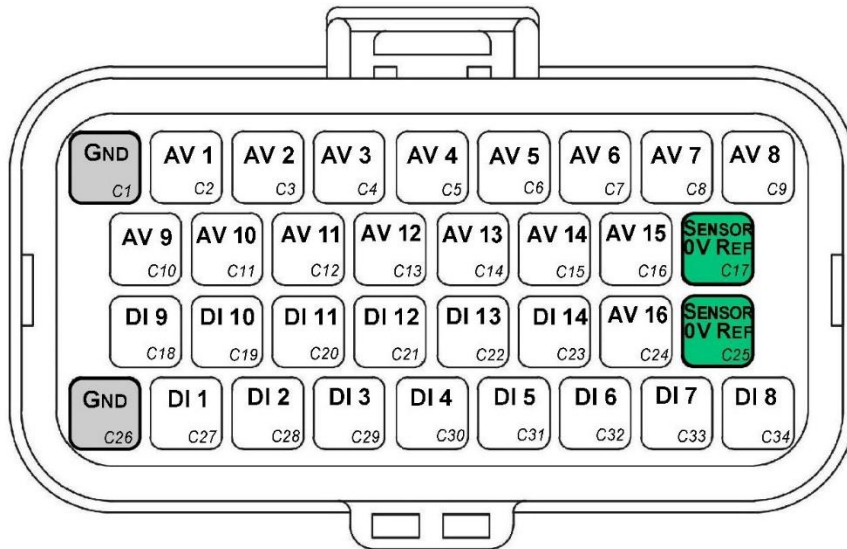

CONNECTOR C

Looking into ECU connector

Pin	Channel Name	Pin	Channel Name
C1	ECU Ground	C18	Digital Input 9
C2	Analog Input Channel 1	C19	Digital Input 10
C3	Analog Input Channel 2	C20	Digital Input 11
C4	Analog Input Channel 3	C21	Digital Input 12
C5	Analog Input Channel 4	C22	Digital Input 13
C6	Analog Input Channel 5	C23	Digital Input 14
C7	Analog Input Channel 6	C24	Analog Input Channel 16
C8	Analog Input Channel 7	C25	Analog Sensor 0V Reference
C9	Analog Input Channel 8	C26	ECU Ground
C10	Analog Input Channel 9	C27	Digital Input 1
C11	Analog Input Channel 10	C28	Digital Input 2
C12	Analog Input Channel 11	C29	Digital Input 3
C13	Analog Input Channel 12	C30	Digital Input 4
C14	Analog Input Channel 13	C31	Digital Input 5
C15	Analog Input Channel 14	C32	Digital Input 6
C16	Analog Input Channel 15	C33	Digital Input 7
C17	Analog Sensor 0V Reference	C34	Digital Input 8

Connector D: Power/Communications/Triggers/Knock

(15.0A Max continuous current - wire gauge dependant)

NOTE: See “KV8 ECU Pinout(Rev1) – Emtron” for the Rev1 ECU (Ethernet port in the back of the ECU)

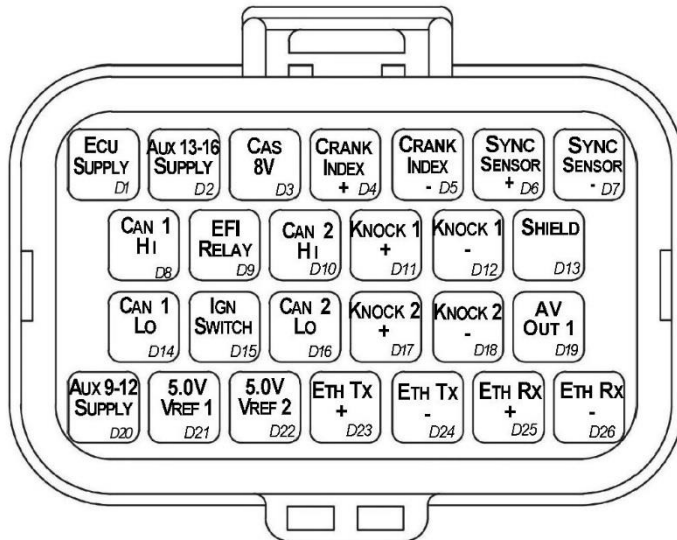

CONNECTOR D

Looking into ECU connector

Pin	Channel Name
D1	ECU 14V Supply
D2	Auxiliary Output 13-16 14V Supply
D3	Sensor Supply 8V
D4	Crank Index Sensor +
D5	Crank Index Sensor -
D6	Sync Sensor +
D7	Sync Sensor -
D8	CAN 1H
D9	EFI Relay Output (Low Side 200mA)
D10	CAN 2H
D11	Knock 1 +
D12	Knock 1 -
D13	Shield (Crank/Cam/ Knock)
D14	CAN 1L
D15	Ignition Switch Input
D16	CAN 2L
D17	Knock 2 +
D18	Knock 2 -
D19	Analog Output (0.0 - 5.0V)
D20	Auxiliary Output 9-12 14V Supply
D21	Sensor Supply Vref1: 5.0V
D22	Sensor Supply Vref2: 5.0V
D23	Ethernet Tx +
D24	Ethernet Tx -
D25	Ethernet Rx +
D26	Ethernet Rx -

8.1 Important Notes

Auxiliary Output Channels 13-16

These are high current Half bridge drivers which switch either to ground or 14V i.e. they do not have a high impedance or OFF state. When the ECU is powered OFF these Auxiliary Channels by default will be switching to ground. This means:

- 1) Solenoids or relays connected to these outputs should not use a constant or hot battery feed.
- 2) During the ECU powerup sequence, any solenoid or relay connected to these outputs should have a managed power feed to avoid momentary switching during powerup.

Analog Sensor 0V Reference (Pin C17, C25)

These pins should be connected directly to the 0V (Ground) pin on any low current analog sensor, for example Pressure or Temperature.

- **DO NOT** connect the ECU pins C17, C25 directly to the Engine Block or ECU Ground. These are dedicated and specialised ground outputs for all analog channels and should be connected directly to the sensor.
- **DO NOT** connect frequency-based sensors to these pins; for example, an Ethanol content sensor. The sensor 0V pin should be connected to the ECU ground.

Half Bridge Driver Power Supply Inputs (Pin D20, D2)

Pin D20 is a dedicated power supply for Auxiliary Channels 9-12. Power must be supplied to this pin for these channels to operate correctly. In non-DBW (Drive by Wire) applications the ECU Supply power can be shared, assuming the wire gauge has a sufficient rating for the current demand. In DBW applications power to this pin **MUST** come from an ECU controlled DBW Relay.

Pin D2 is a dedicated power supply for Auxiliary Channels 13-16. Power must be supplied to this pin for these Auxiliary channels to operate correctly.

8.2 EFI Relay Control

This ECU supports the control of an EFI relay, allowing for management of its own power supply. To achieve this a dedicated Ignition Switch input and dedicated EFI Relay output are used.

When 12V is applied to the Ignition Switch input, the ECUs fixed internal circuitry switches the EFI Relay output to ground allowing Main EFI relay to switch ON, supplying power to the ECU. This functionality is controlled at a hardware level, meaning 12V at the Ignition Switch input will ALWAYS make the EFI Relay output turn ON and switch to ground.

Once powered up the ECU takes control of the EFI Relay output, operating independent of the Ignition Switch input. When the Ignition Switch input goes low (turns OFF) this triggers the ECU to enter shutdown mode, but the ECU will only switch the Main relay OFF after all critical self-checks have been completed.

It is **highly recommended** the EFI Relay system be used. By allowing the ECU to control its power supply, when the Ignition Switch input turns OFF the ECU can firstly complete critical tasks before shutting itself down (for example, DBW Self calibration and ECU Logging data storage).

See **Appendix E** for specific wiring information.

9.0 Software

Emtron's comprehensive Emtune™ tuning software is used to connect to the ECU.

- Microsoft Windows™ 7 -10 compatible
- Free licence
- Memory requirements: 0.5GB RAM
- ECU connection using Ethernet, IPV4 protocol
- Tuning and data analysis
- PC and ECU data logging
- Live pause and data playback
- Advanced tuning functions
- Diagnostics
- Oscilloscope display

10.0 Ordering Information

Product	Part Number
Emtron KV8 ECU	1122-082
Emtron Ethernet Tuning Cable (1.5m)	553-15
Emtron Communications Cable, Superseal to Emtron Connector 200mm	533-02

Appendix B – Lambda Sensor Pinout

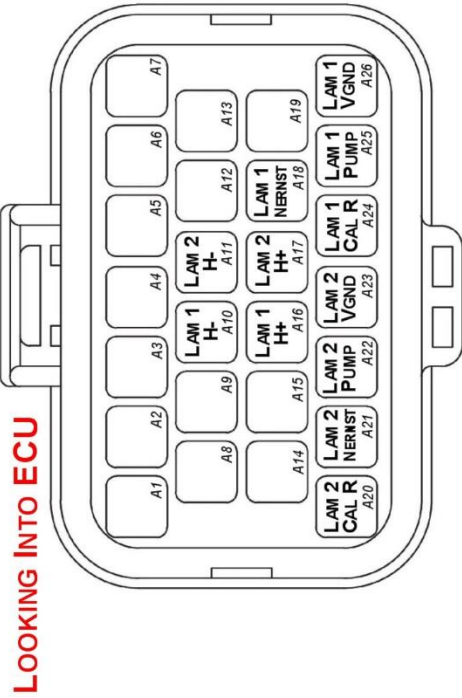
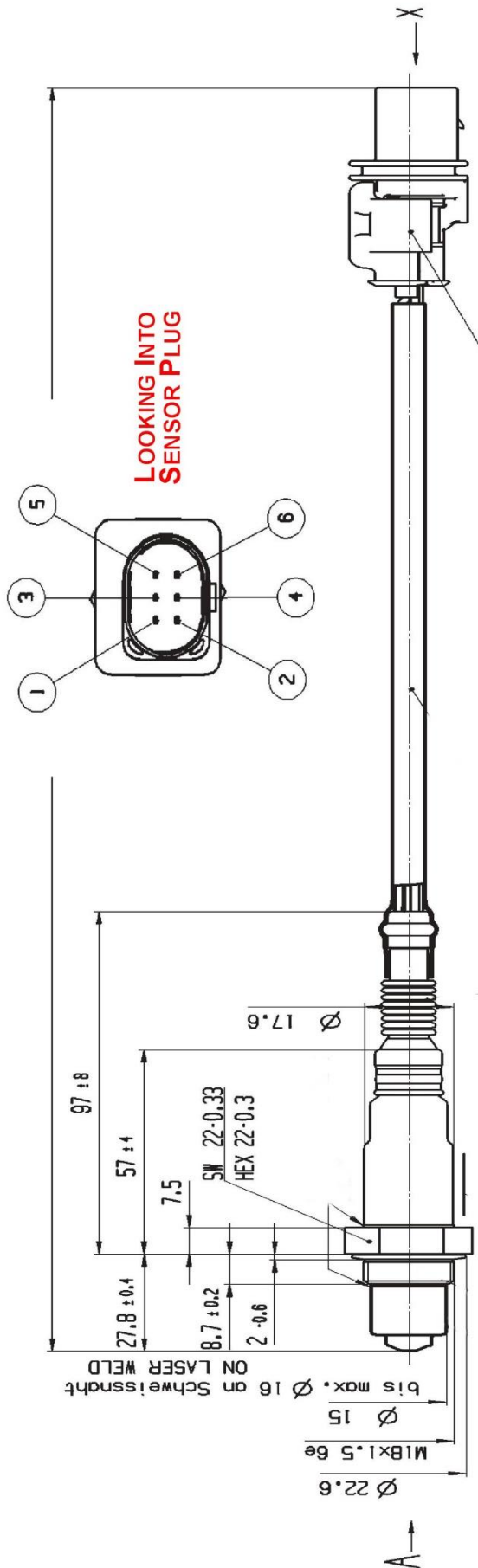

	Lam 1 ECU Pin Number	Lam 2 ECU Pin Number
Pin 1 Ip	A25	A22
Pin 2 Gnd	A26	A23
Pin 3 H-	A10	A11
Pin 4 H+	A16	A17
Pin 5 CalR	A24	A20
Pin 6 Vs	A18	A21

= Pump Current
 = Virtual Ground
 = Heater -
 = Heater +
 = Cal Resistor
 = Nernst Cell Voltage

Appendix C – KV Series ECU Wiring – A21

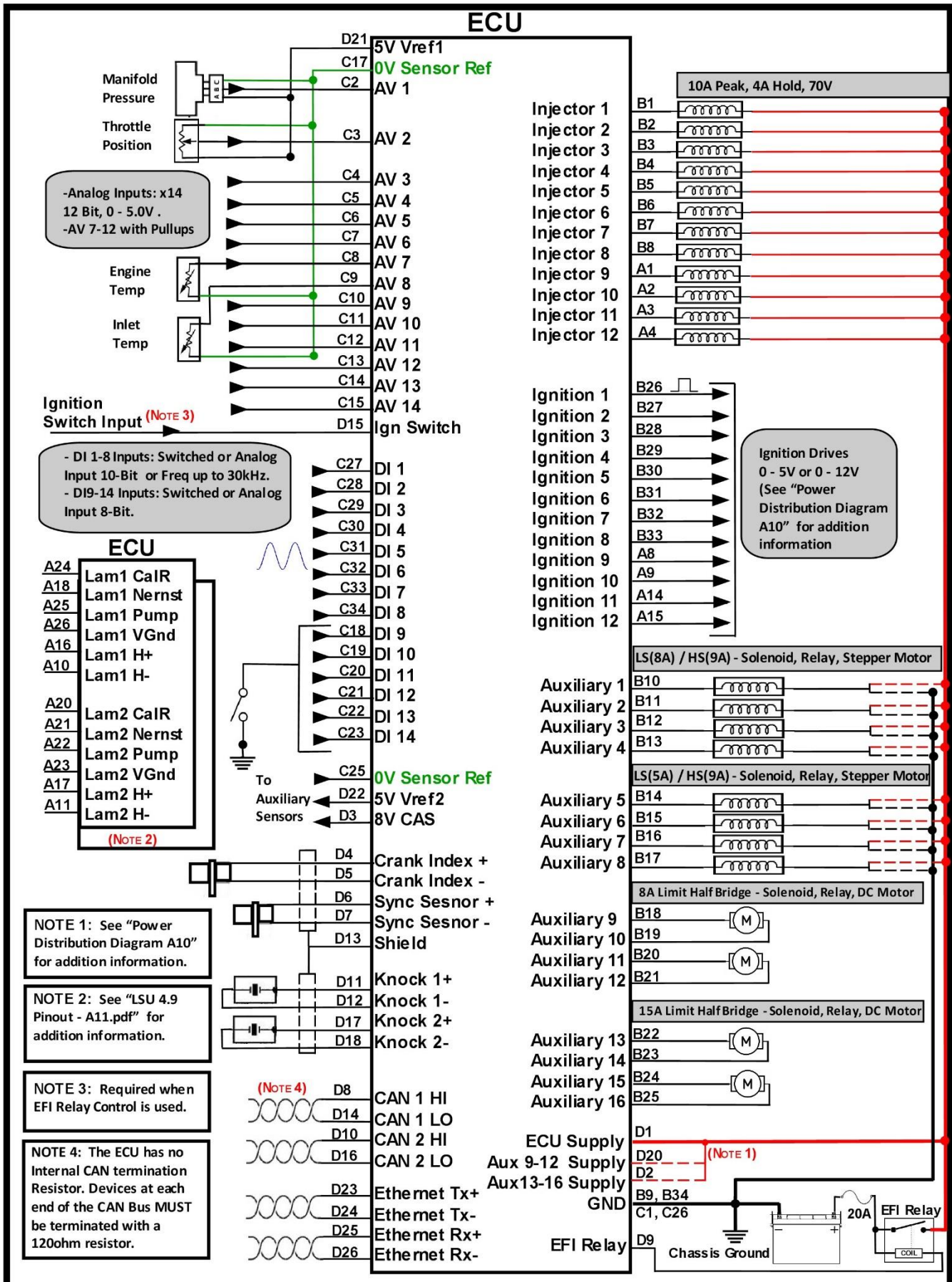

Appendix D – KV Series Ethernet Wiring – A24



Emtron Ethernet Pinout

RJ45 Pin	Emtron Pin	Description	Wire Colour / Cat 5e Standard
1	D23	Ethernet Tx +	white/green
2	D24	Ethernet Tx -	green
3	D25	Ethernet Rx +	white/orange
6	D26	Ethernet Rx -	orange



Title: KV Series Ethernet Pinout

Date: 08/05/2018 Revision: 1.1

Drawing Number: A24

Appendix E – KV Series EFI Relay Wiring – A31

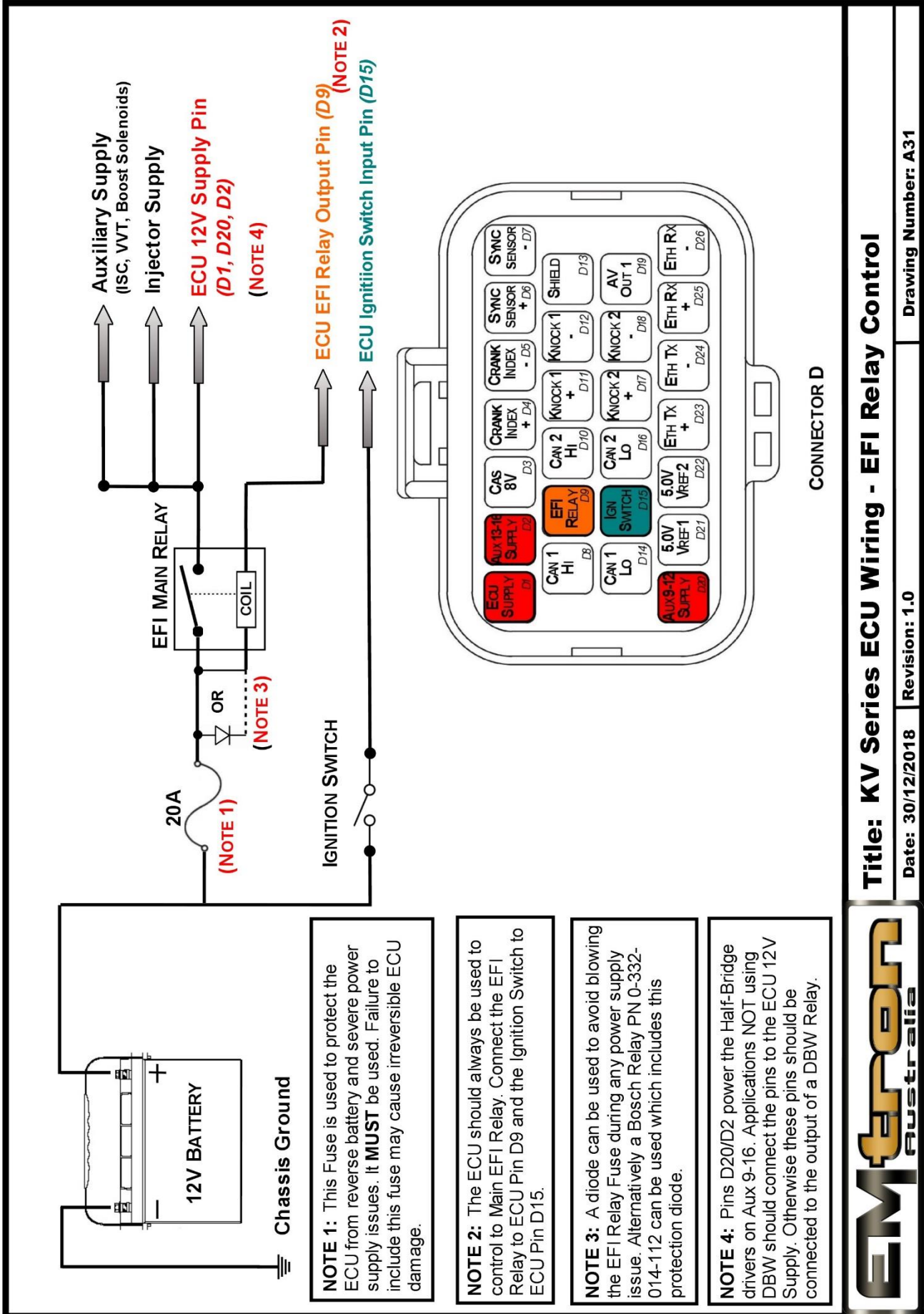

Title: KV Series ECU Wiring - EFI Relay Control

Date: 30/12/2018 Revision: 1.0

Drawing Number: A31



Emtron Australia Pty Ltd
Unit 8, 36 Lidco Street
Arndell Park NSW 2148
Australia

(See the www for contact information)

www.emtron.world

www.emtronaustralia.com.au