

PHOENIX 200

Portable Power Station

Version A0



APPLICABILITY

The User Manual applies to the following product:

- PHOENIX 200 Portable Power Station (RPS2220AA)

DISCLAIMER

- Renogy makes no warranty as to the accuracy, sufficiency, or suitability of information in the User Manual because continuous product improvements are going to be made.
- Renogy assumes no responsibility or liability for losses or damages, whether direct, indirect, consequential, or incidental, which might arise out of the use of information in the User Manual.
- Renogy is not responsible or liable for the failures, damages, or injuries resulting from repair attempted by unqualified personnel or improper installation and operation.
- The illustrations in the User Manual are for demonstration purposes only. Details may appear slightly different depending on product revision and market region.
- Renogy reserves the right to change the information in the User Manual without notice.

COPYRIGHT

- PHOENIX 200 Portable Power Station User Manual © 2022 Renogy. All rights reserved.
- All information in the User Manual is subject to copyright and other intellectual property rights of Renogy and its licensors. The User Manual may not be modified, reproduced, or copied, in whole or in part, without the prior written permissions of Renogy and its licensors.

TRADEMARKS

The following are trademarks or registered trademarks of Renogy in the United States and other countries:



All other trademarks in the User Manual are the property of their respective owners and their use herein does not imply sponsorship or endorsement of their products or services. The unauthorized use of any trademark displayed in the User Manual or on the product is strictly prohibited.

Important Safety Instructions

Please save these instructions.

The User Manual provides important operation and maintenance instructions for PHOENIX 200 Portable Power Station. Please read the User Manual carefully before operation and save it for future reference. Failure to observe the instructions or precautions in the User Manual can result in electrical shock, serious injury, or death, or can damage PHOENIX, potentially rendering it inoperable.

Symbols Used

The following symbols are used throughout the User Manual to highlight important information.

WARNING

Indicates a potentially dangerous condition which could result in injury or death.

CAUTION

Indicates a critical procedure for safe and proper installation and operation.

NOTE

Indicates an important step or tip for optimal performance.

General Safety Information

WARNING

- DO NOT immerse PHOENIX in water or leave it out in the rain.
- DO NOT puncture, drop, crush, penetrate, shake, strike, or step on PHOENIX.
- DO NOT open, dismantle, repair, tamper with, or modify PHOENIX.
- DO NOT insert foreign objects into the casing or outlets of PHOENIX.
- Please remove all connections and turn PHOENIX off before cleaning it.
- DO NOT expose PHOENIX to direct flame.
- Please keep PHOENIX away from flammable or combustible materials.
- Please keep PHOENIX away from heating equipment.
- DO NOT touch the exposed electrolyte or powder if PHOENIX is damaged.
- DO NOT use PHOENIX with life support equipment or other medical equipment.
- DO NOT touch the exposed electrolyte or powder if PHOENIX is damaged.
- DO NOT use PHOENIX with life support equipment or other medical equipment.
- Please keep PHOENIX out of the reach of young children.
- DO NOT dispose of PHOENIX as household waste. Please recycle PHOENIX in accordance with local, state, and federal regulations.
- Please inspect PHOENIX before each use. Stop using PHOENIX if any visible damages including cracks, dents, and deformation or abnormalities including unusual smells and heating are observed.

CAUTION

- Please use PHOENIX in accordance with its input and output specifications.
- DO NOT expose PHOENIX to flammable or harsh chemicals or vapors.
- DO NOT expose PHOENIX to strong electrostatic fields, strong magnetic fields, or radiation.
- Please ensure that no water sources including downspouts, sprinklers, or faucets are above or near PHOENIX.
- Please ensure that snow does not accumulate around PHOENIX.
- DO NOT lean on, stack anything on top of, or hang anything from PHOENIX or from cables leading to PHOENIX.
- Please ensure that PHOENIX is securely fastened during transportation.

Table of Contents

Product Overview	05
Identification of Parts	05
Package Content	06
LCD Display	07
Operation	09
Turning On/Off	09
Charging	09
Powering Devices	12
Timeout Settings	14
Maintenance	15
Cleaning	15
Storage	15
Troubleshooting	16
Specifications	20

Product Overview

Identification of Parts

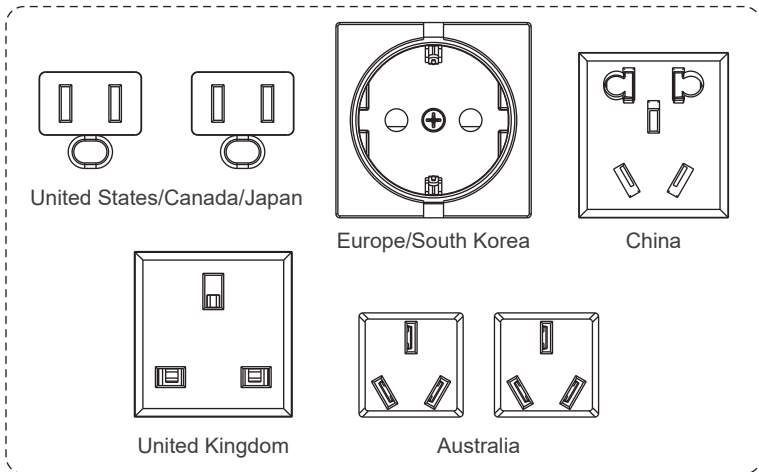
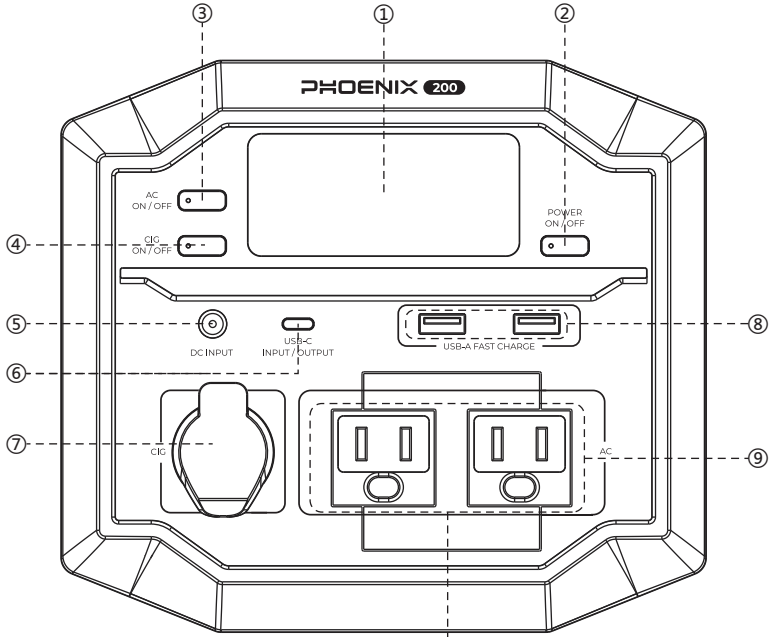

- ① LCD Display
- ② Power On/Off Button
- ③ AC On/Off Button
- ④ CIG On/Off Button
- ⑤ DC Input Port
- ⑥ USB-C Input/Output Port
- ⑦ CIG Port
- ⑧ USB-A Fast Charge Ports
- ⑨ AC Outlet(s)

■ Package Content

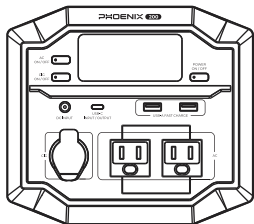

PHOENIX 200
Portable Power Station

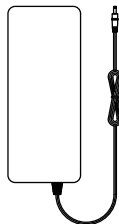

AC Adapter



AC Power Cable



Car Charge Cable

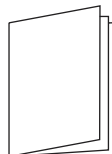





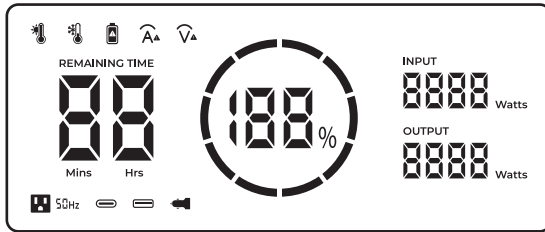

User Manual

LCD Display



Icon	Name	Description
	Battery Level	Indicates the current battery level. As the PHOENIX charges, the ring will light up clockwise with the increasing percentage, and the endmost ring segment will fast flash. Once PHOENIX is fully charged, all the ring segments will light up and remain solid. As the PHOENIX discharges, the ring will go out counter-clockwise. When the battery level drops below 10%, the last ring segment will slow flash.
	Input Power	Indicates the amount of power going into PHOENIX.
	Output Power	Indicates the amount of power going out of PHOENIX.
	Remaining Time	Indicates the amount of time before PHOENIX is completely charged or discharged. When PHOENIX idles, the remaining time will show 99 hours.
	AC Outlet Status	Indicates the on/off status and output frequency of the AC Outlet(s).
	USB-C Port Status	Indicates the usage status of the USB-C Port.
	USB-A Port Status	Indicates the usage status of the USB-A Fast Charge Ports.

Icon	Name	Description
	CIG Port Status	Indicates the on/off status of the CIG Port.
	High Temperature Protection	Indicates the protection related to high temperatures.
	Low Temperature Protection	Indicates the protection related to low temperatures.
	Battery Protection	Indicates the protection related to the internal battery.
	Current Protection	Indicates the protection related to current.
	Voltage Protection	Indicates the protection related to voltage.

CAUTION

- PHOENIX might need special attention if the [High Temperature Protection], [Low Temperature Protection], [Battery Protection], [Current Protection], or [Voltage Protection] icon appears. Please refer to the Troubleshooting section for detailed instructions.

Operation

Turning On/Off

- Short press the Power On/Off Button to turn on PHOENIX. The LCD Display will light up to display the operating status of PHOENIX.
- Long press the Power On/Off Button for 3 seconds to turn off PHOENIX. The LCD Display will go out.

Charging

WARNING

- DO NOT charge PHOENIX at high temperatures above 131°F (55°C) or low temperatures below 32°F (0°C). The recommended charge temperature range is between 32°F (0°C) and 104°F (40°C).
- DO NOT use damaged accessories to charge PHOENIX as it might cause electric shock.

CAUTION

- ONLY use Renogy approved accessories to charge PHOENIX.
- DO NOT charge PHOENIX immediately after a long heavy run.
- Please charge PHOENIX immediately when the battery level drops below 10% to prevent overdischarge.

NOTE

- To extent the cycle life, please fully charge PHOENIX before each use.
- It is not required to turn on PHOENIX manually before charging. PHOENIX turns on automatically once it detects the charging source(s).

PHOENIX features 4 charging methods – solar, AC, car, and USB-C. AC charging and USB-C charging can be combined for a faster charging speed.

Solar Charging

- Place a solar panel (sold separately) under direct sunlight. Steer clear of objects that can shade the solar panel and slow down the charging process.
- Connect the DC Input Port of PHOENIX to the solar connectors of the solar panel with a solar charge cable (sold separately). PHOENIX will start charging automatically.

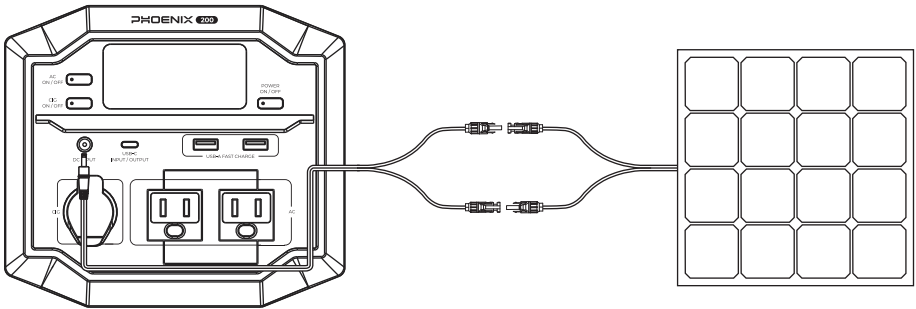

CAUTION

- The operating voltage of the solar panel shall exceed 10V, and the open circuit voltage shall NOT exceed 25V.
- DO NOT connect multiple solar panels in series.

NOTE

- PHOENIX automatically limits the input power. It is allowed and recommended to charge PHOENIX with a solar panel rated above 60W to account for the energy conversion loss.
- For optimal charging performance, it is recommended to charge PHOENIX with the solar panel on bright sunny days free of clouds.
- The solar charge time is highly dependent on the solar irradiance and the ambient temperature.

AC Charging

- Plug the included AC Power Cable into the included AC Adapter.
- Connect the DC Input Port of PHOENIX to a wall outlet with the AC Power Cable and AC Adapter. PHOENIX will start charging automatically.

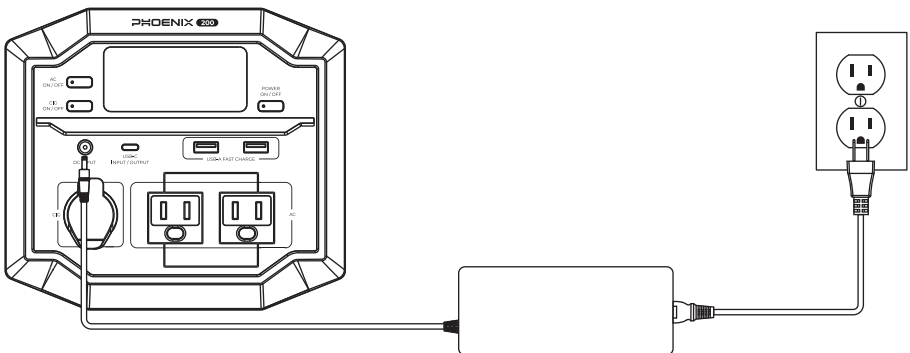

Car Charging

- Start the car engine.
- Connect the DC Input Port of PHOENIX to the CIG port in the car with the included Car Charge Cable. PHOENIX will start charging automatically.

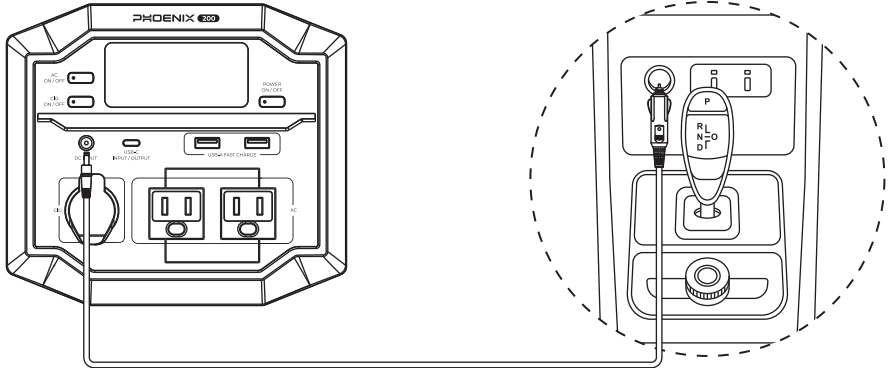

CAUTION

- Please ensure that the car battery is 12V. The 24V car battery might damage PHOENIX.

USB-C Charging

- Plug a USB-C cable (not included) into a USB-C charger (not included).
- Connect the USB-C Input/Output Port of PHOENIX to a wall outlet with the USB-C cable and USB-C charger. PHOENIX will start charging automatically.

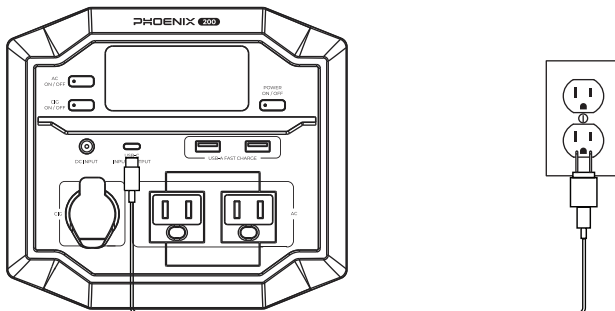

NOTE

- For optimal charging performance, it is recommended to charge PHOENIX with a high power USB-C charger that supports the Power Delivery (PD) standard.

Powering Devices

WARNING

- DO NOT discharge PHOENIX at high temperatures above 140°F (60°C) or low temperatures below -4°F (-20°C). The recommended discharge temperature range is between 23°F (-5°C) and 113°F (45°C).

CAUTION

- PHOENIX can provide a total output power of up to 278W. Please allocate the output power rationally. DO NOT overload PHOENIX.
- DO NOT connect high power devices to PHOENIX when it is running low.

NOTE

- It is required to turn on PHOENIX manually before powering devices.
- When the PHOENIX is overloaded, it will reduce the output power of the USB-C Input/Output Port and turn off the USB-C Input/Output Port, USB-A Fast Charge Ports, CIG Port and AC Outlets in sequence until the total output power drops below 278W.
- PHOENIX might not be able to deliver exact 222Wh energy when powering high power devices

PHOENIX provides 4 kinds of output ports for the devices – USB-A fast charge, USB-C, CIG, and AC.

USB-A/USB-C Devices

- Connect the device(s) directly to the USB-A Fast Charge Ports or USB-C Input/Output Port with PHOENIX on. The USB-A Fast Charge Ports or USB-C Input/Output Port will automatically turn on to power the device.
- Disconnect the device(s) from the USB-A Fast Charge Ports or USB-C Input/Output Port. The USB-A Fast Charge Ports or USB-C Input/Output Port will turn off automatically.
- The USB-A Fast Charge Ports can power most USB-A devices including smart watch, electronic book, smartphone, tablet, action camera, digital camera, Bluetooth speaker, wireless headphone, and drone.
- The USB-C Input/Output Port can power most USB-C devices including smartphone, tablet, laptop, handheld game console and DSLR camera.

NOTE

- When both the USB-A Fast Charge Ports are in use, the fast charge function will be disabled.
- To get up to 18W output power from the USB-A Fast Charge Port, the connected device must support the Quick Charge (QC) standard.
- To get up to 60W output power from the USB-C Input/Output Port, the connected device must support the Power Delivery (PD) standard.

Car Powered Devices

- Short press the CIG On/Off Button with PHOENIX on to turn on the CIG Port. Connect the device to the CIG Port. The CIG Port will start powering the device.
- Long press the CIG On/Off Button for 3 seconds to turn off the CIG Port. The CIG Port will stop powering the device.
- The CIG Port can power most car powered devices including portable refrigerator, car vacuum, car air fan, and CPAP machine.

AC Devices

- Short press the AC On/Off Button with PHOENIX on to turn on the AC Outlets. Connect the devices to the AC Outlets. The AC Outlets will start powering the devices.
- Long press the CIG On/Off Button and AC On/Off Button at the same time for 3 seconds with the AC Outlets on to switch the output frequency of the AC Outlets between 50Hz and 60Hz.
- Long press the AC On/Off Button for 3 seconds to turn off the AC Outlets. The AC Outlets will stop powering the devices.
- The AC Outlets can power most AC devices rated under 200W including laptop, monitor, TV, game console, inkjet printer, portable projector, and light bulb.

CAUTION

- Please select the output frequency of the AC Outlets in accordance with the device specifications. Inappropriate output frequency might damage the device.
- Please allow at least 4 inches (101.6 mm) of space on both sides of PHOENIX for efficient heat dissipation when the AC Outlets are in use.

NOTE

- PHOENIX might not be able to power AC devices that require high starting currents even though they are rated under 200W.

■ Timeout Settings

LCD Display Timeout

- When no operation is made for 5 minutes, the LCD Display will go out automatically to save energy.
- Short press the Power Button with PHOENIX on to light up or dim the LCD Display manually.

CIG Port Timeout

- When the device draws low or no power from the CIG Port for 1 hour, the CIG Port will turn off automatically to save energy.
- Long press the Power On/Off Button and CIG On/Off Button at the same time for 3 seconds with the CIG Port on to disable the CIG Port timeout.
- Turn off the CIG Port and turn it on again to re-enable the CIG Port timeout.

AC Outlets Timeout

- When the devices draws low or no power from the AC Outlets for 1 hour, the AC Outlets will turn off automatically to save energy.
- Long press the Power On/Off Button and AC On/Off Button at the same time for 3 seconds with the AC Outlets on to disable the AC Outlets timeout.
- Turn off the AC Outlets and turn them on again to re-enable the AC Outlets timeout.

Unit Timeout

- When PHOENIX is not charging, the USB-A Fast Charge Ports and the USB-C Input/Output Ports are not in use, and the CIG Port and AC Outlets are off for 1 hour, PHOENIX will turn off automatically to save energy.

Maintenance

■ Cleaning

- Remove all the connections from PHOENIX.
- Turn off PHOENIX.
- Clear the leaves, debris, and dust from the fans of PHOENIX.
- Clean the casing of PHOENIX with a soft dry cloth.
- Keep the area around PHOENIX clean and dry.
- Turn PHOENIX back on.
- Reconnect the devices to PHOENIX.

■ Storage





- Charge PHOENIX to 50%.
- Remove all the connections from PHOENIX.
- Turn off PHOENIX.
- Handle PHOENIX carefully to avoid sharp impacts or extreme pressure on the casing of PHOENIX.
- Store PHOENIX in a well ventilated, dry, clean area with temperatures between 32°F(0°C) and 113°F (45°C) and humidity lower than 75%.
- For long term storage, discharge PHOENIX to 30% and charge it to 50% every 6 months.
- Fully charge PHOENIX when it is taken out of the storage.





WARNING







- DO NOT expose PHOENIX to extreme temperatures above 140°F (60°F).
- DO NOT expose PHOENIX to direct sunlight, moisture, or precipitation.
- Please keep PHOENIX away from water, heat, dust, dirt, corrosives, and metal objects.
- Please ensure that no metal objects can fall on or around PHOENIX.

Troubleshooting

- If PHOENIX does not operate properly, refer to the table below for possible causes and corrective steps.
- If the corrective steps do not work, contact our customer service through renogy.com/contact-us/.

Icon	Pattern	Possible Causes	Corrective Steps
INPUT 	Slow Flash	DC Input Overvoltage/ Undervoltage	<ul style="list-style-type: none"> • Disconnect the charging source from the DC Input Port. • Check the voltage rating of the charging source. Stop using the charging source if its output voltage is rated lower than 10V or higher than 25V. • Connect the charging source with the appropriate voltage rating to the DC Input Port. Charging can be resumed.
INPUT 	Fast Flash	DC Input Reverse Polarity	<ul style="list-style-type: none"> • Disconnect the charging source from the DC Input Port. • Check the polarity of the charging source. • Connect the charging source with the correct polarity to the DC Input Port. Charging can be resumed.
	Slow Flash	USB-A Fast Charge Output Overvoltage/ Undervoltage	<ul style="list-style-type: none"> • Disconnect the devices from the USB-A Fast Charge Ports. • Reconnect the devices to the USB-A Fast Charge Ports. • Contact us for help if the icons persist.
	Slow Flash	USB-A Fast Charge Output Overcurrent/ Short Circuit	<ul style="list-style-type: none"> • Disconnect the devices from the USB-A Fast Charge Ports. • Remove the short circuits if the USB-A Fast Charge Ports are shorted. • Check the current ratings of the devices. Stop using the devices if they draw currents that exceed the specifications of the USB-A Fast Charge Ports. • Connect the devices with the appropriate current ratings to the USB-A Fast Charge Ports. Power can be resumed.

Icon	Pattern	Possible Causes	Corrective Steps
	Slow Flash	USB-C Output Overvoltage/ Undervoltage	<ul style="list-style-type: none"> • Disconnect the device from the USB-C Input/Output Port. • Reconnect the device to the USB-C Input/Output Port. • Contact us for help if the icons persist.
	Slow Flash	USB-C Output Overcurrent/ Short Circuit	<ul style="list-style-type: none"> • Disconnect the device from the USB-C Input/Output Port. • Remove the short circuit if the USB-C Input/Output Port is shorted. • Check the current rating of the device. Stop using the device if it draws current that exceeds the specification of the USB-C Input/Output Port. • Connect the device with the appropriate current rating to the USB-C Input/Output Port. Power can be resumed.
	Slow Flash	CIG Output Overcurrent/ Short Circuit	<ul style="list-style-type: none"> • Disconnect the device from the CIG Port. • Remove the short circuit if the CIG Port is shorted. • Check the current rating of the device. Stop using the device if it draws current that exceeds the specification of the CIG Port. • Short press the CIG On/Off Button with the LCD Display lit up to release the protection. • Connect the device with the appropriate current rating to the CIG Port. Power can be resumed.
	Slow Flash	AC Output Overload/ Short Circuit	<ul style="list-style-type: none"> • Disconnect the devices from the AC Outlets. • Remove the short circuit if the AC Outlets are shorted. • Check the power ratings of the devices. Stop using the devices if their power ratings are higher than 200W. • Short press the AC On/Off Button with the LCD Display lit up to release the protection. • Connect the devices with the appropriate power ratings to the AC Outlets. Power can be resumed.

Icon	Pattern	Possible Causes	Corrective Steps
 	Slow Flash	Inverter High Temperature	<ul style="list-style-type: none"> • Check if the fan inlet and outlet are blocked. • Cool down PHOENIX to the room temperature. • Short press the AC On/Off Button with the LCD Display lit up to release the protection. Power can be resumed.
OUTPUT 	Slow Flash	Total Output Overload	<ul style="list-style-type: none"> • Reallocate the output power to ensure that the total output power is under 278W. • Short press the Power On/Off Button with the LCD Display lit up to release the protection. • Disconnect and reconnect the device(s) to turn on the USB-A Fast Charge Ports or USB-C Input/Output Port again. Short press the CIG On/Off Button or AC On/Off Button to turn on the CIG Port or AC Outlets again. Power can be resumed.
 	Slow Flash	Battery High Temperature	<ul style="list-style-type: none"> • Disconnect all the connections from PHOENIX. • Check if the fan inlet and outlet are blocked. • Cool down PHOENIX to the room temperature. • Reconnect the charging source(s) to PHOENIX. Charging can be resumed. • Reconnect the device(s) to turn on the USB-A Fast Charge Ports or USB-C Input/Output Port again. Short press the CIG On/Off Button or AC On/Off Button to turn on the CIG Port or AC Outlets again. Power can be resumed.
 	Slow Flash	Battery Low Temperature	<ul style="list-style-type: none"> • Warm up PHOENIX. • Charging can be resumed automatically. • Disconnect and reconnect the device(s) to turn on the USB-A Fast Charge Ports or USB-C Input/Output Port again. Short press the CIG On/Off Button or AC On/Off Button to turn on the CIG Port or AC Outlets again. Power can be resumed.

Specifications

General	
Dimension	7.48 x 6.10 x 6.99 inch / 190 x 155 x 170 mm
Weight	5.29 lbs. / 2.4 kg
Charge Temperature	32°F~104°F / 0°C~40°C (Recommended) 32°F~131°F / 0°C~55°C (Extreme)
Discharge Temperature	23°F~113°F / -5°C~45°C (Recommended) -4°F~140°F / -20°C~60°C (Extreme)
Storage Temperature	32°F~113°F / 0°C~45°C
Battery	
Type	Lithium Ion
Capacity	14.8V, 15000mAh / 222Wh
Cycle Life	500 Cycles (80% DOD, 80% EOL)
Input	
DC Input	10V~25V \equiv 4A, 60W Max
USB-C Input	5V \equiv 3A, 9V \equiv 3A, 12V \equiv 3A, 15V \equiv 3A, 20V \equiv 3A, 60W Max
Total Input	120W Max
Output	
USB-A Fast Charge Output (x2)	5V \equiv 3A, 9V \equiv 2A, 12V \equiv 1.5A, 18W Max
USB-C Output (x1)	5V \equiv 3A, 9V \equiv 3A, 12V \equiv 3A, 15V \equiv 3A, 20V \equiv 3A, 60W Max
CIG Output (x1)	11V~17V \equiv 10A, 120W Max
AC Output (x1/x2)	100V (JP)/120V (US, CA)/220V~240V (EU, UK, AU, KR, CN) \sim 50Hz/60Hz, 200W Rated, 400W Surge
Total Output	278W Max

FCC STATEMENT

This device complies with Part 15 of the FCC Rules. Operation is subject to the following two conditions:

- (1) This device may not cause harmful interference, and
- (2) This device must accept any interference received, including interference that may cause undesired operation.

This equipment has been tested and found to comply with the limits for a Class B digital device, pursuant to Part 15 of the FCC Rules. These limits are designed to provide reasonable protection against harmful interference in a residential installation. This equipment generates uses and can radiate radio frequency energy and, if not installed and used in accordance with the instructions, may cause harmful interference to radio communications. However, there is no guarantee that interference will not occur in a particular installation. If this equipment does cause harmful interference to radio or television reception, which can be determined by turning the equipment off and on, the user is encouraged to try to correct the interference by one or more of the following measures:

- (1) Orient or relocate the receiving antenna.
- (2) Increase the separation between the equipment and receiver.
- (3) Connect the equipment into an outlet on a circuit different from that to which the receiver is connected.
- (4) Consult the dealer or an experienced radio/TV technician for help.

FCC RADIATION EXPOSURE STATEMENT

This equipment complies with FCC radiation exposure limits set forth for an uncontrolled environment. This equipment should be installed and operated with minimum distance 20cm between the radiator & your body.







eVatmaster Consulting GmbH
Battinastr. 30
60325 Frankfurt am Main, Germany
contact@evatmaster.com



EVATOST CONSULTING LTD
Suite 11, First Floor, Moy Road Business
Centre, Taffs Well, Cardiff, Wales, CF15 7QR
contact@evatmaster.com

Renogy reserves the right to change the contents of this manual without notice.



US |  5050 S Archibald Ave, Ontario, CA 91762
 909-287-7111
 www.renogy.com
 support@renogy.com

CN |  苏州高新区科技城培源路1号5号楼-4
 400-6636-695
 <https://www.renogy.cn>
 support@renogy.cn

JP |  <https://www.renogy.jp>
 supportjp@renogy.com

CA |  <https://ca.renogy.com>
 supportca@renogy.com

AU |  <https://au.renogy.com>
 supportau@renogy.com

UK |  <https://uk.renogy.com>
 supportuk@renogy.com

DE |  <https://de.renogy.com>
 supportde@renogy.com