

DARAY[®]

Medical



X350

LED Examination Light

Operating & Installation Manual

Table of Contents

1. Introduction	3
1.1 Supported Lights	4
2. Technical Specifications	5
2.1 Technical Drawing	6
2.2 Pre-Installation Responsibilities and component packing list	7
2.3 Pre-Start Checks	7
3. Operation	8
3.1 Turning the light ON/OFF and adjusting the intensity	8
3.2 Correct usage of the light	9
4. Maintenance	11
4.1 Maintenance schedule	11
4.2 Safety Precautions	11
4.3 Product cleaning & care guidelines	12
4.4 Fuse Replacement	13
4.5 Switch Replacement	14
6. Warranty Information	17
6.1 Returns Policy	17
6.2 Warranty Details	18



1. Introduction

DARAY's X350 is a cost-effective mobile medical examination light utilising LED technology.

The mobile base contains a transformer to convert the mains electrical input to a safe, low voltage which is fed to the light-head. The base is very stable and manoeuvrable, and is fitted with 2 locking and 2 free castors; it will fit underneath most couches, tables and chairs.

The X350 light-head swivels through 320° on a flexible arm on top of a telescopic up-stand, allowing the light-patch to be directed wherever it is required for examination.

DARAY's BioProtect anti-microbial coating is applied to all painted finishes including the light-head and the handle. All other surfaces are smooth to aid cleaning and sterilisation.

This user & installation guide contains all the information you need for installation, operation and maintenance.

Restrictions and Liabilities

Information in this document is subject to change and does not represent a commitment by DARAY. Changes made to the information in this document will be incorporated in new editions of the publication. No responsibility is assumed by DARAY for the use or reliability of software or equipment that is not supplied by DARAY.

For further information on our product range and find out more about our Company please visit www.daray.co.uk or call 0333 321 0971.

This product was designed & manufactured in Great Britain by:

**Daray Ltd.
Edison House
Robian Way
Swadlincote
Derbyshire
DE11 9DH**

1.1 Supported Lights

The Following Models are supported in this Manual	
X350LM	X350 LED Mobile Examination Light

2. Technical Specifications

Light Source	LED
Light Intensity (Lux) @ 0.5m	64,000 Lux ±5%
Light Intensity (Lux) @ 0.75m	30,000 Lux ±5%
Light Intensity (Lux) @ 1.0m	17,000 Lux ±5%
Light Intensity Adjustment Range	10% - 100%
Colour Temperature (Kelvin)	4,300K ±500
Colour Rendering Index (CRI)	95
Colour Rendering (R9)	88
Light Field Diameter (D50)	@ 0.5m: 90mm
	@ 0.75m: 125mm
	@ 1.0m: 175mm
Light Field Diameter (D10)	@ 0.5m: 220mm
	@ 0.75m: 255mm
	@ 1.0m: 340mm
Number of LED's	6
Power Consumption	14W 0.2A
Average Working Life	>50,000 Hours
Input Voltage	100 - 240V AC 50/60 Hz
Output Voltage	30V DC 1A
Temperature Rise on Patient/User	≤2 °C
Warranty Period	5 Years
NHS E-Class Code	FBU, FKR
Commodity Code	9018 908400
GMDN Code	12276

2.1 Technical Drawing

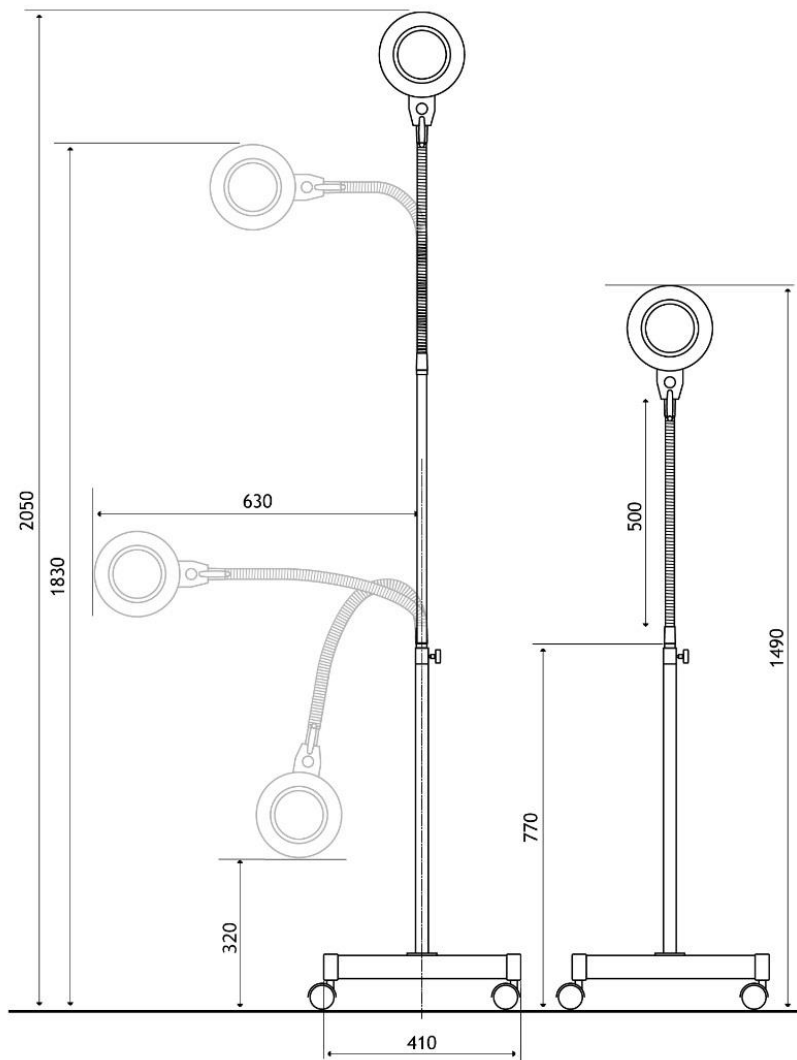

All measurements in millimetres

2.2 Pre-Installation Responsibilities and component packing list

This document is a guide to the steps that need to be performed to correctly install the X350 Examination light. However, the work required to be performed is the responsibility of the owner or designated contractor/s.

All fixings between DARAY lights and the building super-structure must be approved by either the chief project engineer or an appropriate and competent structural assessor.

The components supplied by DARAY for fitting / installation should be the following items in the specified quantities.

X350LM	Qty.
IEC Cable (5m Orange)	1
Mobile Base	1
Light head and upstand assembly	1
Bag of fixings	1
Microfibre cloth	1
User Manual & Assembly Guide	1

2.3 Pre-Start Checks



Please check that the power cable is without visible damage, harsh folds, knots or cuts in the rubberised coating.



When applicable, please check that the cable is fully inserted into the power socket, before switching the power on.



Please check that the head and all parts of the base are without visible damage.

3. Operation

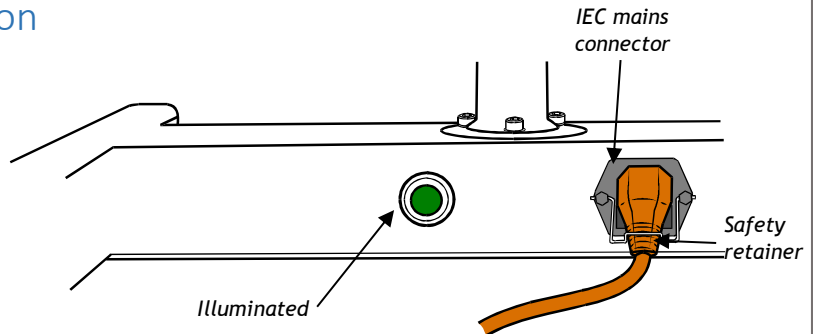

Position the light by moving it using the handle provided on the main stand.

Note: The light must not be lifted using the light-head handle or gooseneck. To position the light, hold the upstand and move the light-head using the handle.

The front castors on the base have brakes which can be used to help keep the base from moving whilst the light-head position is adjusted.

Unwrap the flex from the cable holders and plug the IEC connector into the base ensuring the metal safety retainer is fitted over the top of the IEC plug connector.

Once connected to the mains, switch the illuminated power switch ON and the green indicator will be illuminated. If the indicator does not illuminate, check the power supply and then check the fuses located in the IEC socket on the mobile base (see *section 5. FUSE REPLACEMENT*) and also in the mains plug. Further fault investigation should only be carried out by a qualified electrician.

3.1 Turning the light ON/OFF and adjusting the intensity

There is a rocker switch on the light-head near the handle. This is a momentary type switch and does not latch.

- Press the switch once to turn the light ON
- Press and hold to decrease intensity
- Press and hold to increase intensity
- Press the switch once again to turn the light OFF

Note: If mains power is removed by either unplugging or turning off at the base, the intensity will be reset to its brightest setting when the light is powered on again.

The light head can be rotated on the flexible arm which itself can be bent almost double so the light patch may be directed at will.

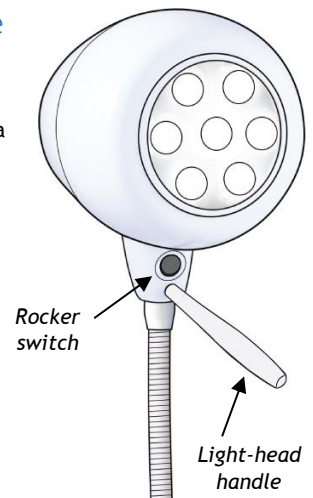

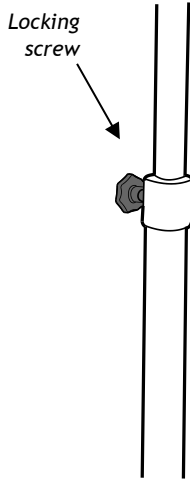

The telescopic extension is released for raising and lowering, and locked by the locking screw at the rear of the up-stand.

Use the light-head handle to position the light-patch to where it is required. In the interests of cross-infection control, avoid touching any other part of the light.

The light-handle is coated with BioProtect®.

3.2 Correct usage of the light



Caution **MUST** to be taken to ensure correct usage of the light, to preserve all features - in particular the flexible neck ('gooseneck')

If you need to bend the neck to reposition the light head, keep one hand approximately one third up the neck, and then use your other hand to curve the gooseneck through its entire range, avoiding sharp kinks that will cause irreparable damage.

Try to avoid bending the neck by pushing and pulling the light head with one hand, as it will inevitably cause undue stress on the base of the neck, and will subsequently reduce the ability of the neck to hold itself in position.

If you are intending to use the light head low to the floor - for example, in a gynaecological examination, ensure that the telescopic slide assembly is set to its lowest position.

We strongly advise that all staff members reading this manual adequately train all other staff members who may be using this light.

Common sense must prevail at all times.



This is the correct way to bend the neck, ensure you curve it through its entire range.



This is the incorrect way to bend the neck. Notice the sharp kink in the neck - this will ultimately affect future flexibility.



4. Maintenance

The proposed maintenance is only a suggestion. Depending on the use of the product and the operating environment, this may need to be revised more often.

DO NOT ATTEMPT ANY FIXES BEFORE CONSULTING DARAY.

If you cannot resolve a problem then please contact our helpline on **0800 878 9864** or email **support@daray.co.uk**

4.1 Maintenance schedule

Weekly checks should include:-	Range of movement testing, it should be light and easy to move throughout the range
	No visible signs of excessive wear.
Monthly checks to include:-	Check the joints and thumb screws for wear and report as necessary
Six monthly checks to include:-	Check all electrical connections are sound and that there is no visible cable wear.
	All fixings to be checked and be of sound construction.

4.2 Safety Precautions

- For all cleaning work, power off the equipment and where possible unplug the mains socket, only minimal cleaning fluids should be used.
- Please do not look directly into the light source when illuminated.
- If the equipment is dented or scratched this should not impact the usability of our lights however we advise that if the BioProtect® coating is damaged and the metal casing underneath is visible, please do not attempt to 'paint' over it as this will impact upon the effectiveness of the coating, simply use an alcohol based cleaning spray when cleaning and pay special attention to the cut.



If there is damage to the power cable or if exposed wire is visible
DO NOT USE

4.3 Product cleaning & care guidelines

The X350 features BioProtect® antimicrobial coating on all painted surfaces and has a fully-enclosed head with an Ingress Protection (IP) rating of 54.

These guidelines are provided to help you maintain your equipment properly and prevent any damage. Use of incompatible cleaning chemicals can adversely affect the finish and physically damage the metal and plastic parts of the DARAY product, invalidating its warranty.

Please ensure these instructions are passed to the persons responsible for cleaning and they are followed before each use.

Manufacturers recommended cleaning method:

1. Turn off the power to the light, and where possible, unplug the mains socket.
2. Remove noticeable contamination. Pay special attention to the light head and handle.
3. Ensure the equipment is surface-cleaned and disinfected using an appropriate, non-abrasive cleaning agent (see recommended list below).
4. Dry all surfaces thoroughly with a clean cloth and check for damaged surfaces, discolouration and/or contamination.

NOTE: Some DARAY products feature our BioProtect® antimicrobial coating on painted finishes. This is designed to assist with infection control and is not a replacement for cleaning.

CAUTION: Our products are NOT waterproof. The equipment and accessories (included chargers and battery packs) MUST NOT at any point be saturated, to prevent water ingress. Use a damp cloth or saturated wipe if necessary. All electrical safety guidelines should be followed.

Any damage caused as a result of not following these guidelines will void any product warranty.

Below is a partial list of recommended surface agents:

- 
- Cavicide™ products
 - Isopropyl alcohol-based cleaners (<40% alcohol)
 - Ethyl alcohol-based cleaners (<40% alcohol)
 - Lysol® disinfectant
 - Other non-bleach and non-abrasive disinfectants or cleaners

DO NOT USE agents containing the following:

- 
- Organic, mineral and oxidizing acids (min. pH value 8.5)
 - Bases (max. acceptable pH value 8.5)
 - Oxidation agents (e.g. Hydrogen Peroxide)
 - Halogens (chlorine, iodine, bromide)
 - Aromatic/halogenized hydrocarbons
 - Bleach-based cleaners (e.g. Clorox™, Sterilox™)
 - Abrasive cleaners (e.g. Comet Cleaner™)
 - Acetone-based cleaners (e.g. nail polish remover, Goo-off™)
 - MEK (Methyl Ethyl Ketone)

If you are unsure whether you are using the correct cleaning fluids on your DARAY equipment, please feel free to get in touch with us for advice.

4.4 Fuse Replacement

CAUTION: Fuses normally blow for a reason. Investigate likely faults before changing fuses.

CAUTION: Isolate the unit from the mains before accessing the fuses.

Both the live and neutral mains inputs are fused. The fuses are contained in a holder which is part of the IEC inlet mounted on the rear panel of the mobile base.

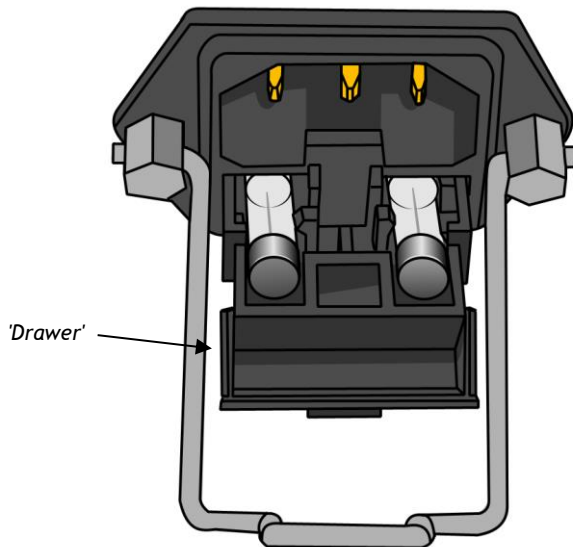

Unplug and remove IEC cable. Using a flat-bladed screwdriver, or similar, pull forward the 'drawer' containing the fuses. Hinge down the front of the holder. Lift the fuses by pushing them through the holes below.

Refit new fuses (D10873) and reverse the removal sequence, ensuring the 'drawer' is pushed fully home.



Warning: Ensure you isolate the unit from the mains power before any work related to the electrical supply.

4.5 Switch Replacement

Replacement rocker switch kit (DRK4174) contains the following items:

- D15071 - 1 x switch
- D16313 - 2 x connectors

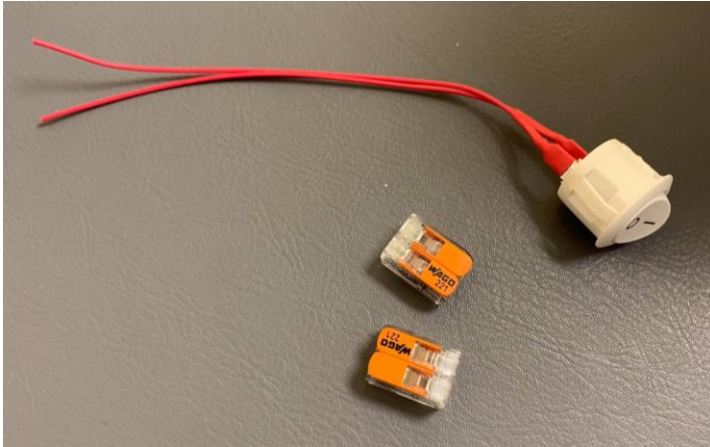

1. Remove the handle
2. Pop out the current rocker switch
3. Cut the wires to remove the current rocker switch



4. Trim the wires and attach 1 x connector to the end of each wire.
5. Trim the end of the wires on the replacement rocker switch.

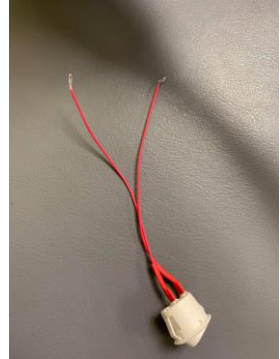

6. Insert the end of the wires on the replacement switch into the connectors.
7. Insert both connectors into the switch housing, followed by the switch, ensuring that it is secure.



5. Spare Parts

CAUTION: Use only genuine 'DARAY' replacement lamps as other types may seriously impair the optical performance of the product.

ITEM NO	PART NAME	TYPE	PART NO
1	Fuse	1A 20mm	D10873
2	Microfibre cloth	5 pack	DRK4080
3	Rocker Switch Kit	White	DRK4174
4	Replacement Handle	White	D15194
5	Replacement Power Cable	5m, Hi-Visibility	D14658
6	30V 1A LED Transformer Module	30V 1A	DRK4173

All of the above parts can be purchase via DARAY

For any SPARE PARTS or TECHNICAL ISSUES phone DARAY'S Service Delivery Team on:

+44 (0) 800 878 9864

Opening times 9am-5pm Monday to Thursday (excluding bank holidays)
9am-2:30pm on Friday

Or email:

support@daray.co.uk

**IF THE LIGHT WAS ORIGINALLY PURCHASED THROUGH A DISTRIBUTOR CONTACT THEM IN
THE FIRST INSTANCE FOR A RESOLUTION**

Please contact DARAY for help with any problems that the distributor cannot solve.



6. Warranty Information

6.1 Returns Policy

IMPORTANT!
Please fill out your warranty registration online at
www.daray.co.uk/warranty or contact Daray by phone (0800 878 9864)
or email support@daray.co.uk

DARAY's standard warranty is 12 months. However, this period may be extended to 5 years* free of charge by completing and submitting the warranty registration.

Year 1:	Warranty includes parts and labour (Return to Base)	*UK only
Year 2-5:	Parts only	

We want you to be completely satisfied with your purchase. If you need to return goods purchased from DARAY Ltd, please read the following information carefully.

The DARAY Ltd returns policy provides guidance on when you can return goods we have supplied, and what you can expect from us once you do. To see our detailed returns policy and procedure visit

www.daray.co.uk/returns

TYPE OF RETURN	REMEDY
DAMAGED GOODS Goods which are physically damaged on delivery	We must be notified within 24 hours of receipt.
Dead On Arrival (DOA) Goods which do not work	Goods which do not work on arrival or develop a fault within 28 days, we will advance replace the item.
GOODS DEVELOPING A FAULT Goods which have developed a fault within the warranty period.	If the fault develops after 28 days, but within the warranty period, we will initiate the returns procedure.
NON WARRANTY Goods which have developed a fault outside the warranty period.	If a fault develops outside the warranty period, we will initiate the returns procedure charges may be applicable.
OTHER Any situation which is not covered by any of the above.	We will always try to help, but we cannot normally offer a refund.

For additional clarification, please refer to our terms and conditions at www.daray.co.uk/terms.

In a small number of cases, we may determine that a replacement would not work any better than the original product we supplied. In such cases we will only offer a refund rather than a replacement for qualifying returns.

Replacement bulbs and spare parts ordered on our website or from supplied part codes are not eligible for credit. We will accept returns and exchange for the correct item.

If your purchase an item incorrectly you can return it within 14 days and it can be exchanged for another product of equal or higher value, excluding transportation charges incurred. Goods and packaging must be returned in their original condition. Under no circumstances will goods be accepted for return if they are damaged, have been subjected to improper handling or abuse or have been used.

If you send us goods that do not qualify for return, you will invalidate your claim to any refund, and you will be obliged to compensate DARAY Ltd for the cost of return postage and any other reasonable costs incurred processing the goods. Your statutory rights are not affected.

6.2 Warranty Details

TERMS AND CONDITIONS OF WARRANTY

1. To qualify for this warranty you must register on www.daray.co.uk or return to Daray Ltd (Daray) the duly completed warranty-registration form accompanying the product.
2. Daray warrants this product (excluding lamp) against faulty material and workmanship during the period of the warranty. The period of warranty is the period stated on your warranty card and commences on the date of purchase of the product. In the event that the product is not in good working order Daray will provide, during the warranty period, a free repair service within the United Kingdom. The warranty is subject to proof of purchase being provided; therefore, you should retain your original receipt.
 - 2.1 The repair service consists of the provision of spare parts and/or replacement products (at Daray's discretion) which will be provided on an exchange basis and will either be new, equivalent to new or reconditioned. All replaced spare parts and products shall become the property of Daray.
 - 2.2 Daray's only obligation under this warranty is the provision of the service as set out above.
 - 2.3 All products are returned to Daray at the customer's cost and risk. Products to be returned should be adequately packed. For the address to send returns to please visit www.daray.co.uk
3. Daray's arrangements for providing service provided under this warranty may include the use of sub-contractors.
4. This warranty does not cover damage or defects in the Product caused by or resulting from:
 - Wilful neglect or negligence by anyone other than Daray;
 - Improper use, storage or handling of the product;
 - Use of non-Daray approved parts (such as replacement lamps) not compatible with the Product;
 - Fire, accident or disaster;
 - Use of non-Daray modifications other than in accordance with Daray's instructions;Attachment of fittings and accessories not approved by Daray;
Repairs, modifications carried out by service personnel not approved by Daray;
 - Damage caused by chemical corrosion from cleaning agents not approved by Daray.
 - Failure to use or install the product in accordance with the manufacturer's instructions.
5. Nothing in this warranty shall have the effect of restricting or excluding the liability of Daray in respect of:
 - a) Death and personal injury caused by the negligence of Daray, or for fraud;
 - b) Under the *Consumer Protection Act 1987* to a person who has suffered damage caused by a defective product or to a dependant or relative of such a person;
 - c) Direct damage to your property caused by the proven negligence of Daray.
6. This agreement does not give any rights other than those expressly set out above and in particular, Daray will not be responsible for any loss of income, profits or contracts or any direct or indirect consequential loss, damage caused to or suffered by the purchaser as a direct result of this agreement.
7. This warranty is offered (subject to these terms and conditions) in addition to, and does not affect your statutory rights.
8. Daray may disclose your details and other personal information to companies within the Daray group including any subsidiary company or sub-contractor of Daray for the purposes of performing our obligations hereunder.
9. You must not resell outside the UK any products supplied by Daray and covered by the *Export of Goods (Control) Order 1992* (or any law that replaces it) without obtaining all necessary licences. You also agree not to sell the product in the UK if you know or think that the person buying the product intends to export it without getting the necessary licences. You agree to impose similar conditions to these on anyone you sell the product to.
10. These conditions shall in all respect be governed and construed in accordance with English law and the exclusive jurisdiction of the English courts.

Product:

Serial No:

DARAY[®]
Medical

DARAY Ltd.
Edison House
Robian Way
Swadlincote
Derbyshire
United Kingdom
DE11 9DH



+44 (0)800 878 9864



+44 (0)333 321 0973

sales@daray.co.uk • www.daray.co.uk
