

# DARAY<sup>®</sup>

## Medical



# DIAMOND

## LED Dental Examination Light Operating & Installation Manual



## Table of Contents

1. Introduction .....	3
1.1 Supported Lights .....	3
1.2 Installation Notice .....	4
1.3 Pre-Installation Responsibilities and component packing list .....	5
1.4 Technical Drawings .....	6
2. Technical Specifications .....	8
3. Operation .....	9
3.1 Pre-Start Checks .....	10
3.2 Powering On & Variable Intensity .....	10
3.2.1 Sensor Operation .....	11
3.3 Handles .....	11
4. Installation Guide Section .....	12
4.1 Ceiling Mounted Version (DIAMOND C) .....	13
4.1.1 Considerations .....	13
4.1.2 Attachment methods and void suspension .....	14
4.1.3 Lighting configuration .....	15
4.1.4 Affixing the Ceiling plate .....	15
4.1.5 Downtube adjustment and installation .....	16
4.1.6 Wiring and transformer layout .....	18
4.1.7 Arm installation .....	19
4.1.8 Fitting the lighthead .....	20
4.2 Wall Mounted Version (DIAMOND W) .....	21
4.2.1 Considerations .....	21
4.2.2 Lighting configuration .....	22
4.2.3 Attaching the Wall mount bracket .....	22
4.2.4 Arm installation .....	22
4.2.5 Wiring and transformer layout .....	23
4.2.6 Fitting the lighthead .....	24
4.3 Floor Mounted Version (DIAMOND DF M) .....	25
5. Maintenance .....	27
5.1 Maintenance schedule .....	27
5.2 Safety Precautions .....	27
5.3 Product cleaning & care guidelines .....	28
5.4 Fuses and their replacement .....	29
6. Adjustment of Arm Balance to Eliminate Drift .....	30
7. Troubleshooting Guide .....	31
7.1 Safety Precautions .....	32
8. Spare Parts .....	32
9. Warranty Information .....	33
9.1 Returns Policy .....	33
9.2 Warranty Details .....	34

## 1. Introduction

Thank you for choosing a Daray DIAMOND dental light.

The DIAMOND Series of lights are specifically designed to meet the demanding needs of today's dental industry whilst providing the finest quality design with superior performance, reliability and value. The DIAMOND is mounted on Daray's characteristic balanced suspension arm system. It features a motion controlled sensor on the underside of the lighthouse which can be used to power the unit on and off. This sensor can also be used to control the variable intensity of the light, reducing the need to touch any surfaces.

This user & installation guide contains all the information you need for installation, operation and maintenance.

For further information on our product range and find out more about our company please visit [www.daray.co.uk](http://www.daray.co.uk) or call 0333 321 0971 or 0800 804 8384.

This product was designed & manufactured in Great Britain by:

Daray Ltd.  
Edison House  
Robian Way  
Swadlincote  
Derbyshire  
DE11 9DH

### 1.1 Supported Lights

The Following Models are supported in this Manual	
DIAMOND C	DIAMOND LED Dental Examination Light - Ceiling Mounted
DIAMOND CS	DIAMOND LED Dental Examination Light - Ceiling Mounted (short reach)
DIAMOND W	DIAMOND LED Dental Examination Light - Wall Mounted
DIAMOND WS	DIAMOND LED Dental Examination Light - Wall Mounted (short reach)
DIAMOND U	DIAMOND LED Dental Examination Light - Unit Mounted
DIAMOND DF M	DIAMOND LED Dental Examination Light - Floor Mounted

## 1.2 Installation Notice

With over 50 years of experience, DARAY take pride in offering consultancy and providing guidance on the installation and use of our lighting range.

Should you ever require any advice with the installation or operation of one of our devices, please contact our Service Delivery Helpline on **0800 878 9864** or online at [support@daray.co.uk](mailto:support@daray.co.uk) We have a team of dedicated technical engineers and service representatives who are capable of providing guidance or bespoke solutions for most situations.

DARAY offer installation services with our equipment. If you choose to opt out of our installation service, DARAY cannot be held responsible for the installation of the product detailed in your order. Should the product be incorrectly installed, violate health & safety, or cause injury to a third party, the responsibility is with the installer. As such we feel it necessary to provide the following general guidance.

- The location of each light should be given careful consideration; based upon the intended area, the lights reach, which part of the body the light is being used for and the preferences of the end user.
- Confirm the structural suitability of the installation area **before** commencing any work. If there is any doubt it may be necessary to involve structural engineers to verify suitability of the area.
- Commissioning of our light fittings should always be carried out in collaboration with the end users,
- Commissioning should include basic training in the operation of the unit before it is used
  - This ensures that the units are correct for the user, installed in the correct location for the intended usage, and that sufficient provision has been made to avoid mishandling of the unit.

Every effort is made to provide the most accurate and up to date instructions in the easiest manner but if you require more help we would like to encourage you to contact us, as any deviation or failure to adhere to our installation procedures can result in:

- limited movement of the light
- Improper functionality
- Lasting damage to the product
- Damage to the install location
- Health & Safety non-compliance
- And in extreme circumstances could cause physical injury

If you are unsure of ANYTHING, please contact us before any attempt at installation is made. Customer safety is essential to us and it is our job to ensure optimum product performance in line with their design.

If you have any questions relating to our products, or if you are seeking guidance in line with what is recommended above, please call our Service Delivery Helpline on **0800 878 9864**, or ask one of our dedicated Sales team.

### 1.3 Pre-Installation Responsibilities and component packing list

This document is a guide to the steps that need to be performed to correctly install the DIAMOND dental light unit. However, the work required to be performed is the responsibility of the owner or designated contractor/s.

All fixings between Daray lights and the building super-structure must be approved by either the chief project engineer or an appropriate and competent structural assessor.

The components supplied by Daray for fitting / installation should be the following items in the specified quantities.

DIAMONDC / DIAMONDCS	Qty.	DIAMONDW / DIAMONDWS	Qty.
Ceiling Mount Plate	1	Wall Mount Bracket	1
1m (2m optional) Downtube	1	Rotation and suspension arm system	1
Rotation and suspension arm system	1	Lighthouse	1
Suspended Ceiling Cover	1	Wall mounted power supply	1
Lighthouse	1	Microfibre cloth	1
Ceiling Mount Cover (Optional)	1	User Manual	1
Microfibre cloth	1		
User Manual	1		

DIAMONDDFM	Qty.	DIAMONDU	Qty.
Footplate	1	Floor mount upstand	1
Upstand (6ft)	1	Rotation and suspension arm system	1
Rotation and suspension arm system	1	Lighthouse	1
Lighthouse	1	Toroidal Transformer / PSU	1
Toroidal Transformer / PSU	1	Microfibre cloth	1
Microfibre cloth	1	User Manual	1
User Manual	1		

To use the ceiling mounted edition of this light for fixing points over 2.9m, you will require Daray's 2m downtube or a customised length.

## 1.4 Technical Drawings

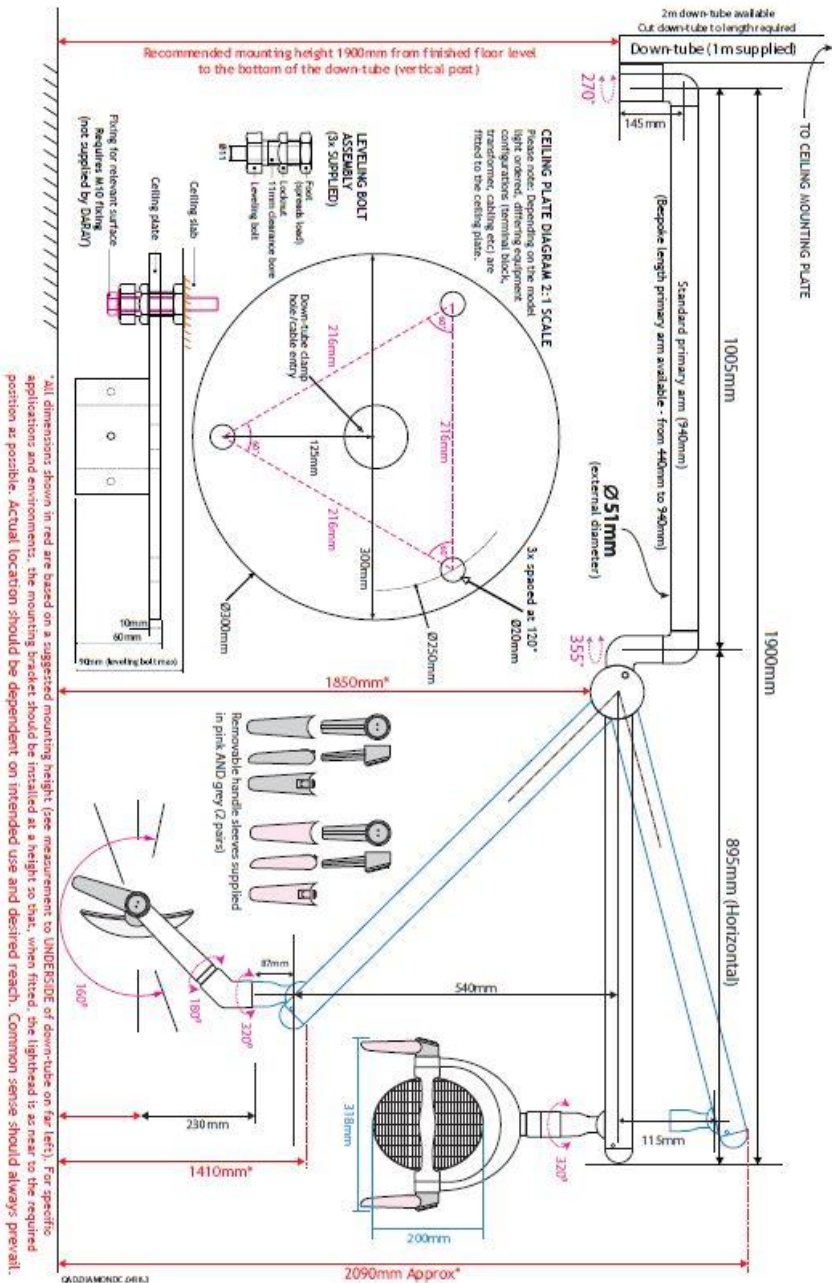





## 2. Technical Specifications

<b>Light Source</b>	LED
<b>Light Intensity (Lux) @ 0.7m</b>	7,500 - 35,000 Lux $\pm$ 5%
<b>Light Intensity Adjustment Range</b>	5% - 100%
<b>Colour Temperature (Kelvin)</b>	5,000K $\pm$ 5%
<b>Colour Rendering Index (Ra)</b>	85
<b>Light Field Diameter</b>	150mm x 70mm ( $\pm$ 20mm)
<b>Power Consumption</b>	8-12W $\pm$ 2%
<b>Average Working Life</b>	>50,000 hours
<b>Input Voltage</b>	100 - 240V AC 50/60Hz
<b>Output Voltage</b>	12V AC $\pm$ 2%
<b>Temperature Rise on Patient/User</b>	$\leq$ 2 °C
<b>Head Rotation</b>	160° - 320°
<b>Body Colour</b>	RAL 9001 (White)
<b>Arm Reach</b>	1650 - 1900mm
<b>Warranty Period</b>	3 Years
<b>NHS E-Class Code</b>	FBU, FKR
<b>Commodity Code</b>	9018 908400
<b>GMDN Code</b>	12276

### 3. Operation

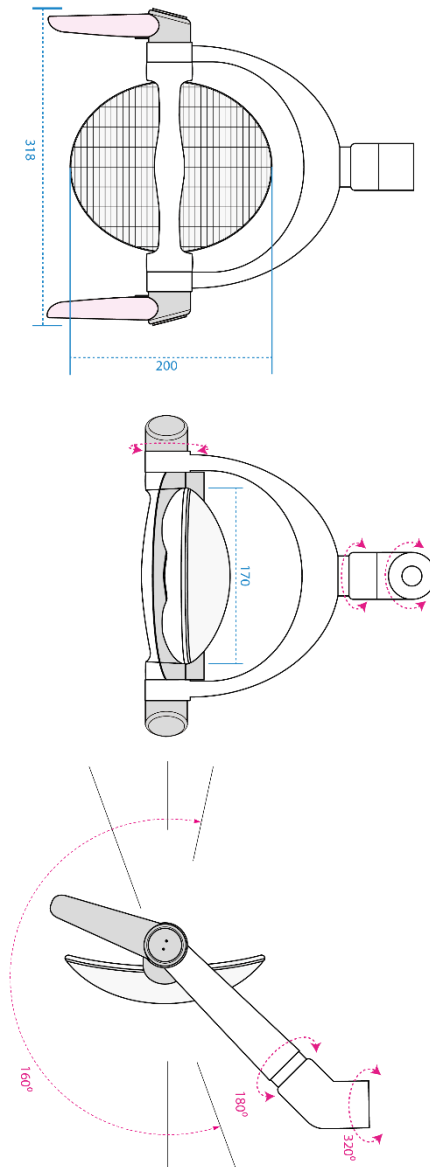

### 3.1 Pre-Start Checks



Please check (when applicable) that the head and arms are without visible damage, and all LED's are present and working in the head.



Please note, the light may take a few seconds to power on fully and illuminate, please be patient when first turning on the light.



Users should not look directly into the light as it is bright and will illuminate when powering on.

### 3.2 Powering On & Variable Intensity

The DIAMOND has two switch systems that can be used to power the light on or off. The first is a physical switch located on the underside of the lighthead spigot. The other is an infrared relay located on the right side handle.

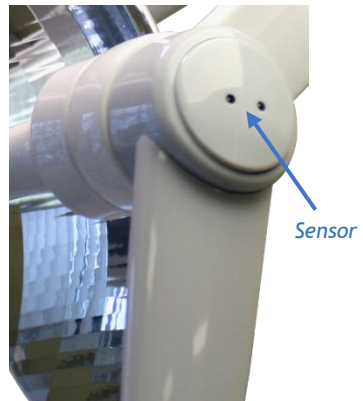
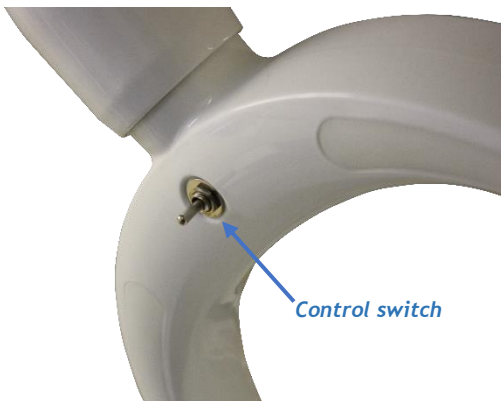

These controls can also be used to alter the lights variable intensity; push and hold the switch, or hold your hand in front of the sensor, to change the light intensity up or down.

There is an audible beep from the unit when the light reaches on of its variable intensity peaks (highest and lowest).

**Please Note, The variable intensity control has a memory function; whereby, if the light is turned off at a dimmed level, it will remember that level the next time it is turned on.**

### 3.2.1 Sensor Operation

You can operate the light by passing your hand in front of the sensor. The **infrared proximity switch is located on the right side handle**. The control range for this is **approximately 100mm**.

- Pass hand in front of the sensor (either direction) once to turn the light ON or OFF
- Place hand in front of the sensor and hold to increase or decrease intensity

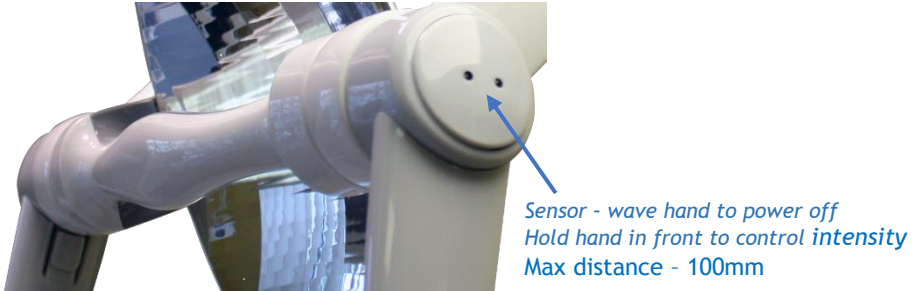

After use, turn off at the lighthead with the sensor or switch. Where applicable, also turn off the light at the power-supply via the wall mounted module or switched fused spur.

### 3.3 Handles

The DIAMOND series light has detachable handles that can be attached to the lighthead.

**Note: The handles are removable for cleaning but are NOT suitable for autoclaving**

To remove the handle, hold it in one hand and press the lock button on the handle to release the locking mechanism. Pull the handle away from the head carefully.

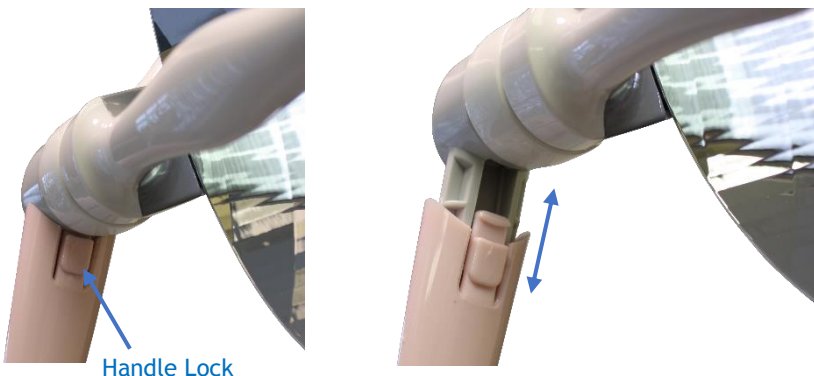

## 4. Installation Guide Section

## 4.1 Ceiling Mounted Version (DIAMOND)



### 4.1.1 Considerations



The procedures below are detailed to a high level however ***If in doubt please consult a qualified electrician.***

Minimum Room Requirements	<p>The ceiling mounted version of the DIAMOND has a recommended install height where the bottom of the wall bracket is approximately 1900mm from the floor.</p> <p>When cutting the downtube to the required height you will need to account for the ceiling plate clamp and leave a gap between the plate and the ceiling for the cable flow.</p>
Maximum Room Requirements	<p>The maximum fixing height available with a 1m downtube is approximately 2900mm from the floor. For ceiling heights above this a 2m downtube may be required.</p> <p>For lights being installed into suspended ceiling area's a uni-strut platform can be used to bring the fixing point down.</p>
Live Electric Circuitry	All personnel working around live circuitry should be qualified and following proper procedures
Heavy or Difficult fittings	Fitting the ceiling plate can be difficult and aspects of the fitting may require more than one person; this work should only be attempted by appropriate and competent personnel.
Existing Environmental Factors	When fitting, considerations have to be taken for existing services such as; fire alarms, vents, lights, etc. along with interior ceiling construction and any surrounding hazard.
Environmental Responsibility	Once our products are installed all packaging should be disposed of appropriately and recycled where appropriate and in accordance with local governing regulations.

These instructions are based on the assumption of a fresh fit into a room with no previous lighting structures. With installations onto sites with equipment already in place, we recommend that the previous lights' mounting plate be removed and the new one fitted as if into a fresh fitting.

After concluding the structural stability of the ceiling structure it will be necessary to assess the construct and decide on the best course of action for installing the ceiling plate. There are various different methods for fixing the plate onto the ceiling, below are a few example methods that can be used.

#### 4.1.2 Attachment methods and void suspension

Please note, the minimum room height allowed for fixing requires the bottom of the ceiling plate to be no lower than 2290mm.

- **Bolted Directly into the structure and secured with chemical bonding**

This is our primary choice for mounting our lights to the ceiling structure, appropriate rawl bolts and chemical bonding should be used to secure the fitting.

- **Bolted to a Uni-strut Construct**

When using a uni-strut construct for mounting the ceiling plate, you should ensure that the uni-strut is cross braced to ensure it is secure and does not move.

- **Weight dispersed over several timber frames**

Timber framing can be used for attaching ceiling mounted units. The framing should be assessed by a competent structural engineer to ensure suitability; appropriate fixings should also be used.

Another option available would be attaching the ceiling plate to uni-strut that has been used to sandwich multiple timber rafters there-by spreading the weight of the unit across an enlarged area.

### 4.1.3 Lighting configuration

Dependant on the choice of attachment method, and whether the light is being attached in a void or directly onto an open surface ceiling; custom mounting aspects may be required.

Daray's standard mounting recommendation is to have the ceiling plate fixed directly into the ceiling structure whenever possible. This would also be suitable for open surface, non-voided areas with the use of an optional ceiling mount cover.

Ultimately the mounting method used is the responsibility of the project engineer or fitter. This includes the specification of attachment hardware, lateral bracing and the suitability of the surface to be fixed to.

### 4.1.4 Affixing the Ceiling plate

The location of the light should be decided by the end user / project manager or through schematical drawings.

Once the location has been decided it will be necessary to first mark the location of the fixing points. This can be done by placing the ceiling plate in position and using the holes in the plate as a template, mark the locations of the fixing points on the fixing structure.

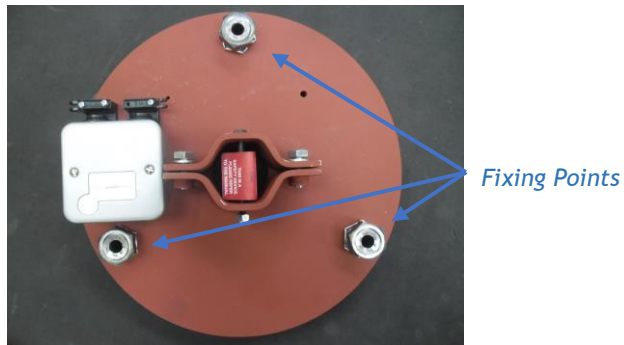

\* Picture for illustration purposes only.

Remove the plate, now drill holes relevant to the structure and fixing bolts used. Please use appropriate fixings when securing the plate to the ceiling.

Once the plate has been fitted, it will be necessary to ensure that it is balanced on the horizontal plane. This can be achieved by adjusting the three large bolts. After any adjustment it will be necessary to check that all fixings are still sound and that locking nuts are tight.



### 4.1.5 Downtube adjustment and installation

The downtube provided will be either 1m as standard or 2m (optional) maximum with a boot on the bottom. It is Daray's recommendation that the bottom of the downtube is approximately 1900mm from the floor once installed.

Measure the distance from the ceiling plate to where the bottom of the downtube will sit. Mark and cut the downtube. When cutting the downtube to length it is highly recommended that you push the wire back inside the downtube so that you don't cut through it. The downtube should be cut to length on site to suit the particular ceiling height and application.



Once the downtube has been cut to length it will be necessary to de-burr the end of the tube, as this can help prevent damage to the cable.



Note, when installed the downtube must leave clearance above the ceiling mount plate to prevent the cable being trapped.

Loosen the clamp on the top of the ceiling plate and remove the safety bolt. Insert the downtube and adjust the boot of the downtube to be facing the examination area.

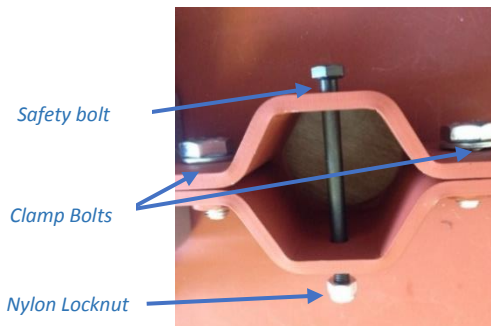

**Note:** For suspended ceilings, there is a small suspended ceiling trim and rubber retaining band included. For units being installed into an open ceiling there is a full size ceiling mount cover available as an optional extra from Daray.

**NOTE:** For suspended ceilings cut a clearance hole in a ceiling tile and slide this over the top of the downtube and suspended ceiling trim before attaching to downtube to the ceiling plate.

Now you should put the rubber retainer ring onto the downtube followed by either the ceiling trim or ceiling mount cover. This is to allow the covers to be fixed into position after you have attached the downtube to the ceiling plate.



Thread the wire back up through the downtube and feed it up through the middle of the ceiling plate; then place the downtube loosely between the clamps on the ceiling plate.

Next you will need to drill the safety bolt hole. Before drilling, please direct the boot on the bottom the downtube toward the centre of the examination area to allow the best range of motion over the examination area.

With the downtube directed, use the two holes in the metal clamps to mark the location where the safety bolt will go through. Remove the downtube and secure for drilling. A 6mm hole should be drilled through the downtube on both sides to allow the bolt to pass through.

Re-insert the downtube into the ceiling plate, insert the safety bolt through the clamps and the downtube (being careful not to catch the wire). Then tighten the clamps and the safety bolt / nylon locknut.



**NOTE: TO ENSURE THE USER'S SAFETY, THE SAFETY BOLT AND NYLON INSERT LOCK NUT MUST BE FITTED PROPERLY**

It will be necessary to ensure that the downtube is absolutely vertical to prevent arm drift. This can be achieved by adjusting the three securing points on the plate, once adjusted, use the locking nut secure the adjustments. After any adjustment it will be necessary to check that all fixings are still sound and that locking nuts are tight.

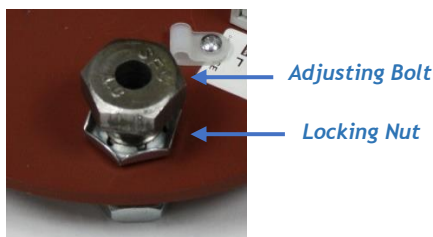

#### 4.1.6 Wiring and transformer layout



**Before working on electrical connections please make sure that the power to the light is switched off at the source and secured so that it will not be turned on during your work.**

Ideally the cable used to power the light should be of a 1.5mm twin and earth type. Daray recommends that the power supplied uses an earthed switched fused spur, protected with a 3amp fuse.

The wiring should be as follows:	
Live terminal	→ <b>brown wire.</b>
Neutral terminal	→ <b>blue wire.</b>
Earth terminal	→ <b>green/yellow wire.</b>

The above wiring is for modern wiring applications (post 2000). The cable from the downtube will have a Molex connection on the end. This will attach to the opposite Molex connection from the transformer.

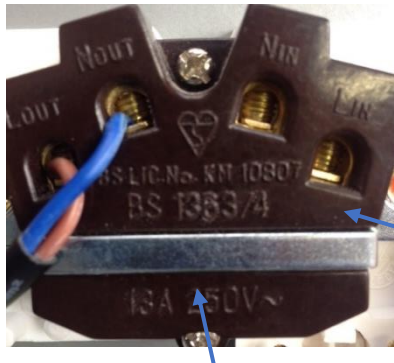

*Mains Power  
should be  
inserted here*

*Fuse Holder around the front  
- 3 Amp Fuse - D15998*

To connect the cabling from the transformer into the main power you will need to run this connection into the switched fused terminal point above. With the connection secured you can now move the relevant cover up the downtube.

**NOTE: For suspended ceilings,** slide the previously cut tile back into place first, then slide the trim up the downtube until it is firmly against ceiling tile, then roll the trim retaining band upward until it holds the trim in position

**NOTE: For conventional ceilings** fit the cover, holding it in place with the retaining band from the fitting kit.

### 4.1.7 Arm installation

To ensure the smooth rotation of the arm, it is essential that the primary arm spigot is **lightly** lubricated before being inserted into the boot of the downtube.

Place the white nylon washer over the primary arm spigot. Using the sachet of silicon grease provided, lubricate the indicated sections of the arm spigot.

Whilst inserting the arm spigot into the downtube boot, feed the cable connection through the bottom of the boot.

Join the connector from the arm system to the connector from the downtube.

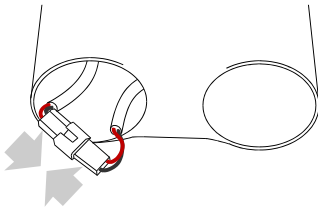
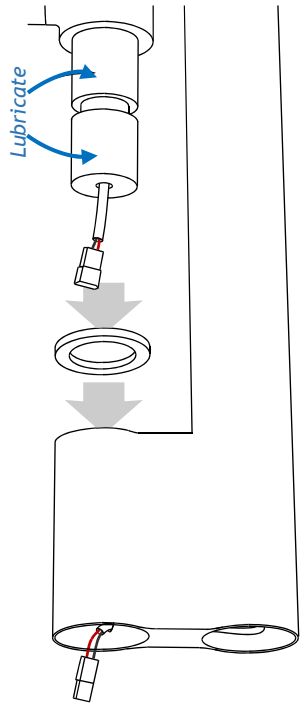

Then sit the connection inside one of the supplied bungs and insert the bung into the bottom of the downtube.

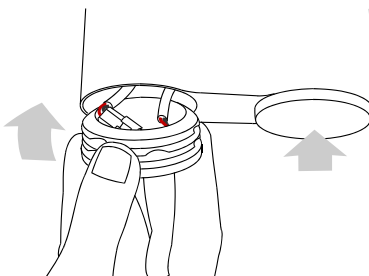

#### 4.1.8 Fitting the lighthead

Connect the lighthead connector to the connector from the arm; apply a small amount of grease to the light-head spigot and insert it into the arm, being careful not to trap the cable/connector.

Whilst supporting the lighthead in one hand, insert and tighten the locking grub-screw with the hex key provided.



**Please Note: The grub screw should be as tight as possible.**

Check everything for tightness and safety, then the arm and head for smooth and correct freedom of movement; rebalance the suspension arm if necessary.

Once checked and fully earthed, the light can now be tested by applying power. Press the power button on the back of the head or use the hand sensor located on the front of the lighthead under the fascia.

Check the variable intensity by either holding your hand in front of the sensor or by pressing and holding the rocker switch. Your new Daray light is now ready for use.

*See section 3: Operation*



To gain full support of our warranty please fill in our warranty web form or contact Daray by phone or email.

## 4.2 Wall Mounted Version (DIAMONDW)



### 4.2.1 Considerations

<p>Wall Construction</p>	<p>Before fixing it is important to consider the strength of the wall and the depth of the fixings used.</p> <p>Use of a building engineer or structural drawings may be required to decide on suitability.</p>
<p>Examinations to be undertaken</p>	<p>The Wall mounted version of the DIAMOND has a recommended install height where the bottom of the wall bracket is approximately 1900mm from the floor.</p> <p><b>It may be necessary to adjust this height, if there are specific medical procedures the light will be used for.</b> If in doubt consult the end user or DARAY. When installing the bracket take consideration of where you want the lighthouse to sit when in its lowest position.</p>
<p>Heavy or Difficult fittings</p>	<p>Fitting the mounting plate can be difficult and aspects of the fitting may require more than one person; this work should only be attempted by appropriate and competent personnel.</p>
<p>Existing Environmental Factors</p>	<p>When fitting, considerations have to be taken for existing services such as; cabinets, vents, light switches, etc. along with interior wall construction and any surrounding hazard.</p>
<p>Environmental Responsibility</p>	<p>Once our products are installed all packaging should be disposed of and recycled appropriately and in accordance with local governing regulations.</p>

### 4.2.2 Lighting configuration

Dependant on the choice of attachment method custom mounting aspects may be required. Daray's standard mounting recommendation is to have the wall plate fixed directly onto a clear/open surface, weight supporting wall structure.

Ultimately the mounting method used is the responsibility of the project engineer or fitter. This includes the specification of attachment fixings, hardware, lateral bracing and the suitability of the surface to be fixed to.

### 4.2.3 Attaching the Wall mount bracket



**The wall bracket needs to be aligned & true on the vertical plane.**

Determine where to mount the wall bracket. Align the bracket to the wall and mark your fixing points. Ensure the bracket is completely true on both the horizontal and vertical planes as otherwise it may cause the arms to swing uncontrolled.

Fix the bracket to the wall, ensuring it is truly vertical and using appropriate fixings.

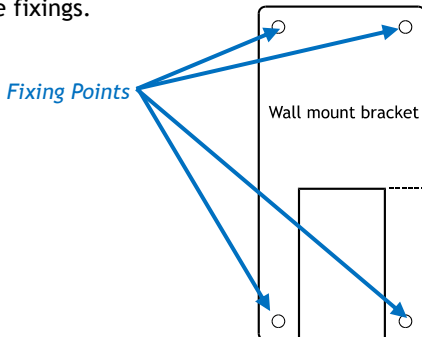

### 4.2.4 Arm installation

To ensure the smooth rotation of the arm, it is essential that the primary arm spigot is **lightly** lubricated before being inserted into the wall mount bracket.

Place the white nylon washer over the primary arm spigot. Then using the sachet of silicon grease provided, lubricate the indicated sections of the arm spigot.

Whilst inserting the arm spigot into the wall mount bracket, feed the cable connection through the bottom.

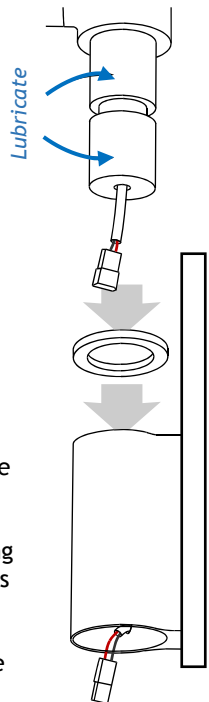

Next you will need to attach the Power Supply Unit (PSU) to the wall directly under the wall mount bracket. The wall mounted PSU is attached via four fixing points located on the inside of the casing.

#### 4.2.5 Wiring and transformer layout

Remove the fascia of the PSU by removing the two screws in the front to gain access to the fixing points on the inside.

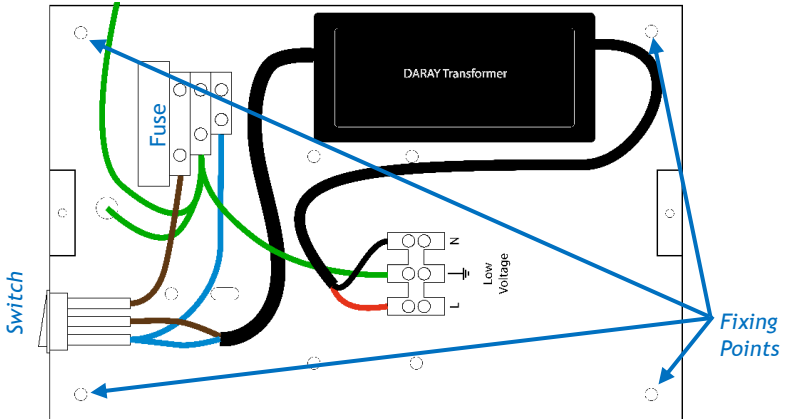

\* Different models have varying transformers. Picture for illustration purposes only.

**Note:** End user requirement may need you to rotate the PSU 90 degrees left or right depending on where the user wants the power switch to be located

Align the rear half of the PSU to be true on the wall then mark the locations for the fixings. Remove the PSU, drill holes for the fixing points and then move the PSU back into position and insert appropriate fixings.

Feed the cable from the bottom of the light down through the bottom of its wall mount bracket and feed the cable into the PSU through one of the grommet knock-outs. Connect the light and the isolated mains to the correct locations within the PSU.



**WARNING:** this light operates from a low-voltage supply produced by a transformer in the PSU, fed through the suspension arm. On NO ACCOUNT should this unit be connected directly to mains electricity.

Connect the low-voltage cable to the 3-way 'LEN' terminal block wired to the low-voltage output from the transformer. The power-supply module requires an earthed 230V AC electrical supply fed into it via a switched fused spur.

Fasten the module's earth-bond wire to the fascia plate's earth stud and re-attach the plate of the PSU using the two screws previously removed.



#### 4.2.6 Fitting the lighthead

Connect the lighthead connector to the connector from the arm; apply a small amount of grease to the light-head spigot and insert it into the arm, being careful not to trap the cable/connector.

Whilst supporting the lighthead in one hand, insert and tighten the locking grub-screw with the hex key provided.



**Please Note: The grub screw should be as tight as possible.**

Check everything for tightness and safety, then the arm and head for smooth and correct freedom of movement; rebalance the suspension arm if necessary.

Once checked and fully earthed, the light can now be tested by applying power. Press the power button on the back of the head or use the hand sensor located on the front of the lighthead under the fascia.

Check the variable intensity by either holding your hand in front of the sensor or by pressing and holding the rocker switch. Your new Daray light is now ready for use.

*See section 3: Operation*



To gain full support of our warranty please fill in our warranty web form or contact Daray by phone or email.

### 4.3 Floor Mounted Version (DIAMONDDFM)

List of components:

- Dental footplate
- Upstand (6ft)
- Dual arm system (primary arm and spring-balanced)
- Wiring
- DIAMOND head
- 8nr grub screws
- Toroidal Transformer

Determine that you have all of the parts as per the above packing list. The upstand comes as a standard length of 6ft.

1. Assume a suitable fixing position for the footplate and fix the footplate to the floor. We recommend the foot is orientated towards the chair. (*Fig. 1*)

**NOTE: It is the responsibility of the installer to ensure correct and adequate fixings. If you are unsure you should seek professional advice from someone with a structural knowledge.**

2. Insert the upstand into the floor mount (*Fig. 2 & 3*). Turn the upstand so that the protruding cable is pointed towards the chair.
3. The upstand can then be tightened into the footplate using the 8nr grub screws on the sides of the collar (*Fig. 4*).
4. Slight vertical adjustments can be achieved by adjusting the grub screws in/out to push the upright to ensure the upstand is on a true vertical plane. If an uneven floor means that there is not enough tolerance to achieve vertical plumb, then it may be necessary to pack the footplate.
5. The spigot on the primary arm should be lightly greased and offered to the top of the upstand. Make the electrical connection and fit the arm system into the top of the upstand (*Fig. 5*).
6. Lightly grease the spigot of the dental head and offer to the end of the spring arm, following the instructions for fitting the lighthouse on the previous page (*Section 4.2.6*).
7. Ensure correct movement through all motion of the arm.
8. Fit the wire from the bottom of the upstand to the transformer. If possible, locate the transformer underneath the chair / spittoon.
9. Wire the transformer into supply, apply power to the transformer and test the light.

*Continued overleaf*

The spring-balanced arm within the dual arm system within the factory. However, if the springs have settled during transit, you may need to adjust the tension. (See page 30; Section 6)

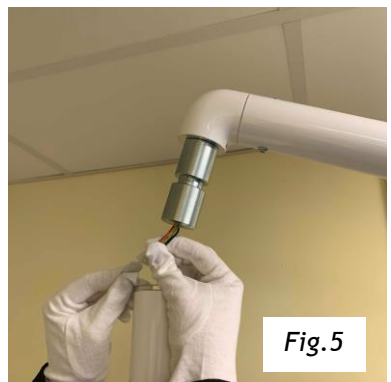
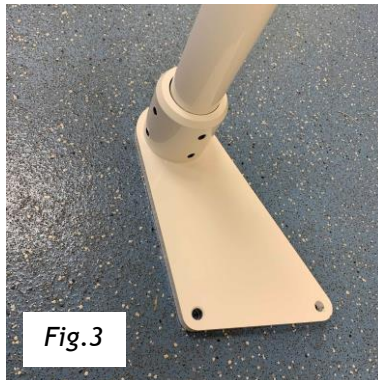
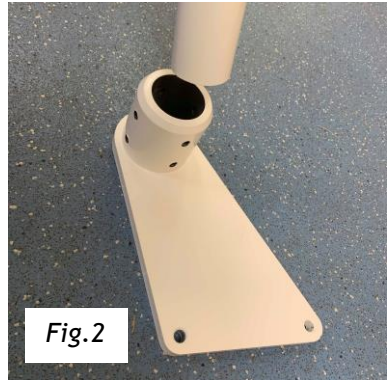
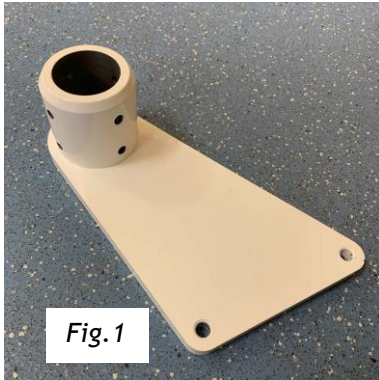

## 5. Maintenance

The proposed maintenance is only a suggestion. Depending on the use of the product and the operating environment, this may need to be revised more often. Daray would strongly recommend against “quick fixes” with tape, etc. If you cannot resolve a problem then please contact our helpline on **0800 878 9864** or email **support@daray.co.uk**

### 5.1 Maintenance schedule

<b>Weekly checks should include:-</b>	Range of movement testing, it should be light and easy to move throughout the range
	No visible signs of excessive wear.
<b>Monthly checks to include:-</b>	Check the downtube and joints for wear and report as necessary
<b>Six monthly checks to include:-</b>	Remove head and clean the interior of the hinge
	Remove arm, clean spigot and re-grease as necessary.
	Check all electrical connections are sound and that there is no visible cable wear.
	All fixings to be checked and be of sound construction.

### 5.2 Safety Precautions

- For all cleaning work, power off the equipment and where possible unplug the mains socket, only minimal cleaning fluids should be used.
- Please do not look directly into the light source when illuminated.
- If the equipment is dented or scratched this should not impact the usability of our lights however we advise that if the BioProtect® coating is damaged and the metal casing underneath is visible, please do not attempt to ‘paint’ over it as this will impact upon the effectiveness of the coating, simply use an alcohol based cleaning spray when cleaning and pay special attention to the cut.



If there is damage to the power cable or if exposed wire is visible  
**DO NOT USE**

### 5.3 Product cleaning & care guidelines

The DIAMOND features BioProtect® antimicrobial coating on all painted surfaces and has a fully-enclosed head with an Ingress Protection (IP) rating of 54.

These guidelines are provided to help you maintain your equipment properly and prevent any damage. Use of incompatible cleaning chemicals can adversely affect the finish and physically damage the metal and plastic parts of the DARAY product, invalidating its warranty.

Please ensure these instructions are passed to the persons responsible for cleaning and they are followed before each use.

#### Manufacturers recommended cleaning method:

1. Turn off the power to the light, and where possible, unplug the mains socket.
2. Remove noticeable contamination. Pay special attention to the light head and handle.
3. Ensure the equipment is surface-cleaned and disinfected using an appropriate, non-abrasive cleaning agent (see recommended list below).
4. Dry all surfaces thoroughly with a clean cloth and check for damaged surfaces, discolouration and/or contamination.

**NOTE:** Some DARAY products feature our BioProtect® antimicrobial coating on painted finishes. This is designed to assist with infection control and is not a replacement for cleaning.

**CAUTION:** Our products are NOT waterproof. The equipment and accessories (included chargers and battery packs) MUST NOT at any point be saturated, to prevent water ingress. Use a damp cloth or saturated wipe if necessary. All electrical safety guidelines should be followed.

Any damage caused as a result of not following these guidelines will void any product warranty.

#### Below is a partial list of recommended surface agents:

- 
- Cavicide™ products
  - Isopropyl alcohol-based cleaners (<40% alcohol)
  - Ethyl alcohol-based cleaners (<40% alcohol)
  - Lysol® disinfectant
  - Other non-bleach and non-abrasive disinfectants or cleaners

#### DO NOT USE agents containing the following:

- 
- Organic, mineral and oxidizing acids (min. pH value 8.5)
  - Bases (max. acceptable pH value 8.5)
  - Oxidation agents (e.g. Hydrogen Peroxide)
  - Halogens (chlorine, iodine, bromide)
  - Aromatic/halogenized hydrocarbons
  - Bleach-based cleaners (e.g. Clorox™, Sterilox™)
  - Abrasive cleaners (e.g. Comet Cleaner™)
  - Acetone-based cleaners (e.g. nail polish remover, Goo-off™)
  - MEK (Methyl Ethyl Ketone)

If you are unsure whether you are using the correct cleaning fluids on your DARAY equipment, please feel free to get in touch with us for advice

## 5.4 Fuses and their replacement



**Warning: Ensure you isolate the unit from the mains power before any work related to the electrical supply.**

For the ceiling mounted light, the fuse is located on the ceiling plate within the terminal block connector. The fuse tray can easily be removed and the fuse replaced. The fuse supplied is a 3amp fuse (D14901).

The fuse for the wall mounted light is located within the wall mounted power supply module.

## 6. Adjustment of Arm Balance to Eliminate Drift

The jib arm on your DARAY light will have been balanced during manufacture, however over time you may need to occasionally rebalance the arm, particularly if the arm 'drifts' into a lower position when you move the head.

**Note:** Before adjusting the arm tension, ensure the head and handle are both attached.

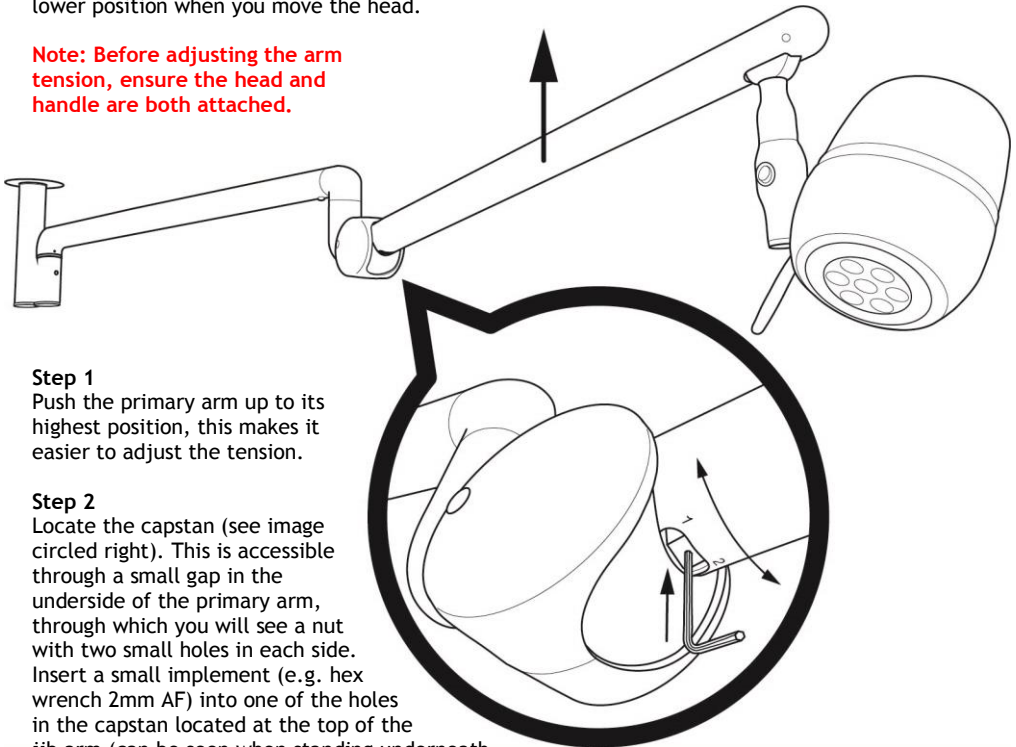

### Step 1

Push the primary arm up to its highest position, this makes it easier to adjust the tension.

### Step 2

Locate the capstan (see image circled right). This is accessible through a small gap in the underside of the primary arm, through which you will see a nut with two small holes in each side. Insert a small implement (e.g. hex wrench 2mm AF) into one of the holes in the capstan located at the top of the jib arm (can be seen when standing underneath the arm). You will see stickers labelled 1 and 2 on either side of the capstan opening.

### Step 3

**TIP:** Grip the hex wrench as close as you can to the base to prevent it from bending.

- If the arm is drifting downwards: Turn the capstan in the direction of label 2 until desired balance is obtained.
- If the arm is drifting upwards: Turn the capstan in the direction of label 1 until desired balance is obtained.

You should be able to set the head in the required position with no further movement once you let go of the head.

To assist in making this adjustment, it may be necessary to remove the arm joint cover (see section 6.4 - page 23). This provides better access to the slot through which the capstan nut is adjusted.

**Note:** When re-assembling the arm joint cover, ensure that the moving cover is correctly positioned with the 'T' notation on the component at the 'Top'.

## 7. Troubleshooting Guide

Problem	Possible Cause	Corrective Actions
<b>No light output</b>	Power Supply	Check the power to the light is switched on at the fused spur and the connection between the light and the PSU are full and secure. If they are, check the output of the transformer with a voltmeter.
	On/Off/Intensity Button	Press the switch on the back of the lighthead to check if the light will power on (if dimmed attempt to change intensity, if intensity doesn't alter, please refer to poor light output actions).
	Fuses	Visually check fuses then check continuity with a meter
	Cables	Check the visible wiring and make sure the connections between the light and the downtube / PSU are fully connected.
<b>Poor Light output</b>	Power Button	Please check the variable intensity is not just set to its minimum. To do this hold in the power switch on the back of the head or use the infrared sensor. These are the controls used to adjust the intensity. If the light reduces more, simply remove your hand and then repeat the process.
	Voltage in	Verify that the correct mains voltage and correct transformer is being used
	Voltage out	Verify correct secondary voltage, nominal when under load.
<b>Light patch not focused</b>	Light head	In the unlikely event that this happens, please contact Daray
<b>Arm drift sideways</b>	Wall mount or downtube	On installation the arm may not have been vertically aligned and levelled. Please check the alignment and contact the original fitter if not level
<b>Vertical drift</b>	Spring-balanced arm	This can be resolved following the instructions in section 6 of this user manual, if these instructions do not resolve the issue, please contact Daray



## 7.1 Safety Precautions

- For all cleaning work, power off the equipment and where possible unplug the mains socket, only minimal cleaning fluids should be used.
- Please do not look directly into the light source when illuminated.
- If the equipment is dented or scratched this should not impact the usability of our lights however we advise that if the BioProtect® coating is damaged and the metal casing underneath is visible, please do not attempt to ‘paint’ over it as this will impact upon the effectiveness of the coating, simply use an alcohol based cleaning spray when cleaning and pay special attention to the cut.



If there is damage to the power cable or if exposed wire is visible  
**DO NOT USE**

## 8. Spare Parts

**CAUTION:** Use only genuine ‘DARAY’ replacement lamps as other types may seriously impair the optical performance of the product.

ITEM NO	PART NAME	TYPE	PART NO
1	Fuse	3A 25mm	D14901
2	Microfibre cloth	5 pack	DRK4080
3	Replacement Handle	Grey	CS6199
4	Replacement Handle	Pink	CS6200
5	Toroidal Transformer	12V AC	DRK4136

All of the above parts can be purchased via DARAY

For any SPARE PARTS or TECHNICAL ISSUES phone DARAY’S Service Delivery Team on:

**+44 (0) 800 878 9864**

Opening times 9am-5pm Monday to Thursday (excluding bank holidays)  
9am-2:30pm on Friday

Or email:

**support@daray.co.uk**

**IF THE LIGHT WAS ORIGINALLY PURCHASED THROUGH A DISTRIBUTOR CONTACT THEM IN THE FIRST INSTANCE FOR A RESOLUTION**

Please contact DARAY for help with any problems that the distributor cannot solve.



## 9. Warranty Information

### 9.1 Returns Policy

**IMPORTANT!**  
Please fill out your warranty registration online at [www.daray.co.uk/warranty](http://www.daray.co.uk/warranty) or contact Daray by phone (0800 878 9864) or email [support@daray.co.uk](mailto:support@daray.co.uk)

DARAY's standard warranty is 12 months. However, this period may be extended to 3 years\* free of charge by completing and submitting the warranty registration. For the specific warranty period for this product, please refer to the warranty symbol in the upper right of this page.

Year 1:	Warranty includes parts and labour (Return to Base)	*UK only
Year 2-3:	Parts only	

We want you to be completely satisfied with your purchase. If you need to return goods purchased from DARAY Ltd, please read the following information carefully. The DARAY Ltd returns policy provides guidance on when you can return goods we have supplied, and what you can expect from us once you do. To see our detailed returns policy and procedure visit [www.daray.co.uk/returns](http://www.daray.co.uk/returns)

TYPE OF RETURN	REMEDY
<b>DAMAGED GOODS</b> Goods which are physically damaged on delivery	We must be notified within 24 hours of receipt.
<b>Dead On Arrival (DOA)</b> Goods which do not work	Goods which do not work on arrival or develop a fault within 28 days, we will advance replace the item.
<b>GOODS DEVELOPING A FAULT</b> Goods which have developed a fault within the warranty period.	If the fault develops after 28 days, but within the warranty period, we will initiate the returns procedure.
<b>NON WARRANTY</b> Goods which have developed a fault outside the warranty period.	If a fault develops outside the warranty period, we will initiate the returns procedure charges may be applicable.
<b>OTHER</b> Any situation which is not covered by any of the above.	We will always try to help, but we cannot normally offer a refund.

For additional clarification, please refer to our terms and conditions at [www.daray.co.uk/terms](http://www.daray.co.uk/terms). In a small number of cases, we may determine that a replacement would not work any better than the original product we supplied. In such cases we will only offer a refund rather than a replacement for qualifying returns.

Replacement bulbs and spare parts ordered on our website or from supplied part codes are not eligible for credit. We will accept returns and exchange for the correct item.

If your purchase an item incorrectly you can return it within 14 days and it can be exchanged for another product of equal or higher value, excluding transportation charges incurred. Goods and packaging must be returned in their original condition. Under no circumstances will goods be accepted for return if they are damaged, have been subjected to improper handling or abuse or have been used.

If you send us goods that do not qualify for return, you will invalidate your claim to any refund, and you will be obliged to compensate DARAY Ltd for the cost of return postage and any other reasonable costs incurred processing the goods. Your statutory rights are not affected.

## 9.2 Warranty Details

### TERMS AND CONDITIONS OF WARRANTY

1. To qualify for this warranty you must register on [www.daray.co.uk](http://www.daray.co.uk) or return to Daray Ltd (Daray) the duly completed warranty-registration form accompanying the product.
2. Daray warrants this product (excluding lamp) against faulty material and workmanship during the period of the warranty. The period of warranty is the period stated on your warranty card and commences on the date of purchase of the product. In the event that the product is not in good working order Daray will provide, during the warranty period, a free repair service within the United Kingdom. The warranty is subject to proof of purchase being provided; therefore, you should retain your original receipt.
  - 2.1 The repair service consists of the provision of spare parts and/or replacement products (at Daray's discretion) which will be provided on an exchange basis and will either be new, equivalent to new or reconditioned. All replaced spare parts and products shall become the property of Daray.
  - 2.2 Daray's only obligation under this warranty is the provision of the service as set out above.
  - 2.3 All products are returned to Daray at the customer's cost and risk. Products to be returned should be adequately packed. For the address to send returns to please visit [www.daray.co.uk](http://www.daray.co.uk)
3. Daray's arrangements for providing service provided under this warranty may include the use of sub-contractors.
4. This warranty does not cover damage or defects in the Product caused by or resulting from:
  - Wilful neglect or negligence by anyone other than Daray;
  - Improper use, storage or handling of the product;
  - Use of non-Daray approved parts (such as replacement lamps) not compatible with the Product;
  - Fire, accident or disaster;
  - Use of non-Daray modifications other than in accordance with Daray's instructions;Attachment of fittings and accessories not approved by Daray;  
Repairs, modifications carried out by service personnel not approved by Daray;
  - Damage caused by chemical corrosion from cleaning agents not approved by Daray.
  - Failure to use or install the product in accordance with the manufacturer's instructions.
5. Nothing in this warranty shall have the effect of restricting or excluding the liability of Daray in respect of:
  - a) Death and personal injury caused by the negligence of Daray, or for fraud;
  - b) Under the *Consumer Protection Act 1987* to a person who has suffered damage caused by a defective product or to a dependant or relative of such a person;
  - c) Direct damage to your property caused by the proven negligence of Daray.
6. This agreement does not give any rights other than those expressly set out above and in particular, Daray will not be responsible for any loss of income, profits or contracts or any direct or indirect consequential loss, damage caused to or suffered by the purchaser as a direct result of this agreement.
7. This warranty is offered (subject to these terms and conditions) in addition to, and does not affect your statutory rights.
8. Daray may disclose your details and other personal information to companies within the Daray group including any subsidiary company or sub-contractor of Daray for the purposes of performing our obligations hereunder.
9. You must not resell outside the UK any products supplied by Daray and covered by the *Export of Goods (Control) Order 1992* (or any law that replaces it) without obtaining all necessary licences. You also agree not to sell the product in the UK if you know or think that the person buying the product intends to export it without getting the necessary licences. You agree to impose similar conditions to these on anyone you sell the product to.
10. These conditions shall in all respect be governed and construed in accordance with English law and the exclusive jurisdiction of the English courts.

Product:

Serial No:









**DARAY**<sup>®</sup>  
Medical

**DARAY Ltd.**  
Edison House  
Robian Way  
Swadlincote  
Derbyshire  
United Kingdom  
DE11 9DH



**+44 (0)800 878 9864**



**+44 (0)333 321 0973**

**sales@daray.co.uk • www.daray.co.uk**

---