



Stage 3. CABLING ANTENNA

Coaxial Cable Connection*:

Follow below steps for coaxial cable connection:

1. Remove twist on RG6 male F-connector provided from the sealed poly bag.
2. Fit the balun boot provided onto the cable before screwing the RG6 male F-connector to the end of the cable (Follow steps in Figures 03a - 03c).
3. Fit the newly terminated cable onto the female F-connector provided at rear underside of boom, as shown in Figure 03d. Do not overtighten. Make sure you have a drip loop in the cable before finalising the installation, as this allows the water to run down the cable and "drip" off the loop as shown on figure 2d.

*Cable runs should be made as short and as even in length as necessary.

Splitting the signal for multiple TV sets:

When splitting the signal it is beneficial to make splits as evenly as possible, i.e. in a central location.

Note: A splitter splits the signal to the outputs regardless of the connections made i.e. A 4 to 1 splitter will always give a 1/4 of the power at each output, even if you only connect 1 TV.

Consider using a distribution amplifier if you need to split a weak signal into more than 2 ways, (See option 2 in figure 4).

Note: electronic amplifiers require a good quality signal as an input to ensure a good quality signal is output – the closer to the antenna the better, therefore it is recommended that distribution amplifiers be installed within your roof cavity.

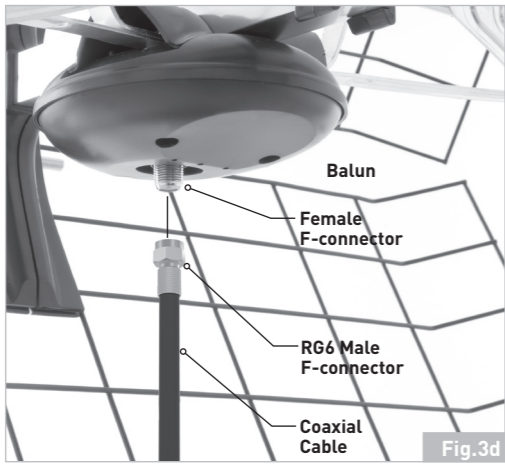
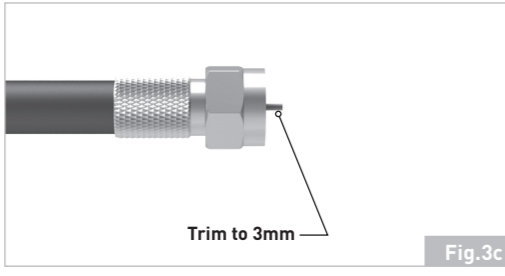
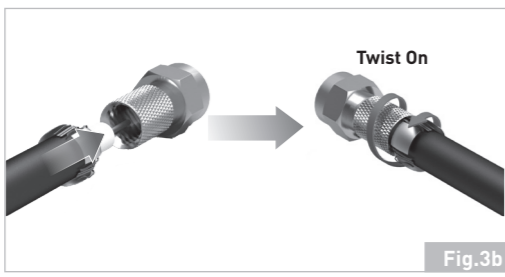
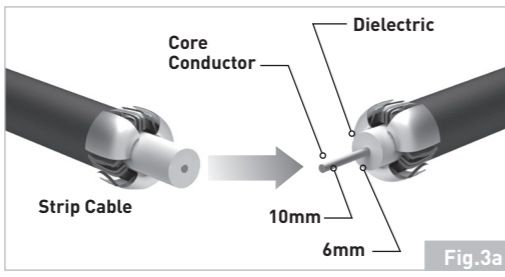

Stage 4. FINAL INSTALLATION

Final installation of the antenna should be done as similar to example below:

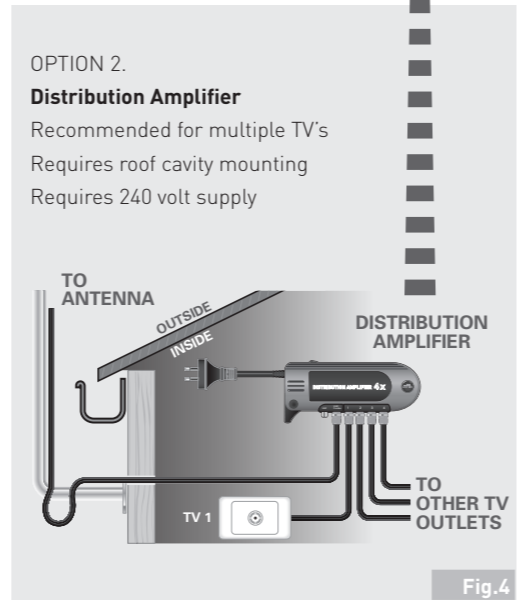
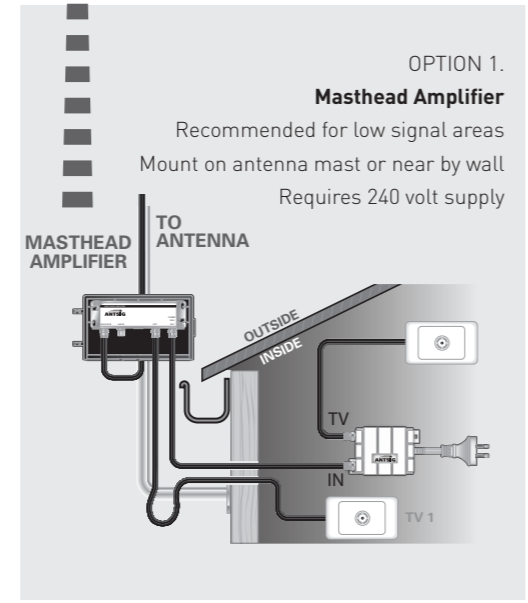
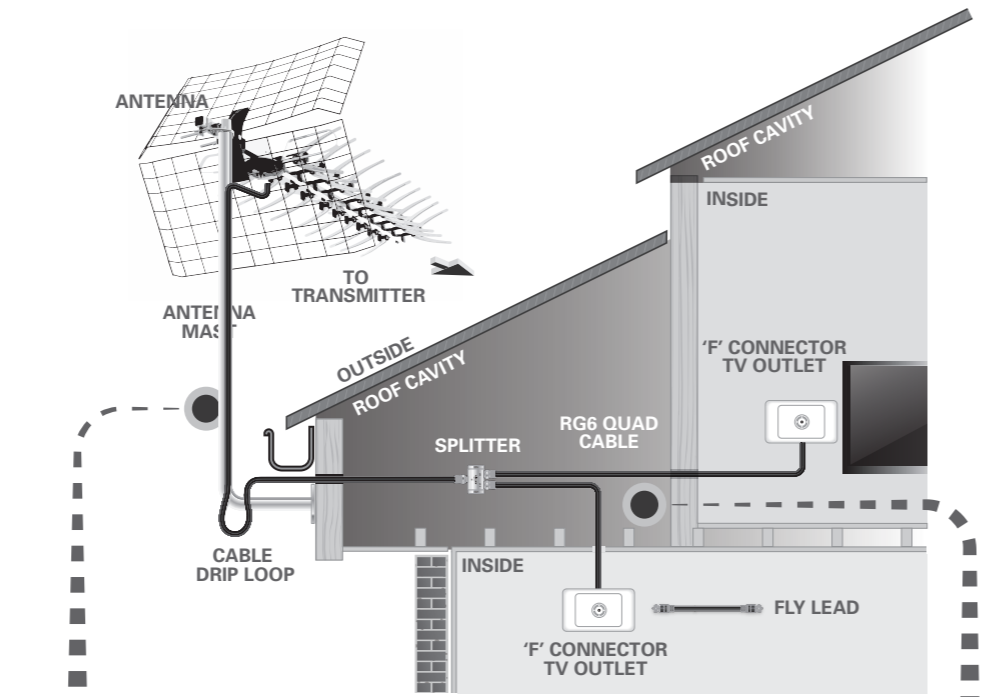

Fig.4

TROUBLESHOOTING & PIXELATION INFORMATION

Digital TV sets now require the received signal level to be within its operating boundaries. A signal level between 45dBµV and 80dBµV is most ideal and will present a perfect picture. If the signal is outside of these levels, pixilation will occur whether it is too much or too little.

The most likely causes of pixilation will be poor signal collection. Though in some cases, having too large an antenna for your distribution network, or an amplifier that is not required, can cause too much signal for your TV. This can be reduced easily with the introduction of a splitter.

To fix or prevent pixilation you can try the following:

- Check antenna direction;
- Check for sources of interference and noise - power cables, exhaust fans, air conditioners, etc. try to avoid running coax cable within close proximity to these;

Warranty

Arlec guarantees this product in accordance with the Australian Consumer Law and all other applicable Australian and New Zealand laws that are unable to be excluded.

Arlec also warrants to the original first purchaser of this product ("you") from a retailer with which this document is given that this product will be free of defects in materials and workmanship for a period of 12 months from the date of purchase; provided the product is not used other than for the purpose, or in a manner not within the scope of the recommendations and limitations, specified by Arlec, is new and not damaged at the time of purchase, has been maintained in accordance with the recommendations specified by Arlec, has not been subjected to abuse, misuse, neglect or damage, has not been modified or repaired without the approval of Arlec and has not been used for commercial purposes ("Warranty").

If you wish to claim on the Warranty, you must, at your own expense, return the product, and provide proof of original purchase and your name, address and telephone number, to Arlec at the address below or the retailer from whom you originally purchased the product within 12 months from the date of purchase.

Arlec will (or authorise the retailer to) assess any claim you may make on the Warranty in the above manner and if, in Arlec's reasonable opinion, the Warranty applies, Arlec will at its own option and expense (or authorise the retailer to) replace the product with the same or similar product or repair the product and return it to you or refund the price you paid for the product. Arlec will bear its own expenses of doing those things, and you must bear any other expenses of claiming on the Warranty.

For goods purchased in Australia (only):

The Warranty is in addition to other rights and remedies you may have under a law in relation to the product to which the Warranty relates.

Our goods come with guarantees that cannot be excluded under the Australian Consumer Law. You are entitled to a replacement or refund for a major failure and for compensation for any other reasonably foreseeable loss or damage. You are also entitled to have the goods repaired or replaced if the goods fail to be of acceptable quality and the failure does not amount to a major failure.

For goods purchased in New Zealand (only):

The Warranty is in addition to, and does not affect, other rights and remedies you may have under a law in relation to the product to which the Warranty relates.

Our goods come with guarantees that can only be excluded under the New Zealand Consumer Guarantees Act 1993 to the extent you are acquiring the product for a business purpose and it would be fair and reasonable for Arlec to contract out of those guarantees.



Arlec Australia Pty. Ltd. ACN 009 322 105 gives the Warranty for goods purchased from a retailer in Australia by you and Arlec New Zealand Limited NZBN 9429030738294 gives the Warranty for goods purchased from a retailer in New Zealand by you (collectively Arlec).

Arlec's telephone number, address and email address for purposes of giving the Warranty are:
 Telephone Number: **1800 826 859 (in Australia)**
0800 003 329 (in New Zealand)
 Street Address: Building 3, 31-41 Joseph Street, Blackburn North, Victoria, 3130, Australia
 Postal Address: Blackburn North LPD, P.O. Box 1065, Blackburn North, 3130, Australia
 Email: custservice@arlec.com.au

DIGITAL HD TV ANTENNA INSTALLATION GUIDE



OUTDOOR TV ANTENNA

UHF
4G/LTE FILTERED

UHF
CHANNELS
21 - 51

FULL HD
1080

4G
FILTER

INSTALLATION GUIDE

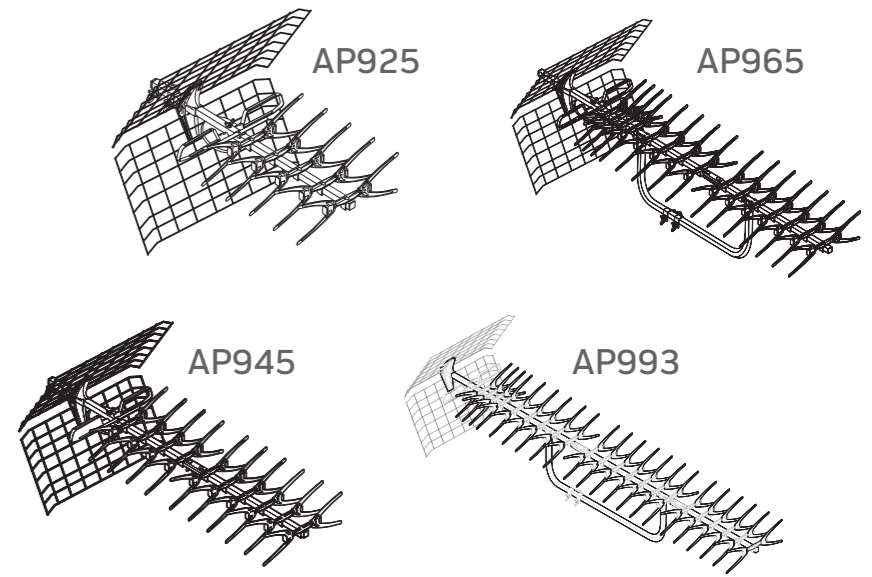

P PRIME M MEDIUM F FRINGE
RECEPTION



Thank you for choosing the Antsig range of quality audio video equipment.

The UHF Range of antennas have been designed and tested in Australia using a state-of-the-art Anechoic Chamber. This ensures that your antenna has been optimised to capture high definition digital TV signals. Successful antenna installation requires strong collection of the TV signal and distribution of the TV signal. Follow these key guidelines for proper installation:

- **Note your position to transmitter towers**
- **Mount antenna high as possible with fewest obstructions in line of sight with transmitter**
- **Use RG6 quad shield cable for installation**
- **Terminate with F-connectors**
- **Keep cable lengths to a minimum**

If, at any time, you are unsure about performing any functions relating to antenna installation, please contact a professional installer.

SAFETY POINTS

Always plan your installation. Carefully think through the job and don't take dangerous shortcuts. Common sense and good judgement must be used at all times; Carefully survey the job before the installation to locate secure roof areas and the most convenient placement for ladders. Work out where the strongest points are for mast and cable mounting; Always let someone know you are working on the roof;

Locate and avoid overhead power lines. Antennas must always be installed away from over-head power lines and preferably at a distance equal to twice the combined length of the mast and antenna; Do not climb on the roof when there is no-one else around;

Wear proper shoes that are non-slip; Do not climb on wet or icy roofs NOR attempt to install the antenna during wet or windy weather; Only use the sturdiest of ladders and ensure they are securely anchored before climbing; Do not step onto roof valleys, these are often weak, even in new homes; Ensure that all roof structures are structurally sound before putting any weight on them or mounting antenna hardware to them; Always remember that you are standing on the roof, take your time and don't be distracted by passersby; If installing an antenna within the roof cavity, ensure that the ceiling will support your weight.

ASSEMBLY

Follow these instructions to install your UHF outdoor antenna:

Stage 1. ANTENNA ASSEMBLY

1. Assemble the antenna boom (with all holes facing upwards) via the 2 bolts and wing nuts, ensuring the upper and lower support brackets seat over the boom squarely.
2. Attach the small bar element to the boom by fitting the seat over the boom, then place the small bar element over the seat, aligning the holes with the small hole in the boom. Using a suitable Philips head screwdriver, tighten screw until small bar element cannot move.
3. Attach loop element assembly to the boom as pictured, ensure correct orientation. Tighten wing nut until firm.

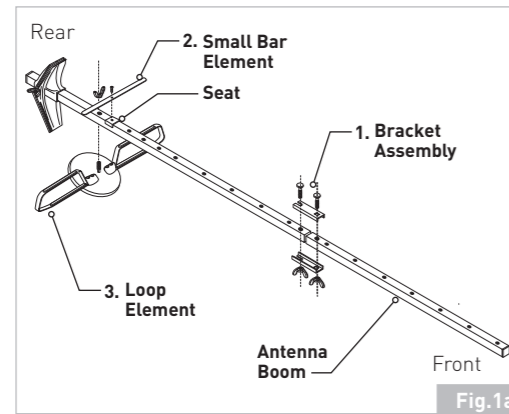

4. Assemble V-element caddy to an available hole in the boom. Press the centre of the caddy with your thumb and lever it onto the boom, slide it to align the pin in the caddy to enter an available receptacle.
5. Repeat until all holes are occupied and all directional arrows are pointed towards the front.

Note: the direction markers are located on top of the V-element caddy. A locating pin is found underneath inside the clasp.

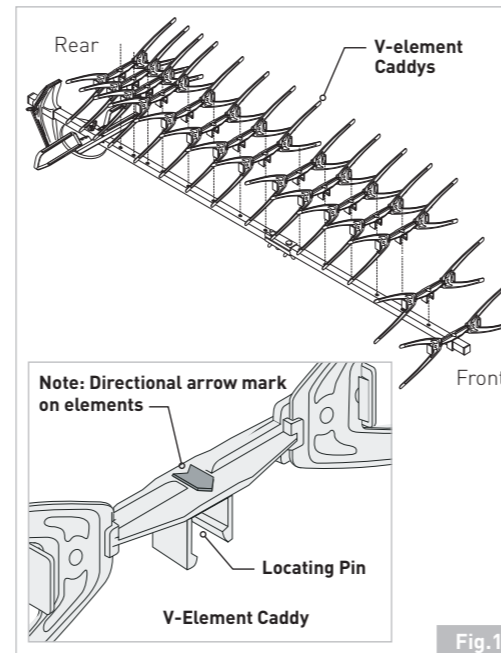

Fig.1b

Exclude Step 6 for AP925 and AP945 (Brace is not required)

6. Attach boom strengthening brace by locating the metal clamps over the boom at the locations shown. It is easier to perform this when the antenna is sitting on a table, upside down.
7. Slide in each of the reflector elements into the plastic fixture. Ensure the smaller mesh squares are inserted to centre the reflector and make sure they seat all the way in.
8. Mount according to selection "Stage 2. MOUNTING ANTENNA"

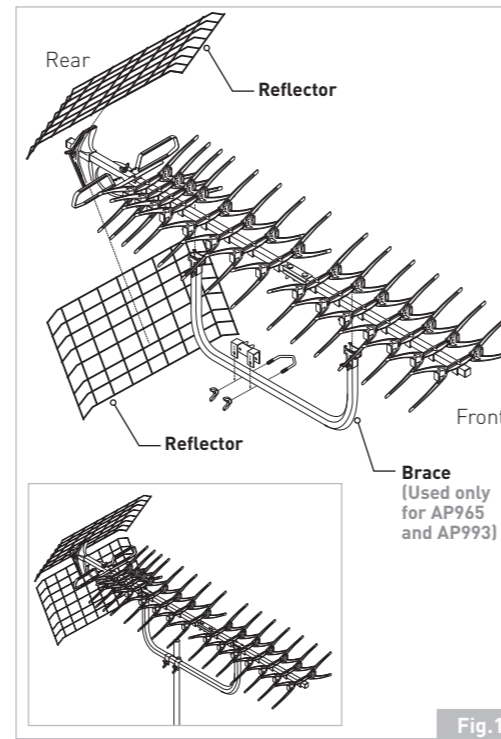

Fig.1c

INSTALLATION

Stage 2. MOUNTING ANTENNA

Mounting the antenna includes considering three factors; position, direction and polarisation.

Position:

Mount the antenna at highest point practicable, the higher the better, whilst also maintaining close proximity to antenna cabling.

Position the antenna at the closest point to the broadcast transmitter; avoid any obstruction between the antenna and the broadcast transmitter. Antenna location should be away from sources of RF noise such as motors.

Direction:

Point front of antenna directly towards broadcast transmitter; if the transmitter is not visible, position antenna in same direction as neighboring antennas; a compass or map can also help.

Using the Antsig signal strength meter (AP9000) can greatly improve your success in achieving the optimal direction for maximum signal strength.

Polarisation:

Transmitter broadcasting direction will determine how the antenna should be mounted. If the transmitter is broadcasting horizontally, the antenna should have horizontal polarisation (antenna should be mounted normal, see figure 2a). If the transmitter is broadcasting vertically, antenna should have vertical polarisation (antenna should be mounted on its side, see figure 2b).

For this reason the antenna clamp slides off the antenna boom to allow for each mounting requirement.

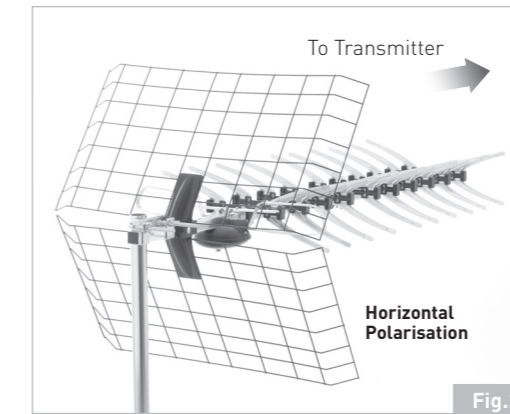

Fig.2a

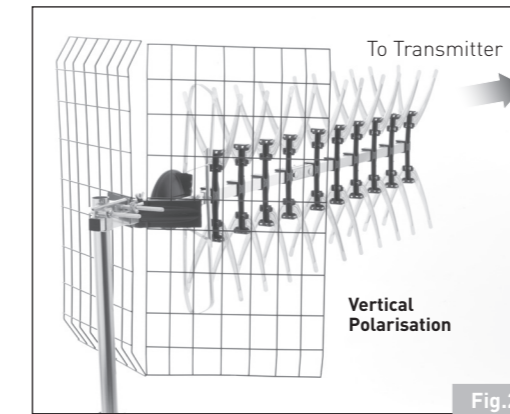

Fig.2b

DIGITAL HD TV ANTENNA INSTALLATION GUIDE

Follow below steps to mount your antenna:

1. Loosen the wing nuts attached to the u-bolt and pull the u-bolt connected to the v-block outwards to provide enough space for the antenna mast to be placed in between.
2. Mount the antenna mast in between the u-bolt and the mounting clamp. Slide the antenna over the mast (See Figure 2c). Direct the antenna towards the transmitter and use a shifter/adjustable wrench to tighten the wing nuts. Use cable ties or tape to secure the coaxial cable to the antenna mast (See Figure 2d). See "Stage 3. CABLING ANTENNA" to know more about coaxial cable connection.

Note: To get best performance from the antenna, mount it outdoors, up high clear from any obstructions and aligned with the transmitter.

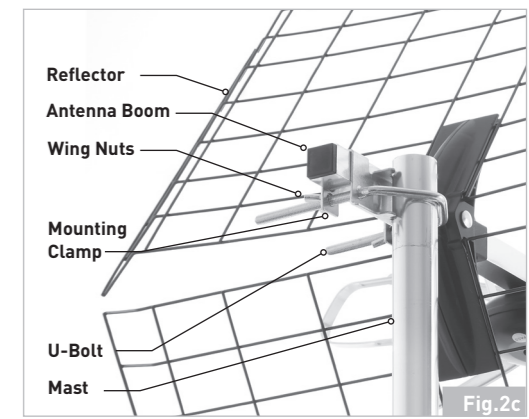

Fig.2c

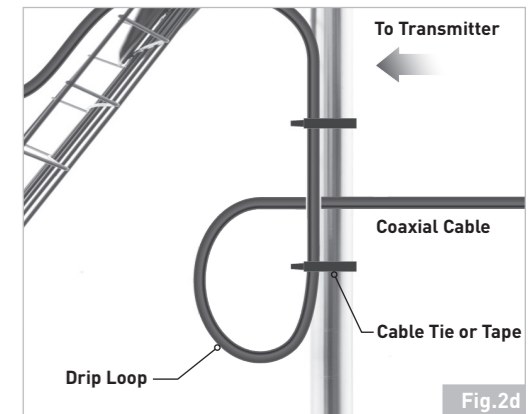

Fig.2d