



**UKEG™**

**Pressurized Growler**

**OWNER'S MANUAL**

**64 & 128**

Hello from the founders of GrowlerWerks.

We'd like to personally welcome you to your new uKeg. Thank you for making GrowlerWerks your choice in keeping beverages fresh and carbonated for more than two weeks. The uKeg is a unique product that gives you the functionality of a full-bar system, letting you be your own bartender wherever you go. Vacuum insulated so your beverage stays cold all day, the uKeg is perfect for keeping craft beer fresh or holding your own cocktail creations and then taking it with you to share with friends.

We hope you enjoy your uKeg for years to come and are here to support you along the way. The uKeg will require some maintenance over its lifetime, and some easy upkeep procedures will be required as components wear. The uKeg comes with a one-year warranty for manufacturing defects, but we will always support you with free email and phone support. Check out the how-to page on our website for a wealth of information on caring for your uKeg and to access our technical-support system.

So please go forth and enjoy your uKeg. May your beer always be fresh, cold, and carbonated!

Cheers,  
Brian, Evan, and Shawn



## Included with your uKeg™:

- 2 CO2 cartridges
- CO2 cartridge sleeve
- Regulator cap
- uKeg
- Surgeon General's warning (required in some states)
- Owner's manual
- Felt protective bag
- GrowlerWerks sticker
- Spare cartridge seal

Visit **GROWLERWERKS.COM/HOWTO** for a full instructional video.



#### INSTALL CARTRIDGE

- Before heading out.
- Ensure dial is in off position.



#### CHARGE CAP

- Tighten sleeve quickly and firmly.
- Sleeve does not need to bottom out.



#### FILL UKEG

- First, rinse with cold water.
- Fill from the bottom with fill-tube.



#### CAP UKEG

- Turn pressure up to desired setting.



#### POUR AND ENJOY

- Tilt glass, hold close to the spout.
- Open tap completely, let go.



**DO NOT** open sleeve when cartridge contains pressure.

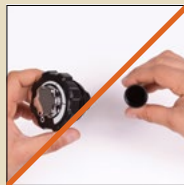

**DO NOT** use without CO2 cartridge.

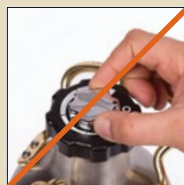

**DO NOT** turn off pressure when uKeg is full. Doing this does not save CO2.

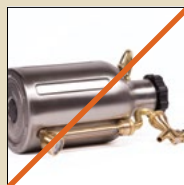

**DO NOT** store or transport uKeg on its side or shake.

**DO NOT** use uKeg with liquids above 120 degrees F.

**DO NOT** polish carry handles or copper-plated uKegs.

#### CARBONATION SETTINGS

Beverage Type	Pressure
Stout, Porter, Cream Ale, Barley Wine	3-6 PSI
Amber, Brown, Red Ale	5-8 PSI
IPA, Pale Ale, Wheat, Other Ales	7-10 PSI
Lager, Pilsner, Cider, Kombucha	9-12 PSI
Sparkling Wine, Soda	12-15 PSI

**UKEG IS NOT DISHWASHER SAFE. BE SURE TO HAND WASH ONLY.**

The uKeg is a complete beverage dispensing system to contain your beverage and keep it cold. Here's a handy map to your uKeg's parts, to help you find your way around.



## VPR CAP Variable Pressure Regulation Cap

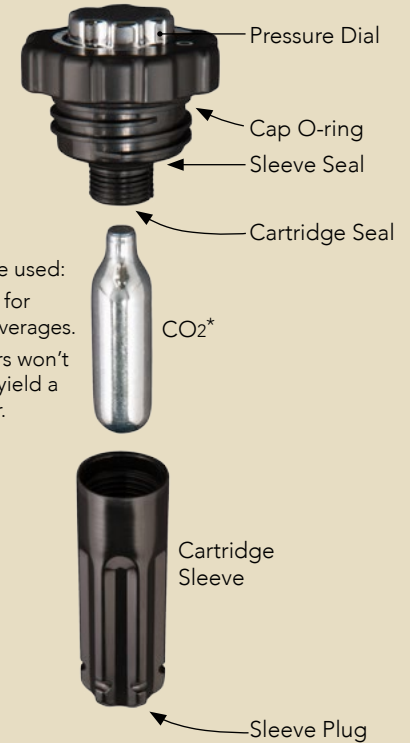

\* Other gases may be used:  
Argon can be used for non-carbonated beverages.  
N<sub>2</sub>O cream chargers won't carbonate but can yield a smoother character.

### RISKS & WARNINGS

- Use precaution when handling CO<sub>2</sub> cartridges and follow all instructions. Keep bottom of cartridge sleeve pointed away from body when installing and removing cartridges. Do not attempt to remove a cartridge from regulator cap if still pressurized.
- Risk of cold burns – CO<sub>2</sub> gas and used cartridges can be very cold. Use caution when handling. Always point the regulator cap's outlet away from body when discharging.
- CO<sub>2</sub> cartridges are to be used for food consumption only and not for sale to minors under the age of 18.
- Do not inhale contents. Misuse can be dangerous to your health.
- This product carries risk of explosion and flying debris.
- Misuse can be dangerous!
- Do not incinerate.
- Do not expose to sun or heat.
- Do not store above 49°C/120°F.
- Keep out of reach of children.

WARNING: While the brass used in this product is FDA-compliant, low-lead alloy, it is not completely lead free. This product contains chemicals known to the state of California to cause cancer and birth defects or other reproductive harm.



Make sure retaining nut is tight.



Sleeve doesn't need to bottom out.



Correct sleeve seal orientation means ridges point down.



Pressure off is counterclockwise.



Cap O-ring tight, smooth

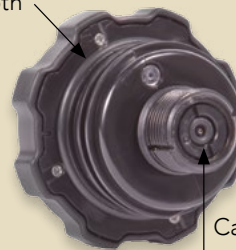

Cartridge seal rounded, smooth, clean

### Installing a cartridge:

- Before installing cartridge, do these things.
  - Make sure the pressure dial is off.
  - Make sure retaining nut is tight.
  - Inspect your seals:
    1. Cartridge seal is not damaged or excessively worn.
    2. Cap O-ring is not stretched or damaged.
    3. Sleeve seal and plug are in good condition. They ensure beer does not contact the CO<sub>2</sub> cartridge.
- Screw the sleeve on quickly.
- Listen for hissing. It should stop within seconds.
- You can always test the cap by hand, turning on the dial slightly, listening for a puff of CO<sub>2</sub>.
- Use only approved CO<sub>2</sub>, as some CO<sub>2</sub> may not fit properly and can lead to leaks ([www.growlerwerks.com/howto](http://www.growlerwerks.com/howto)).

### Removing a cartridge:

- You can turn off the cap and remove it at any time.
- Before unscrewing sleeve, test that it's empty by turning the pressure dial and making sure no hissing is heard.
- Unscrew sleeve slowly and listen for hissing. If heard, stop until hissing stops.
- Before installing the next cartridge, allow the seal to recover its rounded shape.

### What to expect from your cap:

- Cartridge will last for one growler fill, with some left over that can be used during cleaning (see page 7).
- Beer will stay fresh for at least 2 weeks.
- Cartridge seal will last for over 20 fills, unless damaged.
- Long term storage of cap with CO<sub>2</sub> installed reduces cartridge seal life, remove empty cartridges promptly.
- Cap O-ring can become damaged or stretched and may need to be replaced.
- Applying a food grade silicone grease to seals will extend their life.





## POUR A GOOD BEER

- Open tap fully.
- Let go of tap handle.
- Tilt glass.
- Tap will drip a few times when closed – leave glass to catch those precious drops.



## FILLING YOUR UKEG

- Rinse with cold water.
- Fill from the bottom up with a fill tube with the tap open.
- Put cap on yourself, to avoid overtightening.



## TRANSPORT

- Secure upright.
- Lower pressure.
- May vent with elevation increase.



## KEEP IT COLD

- Perfect in your refrigerator door.
- Keep out of direct sunlight to prevent fittings from getting hot.
- Store in a cooler – it's OK if it gets wet.



## GOOSENECK

- Can turn sideways.
- Turn to transport or dispense sideways.
- Sometimes nut will be tight and gooseneck may still feel loose – that's OK.

## TO MINIMIZE FOAMING

- Keep uKeg clean.
- uKeg pressure should match beer line pressure at fill station.
- Allow to settle after transport.
- Avoid warming.

## WHAT NOT TO PUT IN THE UKEG

- No liquids over 120°F.
- No solids – they may clog.
- Do not use uKeg for fermentation.

## INSULATION

- Stays cold 8 hours or more.



## HAND WASH ONLY



1.

Remove cap and rinse uKeg with hot water (< 120° F).

- Repeat 3 times.



2.

Rinse cap and sleeve with hot water (< 120° F).

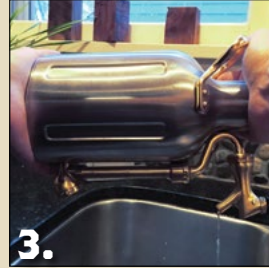

3.

Shake with tap open, facing downward.

- Water may or may not come out of tap.
- Repeat until water runs clean.

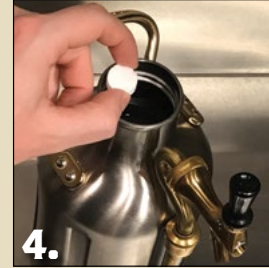

4.

Fill with warm water under 120° F and 1 cleaning tablet.\*

- Shake well.

\* Baking soda is acceptable substitute.



5.

Install cap, charge briefly, flow a little water through tap, close tap.

- Let sit for 10 minutes.
- Then open tap until uKeg is empty or pressure runs out.



6.

Empty bottle and rinse all parts.

- Thoroughly rinse tap lock.
- Move lock several times during rinse.



7.

Allow to dry, and store with cap off and tap open in a dry place.



**UKEG CLEANING  
TABLETS  
AVAILABLE AT  
GROWLERWERKS.COM**

The uKeg is a complete beverage dispensing system, and it will experience some wear and tear as it ages. As with a commercial system, you can expect to replace a few seals and components but the uKeg is designed to make this simple. Here are a few of the most common procedures you may encounter. For more information on these and other aspects, plus videos of maintaining your uKeg, please visit **[WWW.GROWLERWERKS.COM/HOWTO](http://WWW.GROWLERWERKS.COM/HOWTO)** or contact technical support.

**CARTRIDGE SEAL REPLACEMENT**

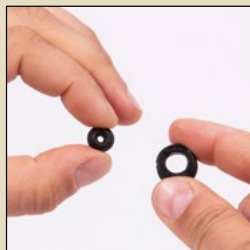

Use a butter knife or keys if you do not have a uKeg tool.

**CAP SEAL REPLACEMENT**



Stretch O-ring just enough for installation.

**TAP CLEANING**

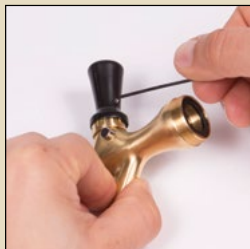

Use 1.5mm allen wrench.

**PRESSURE GAUGE REPLACEMENT**



\*See page 14 for detailed uKeg diagrams.



## COPPER AND BLACK CHROME UKEGS:

The color of your uKeg is actually a metal coating that is electroplated onto the stainless steel bottle in a thin layer and then covered with a protective lacquer finish.

Your copper uKeg should not corrode or turn green, but it can be expected to darken slightly over time.



- To clean, gently wash with soap and water or mild detergents.
- To remove spots, discoloration, or minor blemishes, gentle rubbing with a soft cloth and water is recommended.
- Do not use polishing compounds or abrasive pads to polish the copper or black chrome surfaces.
  - Spot cleaning this way can remove the lacquer finish which can later lead to green corrosion.
  - Polishing with compounds can completely remove the plated metal layer and expose the stainless steel beneath.

Over time, the coating will experience wear and tear and the copper coating may eventually develop an aged patina. This is expected and is part of the character of your copper-plated uKeg. It, in part, tells the story of where you and your uKeg have been together.

## REMOVING THE TAP HANDLE

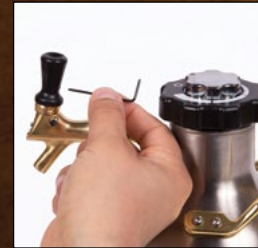



Instructional video on our website:  
[WWW.GROWLERWERKS.COM/HOWTO](http://WWW.GROWLERWERKS.COM/HOWTO)



## FORCE CARBONATING HOMEBREW:

- 1 Fill the uKeg to the fill line with your beer after fermentation.
  - Do not add priming sugar.
  - If you bottle, add the priming sugar to the bottling bucket after filling the uKeg.
  - Remember to adjust your sugar addition for actual volume of beer you'll be bottling.
- 2 Install CO<sub>2</sub> into cap and install cap onto uKeg.
- 3 Purge oxygen from uKegs:
  - Turn on cap to 1-2 psi then turn off again.
  - Loosen cap slightly to vent pressure.
  - Tighten and repeat once.
  - Tighten fully and turn up pressure.
- 4 Turn up pressure to 15psi.
- 5 Swirl gently then refrigerate.
  - Excessive shaking can allow beer into cap.
- 6 Swirl frequently to accelerate carbonation.
- 7 Beer will be fully carbonated in 2-3 days.
- 7 Reduce carbonation to desired level.
  - Indicated pressure will lower only after a little beer is poured.
- 8 After first pour, uKeg may run out of pressure as all of the CO<sub>2</sub> has gone into the beer.
  - For the uKeg 64, you can purchase the 16gm sleeve and use a 16gm cartridge to avoid this.
- 9 Open uKeg and install new CO<sub>2</sub> cartridge.
- 10 Purge O<sub>2</sub>.
- 11 Enjoy!

## RED BRUT



### Ingredients:

- 1 uKeg™ 128
- 1 Bottle – Wild Roots Raspberry Infused Vodka (or any vodka + raspberries)
- 3 Liters – Torre Oria Brut (champagne, moscato, or prosecco)
- 1 Lemon
- 1 Box Raspberries
- 1 Bundle Mint Leaves

### Instructions:

Pour entire bottle of Wild Roots Raspberry Infused Vodka & 3 liters (four 750 ML bottles) Torre Oria Brut into uKeg 128.

Charge the cap with CO<sub>2</sub> (using a 16-gram cartridge ensures you'll have enough CO<sub>2</sub> to carbonate and dispense).

Grab your flute.

Drop 3 raspberries and a leaf of mint into flute (slap mint to charge flavor).

Pour your beverage into flute, and garnish with lemon peel.

Enjoy.

**WARNING:** This combination is meant for those who enjoy the more tart side of life. The bite is as strong as its bark. To sweeten that, we suggest using a moscato, 5 tablespoons of honey, or both!

## EASTSIDE MULE



### Ingredients:

- 1 uKeg™ 64
- 1 Bottle – Eastside Distilling Below Deck Ginger Rum
- 4 Pack – 12 oz Reed's Extra Ginger Beer
- 1 Bottle Natural Lime Juice (found at any local grocery store)

### Instructions:

Measure 20 ounces of Eastside Distilling Below Deck Ginger Rum, 40 ounces of Reed's Extra Ginger Beer & 4 ounces of lime juice.

Pour measurements into uKeg 64.

Stir these ingredients for 30-40 seconds.

Charge the cap with CO<sub>2</sub> (using an 8-gram cartridge ensures you'll have enough CO<sub>2</sub> to carbonate and dispense).

Place the cap on the uKeg and turn the pressure up to 15 psi, which will keep the correct level of carbonation in the ginger brew and ensure you taste that kick unique to a moscow mule.

Grab a glass, drop in a few ice cubes, pour, sip, repeat.\*

You can adjust the dial to automatically maintain perfect carbonation.

*\*Keep uKeg in refrigerator to ensure fresh pours to the last drop.*

TROUBLESHOOTING	SOLUTION
Leaks gas as soon as the cartridge is installed.	<ul style="list-style-type: none"> <li>• Make sure regulator dial is off, turned all the way counter clockwise.</li> <li>• Tighten the cartridge seal retaining nut.</li> <li>• Replace cartridge seal if it is damaged.</li> </ul>
The tap is open, but no beer comes out.	<ul style="list-style-type: none"> <li>• Make sure a CO<sub>2</sub> cartridge is installed, the cap is turned on, and pressure is indicated on the pressure gauge.</li> <li>• Turn off cap and remove from uKeg. Turn on dial slightly until hissing is heard. If no hissing is heard and you are certain the cartridge is not empty, contact technical support for a cap replacement.</li> <li>• Tap assembly may be clogged. Do not use liquids with solid matter such as fruit larger than 1/32". Clean the uKeg, and disassembly may be required.</li> </ul>
Runs out of pressure in a day or two.	<ul style="list-style-type: none"> <li>• Make sure cap is turned on and left on. (Do not turn cap off once the uKeg is pressurized.)</li> <li>• Ensure the cap is firmly tightened.</li> <li>• Verify that the cap O-ring is not pinched or damaged.</li> <li>• Verify that the cartridge seal is not damaged and the cartridge seal retaining nut is tight.</li> <li>• If you hear hissing or none of the above restore proper function, contact technical support.</li> </ul>
Holds pressure for over a week, but runs out of CO <sub>2</sub> before beer is gone.	<ul style="list-style-type: none"> <li>• There may be a slow leak. Follow the "runs out of pressure" steps to correct.</li> <li>• Beer may be undercarbonated to start, and CO<sub>2</sub> is being absorbed by the beer over time.</li> </ul>
Tap/gooseneck can turn from side to side.	<ul style="list-style-type: none"> <li>• This is normal. Gooseneck may be turned to the side for transport or to pour from the side if desired.</li> <li>• If too loose, tighten the nuts on either end of the gooseneck.</li> </ul>
Tap lock is stuck.	<ul style="list-style-type: none"> <li>• Beer has dried in the tap lock.</li> <li>• Run just the tap assembly under hot water. Push on tap lock with your thumb in the bowl of a metal spoon, bracing against other side of tap during the rinse.</li> <li>• Work back and forth while running under hot water.</li> <li>• Always rinse the tap lock under hot water when cleaning uKeg.</li> </ul>

Free email and phone support for life!

**Customer Service**  
Service@GrowlerWerks.com

TROUBLESHOOTING	SOLUTION
Pressure gauge only reads 0 psi or never changes.	<ul style="list-style-type: none"> <li>• Dial may be temporarily stuck. Tap on face of gauge while under pressure.</li> <li>• Beer may be dried in the gauge. Follow pressure gauge cleaning procedure.</li> <li>• Gauge may be damaged. Contact technical support for assistance.</li> </ul>
Pressure gauge stuck above 0 psi when off.	<ul style="list-style-type: none"> <li>• Beer may be dried in the gauge. Follow pressure gauge cleaning procedure.</li> <li>• Gauge may have been overpressurized or developed an internal defect. Contact technical support for assistance.</li> <li>• If damaged by a drop or impact, a new pressure gauge may be purchased on the website.</li> </ul>
Tap continues to drip without stopping when closed and locked.	<ul style="list-style-type: none"> <li>• A few drips after closing the tap are normal, but it should not drip over time.</li> <li>• Debris may be upsetting the internal tap seal. Follow tap cleaning procedure.</li> <li>• If uKeg continues to drip after cleaning, internal O-ring may have worn through use and be in need of replacement. Replacement seals can be purchased from the website.</li> <li>• If the above do not address the problem, please contact technical support for assistance.</li> </ul>
Beer pours foamy every time (more than ¼ cup of foam).	<ul style="list-style-type: none"> <li>• First pour may be foamy if the beer line is full of air after being filled or the tap assembly has been allowed to warm up. Second beer should pour fine, if that's the case. Always fill uKeg with tap open and keep out of the sun.</li> <li>• Beer may be highly carbonated from bar or brewery. If beer in uKeg is pressurized at 5 psi but came from brewery beer lines pressurized at 25 psi, beer will pour foamy until the pressure equalizes after a few days in the uKeg.</li> <li>• Be sure to open the tap handle fully and let go during the pour. Attempting to meter the flow during the pour can lead to foaming.</li> <li>• Beer line may be dirty or clogged. Clean the tap assembly.</li> <li>• If foaming only after the beer level drops below the upper fitting, there is an internal leak in the uKeg. Contact technical support for assistance.</li> </ul>



**TAP ASSEMBLY**

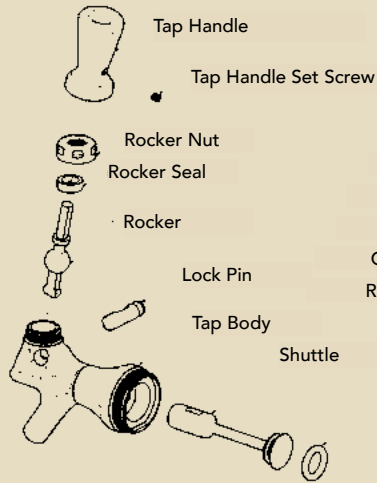

**VPR CAP BOTTOM ASSEMBLY**

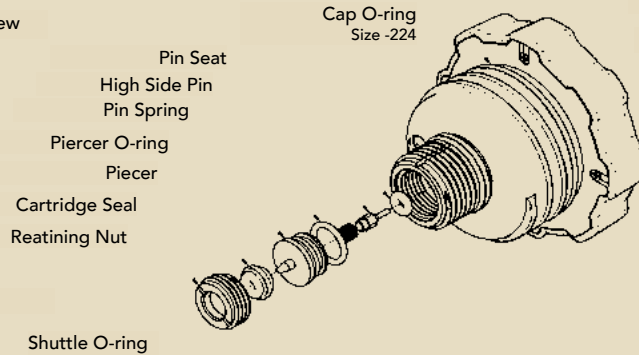

**SIGHT TUBE ASSEMBLY**

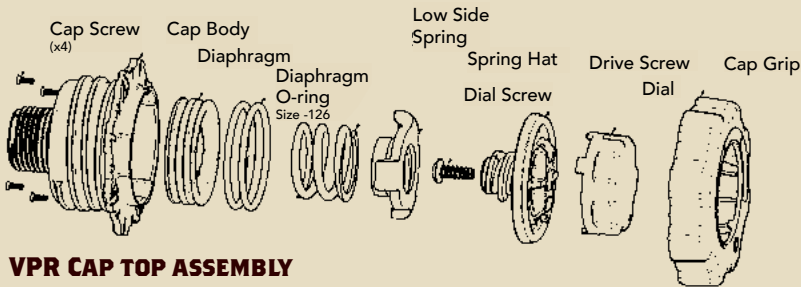
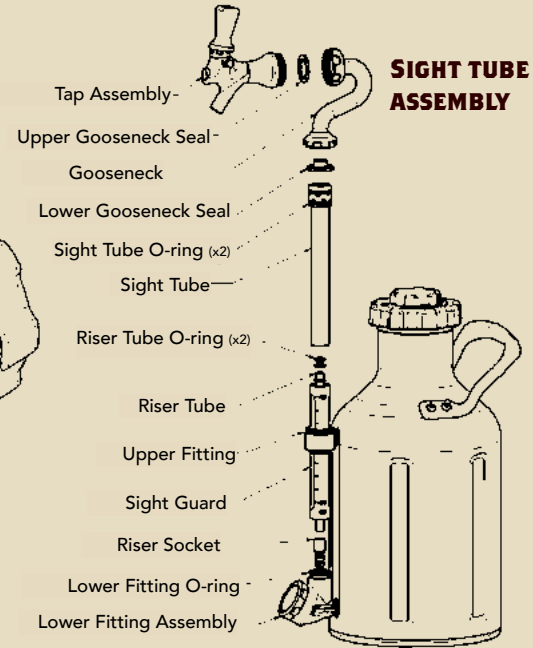

**VPR CAP TOP ASSEMBLY**

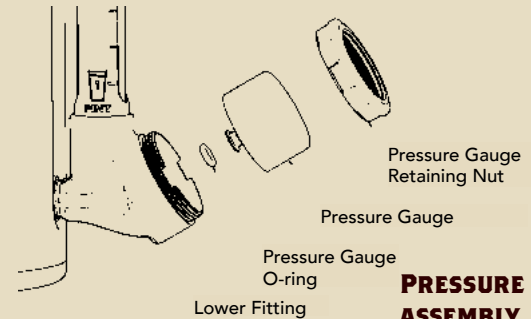

**PRESSURE GAUGE ASSEMBLY**

The uKeg™ comes with a limited one-year warranty from date of receipt of a new purchase from an authorized retailer.  
Please read the full warranty at: [www.growlerwerks.com/warranty](http://www.growlerwerks.com/warranty).

Product may be returned for a full refund after it is verified new and unused.  
Please read the full refund policy: [www.growlerwerks.com/return-policy](http://www.growlerwerks.com/return-policy).

Questions or concerns?  
Contact us at [info@growlerwerks.com](mailto:info@growlerwerks.com) or call 971-266-1477.



## REGISTER YOUR UKEG

Registering your uKeg gains you access to customer service. It also ensures that your one-year warranty is properly applied.

[WWW.GROWLERWERKS.COM/REGISTRATION](http://WWW.GROWLERWERKS.COM/REGISTRATION)



Visit **GROWLERWERKS.COM**  
for more helpful uKeg™ products.



CO2 cartridges



Bar mats



Maintenance kits



Wooden carrying case



Cleaning tablets



Wooden tap handles