

THE LEADER IN FALLING OBJECT PREVENTION

GRIPPS[®]

PRODUCT CATALOGUE
EDITION 7

TABLE OF CONTENTS

14 TOOL CONNECTORS

- 15 TOOL RING
- 15 SCREWLOCK CABLE
- 15 GRIPPLOCK CABLE
- 16 TOOL CATCH
- 16 TOOL CATCH - NON CONDUCTIVE
- 16 V-GRIPP TAPE
- 16 V-GRIPP TAPE & TOOL CATCH KIT
- 17 GRIPP SHRINK
- 17 SWIVEL CATCH
- 17 TOOL-HITCH 16KG | 35LBS
- 17 SINGLE ARM TOOL-HITCH 16KG | 35LBS
- 18 DUAL ARM TOOL-HITCH 16KG | 35LBS
- 18 HEAVY DUTY TOOL-HITCH - 36KG | 79LBS
- 18 PHONE & TABLET GRIPPER
- 19 LITTLE GRIPPER KIT
- 19 E-CATCH
- 19 BOLT GRIPPER

20 GLOVES & WRISTBANDS

- 25 C5 FLEXILITE MKII
- 25 C5 FLEXILITE IMPACT MKII
- 25 C5 ECO GLOVE
- 26 C5 ECO IMPACT GLOVE
- 26 SLIP-ON WRIST ANCHOR
- 26 ADJUSTABLE WRIST-ANCHOR

27 TOOL TETHERS

- 28 BUNGEE TETHER DUAL-ACTION 7KG | 15LBS
- 28 BUNGEE TETHER DUAL CARABINER DUAL-ACTION 7KG | 15LBS
- 28 BUNGEE TETHER SINGLE-ACTION 2.5KG | 5.5LBS
- 28 BUNGEE TETHER TRIPLE-ACTION 7KG | 15LBS
- 29 BUNGEE TETHER HEAVY-DUTY DUAL-ACTION 18KG | 40LBS
- 29 WEBBING TETHER HEAVY-DUTY DUAL-ACTION 15.9KG | 35LBS
- 29 WEBBING TETHER EXTRA HEAVY-DUTY DUAL-ACTION 36.9KG | 81LBS
- 30 COIL TETHER DUAL-ACTION 2.3KG | 5LBS
- 30 COIL TETHER SINGLE-ACTION 1KG | 2LBS
- 30 COIL TETHER SINGLE-ACTION (NON-CONDUCTIVE) 2.5 KG | 5.5LBS
- 30 WEBBING WRIST TETHER DUAL-ACTION 2.5KG | 5.5LBS
- 31 WEBBING WRIST TETHER SINGLE-ACTION 2.5KG | 5.5LBS
- 31 WEBBING TOOL TETHER/SHOULDER STRAP - 5KG | 11LBS
- 31 COIL HARD HAT TETHER
- 31 COIL HARD HAT TETHER (NON-CONDUCTIVE)

- 33 COIL E-TETHER WITH POLY CLIP & E-CATCH (NON-CONDUCTIVE)
- 33 COIL E-TETHER WITH STEEL CLAMP & E-CATCH
- 33 COIL E-TETHER WITH POLY CLAMP & E-CATCH (NON-CONDUCTIVE)
- 34 COIL E-TETHER WITH DUAL LOCKING CARABINER & E-CATCH
- 34 GEAR KEEPER RETRACTABLE TOOL TETHER WITH LOCK
- 34 GEAR KEEPER TOOL TETHER CONNECTOR
- 35 TOOL GRAPPLE® WITH AUTO-STOP
- 35 TOOL GRAPPLE® WITH DUAL LOCKING CARABINER
- 35 STEEL CABLE RETRACTOR UNIT
- 35 KEVLAR CABLE RETRACTOR WITH AUTO-STOP
- 36 DUAL-ACTION CARABINER 2.5KG | 5LBS
- 36 SAFETY GLASSES TETHER

37 BAGS & POUCHES

- 38 MULE BAG 80KG | 176LBS
- 38 MULE TOOL BACKPACK 20KG | 44LBS
- 39 BISON BAG 45KG | 99LBS
- 40 BULL BAG - 113KG | 249LBS
- 40 ZIP-LOCK BAG - 30KG | 66LBS
- 41 LOCKJAW CLIMBERS BAG 10KG | 22LBS
- 41 LOCKJAW RIGGERS BAG 5KG | 11LBS
- 41 LIFTING BAG INSERT
- 42 SCAFFOLD TUBE LIFTING BAG 45KG | 100LBS
- 42 SEAL BAG 20KG | 44LBS
- 43 GRIPPS TETHERING STATION (G.T.S)
- 44 BOLT-VAULT 2.5KG | 5LBS
- 44 BOLT-SAFE POUCH 5KG | 11LBS
- 44 BOLT-SAFE RAIL BAG 5KG | 11LBS
- 45 SECURPULLEY WITH FIXED MOUNT
- 45 SWIVEL MOUNTING ARM

46 TOOL CONNECTOR PACKS

- 47 NIPS - 1KG/2.2LB SOLID TOOL CONNECTOR PACK FOR TOOL BELT
- 47 HAMMER - 2.5KG/5.5LB SOLID HANDLE CONNECTOR PACK FOR TOOL BELT
- 47 MEASURING TAPE CONNECTOR PACK FOR TOOL BELT
- 48 SCAFFOLD KEY & LEVEL CONNECTOR PACK FOR TOOL BELT
- 48 RATCHET/WRENCH - 1KG/2.2LB OPEN TOOL CONNECTOR PACK FOR TOOL BELT
- 48 2X TOOL OPEN CONNECTOR PACK

TABLE OF CONTENTS

49 TOOL BELTS & HOLSTERS

50	COMFORT WORK BELT WITH BACK SUPPORT
50	ERGO-MOTION BACK SUPPORT
50	REINFORCED SYNTHETIC WORK BELT
50	ECONO BELT
51	BOA HOLSTER
51	LEATHER WORK BELT
51	BELT-LOOP ANCHOR
51	CLAW HAMMER HOLSTER
52	SCAFFOLD KEY HOLSTER
52	RATCHET/WRENCH HOLSTER MKII
53	SINGLE TOOL HOLSTER MKII
53	DUAL TOOL HOLSTER MKII
54	TAPE MEASURE HOLSTER MKII
54	TAPE MEASURE LATCH
54	TAPE MEASURE CATCH
55	ADJUSTABLE TWO-WAY RADIO HOLSTER
55	MONITOR/RADMAN HOLSTER
56	WATERBOY
56	WATERBOY XL
57	BATTERY CATCH HOLSTER

58 TRADE KITS

59	THE DROP BOX
60	THE DROP STORE
61	CRANE CREW KIT
61	RIGGERS TRADE KIT
61	SCAFFOLDERS TRADE KIT
62	BOILERMAKER/WELDERS TRADE KIT
62	ELECTRICAL TRADE KIT
62	MECHANICAL FITTERS TRADE KIT
63	DIY ESSENTIALS KIT
63	MULE BAG KIT
63	MULE TOOL CONQUER KIT
64	TELCO KIT
64	FACADE WORKERS KIT
64	(M)EWP TOOL TETHER KIT
65	ESSENTIALS 10 TOOL TETHER KIT
65	10 TOOL TETHER KIT WITH BULL BAG
65	40 TOOL TETHER KIT
65	WITH BULL BAG & BOLT-SAFE POUCH
66	60 TOOL TETHER KIT
66	WITH BULL BAG & BOLT-SAFE POUCH
66	WIND TECHNICIAN KIT
66	WIND TECHNICIAN KIT PLUS
67	DUAL TOOL BELT KIT
67	DUAL TOOL PLUS BELT KIT
68	GRAB-AND-GO - SOLO KIT
68	BELT KIT GRAB-AND-GO - DUAL
68	BELT KIT GRAB-AND-GO - DUAL PLUS
69	PPE DROP PREVENTION PACK
69	PPE DROP PREVENTION PACK WITH RADIO

70 BELT KITS

71	SCAFFOLDERS KIT- 7 TOOL RETRACTABLE
72	SCAFFOLDERS KIT - 7 TOOL RETRACTABLE
72	WITH TOOL CONNECTOR KITS
73	SCAFFOLDERS KIT- 7 TOOL BUNGEE
73	SCAFFOLDERS KIT- 7 SKIN
73	SCAFFOLDERS KIT- 7 SKIN RETRACTABLE
74	SCAFFOLDERS KIT- 5 TOOL RETRACTABLE
74	SCAFFOLDERS KIT- 5 TOOL BUNGEE & COIL
74	FORMWORKERS KIT - 5 TOOL RETRACTABLE
74	(BOLT-SAFE POUCH EDITION)
75	FORMWORKERS KIT - 5 SKIN RETRACTABLE
75	(BOLT-SAFE POUCH EDITION)
75	BATTERY TOOL HOLSTER BELT RETRACTOR KIT
75	BATTERY CATCH HOLSTER BELT RETRACTOR KIT

76 ENCAPSULATION & MATTING

78	GAP WRAP 12" / 24" /36"
79	GAP MAT
80	GAP SCREEN
81	GRIPPGRID
82	MODULAR DROP MAT
82	GRIPPAIR

83 DROP ZONE MANAGEMENT

84	STOP THE DROPS CAMPAIGN PACK
84	MANDATORY SIGN
84	DROP ZONE BARRIER TAPE
84	BUNTING SAFETY FLAGS ON ROPE

85 TETHER READY TOOLS

86	STAINLESS STEEL SCAFFOLD KEY 1/2
86	STAINLESS STEEL SCAFFOLD KEY 7/16
86	SCAFFOLD RATCHET
86	SHIFTER - 10"
87	OX CLAW HAMMER - 20OZ
87	GRIPPS NIPS
87	STABILA MAGNETIC SCAFFOLDERS LEVEL
87	SCAFFOLDERS TAPE MEASURE

OUR MISSION

ELIMINATING CRITICAL RISKS AND SAVING WORKERS' LIVES

WHAT WE DO

GLOBAL LEADERS IN TOOL TETHERING & DROP PREVENTION SOLUTIONS.



Global leader in tool tethering and drop prevention solutions.

At GRIPPS we eliminate critical risks and save lives by creating innovative, convenient & high-quality dropped object prevention solutions. Our dedication to gaining a deep understanding of height worker's needs, ensures the GRIPPS system and training packages are uniquely suited to at-height tasks and are readily implemented on projects globally.

- ✓ **Global leaders in dropped object prevention solutions**
- ✓ **Innovative, functional, certified and effective product range**
- ✓ **Agile team that can respond rapidly to client requirements**
- ✓ **Committed to partner with industry**

UNRIVALLED

LONG-LASTING. PREMIUM QUALITY. INNOVATIVE HEIGHT SAFETY EQUIPMENT.



**TETHERS &
ANCHORS**



**TRADE
KITS**



**ENCAPSULATION
DEVICES**



**LIFTING &
STORAGE BAGS**



SAFETY SINCE 1993

**WE PROVIDE THE BEST TOOL
TETHERING EQUIPMENT
WORLD-WIDE.**

Work at heights with peace of mind knowing your tools are secured by world-class tool tethering equipment when you choose GRIPPS. Built for the harshest environments, offering superior safety, durability and practicality the GRIPPS innovative range helps thousands of workers across industrial sectors globally every day.

END-TO-END SOLUTIONS



INNOVATIVE PRODUCTS



PROFESSIONAL TRAINING



WORK SITE AUDITING



WORKSHOPS

The comprehensive range of GRIPPS solutions has been engineered to eliminate one of the biggest hazards on height projects across the globe. Innovative, functional & certified the GRIPPS range of equipment will deliver a significant safety advance on any height project and our training and awareness packages will promote and nurture a culture of dropped object prevention with all stakeholders.

WE LOVE INNOVATION

GRIPPS has become well-known for innovation in the safety market. We strive to bring impactful, lasting and efficient products that meet the need of our customers. We work directly with end users and stakeholders from companies across various industries and understand the dangers of working at height.

Our team is committed to the highest level of consideration and design for every product. We pride ourselves on the relationships built with our customers and always ensure complete satisfaction and trust in the products that GRIPPS develop.

This commitment to customer satisfaction has allowed GRIPPS to become one of the world's leading suppliers of safety products.

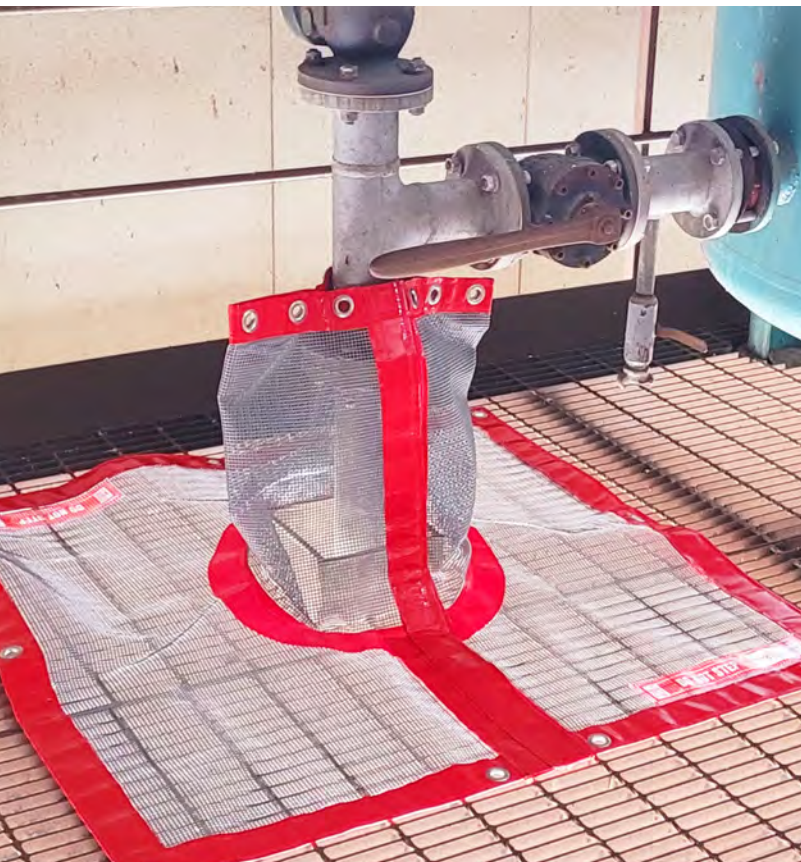
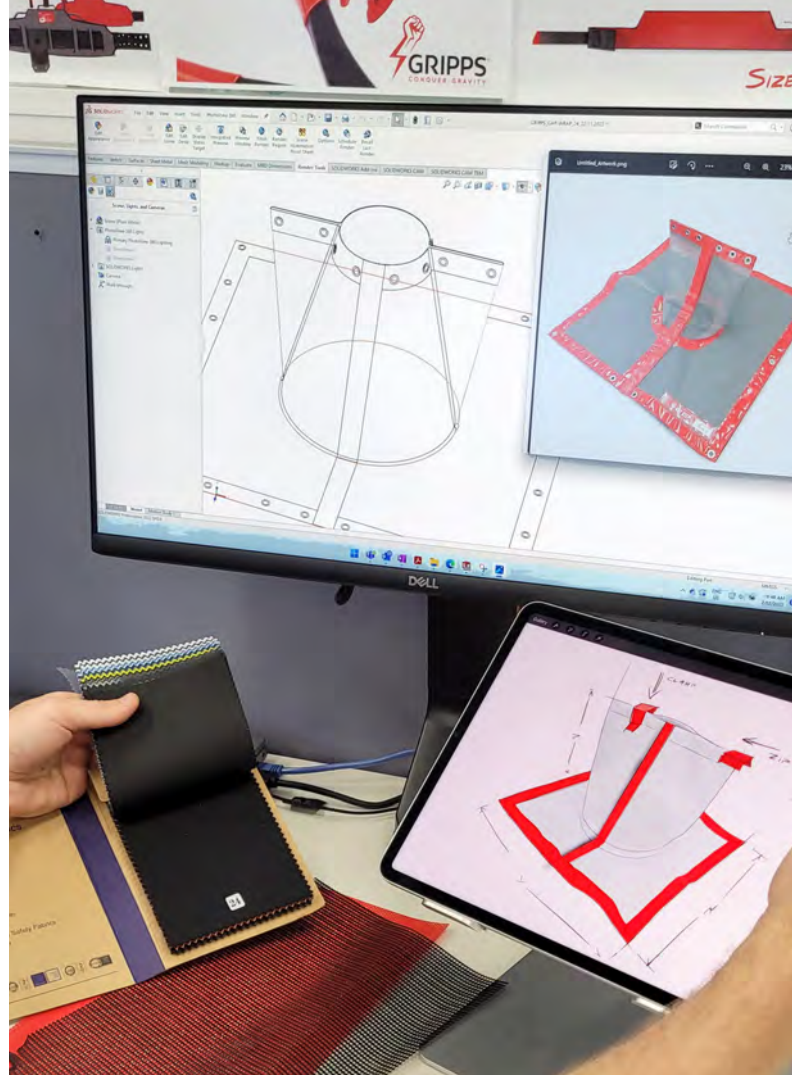

If a custom solution is what you need,
please email innovation@grippsglobal.com

CUSTOM PROJECT?

Are you having trouble finding a solution to a specific risk on your worksite? Its possible that the product you need simply just does not exist yet! This is where GRIPPS can help.

Working closely with companies around the globe we have developed many custom solutions.

For example, GRIPPS 'Gap Wrap' was a result of the close work with Bechtel Corporation. Bechtel Identified a void around floor penetrations that needed a better solution. So, GRIPPS generated concepts, created prototypes and refined the design before successfully releasing the 'Gap Wrap' range in 2022.

INDUSTRY LEADING DROP PREVENTION TRAINING

Available on-site, in our dedicated GRIPPS academy or 100% online, get theoretical & hands on training in tool tethering and drop prevention best practices.

Our course will teach your workers about the vital knowledge they need for working at height and how to effectively use tool tethering equipment with all types of tools.

If your team require training, then partner with GRIPPS today. Reach your safety training goals faster and easier with GRIPPS. We act as strategic safety training partners and even offer customized training solutions that helps drive implementation.

SKU: H05000

Dropped Object Prevention
Face-to-Face Training Course 1/2 Day

SKU: H05001

GRIPPS Online Training - Single User

SKU: H05002

GRIPPS Online Training 50x Users
(45 paid users + 5 FREE)

SKU: H05003

GRIPPS Online Training 100x Users
(90 paid users + 10 FREE)

SKU: H05004

GRIPPS Online Training 150x Users
(135 paid users + 15 FREE)

SKU: H05005

GRIPPS eLearning Software Package 5
x Modules for external LMS use &
on-site leadership support

CUSTOM TRAINING SOLUTIONS

Need content to add to your existing training system? GRIPPS training material is available to purchase ready to add to your own platform - .mp4 / SCORM / HTML our team can help.

Alternatively, let us help create new bespoke content in collaboration with your company. We can deliver professional material to suit your specific industry or company needs.

Get in touch today to learn more!

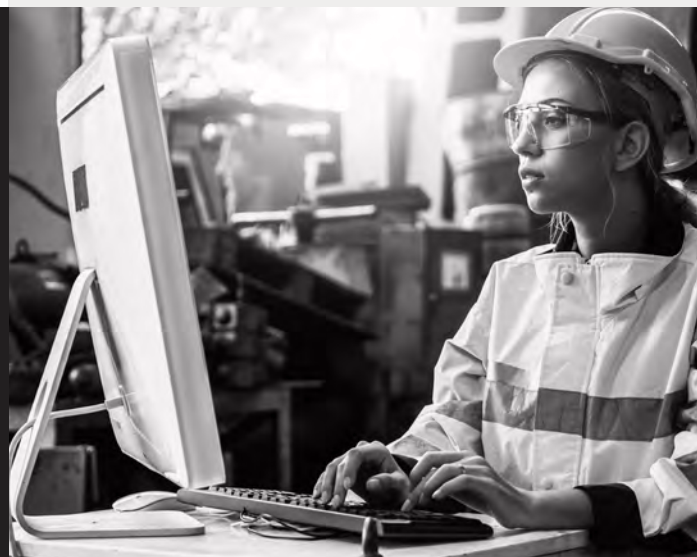

ONLINE

LEARNING OUTCOMES:

- **FALLING OBJECTS RISK AWARENESS**
- **THE CATT METHODOLOGY**
- **RISK ASSESSMENT & HIERARCHY OF CONTROLS**
- **THE RANGE CORRECT USE**
- **WORKING SAFELY WITH TOOLS AT HEIGHT**



FACE-TO-FACE

TRAINING COURSE OUTLINE:

MODULE 1 DROPPED OBJECT RISK AWARENESS

Learn how deadly an impact even the smallest of tools can create when being dropped at height. Demonstrating the immense, the immediate and long-term effects of dropped objects, this module is an eye-opener for industrial workers.

MODULE 2 DROPPED OBJECT RISK ASSESSMENT AND THE HIERARCHY OF CONTROLS

In this module, we will uncover what makes up the Hierarchy of Controls and how these controls impact you as a worker.

MODULE 3 WORKING WITH TOOLS AT HEIGHT

Discover what can cause drops, what to be aware of when tethering tools and learn about best practices when working at height.

MODULE 4 TOOL TETHERING USING CATT

In this module, we introduce the GRIPPS CATT methodology. You'll discover why this process is simple and effective for tool tethering correctly.

MODULE 5 THE GRIPPS RANGE & CORRECT USE

Learn how GRIPPS world-class tool tethering equipment is put to use correctly. It's one thing to have tool tethering equipment, but it MUST be used correctly. Discover the wide range of options available for different scenarios and various sizes of tools.

CATT TETHER PROCESS

The GRIPPS CATT method, is an acronym for remembering a highly effective system to safe tool tethering. The acronym is short for **CONNECT, ANCHOR, TETHER and TRANSPORT**.

It is important to not only buy the correct and safe equipment for you or your workers, but also ensure that everybody working at height understands the 'how to' for implementing best practice drop prevention. Widely recognised, the CATT system can be used by any worker as a means of approaching tool tethering.

C

CONNECT

Attach a Connection point to your tool that has the correct load rating, is suited to the task at hand and your work environment.

A

ANCHOR

Identify the Anchor point that you will be securing back to that is suited to the weight of your tool. This will be to the height workers person ie a load-rated, work belt, wrist attachment or tool bag, or the structure / equipment that is in use, if a suitable anchorage point is available.

T

TETHER

Select a tether that has a suitable load rating, length and is suited to the task at hand.

T

TRANSPORT

Identify how your tools and equipment will be transported around your project. Remember, almost a third of tool drops occur while tools are being carried between work areas! Certified tool bags and pouches are essential for eliminating dropped tool incidents on site.



ARE YOU DUE FOR A DROPS AUDIT?

The GRIPPS® on-site audit is a critical part of risk assessment for works at height, allowing you to address any blind-spots before they become incidents.

Our certified auditors will travel to your worksite and assess all operations at height, providing a comprehensive report identifying risks and solutions.

Enquire about GRIPPS audits, which will provide a professional and thorough external resource for your team.

If you are interested email:
sales@grippsglobal.com



The first step in a successful Dropped Object Prevention Strategy is building awareness around the risks associated with working at height.

Whether it's a toolbox talk, lunchroom presentation or live dropped object demonstration, we can help you drive awareness and change habits.

Leave a lasting impression with a keynote address from dropped object survivor and brand ambassador Paul Weatherson, who intimately discusses the human cost of a dropped object incident.

If you are interested email:
sales@grippsglobal.com

REQUEST AN ONSITE WORKSHOP

WHAT IS THE ANSI/ISEA 121-2018 STANDARD?

The ANSI/ISEA 121-2018 standard outlines prerequisites for 'minimum design, performance, and labelling requirements for solutions that reduce dropped objects incidents in industrial and occupational settings.'

The U.S. national standard ANSI/ISEA 121-2018 was written by the International Safety Equipment Association (ISEA), an ANSI-accredited standards developing organization. The American National Standards Institute (ANSI) is responsible for the management of standards and conformity assessment activities in the United States.

When it comes to working at heights, using products that meet the ANSI/ISEA 121-2018 standard will help provide a greater degree of trust in product performance, than those without this standard. At GRIPPS, wherever possible, we recommend to choose products that comply with this widely recognised standard.

The standard provides minimum requirements related to anchor attachments, tool attachments, tool tethers and containers used to prevent dropped objects in the workplace.

References:

- <https://www.ansi.org/>
- <https://isea.safetysystem.com/external/wcpages/wcecommerce/eComItemDetailsPage.aspx?ItemID=1>
- <https://blog.ansi.org/2019/03/standard-dropped-object-prevention-solutions>
- https://webstore.ansi.org/preview-pages/ISEA/preview_ANSI+ISEA+121-2018.pdf

**REMEMBER...
WHERE POSSIBLE,
ALWAYS CHOOSE AN
ANSI/ISEA 121-2018
COMPLIANT SOLUTION
TO PROTECT YOU
& YOUR WORKERS.**



BUILD DROP PREVENTION AWARENESS WITH THESE FREE ASSETS

DOWNLOAD AT GRIPPS.COM
OR EMAIL SALES@GRIPPSGLOBAL.COM



POSTERS



CATT METHOD

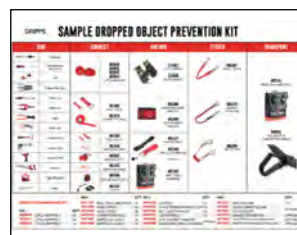

KIT BREAKDOWNS



CATALOGUES



AWARENESS PACKS



TOOL TETHER GUIDE

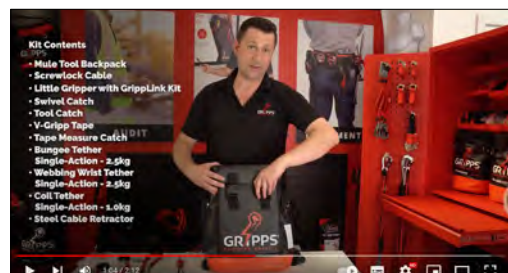

VIDEOS

GRIPPS provide a comprehensive range of resources to support drop prevention and tool tethering initiatives. Our suite of posters, videos, catalogues and guides are ideal for running your own safety campaigns in the workplace. All our products are designed with safety in mind and can be used as part of an effective tool tethering and drop prevention strategy to help reduce the risk of dropped tools and injuries.



CATT
TOOL
CONNECTORS

GRIPPS®

TOOL CONNECTORS

TOOL RING



*Tool not included

KEY FEATURES

- Quick, easy installation with no special tools or equipment required.
- Long lasting and economical.
- Available in three sizes.

MAX LOAD	SIZES	QTY	CODE
1.0 kg 2.0 lbs	19 mm 0.75"	10	H01036
1.0 kg 2.0 lbs	25 mm 1.0"	10	H01037
1.0 kg 2.0 lbs	38 mm 1.5"	10	H01038

SCREWLOCK CABLE

ANSI/ISEA 121-2018
COMPLIANT



*Tool not included

KEY FEATURES

- Easy screwlock attachment process that can be performed on-site.
- Long lasting PU coated aircraft-grade steel cable.
- It can be locked permanently using thread locking compounds.

MAX LOAD	SIZES	QTY	CODE
1.0 kg 2.2 lbs	3.0 mm x 120 mm 0.1" x 4.75"	1	H01030
		5	H01030-5
		10	H01030-10
1.0 kg 2.2 lbs	3.0 mm x 150 mm 0.1" x 6.0"	1	H01031
		5	H01031-5
		10	H01031-10
2.0 kg 4.4 lbs	4.0 mm x 160 mm 0.15" x 6.25"	1	H01032
		5	H01032-5
		10	H01032-10
2.0 kg 4.4 lbs	4mm x 200mm 0.15" x 7.87"	1	H01033
		5	H01033-5
		10	H01033-10

GRIPLOCK CABLE

ANSI/ISEA 121-2018
COMPLIANT



PATENT PENDING



*Tool not included

KEY FEATURES

- Simply press Griplock end connectors together to create a permanent attachment point.
- Suited to many styles of hand tools.
- Long lasting PU coated aircraft-grade steel cable.
- Creates a permanent tool connection point in moments.

MAX LOAD	SIZES	QTY	CODE
1 kg 2.2 lbs	3.0 mm x 12 cm 0.11" x 4.72"	1	H01040
		5	H01040-5
		10	H01040-10
1 kg 2.2 lbs	3.0 mm x 15 cm 0.11" x 5.9"	1	H01041
		5	H01041-5
		10	H01041-10

TOOL CONNECTORS

TOOL CATCH



KEY FEATURES

- Robust nylon connector with welded D-Ring.
- Suited to a vast array of hand tools.
- Fully certified & load-rated when used with V-Gripp Tape.

MAX LOAD	SIZES	QTY	CODE
1 kg 2.2 lbs	12mm x 55mm 0.47" x 2.1"	1	H01005
		5	H01005-5
		10	H01005-10
2.5 kg 5.5 lbs	25mm x 90mm 0.98" x 3.5"	1	H01006
		5	H01006-5
		10	H01006-10

TOOL CATCH – NON CONDUCTIVE



KEY FEATURES

- Robust nylon connector with poly D-Ring
- Easy installation process that can be done on-site.
- Ideal for use with non-conductive tools.
- Fully certified and load-rated when used with V-Gripp Tape.

MAX LOAD	SIZES	QTY	CODE
1.0 kg 2.2 lbs	12 mm x 55 mm 0.5" x 2.25"	1	H01007
1.0 kg 2.2 lbs	12 mm x 55 mm 0.5" x 2.25"	10	H01007-10

V-GRIPP TAPE



KEY FEATURES

- Self-fusing tape that provides a load-rated tool connection point when used with GRIPPS Tool Catch's and Tool Hitch's.
- Heat resistant to 150°C/302°F.
- Resistant to water & oil.
- Extremely resilient and long-lasting.

WIDTH	LENGTH	CODE
25mm 1.0"	2.7m 106"	H01010

V-GRIPP TAPE & TOOL CATCH KIT



KEY FEATURES

- Self-vulcanizing - no chemical adhesives.
- Heat resistant to 150°C/302°F.
- Resistant to water & oil.
- Extremely resilient and long-lasting.

MAX LOAD	KIT	CODE
2.5 kg 5.5 lbs	3x H01005, 3x H01006, 1xH01010	H01417

TOOL CONNECTORS

GRIPP SHRINK



*Tool not included

KEY FEATURES

- Provides additional protection for V-Gripp Tape.
- Quickly shrinks & protects when exposed to heat.
- Extremely resistant to abrasives.

SIZE	QTY	CODE
19 mm x 45 mm 0.75" x 1.75"	25	H03000
25 mm x 45 mm 1.0" x 1.75"	25	H03001
38 mm x 51 mm 1.5" x 2.0"	25	H03002
76 mm x 100 mm 3.0" x 4.0"	10	H03005

SWIVEL CATCH

ANSI/ISEA 121-2018
COMPLIANT



*Tool not included

KEY FEATURES

- Connects to tools with an existing hang-hole or slot.
- The steel connector ring includes a swivel point, providing a full 360-degree range of movement.

MAX LOAD	LENGTH	QTY	CODE
2.5 kg 5.0 lbs	13 cm 5.0"	1	H01021
		5	H01021-5
		10	H01021-10

TOOL-HITCH 16KG | 35LBS

ANSI/ISEA 121-2018
COMPLIANT



*Tool not included

KEY FEATURES

- Chokes around the enclosed handle of tools weighing up to 16kg/35lbs.
- Fast and simple application to tools with an enclosed area.
- No need for additional adhesives or equipment.
- Tactical grade Nylon for maximum strength.

MAX LOAD	CODE
16 kg 35 lbs	H01055

SINGLE ARM TOOL-HITCH 16KG | 35LBS

ANSI/ISEA 121-2018
COMPLIANT



*Tool not included

KEY FEATURES

- Chokes around the handle of larger tools weighing up to 16kg/35lbs.
- Ideally suited to power tools with a trigger on the handle.
- V-Gripp tape is used to secure the 'single arm' in way that doesn't interfere with the tool trigger.
- Tactical grade Nylon for maximum strength.

MAX LOAD	CODE
16 kg 35 lbs	H01056

TOOL CONNECTORS

DUAL ARM TOOL-HITCH 16KG | 35LBS

ANSI/ISEA 121-2018
COMPLIANT



*Tool not included.

KEY FEATURES

- Creates a load-rated tool connection point for heavy 'open' tools.
- Tactical grade Nylon for maximum strength.
- Heavy-duty closed metal D-Ring.

MAX LOAD	CODE
16 kg 35 lbs	H01057

HEAVY DUTY TOOL-HITCH - 36KG | 79LBS



*Tool not included.

KEY FEATURES

- Creates a load-rated tool connection point for heavy 'open' tools up to 36kg/79lbs.
- Tactical grade Nylon for maximum strength.
- Heavy-duty closed metal D-Ring.

MAX LOAD	CODE
36 kg 79 lbs	H01058

PHONE & TABLET GRIPPER

ANSI/ISEA 121-2018
COMPLIANT



H02039

*Phone not included.



H02039P



H02037

*Tablet not included.



H02037P

Now you can tether your tablet or mobile device without the need for a permanent or semi-permanent connection point. Used in conjunction with a load-rated tether, the Phone & Tablet Gripper uses purpose built silicon to create a load-rated tethering solution with zero impact on device operation.

KEY FEATURES

- Custom silicon compound made for strength & grip.
- Avoids installing a permanent connector point on a mobile & tablet device.
- No additional adhesives required.
- Integrated, load-rated tether connection eyelet.
- Compatible with every smart phone and tablet model.

PRODUCT NAME	MAX LOAD	SIZE	CODE
Phone Gripper	0.3 kg 0.66 lbs	Min. Phone Size: 135 mm x 65 mm x 7 mm	H02039
Phone Gripper with Coil Tether (Non-Conductive)		Max. Phone Size: 160 mm x 80 mm x 10 mm	H02039P
Tablet Gripper	0.85 kg 1.9 lbs	245 mm x 180 mm x 10 mm	H02037
Tablet Gripper with Coil Tether Single Action 1kg			H02037P

TOOL CONNECTORS

LITTLE GRIPPER KIT

ANSI/ISEA 121-2018
COMPLIANT



KEY FEATURES

- Simple press-fit installation onto the shaft of screwdrivers, allen keys etc.
- No additional adhesives or tools required for application.
- UV protected for long-lasting outdoor use.
- Compatible with tool shafts of many shapes & thickness.
- Made in Australia.

QTY	NAME	TOOL SHAFT DIAMETER	MAX TETHER LENGTH	MAX LOAD	CODE
2	Little Gripper	3.5 mm – 6.0 mm 0.1" - 0.2"	25 cm 10"	0.5 kg 1.0 lbs	H03048
2	Little Gripper	5.5 mm – 9.0 mm 0.2" - 0.3"			
2	Little Gripper	8.0 mm – 13 mm 0.3" - 0.5"			
2	Little Gripper	12 mm – 16 mm 0.5" - 0.6"			
4	Griplink	10mm / 17 mm 0.3" - 0.6"			

E-CATCH

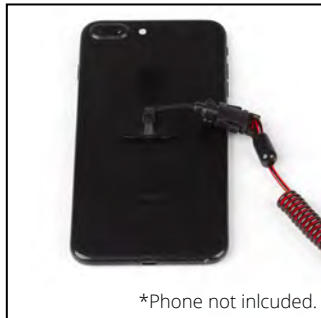

*Phone not included.

KEY FEATURES

- Adheres to phones, radios and electronic equipment.
- Ready to use immediately after application. Cures completely in 24 hours.
- Flexible, notched surface adheres to curved surfaces.
- Features heavy-duty industrial-grade VHB adhesive tape.
- Connects to the GRIPPS® Electronic Tool Tether.

MAX LOAD	CODE
0.5kg 1.0lbs	H01035
0.5kg 1.0lbs	H01035-10

BOLT GRIPPER



*Tool not included.

KEY FEATURES

- Secures M30 to M36 bolts.
- World-first product for steelworkers.
- Slides over nut and bolt, when the nut is threaded to bolt.
- Lightweight Aluminium.
- Manufactured in the UK.

SIZE	WEIGHT	CODE
19 cm (Aluminium Frame)	0.76 kg / 168 lbs	H02041
28 cm (Including Frame)		



CATT
GLOVES &
WRISTBANDS

GRIPPS®

EUROPEAN GLOVE STANDARDS

EN388:2016

The European standard DIN EN 388 outlines prerequisites for labelling of safety gloves against mechanical risks when carrying out work. This standard outlines the testing methods that must be performed and passed correctly before gloves can be sold within Europe. Largely recognised globally as an integral standard for comparing gloves and understanding practicality of a pair of gloves for different working situations.

The stresses tested for this standard include resistance to abrasion, blade cut resistance, tear resistance, puncture resistance, cut resistance (TDM test ISO 13997) and Impact Test. The diagram below outlines, what each number part of the standard symbol indicates and the scale of ratings.

EN 388:2016

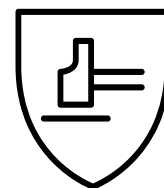

4542CX

TEST	RATING
Abrasion	1-4
Cut (Coup Test)	1-5
Tear	1-4
Puncture	1-4
Cut (TDM-100 Test)	A-F
Impact Protection	P,F,X

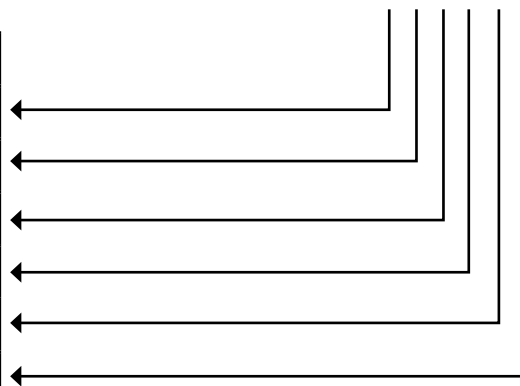

With the first four stresses listed above, the higher the number, the better the rating meaning, more resistance to abrasion, a higher level of cut protection or stronger material. For the Cut test, the further along the alphabet, the better the rating, with F the highest level. If a glove has an impact protection, this information is given by the letter P (Pass). If pertaining to F, the item failed. If the gloves showcase X, then the glove has not yet been tested.

AS/NZS 2161.3:2020 AUSTRALIAN + NEW ZEALAND STANDARD

Within Australia and New Zealand, the current testing standard equivalent to EN388 is the AS/NZS 2161.3:2020 standard - Occupational protective gloves Protection against mechanical risks. However, both EN388 and ANSI 105 are widely recognised internationally and within Australia/New Zealand.

AMERICAN GLOVE STANDARDS

ANSI 105-2016

The American National Standard For Hand Protection ANSI 105-2016, classifies and ranges gloves related to mechanical protection. This standard includes its own unique properties and markings, different to the european EN 388 system, but is equally treated as another major global standards for gloves.





Like the EN 388 standard, gloves tested against the ANSI 105-2016 standard also receive tests for abrasion resistance, cut resistance and puncture resistance.

OLD CUT LEVELS VS NEW

The newest ANSI 105-2016 standard ranks gloves on cut level testing scale from A1 (being lowest grade) to A9 (the highest grade). This system has replaced the former cut level ratings scale of C1 to C5. The new system scaling from $\geq 200\text{g}$ to $\geq 6000\text{g}$. The former Cut Level 5, now equates to A5 of the new standards, which situates as a cut level considered as Medium-High and is suitable for many industrial work applications.



ANSI 105-2016 CUT RATING GUIDE:

 ANSI/ASTM CUT LEVEL A1 ≥ 200g	 ANSI/ASTM CUT LEVEL A2 ≥ 500g	 ANSI/ASTM CUT LEVEL A3 ≥ 1,000g	 ANSI/ASTM CUT LEVEL A4 ≥ 1,500g	 ANSI/ASTM CUT LEVEL A5 ≥ 2,200g	 ANSI/ASTM CUT LEVEL A6 ≥ 3,000g	 ANSI/ASTM CUT LEVEL A7 ≥ 4,000g	 ANSI/ASTM CUT LEVEL A8 ≥ 5,000g	 ANSI/ASTM CUT LEVEL A9 ≥ 6,000g
LOW			MEDIUM-HIGH RANGE			EXTREME		

PREMIUM ENVIRONMENTAL HEIGHT SAFETY GLOVES

If you're looking for a glove that offers exceptional hand protection, comfort and dexterity, look no further than GRIPPS 'C5 Eco' and 'C5 Eco Impact'.

These gloves are **made from recycled plastics** and provide world-first anchor points so users can tether small hand tools whilst working at height. **Compliant with ANSI-ISEA 121-2018** standard and with a C5 cut rating, these gloves are also incredibly comfortable to wear. Blending innovative design with durable materials, the GRIPPS C5 Eco and C5 Eco Impact provide resistance to lacerations, added grip and a sound solution for drop prevention for small hand tools.

These gloves are also **carbon neutral certified**, with every pair being offset thanks to our partnership with the *Low Carbon Economy*.



REDUCE YOUR EMISSIONS. CARBON NEUTRAL. RECYCLED.



EVERY PAIR IS MADE
FROM 1X RECYCLED
PLASTIC BOTTLE!

*SKU S21628 & S21627 Gloves



S21625

C5 FlexiLite MKII



S21626

C5 FlexiLite Impact MKII



S21627

C5 Eco



S21628

C5 Eco Impact

WORLD FIRST TETHER READY GLOVES

Leaders in drop prevention, GRIPPS were the first to market with innovative industrial safety gloves, which include in-built anchor points for tool tethering. This adds greater flexibility and major convenience for those working at heights operating with small hand tools.

GRIPPS glove range boasts many great features listed below. For further information about samples and options, contact GRIPPS directly or your nearest distributor. For a list of distributors, visit grippsglobal.com/pages/store-locator

KEY FEATURES:

- ✓ **IN-BUILT TETHER ANCHOR**
- ✓ **ANSI A5 CUT RATED**
- ✓ **EXCEPTIONAL COMFORT**
- ✓ **SUPERIOR DEXTERITY**
- ✓ **DURABLE FINISH**
- ✓ **ANSI-ISEA 121 2018 COMPLIANT**

GLOVES & WRIST BANDS

C5 FLEXILITE MKII



ANSI/ISEA 121-2018 COMPLIANT



*Tool not included

PATENT PENDING



KEY FEATURES

- Improved flexibility & overall user comfort.
- Super lightweight HPPE knit liner providing maximum cut resistance.
- Double coated sandy foam nitrile for long-lasting grip.
- A load-rated tether anchor everywhere you go.
- Maintain full usability of tools.
- Compatible with the full range of GRIPPS® wrist tethers, SKU: H01060 and H01067.

MAX LOAD	EN STANDARD	CUT LEVEL RATING	ANSI RATING	SIZES	CODE
2.3 kg 5.5 lbs	EN 388: 2016 4542C	5	105 A3	S, M, L, XL, 2XL	S21625

C5 FLEXILITE IMPACT MKII



ANSI/ISEA 121-2018 COMPLIANT



*Tool not included

PATENT PENDING



KEY FEATURES

- Extra lightweight and highly flexible glass fibre yarn provides
- Double coated sandy foam nitrile for long-lasting grip.
- Ultra Armour TPR Rear protection against impact on backs of the hands.
- Load-rated and certified tool tether point.
- Compatible with the full range of GRIPPS® wrist tethers, SKU: H01060 and H01067.

MAX LOAD	EN STANDARD	CUT LEVEL RATING	ANSI RATING	SIZES	CODE
2.3 kg 5.5 lbs	EN 388: 2016 4542CP	5	105 A3	S, M, L, XL, 2XL	S21626

C5 ECO GLOVE



ANSI/ISEA 121-2018 COMPLIANT



*Tool not included

PATENT PENDING



KEY FEATURES

- Carbon Neutral Product Certified by the Carbon Reduction Institute
- Manufactured using recycled plastic bottles
- C5 Cut Rated & ANSI A5 rated - made of highly flexible glass fibre yarn, for maximum cut resistance
- Reinforced Thumb croch for extra protection
- Load-rated & certified tool tether point.
- Compatible with the full range of GRIPPS® wrist tethers, SKU: H01060 and H01067.

MAX LOAD	EN STANDARD	CUT LEVEL RATING	ANSI RATING	SIZES	CODE
2.3 kg 5.0 lbs	EN 388: 2016 4543E	5	105 A5	S, M, L, XL, 2XL	S21627

GLOVES & WRIST BANDS

C5 ECO IMPACT GLOVE



ANSI/ISEA 121-2018 COMPLIANT



*Tool not included

PATENT PENDING



KEY FEATURES

- Carbon Neutral Product Certified by the Carbon Reduction Institute
 - Impact padding & puncture protection
 - Manufactured using recycled plastic bottles
 - Certified and load-rated tool tether point
 - C5 Cut Rated - made of highly flexible glass fibre yarn.
 - Ultra-Armour TPR Rear protection
- Compatible with the full range of GRIPPS® wrist tethers, SKU: H01060 and H01067.

MAX LOAD	EN STANDARD	CUT LEVEL RATING	ANSI RATING	SIZES	CODE
2.3 kg 5.0lbs	EN 388: 2016 4X43EP	5	A5	S, M, L, XL, 2XL	S21628

SLIP-ON WRIST ANCHOR

ANSI/ISEA 121-2018 COMPLIANT



*Tool not included

KEY FEATURES

- Light, flexible & long lasting.
- Suitable for full range of GRIPPS® wrist tethers.
- Allows user to exit hand quickly if required.
- Built-in load-rated tether anchor point.

MAX LOAD	SIZE	CODE	QTY	CODE
2.5 kg 5.5 lbs	S	H01085-S	10 packs	H01085-S-10
	M	H01085-M		H01085-M-10
	L	H01085-L		H01085-L-10

KIT OPTION	MAX LOAD	SIZE	CODE
Slip-On Wrist Anchor with Tool Tether	2.5 kg 5.5 lbs	S	H01087-S
		M	H01087-M
		L	H01087-L

ADJUSTABLE WRIST-ANCHOR

ANSI/ISEA 121-2018 COMPLIANT



*Tool not included

KEY FEATURES

- Light, flexible & long lasting
- Can be attached to hand-rails or your wrist.
- Industrial grade Velcro adjusts diameter to suit any wrist size.
- Compatible with the full range of GRIPPS® wrist tethers.

MAX LOAD	SIZE	CODE	QTY	CODE
2.5 kg 5.5 lbs	One Size Fits All	H01086	10 packs	H01086-10

KIT OPTION	CODE
1 x Adjustable Wrist Anchor	H01088
1 x Webbing Wrist Tether Single-Action	



CATT
TOOL
TETHERS

GRIPPS®

TETHERS

BUNGEE TETHER DUAL-ACTION 7KG | 15LBS

ANSI/ISEA 121-2018
COMPLIANT



KEY FEATURES

- Swivel dual-action carabiner to enable full tool movement
- Heavy-duty elasticised webbing.
- Force absorption & bounce-back protection.
- Long lasting paracord tail loop that connects to tool or anchor point. Lightweight & compact design.

MAX LOAD	MIN. LENGTH	MAX. LENGTH	QTY	CODE
7.0 kg 15 lbs	89 cm 35"	1.3 m 50"	1	H01073
			10	H01073-10

BUNGEE TETHER DUAL CARABINER DUAL-ACTION 7KG | 15LBS

ANSI/ISEA 121-2018
COMPLIANT



KEY FEATURES

- Two dual-action carabiners with swivel heads.
- Long lasting, lightweight & compact design.
- Heavy-duty elasticised webbing.
- Force absorption & bounce-back protection.

MAX LOAD	MIN. LENGTH	MAX. LENGTH	CODE
7.0 kg 15 lbs	89 cm 35"	1.3 m 50"	H01073D

BUNGEE TETHER SINGLE-ACTION 2.5KG | 5.5LBS



KEY FEATURES

- Steel single-action carabiner.
- Lightweight & compact design.
- Heavy-duty elasticised webbing.
- Paracord tail loop that connects to tool or anchor point.
- Force absorption & bounce-back protection.

MAX LOAD	MIN. LENGTH	MAX. LENGTH	QTY	CODE
2.5 kg 5.5 lbs	89 cm 35"	1.3 m 50"	1	H01072
			10	H01072-10

BUNGEE TETHER TRIPLE-ACTION 7KG | 15LBS

ANSI/ISEA 121-2018
COMPLIANT



KEY FEATURES

- Triple-action carabiner mounted on a swivel head.
- Long-lasting, lightweight & compact design.
- Heavy-duty elasticised webbing.
- Force absorption & bounce-back protection.
- Paracord tail loop that connects to tool or anchor point.

MAX LOAD	MIN. LENGTH	MAX. LENGTH	QTY	CODE
7.0 kg 15 lbs	89 cm 35"	1.3 m 51"	1	H01074
			10	H01074-10

TETHERS

BUNGEE TETHER HEAVY-DUTY DUAL-ACTION 18KG | 40LBS

ANSI/ISEA 121-2018
COMPLIANT



*Tool not included

KEY FEATURES

- Heavy-duty dual-action carabiner.
- Long-lasting, lightweight & compact design.
- Heavy-duty elasticised webbing.
- Wide tail loop with additional grip-weave.
- Force absorption & bounce-back protection.

MAX LOAD	MIN. LENGTH	MAX. LENGTH	CODE
18.0 kg 40 lbs	89 cm 35"	1.3 m 50"	H01071

WEBBING TETHER HEAVY-DUTY DUAL-ACTION 15.9KG | 35LBS

ANSI/ISEA 121-2018
COMPLIANT



*Tool not included

KEY FEATURES

- Heavy duty dual-action carabiner.
- Extra heavy-duty webbing.
- Ideal for securing large tools & equipment at height.
- Extended reach allows tether anchor-point flexibility.
- Wide tail loop with additional grip-weave.

MAX LOAD	LENGTH	CODE
15.9 kg 35 lbs	1.8 m 71"	H01076

WEBBING TETHER EXTRA HEAVY-DUTY DUAL-ACTION 36.9KG | 81LBS

ANSI/ISEA 121-2018
COMPLIANT



KEY FEATURES

- Two heavy-duty dual-action carabiners.
- Extra-large dual-action carabiner for attaching to suitable handrails and scaffolding.
- Extra heavy duty abrasion-resistant webbing.
- Long-lasting, lightweight design.
- Extended reach allows for tether anchor-point flexibility.

MAX LOAD	LENGTH	CODE
36.9 kg 81 lbs	1.8 m 71"	H01079



TETHERS

COIL TETHER DUAL-ACTION 2.3KG | 5LBS

ANSI/ISEA 121-2018
COMPLIANT



KEY FEATURES

- Two lightweight dual-action swivel carabiners.
- Minimal 'free-hanging' length reduces the possibility of getting snagged when in use.
- Extra thick PU coated stainless steel coil.
- Heat & cut resistant.

MAX LOAD	MIN. LENGTH	MAX. LENGTH	QTY	CODE
2.3 kg 5.0 lbs	50 cm 20"	1.7 m 67"	1	H01069
			5	H01069-5

COIL TETHER SINGLE-ACTION 1.0KG | 2.2LBS



KEY FEATURES

- Two lightweight single-action swivel carabiners.
- Suitable for holsters, belts, pouches & harnesses.
- Low profile & lightweight design.
- Extra thick PU coated stainless steel coil.
- Heat & cut resistant.

MAX LOAD	MIN. LENGTH	MAX. LENGTH	QTY	CODE
1.0 kg 2.2 lbs	40 cm 15"	1.6 m 63"	1	H01068
			5	H01068-5

COIL TETHER SINGLE-ACTION (NON-CONDUCTIVE) 1.0 KG | 2.2LBS

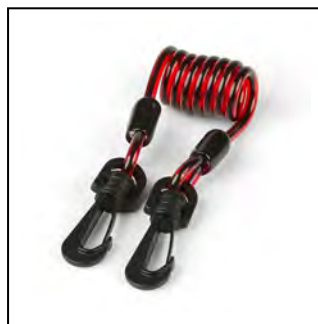

KEY FEATURES

- Two lightweight single-action swivel poly clips.
- Low profile & lightweight design.
- Suitable for working in live electrical environments.

MAX LOAD	MIN. LENGTH	MAX. LENGTH	QTY	CODE
1.0 kg 2.2 lbs	17 cm 7.0"	77 cm 30"	1	H01062
			10	H01062-10

WEBBING WRIST TETHER DUAL-ACTION 2.5KG | 5.5LBS

ANSI/ISEA 121-2018
COMPLIANT

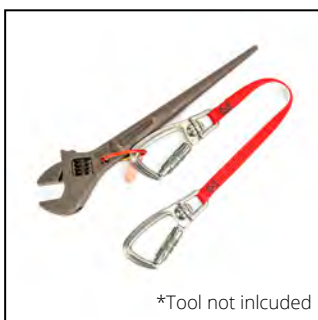

KEY FEATURES

- Two heavy-duty dual-action carabiners.
- Abrasion-resistant webbing.
- Long-lasting & lightweight design.

MAX LOAD	LENGTH	QTY	CODE
2.5 kg 5.5 lbs	25 cm 10"	1	H01060
		10	H01060-10

TETHERS

WEBBING WRIST TETHER SINGLE-ACTION 2.5KG | 5.5LBS



*Glove/Tool not included

KEY FEATURES

- Two swivel-action carabiners.
- Abrasion-resistant webbing.
- Ideal for use with GRIPPS Gloves and Wristbands.
- Long-lasting and lightweight

MAX LOAD	LENGTH	QTY	CODE
2.5 kg 5.5 lbs	25 cm 10"	1	H01067
		10	H01067-10

WEBBING TOOL TETHER/SHOULDER STRAP - 5KG | 11LBS

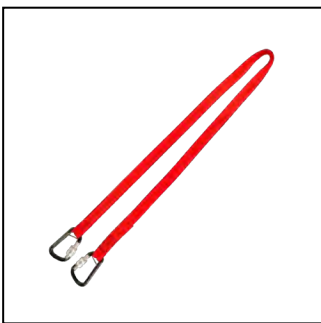

*Bag not included

KEY FEATURES

- Two dual-action screw-lock carabiners.
- Abrasion-resistant webbing.
- Long-lasting & lightweight design.

MAX LOAD	MIN LENGTH	MAX LENGTH	CODE
5.0 kg 11 lbs	105 CM 41"	170 cm 67"	H01077

COIL HARD HAT TETHER



ANSI/ISEA 121-2018
COMPLIANT



*Hat not included

KEY FEATURES

- Lightweight & low profile design.
- Extremely strong metal clamp.
- Industrial grade PU coil.

MAX LOAD	MIN. LENGTH	MAX. LENGTH	QTY	CODE
0.5 kg 1.0 lbs	11 cm 4.0"	86 cm 34"	1	H01070
			10	H01070-10

COIL HARD HAT TETHER (NON-CONDUCTIVE)



ANSI/ISEA 121-2018
COMPLIANT



*Hat not included

KEY FEATURES

- Non-conductive design.
- Lightweight and low profile design.
- Extremely strong poly clamp.
- Industrial grade PU coil.

MAX LOAD	MIN. LENGTH	MAX. LENGTH	QTY	CODE
0.5 kg 1.0 lbs	11 cm 4.0"	86 cm 34"	1	H01075
			10	H01075-10



GRIPPS
CONCRETE GRABBER

OXGRIP

OXGRIP

GRIPPS

GRIPPS®

TETHERS

COIL E-TETHER WITH POLY CLIP & E-CATCH (NON-CONDUCTIVE)



KEY FEATURES

- Heavy-duty poly clip.
- Industrial grade PU coil.
- Non-conductive design.
- Compatible with the GRIPPS® E-Catch.

PRODUCT NAME	MAX LOAD	MIN. LENGTH	MAX. LENGTH	QTY	CODE
Coil E-Tether with Poly Clip	0.5 kg 1.0 lbs	18 cm 7.0"	86 cm 34"	1	H01063
				10	H01063-10
Coil E-Tether with Poly Clip & E-Catch	0.5 kg 1.0 lbs	18 cm 7.0"	86 cm 34"	1	H01061
				10	H01061-10

COIL E-TETHER WITH STEEL CLAMP & E-CATCH

ANSI/ISEA 121-2018 COMPLIANT



KEY FEATURES

- Heavy-duty steel clamp.
- Industrial grade PU coil.
- Low profile & lightweight.
- Compatible with the GRIPPS® E-Catch.

PRODUCT NAME	MAX LOAD	MIN. LENGTH	MAX. LENGTH	QTY	CODE
Coil E-Tether with Steel Clamp	0.5 kg 1.0 lbs	18 cm 7.0"	86 cm 34"	1	H01066
				10	H01066-10
Coil E-Tether with Steel Clamp & E-Catch	0.5 kg 1.0 lbs	18 cm 7.0"	86 cm 34"	1	H01064
				10	H01064-10

COIL E-TETHER WITH POLY CLAMP & E-CATCH (NON-CONDUCTIVE)

ANSI/ISEA 121-2018 COMPLIANT



KEY FEATURES

- Heavy-duty poly clamp.
- Industrial grade PU coil.
- Low profile & lightweight.
- Compatible with the GRIPPS® E-Catch.

PRODUCT NAME	MAX LOAD	MIN. LENGTH	MAX. LENGTH	QTY	CODE
Coil E-Tether with Poly Clamp	0.5 kg 1.0 lbs	18 cm 7.0"	86 cm 34"	1	H01065
				10	H01065-10
Coil E-Tether with Poly Clamp & E-Catch	0.5 kg 1.0 lbs	18 cm 7.0"	86 cm 34"	1	H01059
				10	H01059-10

TETHERS

COIL E-TETHER WITH DUAL LOCKING CARABINER & E-CATCH



KEY FEATURES

- Heavy-duty poly clip.
- Industrial grade PU coil.
- Dual locking carabiner.
- Compatible with the GRIPPS® E-Catch.

PRODUCT NAME	MAX LOAD	MIN. LENGTH	MAX. LENGTH	QTY	CODE
Coil E-Tether w/ Dual Locking Carabiner	0.5 kg 1.0 lbs	18 cm 7.0"	120 cm 47"	1	H01054
				10	H01054-10
Coil E-Tether w/ Dual Locking Carabiner & E-catch	0.5 kg 1.0 lbs	18 cm 7.0"	120 cm 47"	1	H01053
				10	H01053-10

GEAR KEEPER RETRACTABLE TOOL TETHER WITH LOCK

ANSI/ISEA 121-2018 COMPLIANT



KEY FEATURES

- Stainless steel dual-action carabiner.
- Locking retractor functionality.
- Buckle clip to instantly swap out tools.
- Includes retractor unit & 1 x Gear Keeper Tool Tether Connector.

PRODUCT NAME	MAX LOAD	MAX. LENGTH	CODE
Gear Keeper Retractable Tether with Lock 0.45 kg	0.45 kg 1.0 lb	1.5 m 59"	H01128
Gear Keeper Retractable Tether with Lock 0.9 kg	0.9 kg 2.0 lbs		H01127

GEAR KEEPER TOOL TETHER CONNECTOR

ANSI/ISEA 121-2018 COMPLIANT



KEY FEATURES

- Shock absorbing Nylon cord.
- Buckle clip to instantly swap out tools.
- Available in two different sizes.
- Made in the USA.

PRODUCT NAME	MAX LOAD	MAX. LENGTH	QTY	CODE
Gear Keeper Tool Tether Connector 0.45 KG	0.45 kg 1.0 lb	1.5 m 59"	10	H01126
Gear Keeper Tool Tether Connector 0.9 KG	0.9 kg 2.0 lbs		10	H01129

TETHERS

TOOL GRAPPLE® WITH AUTO-STOP



*Tool not included

KEY FEATURES

- 1.25m / 49" auto-retracting wire cable tether.
- Rubber ABS synthetic housing.
- PU coated stainless steel woven wire cable tether.
- Can be anchored to a harness, work belt or wrist-band.
- Auto-stopping function.

MAX LOAD	MAX. LENGTH	CODE
2.5 kg 5.5 lbs	1.25 m 49"	H01123

TOOL GRAPPLE® WITH DUAL LOCKING CARABINER



*Tool not included

KEY FEATURES

- 1.25m / 49" auto-retracting wire cable tether.
- Rubber ABS synthetic housing.
- PU coated stainless steel woven wire cable tether.
- Can be anchored to a harness, work belt or wrist band.

MAX LOAD	MAX. LENGTH	CODE
2.5 kg 5.5 lbs	1.25 m 49"	H01122-C

STEEL CABLE RETRACTOR UNIT



KEY FEATURES

- Designed for use in GRIPPS Tool Holsters and Tool Bags.
- Made with steel cable.
- Made in the USA.

MAX LOAD	MAX. LENGTH	CODE
0.7 kg 1.5 lbs	1.2 m 47"	H01120

KEVLAR CABLE RETRACTOR WITH AUTO-STOP



KEY FEATURES

- Designed for use in GRIPPS Tool Holsters and Tool Bags.
- Made with kevlar cable.
- Auto-stopping function.
- Made in the USA.

MAX LOAD	MAX. LENGTH	CODE
0.7 kg 1.5 lbs	1.2 m 47"	H01125

TETHERS

DUAL-ACTION CARABINER 2.5KG | 5.5LBS



KEY FEATURES

- Constructed from strong & lightweight alloy.
- Auto-locking dual-action.
- Strong, proven design.
- Swivel head to prevent tangles in tether.
- Deep-set gripping surface to prevent slippage.
- Open gate width of 13mm/0.5".

MAX LOAD	CODE
2.5 kg 5.5 lbs	H01093

SAFETY GLASSES TETHER



*Glasses not included

KEY FEATURES

- Premium quality PU-coated wire straps.
- Silicone rubber grips that securely hold all styles of safety glasses.
- Adjustable length.
- Load-rated.

MAX LOAD	LENGTH WHEN CLOSED	CODE
0.1kg 0.22 lbs	2.3 cm 0.9"	H10000





CATT

**BAGS &
POUCHES**

GRIPPS®

BAGS & POUCHES

MULE BAG 80KG | 176LBS



The champion of the GRIPPS® lifting bag range, the Mule Bag provides a broad range of transportation and work-site mounting options.

The tough design with multiple reinforcement points makes it one of the strongest lifting bags on the global market, purpose-built to operate and last in the harshest of workplace environments.

KEY FEATURES

- Width compatible with standard Ladder Cages.
- Reinforced backpack straps, EWP mounting straps & load-rated lifting points.
- Armoured insert for protection when wearing as a backpack.
- Load-rated heavy-tool sleeves on both sides of the bag.
- Tether anchor points inside & outside the bag for multiple tethering options.
- Multiple compartments inside the bag for tool storage & organisation.
- Zip lid closure for complete tool security.
- Rubber feet for base longevity.

MAX LOAD (D-RING)	MAX LOAD (LIFTING)	HEIGHT	WIDTH	DEPTH	CODE
3.0kg 6.6lbs	80kg 176lbs	45cm 18"	40cm 15.7"	21cm 8.0"	H01140

MULE TOOL BACKPACK 20KG | 44LBS



Based on the best-selling GRIPPS® Mule Bag, the Mule Tool Backpack provides all of the same key functionality in a smaller, more compact design.

This lightweight and versatile bag is constructed from PVC leather and nylon materials. Extremely durable, the Mule Tool Backpack features additional reinforced material at the base, to protect against punctures.

KEY FEATURES

- Lightweight, durable & robust design.
- Made from waterproof PVC leather and zip closures
- Reinforced, puncture-proof base.
- Fold-out front panel.
- Load-rated mounting straps for attaching to rails & scaffolding.
- Tool organisation sleeves, pockets & straps.
- Multiple internal & external load-rated anchor points.
- Ideal size when climbing ladders in restricted size areas.

MAX LOAD (D-RING)	MAX LOAD (LIFTING)	HEIGHT	WIDTH	DEPTH	CODE
3.0kg 6.6lbs	20kg 44lbs	42cm 16"	32cm 13"	10cm 3.9"	H01141

TRANSPORT & STORAGE

BISON BAG 45KG | 99LBS



Loaded with features, the Bison Bag provides a comprehensive solution to tool management, transportation and tethering for working at height.

Tether anchors inside and outside the bag keep tools secure and accessible, and an extra heavy-duty drawstring closure keeps contents secured against spills and drops.

Built for harsh industrial environments from extra heavy-duty 26oz. canvas, the Bison Bag protects against punctures with a composite insert built right into the base of the bucket.

A load-rated lifting strap allows for easy transportation of the Bison Bag to the work area. Available with option carabiner.



OPTIONAL CARABINER



KEY FEATURES

- Multiple inner pockets for comprehensive tool organisation.
- Puncture-proof composite insert in the bucket base.
- Tether anchor points on the inside & outside of the bucket.
- Constructed from extra heavy-duty 26oz canvas.

PRODUCT NAME	MAX LOAD (D-RING)	MAX LOAD (STRAP)	HEIGHT	DIAMETER	CODE
BISON BAG	2.5 kg 5.5 lbs	45 kg 100 lbs	40 cm 16"	30 cm 12"	H01115
BISON BAG WITH CARABINER	2.5 kg 5.5 lbs	45 kg 100 lbs	40 cm 16"	30 cm 12"	H01115-C



BAGS & POUCHES

BULL BAG - 113KG | 249LBS



*Tethers not included

KEY FEATURES

- Heavy-duty Velcro closure protects against accidental spills.
- Load-rated fabric strip provides an additional 6 tether anchor points.
- Rubber feet protect the base of the bag & provide stabilisation on hard surfaces.
- A reinforced rim around the bag opening protects against damage.
- A strong composite insert in the base of the bag protects against punctures.
- Made with extra heavy-duty oil-repellent vinyl & tested to last in the harshest of construction environments.
- Strong mesh sleeve allows light into the bag & keeps it rigid whilst upright.
- Built-in tether anchor points inside the bucket, enabling tools to be tethered directly to the inside of each bag.

MAX LOAD (D-RING)	MAX LOAD (LIFTING)	HEIGHT	DIAMETER	CODE
2.5 kg 5.5 lbs	113 kg 250 lbs	38 cm 15"	31 cm 12"	H01110

ZIP-LOCK BAG - 30KG | 66LBS



KEY FEATURES

- Puncture & water resistant.
- 10mm/0.4" heavy-duty Nylon zip lid closure..
- Reinforced lid and bottom.

MAX LOAD	HEIGHT	DIAMETER	CODE
30 kg 66 lbs	38 cm 15"	31 cm 12"	H01112

TRANSPORT & STORAGE

LOCKJAW CLIMBERS BAG 10KG | 22LBS

ANSI/ISEA 121-2018
COMPLIANT



KEY FEATURES

- Heavy-duty tether anchors installed inside & outside the bag.
- Heavy-duty zip closure for security against contents falling out.
- Metal snap mechanism holds bag open or snaps it shut.
- Inner pockets for tool organisation.

MAX LOAD (D-RING)	MAX LOAD (LIFTING)	HEIGHT	DIAMETER	CODE
2.5 kg 5.5 lbs	10 kg 22 lbs	30 cm 12"	20 cm 7.0"	H01135

LOCKJAW RIGGERS BAG 5KG | 11LBS



KEY FEATURES

- Heavy duty certified tool bag for small hand tools and fasteners.
- A metal snap opening that allows the bag to be locked open or closed.
- Industrial strength zip to totally secure contents.
- Inner sleeve tool organisation pockets, sleeves & pouches.
- A total of 10 load-rated D-Rings to anchor tethers to.
- Can be attached to work belts & harnesses in a variety of locations.

SIZE (WIDTH X HEIGHT X DEPTH)	MAX LOAD (D-RING)	MAX LOAD (POUCH)	CODE
23 cm x 26 cm x 10 cm 9.0" x 10" x 4.0"	2.5 kg 5.5 lbs	5.0 kg 11 lbs	H02106

LIFTING BAG INSERT

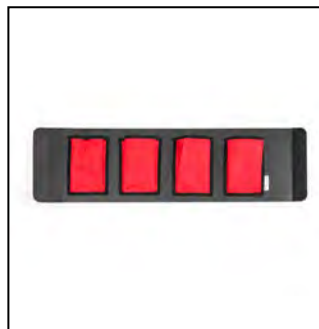

KEY FEATURES

- Instantly transform your GRIPPS® Lifting Bag into a workable tool bag with the GRIPPS® Lifting Bag Insert.
- Constructed from heavy-duty Nylon.
- 4 reinforced tool organisation pockets.
- Compatible with the following GRIPPS® lifting bags: H01110, H01115, H01112.

SIZE	DIAMETER RANGE	CODE
93 cm x 27 cm x 0.4 mm 37" x 11" x 0.15"	27 cm - 29 cm 10" - 11"	H01109

BAGS & POUCHES

SCAFFOLD TUBE LIFTING BAG 45KG | 100LBS



KEY FEATURES

- Lift & transport tubes up to 1.8m/71" in length.
- 6 load-rated D-Rings around bag opening.
- Puncture, chemical & temperature resistant Hypalon reinforced base.
- Constructed from 26oz. cotton canvas.
- Pull-string enclosure to fully secure contents.

MAX LOAD (D-RING)	MAX LOAD (LIFTING)	CODE
2.5 kg 5.0 lbs	45 kg 100 lbs	H01101

SEAL BAG 20KG | 44LBS



GRIPPS Seal Bags are heavy-duty, hard-wearing, waterproof gear bags designed for the most demanding of industrial work sites. Engineered utilising reinforced tarpaulin material and featuring detachable shoulder straps and water-resistant zips, these bags are ready for any work site. A solid duffel bag to add to your work gear collection.

KEY FEATURES

- Heavy-duty weatherproof PVC tarpaulin barrel bag
- 10 water-resistant zips
- Padded shoulder straps convert barrel bag to backpack
- Heavy-duty 2" webbing encircles the bag for extra strength
- End haul handles
- Twin QR compression strap

SIZE	MAX LOAD	VOLUME	CODE
60 cm x 35 cm x 35 cm 23.62" x 13.8" x 13.8"	20kg 44lbs	64 l 17 gal	H01102



TRANSPORT & STORAGE

GRIPPS TETHERING STATION (G.T.S.)

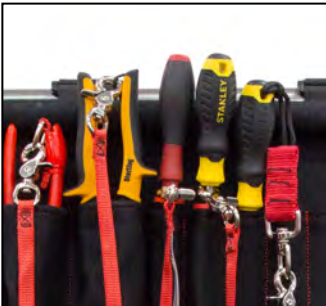
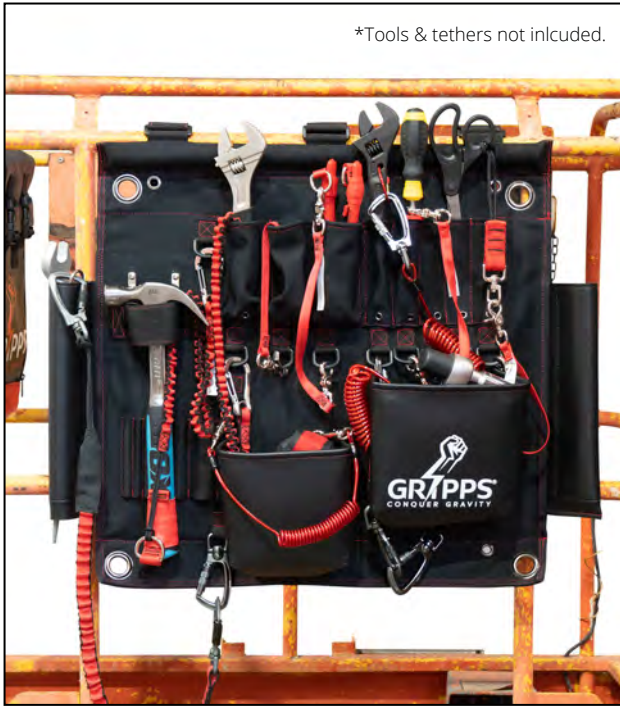

The GTS-20T GRIPPS® Tethering Station is a fully functional mobile tethering workstation suitable for 20x tools capacity and a range of environments. Constructed from an extra heavy-duty 26oz canvas.

For all works at height, attach the GTS to scaffold tubes, handrails or EWP cages using the load-rated and hard-wearing straps. Reinforced eyelets allow the GTS to be hung via hooks or tied off with rope to suit virtually any other conceivable environment.

Supported by a rigid backboard that prevents twisting or distortion, the GTS is loaded with options for a complete tool kit-out. Dual general-purpose pouches are reinforced with inner-stitched plating – perfect for battery tools. A range of stretch-webbing and canvas sheaths keep your full kit of hand-tools, heavy's and equipment organised and accessible.

KEY FEATURES

- Organises & tethers up to 20 tools.
- Mounting straps compatible with EWP cages, scaffold tubing, & handrails.
- Reinforced stiff backing creates a stable workstation.
- Extra heavy-duty 26oz. canvas.

MODEL	SIZE (WIDTH X HEIGHT X DEPTH)	MAX LOAD (D-RING)	CODE
20T	60cm x 55cm 24" x 22"	1.0 kg 2.2 lbs	H01147
Rain cover		NA	H01147-RC



BAGS & POUCHES

BOLT-VAULT 2.5KG | 5LBS



KEY FEATURES

- Enables nuts and bolts to be installed and removed inside the enclosed 'vault'.
- Constructed from heavy-duty Nylon.
- Front elastic weave panel allows the insertion of threaded objects
- Side elastic weave panel allows insertion of spanners/ wrenches.
- Two mesh side panels enable visibility inside the vault.

SIZE (WIDTH X HEIGHT X DEPTH)	MAX LOAD (D-RING)	MAX LOAD (POUCH)	CODE
11 cm x 25 cm x 13 cm 4.25" x 10" x 5.0"	2.5 kg 5.0 lbs	2.5 kg 5.0 lbs	H02105

BOLT-SAFE POUCH 5KG | 11LBS



KEY FEATURES

- Keeps objects such as nuts, bolts, screws, etc. securely enclosed.
- Fits easily onto most tool belts & can easily be fitted to harnesses & rails using the Velcro strap.
- Canvas material that repels oil & is easy to wipe clean.
- Reach-in retrieval & automatic self-closure means no more lids or zips.

SIZE (WIDTH X HEIGHT X DEPTH)	MAX LOAD (D-RING)	MAX LOAD (POUCH)	CODE
22 cm x 26 cm x 9 cm 8.5" x 10" x 3.5"	2.5 kg 5.0 lbs	5.0 kg 11 lbs	H02101

BOLT-SAFE RAIL BAG 5KG | 11LBS

ANSI/ISEA 121-2018
COMPLIANT



KEY FEATURES

- Keeps small objects such as nuts, bolts, screws etc. securely enclosed.
- Attaches easily to tool belts, harnesses & rails.
- Made from tough canvas that repels oil & is easy to wipe clean.
- Reach-in retrieval and automatic self-closure means no more lids or zips.
- Reinforced mesh window allows light inside the pouch.

SIZE (WIDTH X HEIGHT X DEPTH)	MAX LOAD (POUCH)	CODE
24 cm x 30 cm x 9 cm 9.5" x 12" x 3.5"	5.0 kg 11 lbs	H02102

TRANSPORT & STORAGE

SECURPULLEY WITH FIXED MOUNT



KEY FEATURES

- Supplied with a fixed scaffold mounting arm
- Fully Load-rated
- Rapid installation process
- Lightweight & user friendly
- Made in Italy

MAX LOAD	Permitted Rope Diameter	CODE
50 kg 110 lbs	20 mm 0.79"	M06020

SWIVEL MOUNTING ARM



KEY FEATURES

- Rapid installation process
- Easily fitted to standard scaffold tube
- Inbuilt quick release lock
- Made in Italy

MAX LOAD	CODE
50 kg 110 lbs	M06021





TOOL CONNECTOR PACKS

GRIPPS®

TOOL CONNECTOR PACKS

NIPS - 1KG/2.2LB SOLID TOOL CONNECTOR PACK FOR TOOL BELT

ANSI/ISEA 121-2018
COMPLIANT



*Tool not included

Nips can now be securely connected to your tool belt with this convenient bundle, which features GRIPPS V-Gripp Tape, a Tool Catch, GRIPP Shrink and a Swivel Catch. The Swivel Catch works to prevent tangles when working with hand tools at height.

KIT CONTENTS	CODE
0.1 x V Gripp Tape	H07003
0.1 x Gripp Shrink 25mm x 50mm	
1 x Tool Catch 12mm x 55mm	
1 x Swivel Catch 130mm	

HAMMER - 2.5KG/5.5LB SOLID HANDLE CONNECTOR PACK FOR TOOL BELT

ANSI/ISEA 121-2018
COMPLIANT



*Tool not included

Get all the connectors you require for adding any hammer to your tool belt with this pack. Including unique self-vulcanizing GRIPPS V-Gripp Tape (which is resistant to heat, water, and oil), a Tool Catch, and GRIPP Shrink, no hammer is a challenge.

Once applied to your hammer, you can use the existing GRIPPS H01073 cable to connect between your belt and your new hammer Tool Catch.

Note - The max load of your hammer can be up to 2.5KG/5.5LBS

KIT CONTENTS	CODE
1 x V Gripp Tape	H07000
1 x Tool Catch	
1 x GRIPP Shrink 51mm x 76mm	

MEASURING TAPE CONNECTOR PACK FOR TOOL BELT

ANSI/ISEA 121-2018
COMPLIANT



*Tool not included

GRIPPS Measuring Tape Connection Pack for Tool Belt includes the essentials items needed to add a tape measure to your work belt. The GRIPPS Tape Measure Catch which permits quick and easy removal/storage of a Tape Measure. The included GRIPPS Swivel Catch (130mm), helps prevent tangles when working with hand tools at height and reduces tension found when directly attaching a tool to a retractor.

Note - the max load of your tool cannot exceed .7kg or 1.5lbs when connected to a GRIPPS retractor.

KIT CONTENTS	CODE
1 x Tape Measure Catch	H07005
1 x GRIPP Shrink 51mm x 76mm	

TOOL CONNECTOR PACKS

SCAFFOLD KEY & LEVEL CONNECTOR PACK FOR TOOL BELT

ANSI/ISEA 121-2018 COMPLIANT



*Tool not included

Whether you need to support a scaffold key or a spirit level, this pack includes the GRIPPS Swivel Catch 130mm, which works to prevent tangles when working with hand tools at height. Easily loop your Swivel Catch through the hole/opening of your scaffold key or spirit level and connect with your existing belt retractor.

Note - the max load of your tool cannot exceed .7kg or 1.5lbs when connected to a GRIPPS retractor

KIT CONTENTS	CODE
1 x Swivel Catch 130mm	H07006

RATCHET/WRENCH - 1KG/2.2LB OPEN TOOL CONNECTOR PACK FOR TOOL BELT

ANSI/ISEA 121-2018 COMPLIANT



*Tool not included

Get all the connectors you require for adding a Ratchet or Wrench to your tool belt with ease. This bundle includes a changeable GRIPPS Screwlock Cable and Swivel Catch. The Swivel Catch works to prevent tangles when working with hand tools at height and permits 360-degree operational range of motion.

Note - The max load of your tool can be up to 2.5KG/5.5LBS

KIT CONTENTS	CODE
1 x Screwlock Cable 120 mm	H07001
1 x Swivel Catch 130mm	

2X TOOL OPEN CONNECTOR PACK

ANSI/ISEA 121-2018 COMPLIANT



*Tool not included

This tool connector pack will give you the flexibility to add any hand tools with an existing hole/opening to your work belt with ease. The Griplock Cables provided give a permanent connection point for your tools, whilst the additional GRIPPS Swivel Catch will provide added flexibility - as the bridge between your belt retractor and Griplock Cable.

Note - the max load of your tool cannot exceed .7kg or 1.5lbs, when connected to a GRIPPS retractor.

KIT CONTENTS	CODE
1 x Griplock Cable	H07007
1 x Swivel Catch 130mm	



TOOL BELTS & HOLSTERS

GRIPPS[®]

TOOL BELTS & HOLSTERS

COMFORT WORK BELT WITH BACK SUPPORT

ANSI/ISEA 121-2018
COMPLIANT



KEY FEATURES

- Allows for full customisation of holster & pouch layout.
- Multiple load-rated tether anchors for tether attachment.
- Engineered 'Ergo-Motion' back support for ultimate comfort.
- 'Ergo-Motion' design engineered to spread the weight of a loaded belt evenly on the user.
- Heavy-duty Cordura structure.

MAX LOAD (D-RING)	LENGTH	SIZE	CODE
2.5 kg 5.5 lbs	140cm 55"	One Size Fits All	H01116

ERGO-MOTION BACK SUPPORT

ANSI/ISEA 121-2018
COMPLIANT



KEY FEATURES

- 4x Suspender attachment points.
- Amazingly comfortable.
- Compatible with the GRIPPS® Reinforced Synthetic Work Belt & Econo Belt

MAX LOAD (D-RING)	LENGTH	SIZE	CODE
2.5 kg 5.5 lbs	130cm 51"	One Size Fits All	H01118

REINFORCED SYNTHETIC WORK BELT



KEY FEATURES

- Compatible with the Ergo-Motion Back Support.
- Heavy-duty Cordura structure.
- Reinforced with form-poly belt support.
- Dual pin belt buckle.
- 'Ergo-Motion' design for maximum comfort.

LENGTH	SIZE	CODE
140cm 55"	One Size Fits All	H01119

ECONO BELT



KEY FEATURES

- Ultra-lightweight and strong Nylon belt.
- Adjustable to any length with Velcro inlay.
- Heavy-duty buckle.

MAX LOAD	SIZE	CODE
15 kg 33 lbs	One Size Fits All	H01114

TOOL BELTS & HOLSTERS

LEATHER WORK BELT

ANSI/ISEA 121-2018
COMPLIANT



KEY FEATURES

- Genuine Leather
- Double-prong buckle for extra strength
- Available in three sizes: Small, Medium, and Large
- Lightweight and comfortable

SIZE	CODE
SMALL	H01117-S
MEDIUM	H01117-M
LARGE	H01117-L

BELT-LOOP ANCHOR

ANSI/ISEA 121-2018
COMPLIANT



*Belt not included.

KEY FEATURES

- Welded D-Ring.
- Made from abrasion-resistant webbing.
- Compatible with all standard work belt sizes.

MAX LOAD	QTY	CODE
2.5 kg 5.5 lbs	1	H01142
	10	H01142-10

BOA HOLSTER

ANSI/ISEA 121-2018
COMPLIANT



*Belt not included.

KEY FEATURES

- Ideal for holding a vast array of battery tools secure on a work belt.
- Made from industrial-strength, lightweight plastic.
- Spring loaded mechanism immediately traps battery operated hand tools in the holster.
- Compatible with virtually any work belt.

MAX LOAD	SIZE	CODE
5.0 kg 11 lbs	One Size Fits All	H02031

CLAW HAMMER HOLSTER

ANSI/ISEA 121-2018
COMPLIANT

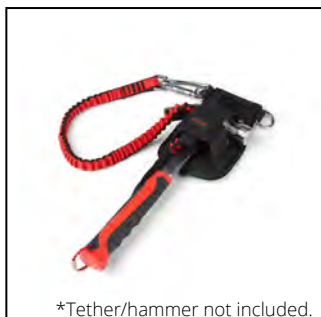

*Tether/hammer not included.

KEY FEATURES

- Compatible with all standard work belts.
- Snap-lock button to secure the hammer in the holster.
- 2 x load-rated D-Rings.
- Lightweight design with industrial toughness.

MAX LOAD	CODE
2.5 kg 5.0 lbs	H02062

TOOL BELTS & HOLSTERS

SCAFFOLD KEY HOLSTER



*Scaffold Key & Swivel Catch not included.

KEY FEATURES

- Compatible with all standard work belts.
- 2 x load-rated D-Rings.
- Lightweight design with industrial toughness.
- Compatible with GRIPPS® Retractor Units.

PRODUCT NAME	MAX LOAD (D-RING)	MAX LOAD (RETRACTOR)	MAX LENGTH	CODE
Scaffold Key Holster	2.5 kg 5.5 lbs	NA	1.2 m 47"	H02047
Retractable Scaffold Key Holster	2.5 kg 5.5 lbs	0.7 kg 1.5 lbs	1.2 m 47"	H02049

RATCHET/WRENCH HOLSTER MKII



H02090



*Ratchet/Swivel Catch not included.



H02091

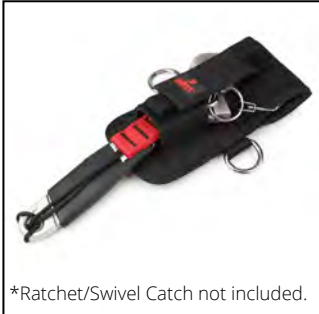

*Ratchet/Swivel Catch not included.

Engineered to carry a wide range of ratchets and wrenches, the Ratchet/Wrench Holster makes transporting and using your tools a breeze when working at height.

This holster also includes the option for a horizontal-release retractor unit.

KEY FEATURES

- Compatible with all standard work belts.
- 2 x load-rated D-Rings.
- Drain hole.
- Lightweight design with industrial toughness.
- Compatible with GRIPPS® Retractor Units.

PRODUCT NAME	MAX LOAD (D-RING)	MAX LOAD (RETRACTOR)	MAX LENGTH	CODE
Ratchet/Wrench Holster MKII	2.5 kg 5.5 lbs	N/A	1.2 m 47"	H02090
Retractable Ratchet/Wrench Holster MKII		0.7 kg 1.5 lbs		H02091



GRIPPS®

TOOL BELTS & HOLSTERS

SINGLE TOOL HOLSTER MKII



KEY FEATURES

- Compatible with all standard work belts.
- 2 x load-rated D-Rings.
- Drain hole.
- Lightweight design with industrial toughness.
- Compatible with GRIPPS® Retractor Units.

PRODUCT NAME	MAX LOAD (D-RING)	MAX LOAD (RETRACTOR)	MAX LENGTH	CODE
Single Tool Holster MKII		N/A		H02070
Retractable Single Tool Holster MKII	2.5 kg 5.5 lbs	0.7 kg 1.5 lbs	1.2 m 47"	H02071
Retractable Single Tool Holster with Auto-Stop MKII		0.7 kg 1.5 lbs		H02072

DUAL TOOL HOLSTER MKII



KEY FEATURES

- Compatible with all standard work belts.
- 2 x load-rated D-Rings.
- Drain hole.
- Lightweight design with industrial toughness.
- Compatible with GRIPPS® Retractor Units.

PRODUCT NAME	MAX LOAD (D-RING)	MAX LOAD (RETRACTOR)	MAX LENGTH	CODE
Dual Tool Holster MKII		NA		H02075
Retractable Dual Tool Holster MKII				H02076
Retractable Dual Tool Holster (Combo Retractors) MKII	2.5 kg 5.5 lbs	0.7 kg 1.5 lbs 0.7 kg 1.5 lbs	1.2 m 47"	H02077
Retractable Dual Tool Holster (Kevlar Retractors) MKII				H02078

TOOL BELTS & HOLSTERS

TAPE MEASURE HOLSTER MKII



KEY FEATURES

- Compatible with all standard work belts and standard tape measure sizes.
- 2 x load-rated D-Rings.
- Lightweight design with industrial toughness.
- Compatible with GRIPPS® Retractor Units.
- Drain Hole

PRODUCT NAME	MAX LOAD (D-RING)	MAX LOAD (RETRACTOR)	MAX LENGTH	CODE
Tape Measure Holster MKII		N/A		H02080
Retractable Tape Measure Holster MKII	2.5 kg 5.5 lbs	0.7 kg 1.5 lbs	1.2 m 47"	H02081

TAPE MEASURE LATCH



KEY FEATURES

- Compatible with the Tape Measure Catch.
- 2 x load-rated D-Rings.
- Lightweight design with industrial toughness.
- Compatible with GRIPPS® Retractor Units.

PRODUCT NAME	MAX LOAD (D-RING)	MAX LOAD (RETRACTOR)	MAX LENGTH	CODE
Tape Measure Latch		N/A		H02057
Retractable Tape Measure Latch	2.5 kg 5.0 lbs	0.7 kg 1.5 lbs	1.2 m 47"	H02058

TAPE MEASURE CATCH



KEY FEATURES

- Can be worn on or off a work belt.
- Compatible with the GRIPPS® Tape Measure Latch & Tape Measure Holster.
- Compatible with virtually all tape measure brands and sizes from 5 m - 8 m/16.5' - 26'.
- Maintains full tape measure functionality while secured.

MAX LOAD	CODE
0.7 kg 1.5 lbs	H02056

KIT OPTION	CODE
1 x Retractable Tape Measure Latch	H02059
1 x Tape Measure Catch	
1 x Swivel Catch	

TOOL BELTS & HOLSTERS

ADJUSTABLE TWO-WAY RADIO HOLSTER



Compatible with virtually every Two-Way Radio on the market, the Adjustable Radio Holster is also compatible with other small electronic devices such as phones and cameras.

Easily mounted to either work belts or harnesses, the Adjustable Radio Holster uses a two-way Velcro mounting sleeve to secure itself to the user.

Use in conjunction with a GRIPPS® Coil E-Tether With E-Catch.

KEY FEATURES

- Compatible with all standard work belts.
- Fully adjustable to be compatible with virtually all Two-Way Radios.
- Suitable for use with all small electronic devices such as phones & cameras.
- Easily mountable to work belts or harnesses via a two-way Velcro mounting sleeve.

MAX LOAD	CODE
0.5 kg 1.1 lbs	H02034

KIT OPTION	CODE
1 x Two-Way Radio Holster	H02035
1 x Non-Conductive Coil E-Tether With Poly Clip	
1 x E-Catch	

MONITOR/RADMAN HOLSTER



KEY FEATURES

- Compatible with a wide range of monitors including RadMan's.
- Easily mountable to work belts or harnesses via a two-way Velcro mounting sleeve.
- Compatible with the GRIPPS® Coil E-Tether With Poly Clip.

MAX LOAD	CODE
0.5 kg 1.1 lbs	H02036

WATER BOTTLE INSULATED STAINLESS STEEL



KEY FEATURES

- Load-rated Attachment Point Built-in
- Double-wall vacuum insulated
- Made from Stainless Steel
- Powder-coated Exterior
- Convenient flip-up sipper
- 750ml Volume

MAX LOAD	CODE
5 kg 11 lbs	H02020

TOOL BELTS & HOLSTERS

WATERBOY

ANSI/ISEA 121-2018
COMPLIANT



*Tether not included.



KEY FEATURES

- Insulated synthetic rubber design that can stretch to accommodate most sizes of bottles & cans.
- Full functionality of spray cans & screw/pop-top water bottles whilst in the holster.

MAX LOAD	CODE
0.75 kg 1.6 lbs	H02038

WATERBOY XL



*Tether not included.

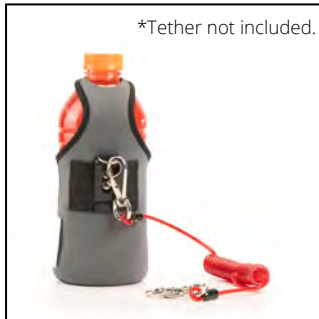

KEY FEATURES

- Insulated synthetic rubber design that can stretch to accommodate most sizes of bottles & cans (up to 2 Litre!)
- Full functionality of spray cans & screw/pop-top water bottles whilst in the holster.
- Built-in slide-on-style belt clip
- In-built anchor point for securing the holster to your belt

MAX LOAD	CODE
2 kg 4.4 lbs	H02021



TOOL BELTS & HOLSTERS

BATTERY CATCH HOLSTER

ANSI/ISEA 121-2018
COMPLIANT



KEY FEATURES

- Tethers your power tool & battery in a singular holster.
- Compatible with virtually all power tool brand batteries.
- Ability to remove & plug battery into power tools whilst inside the holster.
- Tough reinforced Nylon housing for Long-term durability.
- No impact on power tool usability.

MAX LOAD	CODE
4.5 kg 10 lbs	H02032

*Tool not included.



*Battery not included.



GRIPPS
CONQUER GRAVITY

TRADE KITS

GRIPPSTM
CONQUER GRAVITY

GRIPPS[®]

TRADE KITS

THE DROP BOX



A true turn-key solution, The Drop Box provides 100% support for your work-site dropped tool prevention policy and ensures that all of your site workers have ready access to a comprehensive range of drop tool prevention equipment.

Tether up to 300 tools/devices with a huge array of flexible connection, tether and anchoring options.

On-site training in use and best practices included.

KEY FEATURES

- Industrial duty 0.6mm x 1.0mm/0.02" x 0.04" steel construction.
- Lockable keyed doors with 3 locking points.
- Sliding draw and fixed height workbench.
- Pegboard panel for hooks.
- Louvred panel for plastic tubs.
- Quality durable powder coat finish.

HEIGHT	WIDTH	DEPTH	CODE
1.85 m 73"	1.0 m 39"	56c m 22"	H01409



KIT CONTENTS

Qty	SKU	Product Name	Qty	SKU	Product Name
1	H04005	Tool Cabinet with Storage Compartment	3	H01110	Bull Bag - 113.0KG
20	H01073	Bungee Tether Dual-Action 7KG	1	H01147	GRIPPS Tethering Station - 20T 1.0KG
3	H01076	Webbing Tether Heavy Duty 15.9KG	5	H02075	Dual Tool Holster MKII
3	H01071	Bungee Heavy-Duty Tether 18 kg	3	H02101	Bolt Safe Pouch
6	H01079	Webbing Tether Extra Heavy Duty Dual-Action - 36.9kg	2	H02106	Lockjaw Riggers Bag
10	H01069	Coil Tether Dual-Action - 2.3kg	30	H01030	Screwlock Cable 120mm
20	H01086	Adjustable Wrist-Anchor	30	H01031	Screwlock Cable 150mm
20	H01021	Swivel Catch 130mm	10	H01032	Screwlock Cable 160mm
20	H01142	Belt-Loop Anchor	10	H01033	Screwlock Cable 200mm
30	H01006	Tool Catch 25mm x 90mm	5	H03048	Little Gripper Kit
30	H01005	Tool Catch 12mm x 55mm	20	H01066	Coil E-Tether With Steel Clamp
6	H01010	V-Gripp Tape	20	H01035	E-Catch
10	H01055	Tool-Hitch 16.0KG	20	H01067	Webbing Wrist Tether Single-Action 2.5 KG
10	H01056	Single Arm Tool-Hitch 16.0KG	20	H01070	Coil Hard Hat Tether
10	H01057	Dual Arm Tool-Hitch 16.0KG	12	S21626-L	C5-Impact Technique With Tool Tether Size: L
2	H01058	Heavy-Duty Tool-Hitch 36.0KG	12	S21626-XL	C5 FlexiLite Impact MKII Glove - XL
10	H02035	Adjustable Two-Way Radio Holster w/Coil E-Tether & E-Catch	3	HS-3010	"DROP ZONE" Barrier Tape
6	H01123	Tool Grapple with Auto-Stop	3	HS-E02000	Bunting Safety Flags on Rope
10	H02039P	Phone Gripper with Coil Tether (Non-Conductive)	1	HS-4010	"TOOL TETHERS MUST BE USED" Mandatory Sign 450mm x 600mm
10	H02056	Tape Measure Catch	1	HS-4011	"TOOL TETHERS MUST BE USED" Mandatory Sign 300mm W x 450mm
10	H02038	Waterboy	1	HS-4012	"TOOL TETHERS MUST BE USED" Mandatory Sign 225mm W x 300mm
3	H02032	Battery Catch Holster	1	H05050	GRIPPS Tether Guide Pack
2	H01114	Econo Belt			

TRADE KITS

THE DROP STORE



Representing over 25 years of collaboration and innovation alongside industries that work at height, The Drop Store is your total turn-key solution for the management of this critical risk.

Contains over 840 individual components that cater for up to 50 height workers.

Certified training in dropped object prevention and best practices for 5 people included.

KEY FEATURES

- Industrial duty 0.6mm x 1.0mm/0.02" x 0.04" steel construction.
- Lockable keyed doors with 3 locking points.
- Sliding draw and fixed height workbench.
- Training included.

HEIGHT	WIDTH	DEPTH	CODE
1.85 m 73"	1.0 m 39"	56 cm 22"	H01408

KIT CONTENTS

Qty	SKU	Product Name	Qty	SKU	Product Name
1	H04005	Tool Cabinet with Storage Compartment	3	H01307	Modular Drop Mat
1	H05000	Target Zero Drops- Certified Training Course 1/2 Day	5	H02075	Dual Tool Holster MKII
40	H01073	Bungee Tether Dual-Action - 7.0KG	50	H01030	Screwlock Cable 120mm
6	H01079	Webbing Tether Extra Heavy Duty Dual-Action - 36.9kg	50	H01031	Screwlock Cable 150mm
5	H01076	Webbing Tether Heavy Duty - 15.9KG	10	H02101	Bolt Safe Pouch
10	H01071	Bungee Heavy-Duty Tether - 18 kg	5	H03048	Little Gripper Kit
10	H01069	Coil Tether Dual-Action - 2.3kg	4	H01037-10	Tool Rings 25mm (10 Pack)
30	H01086	Adjustable Wrist-Anchor	4	H01038-10	Tool Rings 38mm (10 Pack)
30	H01021	Swivel Catch 130mm	3	H01070-10	Coil Hard Hat Tether (10 Pack)
100	H01006	Tool Catch 25mm x 90mm	1	H01061-10	Coil E-Tether with Poly Clip & E-Catch (Non-Conductive) (10 Pack)
100	H01005	Tool Catch 12mm x 55mm	1	H01059-10	Coil E-Tether with Poly Clamp & E-Catch (Non-Conductive) (10 Pack)
20	H01055	Tool-Hitch -16.0KG	1	H01064-10	Coil E-Tether with Steel Clamp & E-Catch (10 Pack)
20	H01056	Single Arm Tool-Hitch 16.0KG	1	H01053-10	Coil E-Tether with Dual Locking Carabiner & E-Catch (Non-Conductive) (10 Pack)
20	H01057	Dual Arm Tool-Hitch 16.0KG	2	H01068-5	Coil Tether Single-Action 1.0KG
10	H01058	Heavy-Duty Tool-Hitch 36KG	2	H02106	Lockjaw Riggers Bag
1	H02035	Adjustable Two-Way Radio Holster w/Coil E-Tether & E-Catch	15	H10000	Safety Glasses Tether
10	H01123	Tool Grapple with Auto-Stop	2	H02037P	Tablet Gripper with Coil Tether Single-Action 1.0KG
30	H02039P	Phone Gripper with Coil Tether (Non-Conductive)	30	H01067	Webbing Wrist Tether Single-Action - 2.5KG
20	H02056	Tape Measure Catch	12	S21628-L	C5 Eco Impact Glove - L
20	H01010	V-Gripp Tape	12	S21628-XL	C5 Eco Impact Glove - XL
4	H03001	Gripp Shrink 25mm x 50mm (25 Pack)	1	HS-4010	"TOOL TETHERS MUST BE USED" Mandatory Sign 450mm (W) x 600mm (H)
4	H03002	Gripp Shrink 38mm x 51mm (25 Pack)			
20	H02038	Waterboy	1	HS-4011	"TOOL TETHERS MUST BE USED" Mandatory Sign 300mm (W) x 450mm (H)
10	H02032	Battery Catch Holster			
50	H01142	Belt-Loop Anchor	1	HS-4012	"TOOL TETHERS MUST BE USED" Mandatory Sign 225mm (W) x 300mm (H)
3	H01110	Bull Bag - 113.0KG			
1	H01147	GRIPPS Tethering Station - 20T - 1.0KG	1	H05050	GRIPPS Tether Guide Pack

TRADE KITS

CRANE CREW KIT



Designed in collaboration with Crane Erectors and Maintenance Crews, this kit enables all tools used in the erection and maintenance of cranes to be tethered and stored securely at all times.

KIT CONTENTS				CODE: H01422	
Qty	SKU	Product Name	Qty	SKU	Product Name
2	H01010	V-Gripp Tape	1	H01071	Bungee Heavy-Duty Tether Dual-Action 18KG
10	H01005	Tool Catch - 12mm x 55mm	1	H01079	Webbing Tether Extra Heavy Duty Dual-Action - 36.9kg
10	H01006	Tool Catch - 25mm x 90mm	2	H01068	Coil Tether Single-Action - 1.0kg
2	H01057	Dual Arm Tool-Hitch - 16KG	1	H01085-M	Slip-On Wrist Anchor - Size M
10	H01030	Screwlock Cable - 3mm x 120mm	1	H01067	Webbing Wrist Tether Single-Action - 2.5KG
10	H01031	Screwlock Cable - 3mm x 150mm	1	S21626-L	C5 FlexiLite Impact MKII Glove - L
1	H01036	Tool Ring - 19mm (10 Pack)	1	H02101	Bolt-Safe Pouch
1	H01037	Tool Ring - 25mm (10 Pack)	1	H02106	Lockjaw Riggers Bag
1	H01038	Tool Ring - 38mm (10 Pack)	1	H01114	Econo Belt
3	H03048	Little Gripper Kit	1	H01110	Bull Bag - 113KG
10	H01021	Swivel Catch	1	H02039P	Phone Gripper with Coil Tether
2	H01073	Bungee Tether Dual-Action - 7KG	1	H01077	Webbing Tool Tether/Shoulder Strap - 5KG

RIGGERS TRADE KIT



This trade kit contains a selection of Tool Connectors, Anchors & Tethers suitable for the full range of Riggers tools, including Podgers, Ratchets and more. Flexible anchoring options allow you to tether tools to either the belt or wrist.

Tethers up to 20 tools.

KIT CONTENTS				CODE
Qty	SKU	Product Name		
2	H01073	Bungee Tether Dual-Action 7KG	H01410	
10	H01005	Tool Catch - 12mm x 55mm		
1	H01085-M	Slip-On Wrist Anchor - Size M		
1	H01010	V-Gripp Tape		
1	H01067	Webbing Wrist Tether Single-Action - 2.5KG		
2	H01142	Belt-Loop Anchor		
10	H01031	Screwlock Cable - 3mm x 150mm		

SCAFFOLDERS TRADE KIT



Explicitly designed for Scaffolders, this kit allows for the tethering of a Ratchet, Key, Level, Hammer and Tape Measure, to an existing tool belt.

Tethers up to 13 tools.

KIT CONTENTS				CODE
Qty	SKU	Product Name		
2	H01073	Bungee Tether Dual-Action 7KG	H01411	
2	H01068	Coil Tether Single-Action - 1KG		
1	H01021	Swivel Catch		
1	H01067	Webbing Wrist Tether Single-Action - 2.5KG		
1	H01085-M	Slip-On Wrist Anchor - Size M		
2	H01142	Belt-Loop Anchor		
1	H02056	Tape Measure Catch		
10	H01030	Screwlock Cable - 3mm x 120mm		

TRADE KITS

BOILERMAKER/WELDERS TRADE KIT



This selection of Tool Connectors, Anchors & Tethers, covers the suite of tools used by Boilermakers and Welders, including Hammers, Pliers, Wrenches, Spanners and more.

Flexible anchoring options allow you to tether tools to either the belt or wrist.

Tethers up to 31 tools.

KIT CONTENTS			
Qty	SKU	Product Name	CODE
1	H01142	Belt-Loop Anchor	H01412
2	H01069	Coil Tether Dual-Action - 2.3KG	
1	H01037	Tool Ring - 25mm (10 Pack)	
1	H02056	Tape Measure Catch	
10	H01005	Tool Catch - 12mm x 55mm	
1	H01010	V-Gripp Tape	
10	H01030	Screwlock Cable - 3mm x 120mm	

ELECTRICAL TRADE KIT



An end-to-end solution covering the entire suite of hand and power tools used by Electricians. Tethers up to 31 tools.

KIT CONTENTS			
Qty	SKU	Product Name	CODE
1	H02056	Tape Measure Catch	H01413
1	H01073	Bungee Tether Dual-Action 7KG	
1	H01068	Coil Tether Single-Action - 1KG	
1	H01021	Swivel Catch	
10	H01007	Tool Catch (Non-Conductive) - 12mm x 55mm	
1	H01010	V-Gripp Tape	
1	H01067	Webbing Wrist Tether Single-Action - 2.5KG	
1	H01062	Coil Wrist Tether Single-Action (Non-Conductive) - 2.5KG	
1	H01142	Belt-Loop Anchor	
1	H01085-M	Slip-On Wrist Anchor - Size M	
10	H01030	Screwlock Cable - 3mm x 120mm	
1	H03048	Little Gripper Kit	

MECHANICAL FITTERS TRADE KIT



Tether a full range of Power Tools, Spanners, Wrenches and other tools used by Mechanical Fitters, with anchoring options to the waist, wrist or external structures, e.g. rails. Tethers up to 36 tools.

KIT CONTENTS			
Qty	SKU	Product Name	CODE
1	H01037	Tool Ring - 25mm (10 Pack)	H01414
1	H01021	Swivel Catch	
10	H01005	Tool Catch - 12mm x 55mm	
1	H01010	V-Gripp Tape	
2	H01073	Bungee Tether Dual-Action 7KG	
1	H01068	Coil Tether Single-Action - 1KG	
1	H01142	Belt-Loop Anchor	
1	H01085-M	Slip-On Wrist Anchor - Size M	
1	H01067	Webbing Wrist Tether Single-Action - 2.5KG	
1	H02056	Tape Measure Catch	
10	H01030	Screwlock Cable - 3mm x 120mm	
1	H03048	Little Gripper Kit	

TRADE KITS

DIY ESSENTIALS KIT



Perfect for a small range of tools, or to protect yourself against drops when working on DIY projects.

Tethers up to 20 tools.

KIT CONTENTS			
Qty	SKU	Product Name	CODE
1	H01073	Bungee Tether Dual-Action 7KG	H01415
1	H01010	V-Gripp Tape	
10	H01005	Tool Catch - 12mm x 55mm	
10	H01030	Screwlock Cable - 3mm x 120mm	

MULE BAG KIT



Featuring the GRIPPS champion lifting tool bag, the Mule Bag kit provides a range of tool connector points to suit many tool types and tether anchor options. Tethers up to 25 tools.

KIT CONTENTS			
Qty	SKU	Product Name	CODE
10	H01005	Tool Catch - 12mm x 55mm	H01416
1	H01057	Dual Arm Tool-Hitch - 16KG	
1	H01073	Bungee Tether Dual-Action 7KG	
1	H01068	Coil Tether Single-Action - 1KG	
1	H01010	V-Gripp Tape	
1	H01085-M	Slip-On Wrist Anchor - Size M	
1	H01067	Webbing Wrist Tether Single-Action - 2.5KG	
1	H01140	Mule Bag - 80KG	
1	H01021	Swivel Catch	
10	H01030	Screwlock Cable - 3mm x 120mm	
1	H03048	Little Gripper Kit	
1	HS-4011	TOOL TETHERS MUST... Mandatory Sign - 300mm W x 450mm	

MULE TOOL CONQUER KIT



This kit includes GRIPPS popular Mule Tool Backpack, an impressive range of connectors and tethers that give you immense versatility for tethering different tools.

KIT CONTENTS				CODE: H01421	
Qty	SKU	Product Name	Qty	SKU	Product Name
1	H01141	Mule Tool Backpack - 20KG	1	H03048	Little Gripper Kit
1	H01030-10	Screwlock Cable - 3mm x 120mm (10 Pack)	1	H01021	Swivel Catch
1	H01005-10	Tool Catch - 12mm x 55mm (10 Pack)	1	H02056	Tape Measure Catch
1	H01010	V-Gripp Tape	1	H02039P	Phone Gripper with Coil Tether (Non-Conductive)
2	H01072	Bungee Tether Single-Action - 2.5KG	1	S21627-L	C5 Eco Glove - L
1	H01120	Steel Cable Retractor Unit - 0.7KG	1	H01067	Webbing Wrist Tether Single-Action - 2.5KG
1	H01125	Kevlar Cable Retractor Unit with-Auto Stop - 0.7KG			
2	H01068	Coil Tether Single-Action - 1KG			

TRADE KITS

TELCO KIT



For Telecommunication Riggers and Climbers, this kit enables the safe tethering, storage and transportation of all tools whilst working at height.

KIT CONTENTS			
Qty	SKU	Product Name	CODE
1	H01135	Lockjaw Climbers Bag - 10KG	H01419
1	H01086	Adjustable Wrist-Anchor	
1	H01060	Webbing Wrist Tether Dual-Action - 2.5KG	
2	H01074	Bungee Tether Triple-Action - 7KG	
10	H01005	Tool Catch - 12mm x 55mm	
1	H01010	V-Gripp Tape	
10	H01030	Screwlock Cable - 3mm x 120mm	
1	H01057	Dual Arm Tool-Hitch - 16KG	
1	H02036	Monitor/RadMan Holster	
1	H02039P	Phone Gripper with Coil Tether (Non-Conductive)	
1	H01077	Webbing Tool Tether/Shoulder Strap - 5KG	
1	H01061	Coil E-Tether With Poly Clip & E-Catch (Non-Conductive)	

FACADE WORKERS KIT



Hand-picked by Facade Installation Crews themselves, this kit allows Facade Workers to tether all of their tools, all the time. This kit also offers the flexibility to anchor the tools back to handrails, the wrist or waist.

Tethers up to 45 tools.

KIT CONTENTS			
Qty	SKU	Product Name	CODE
5	H01073	Bungee Tether Dual-Action 7KG	H01418
5	H01055	Tool Hitch - 16KG	
1	H01086	Adjustable Wrist-Anchor	
1	H01067	Webbing Wrist Tether Single-Action - 2.5KG	
2	H01010	V-Gripp Tape	
10	H01030	Screwlock Cable - 3mm x 120mm	
10	H01031	Screwlock Cable - 3mm x 150mm	
10	H01005	Tool Catch - 12mm x 55mm	
10	H01006	Tool Catch - 25mm x 90mm	

(M)EWP TOOL TETHER KIT



This kit is suitable for all works carried out while operating from a MEWP/EWP. A versatile range of Tool Connectors, Anchors and Tethers allows operators to tether all of their tools, and keep all equipment off the EWP floor.

KIT CONTENTS			
Qty	SKU	Product Name	CODE
1	H01073	Bungee Tether Dual-Action 7KG	H01420
1	H01079	Webbing Tether Extra Heavy Duty Dual-Action - 36.9KG	
1	H01085-M	Slip-On Wrist Anchor - Size M	
1	H01067	Webbing Wrist Tether Single-Action - 2.5KG	
1	H01010	V-Gripp Tape	
10	H01005	Tool Catch - 12mm x 55mm	
1	H01057	Dual Arm Tool-Hitch - 16KG	
10	H01030	Screwlock Cable - 3mm x 120mm	
1	H02102	Bolt-Safe Rail Bag	
1	H01147	Gripps Tethering Station - 20T	
1	H03048	Little Gripper Kit	
1	HS-4010	TOOL TETHERS MUST... Mandatory Sign - 450mm x 600mm	

TRADE KITS

ESSENTIALS 10 TOOL TETHER KIT



Designed to suit the budget conscious, this kit provides a range of tool connector points and tethers to suit a range of tool types and tether anchor options.

Tethers up to 25 tools.

KIT CONTENTS			
Qty	SKU	Product Name	CODE
1	H01073	Bungee Tether Dual-Action 7KG	H01401
1	H01068	Coil Tether Single-Action - 1KG	
1	H01085-M	Slip-On Wrist Anchor - Size M	
1	H01067	Webbing Wrist Tether Single-Action - 2.5KG	
1	H01010	V-Gripp Tape	
10	H01005	Tool Catch - 12mm x 55mm	
1	H01057	Dual Arm Tool-Hitch - 16KG	
10	H01031	Screwlock Cable - 3mm x 150mm	
1	H03048	Little Gripper Kit	

10 TOOL TETHER KIT WITH BULL BAG



The ideal kit for the worker with occasional at-height tasks. The range of tethers and tool connectors allow tethering of any tool in your kit, with the flexibility of anchoring to the wrist, a belt or the supplied lifting bag

Tethers up to 25 tools.

KIT CONTENTS			
Qty	SKU	Product Name	CODE
10	H01005	Tool Catch - 12mm x 55mm	H01400
1	H01057	Dual Arm Tool-Hitch - 16KG	
2	H01073	Bungee Tether Dual-Action 7KG	
1	H01010	V-Gripp Tape	
1	H01085-M	Slip-On Wrist Anchor - Size M	
1	H01067	Webbing Wrist Tether Single-Action - 2.5KG	
1	H01110	Bull Bag - 113KG	
10	H01031	Screwlock Cable - 3mm x 150mm	
1	H03048	Little Gripper Kit	

40 TOOL TETHER KIT WITH BULL BAG & BOLT-SAFE POUCH



This all-rounder kit provides a comprehensive range of options to safely tether hand tools when working at height. Featuring components drawn from most areas of the GRIPPS® drop-prevention system, this kit makes an excellent addition to many tool kits.

KIT CONTENTS				CODE: H01403	
Qty	SKU	Product Name	Qty	SKU	Product Name
10	H01005	Tool Catch - 12mm x 55mm	1	H01063	Coil E-Tether With Poly Clip (Non-Conductive)
10	H01006	Tool Catch - 25mm x 90mm	1	H01035	E-Catch
1	H01057	Dual Arm Tool-Hitch - 16KG	1	H02101	Bolt-Safe Pouch
10	H01021	Swivel Catch	3	H01037	Tool Ring - 25mm (10 Pack)
3	H01073	Bungee Tether Dual-Action 7KG	10	H01031	Screwlock Cable - 3mm x 150mm
1	H01069	Coil Tether Dual-Action - 2.3KG	1	H01075	Coil Hard Hat Tether (Non-Conductive)
2	H01010	V-Gripp Tape	1	H02039P	Phone Gripper with Coil Tether (Non-Conductive)
2	H01085-M	Slip-On Wrist Anchor - Size M	2	H01142	Belt-Loop Anchor
2	H01067	Webbing Wrist Tether Single-Action - 2.5KG	1	H03048	Little Gripper Kit
1	H01110	Bull Bag - 113KG			

TRADE KITS

60 TOOL TETHER KIT WITH BULL BAG & BOLT-SAFE POUCH



This kit provides a comprehensive solution for the serious at-height worker. This kit is designed to cater for virtually any hand tool and tool kits containing up to 60 tools.

KIT CONTENTS				CODE: H01406	
Qty	SKU	Product Name	Qty	SKU	Product Name
20	H01005	Tool Catch - 12mm x 55mm	1	H02101	Bolt-Safe Pouch
20	H01006	Tool Catch - 25mm x 90mm	1	H01035	E-Catch
2	H01057	Dual Arm Tool-Hitch - 16KG	1	H01063	Coil E-Tether With Poly Clip (Non-Conductive)
10	H01021	Swivel Catch			
2	H01073	Bungee Tether Dual-Action 7KG	3	H01037	Tool Ring - 25mm (10 Pack)
2	H01069	Coil Tether Dual-Action - 2.3KG	10	H01030	Screwlock Cable - 3mm x 120mm
2	H01010	V-Gripp Tape	10	H01031	Screwlock Cable - 3mm x 150mm
2	H01085-M	Slip-On Wrist Anchor - Size M	1	H01075	Coil Hard Hat Tether (Non-Conductive)
2	H01067	Webbing Wrist Tether Single-Action - 2.5KG			
1	H01110	Bull Bag - 113.0KG	1	H02039P	Phone Gripper with Coil Tether (Non-Conductive)
			1	H03048	Little Gripper Kit

WIND TECHNICIAN KIT



Perfect for those operating on wind turbines as technicians. With the convenience of a Lockjaw Climbers Bag to contain all your gear, a handy attachment for your mobile phone and the ability to suspend a drill - this is an essential solution for anyone in the wind turbine services industry.

KIT CONTENTS			CODE: H01423		
Qty	SKU	Product Name	Qty	SKU	Product Name
1	H01135	Lockjaw Climbers Bag - 10.0KG			
1	H01088	Adjustable Wrist-Anchor With Tool Tether			
2	H01074	Bungee Tether Triple-Action - 7.0KG			
1	H01037	Tool Ring - 25mm (10 Pack)			
10	H01031	Screwlock Cable - 3mm x 150mm			
10	H01005	Tool Catch - 12mm x 55mm			
1	H01010	V-Gripp Tape			
1	H02039P	Phone Gripper with Coil Tether (Non-Conductive)			
2	H03048	Little Gripper Kit			
1	H02032	Battery Catch Holster			
1	H01077	Webbing Tool Tether/Shoulder Strap - 5.0KG			

WIND TECHNICIAN KIT PLUS



Wind Technician Kit Plus is a premium kit offering a sound selection of transport options, a vast array of connectors, multiple anchor points and several robust tethers.

KIT CONTENTS				CODE: H01424	
Qty	SKU	Product Name	Qty	SKU	Product Name
1	H01141	Mule Tool Backpack - 20KG	1	H02039P	Phone Gripper with Coil Tether (Non-Conductive)
1	H01135	Lockjaw Climbers Bag - 10KG			
1	H02106	Lockjaw Riggers Bag	2	H03048	Little Gripper Kit
1	H01088	Adjustable Wrist-Anchor with Tool Tether	2	H02032	Battery Catch Holster
			2	H01120	Steel Cable Retractor Unit - 0.7KG
2	H01073	Bungee Tether Dual-Action 7KG	1	H01055	Tool Hitch - 16KG
1	H01036	Tool Ring - 19mm (10 Pack)	1	H01056	Single Arm Tool-Hitch - 16KG
1	H01037	Tool Ring - 25mm (10 Pack)	1	H01057	Dual Arm Tool-Hitch - 16KG
1	H01038	Tool Ring - 38mm (10 Pack)	1	H01114	Econo Belt
10	H01031	Screwlock Cable - 3mm x 150mm	1	H01079	Webbing Tether Extra HD Dual-Action - 36.9KG
10	H01005	Tool Catch - 12mm x 55mm			
10	H01006	Tool Catch - 25mm x 90mm	1	H01076	Webbing Tether Heavy Duty Dual-Action - 15.9KG
2	H01010	V-Gripp Tape			
			1	H01077	Webbing Tool Tether/Shoulder Strap - 5KG

TRADE KITS

DUAL TOOL BELT KIT



Lightweight and efficient our Dual Tool Belt Kit offers a sound solution for small tool tethering requirements. Featuring the newly released Dual Tool Holster, GRIPPS carbon neutral certified C5 Eco gloves, leather belt, 2x retractors and a tether, you'll be set to easily tether three tools.

KIT CONTENTS			
Qty	SKU	Product Name	CODE
1	H02075	Dual Tool Holster MKII	H01453
1	H01120	Steel Cable Retractor Unit - 0.7KG	
1	H01125	Kevlar Cable Retractor Unit with-Auto Stop - 0.7KG	
1	H01117-M	Leather Work Belt - 50mm - Medium	
1	S21627-L	C5 Eco Glove - L	
1	H01067	Webbing Wrist Tether Single-Action - 2.5KG	

DUAL TOOL PLUS BELT KIT



Lightweight and efficient our Dual Tool Plus Belt Kit includes everything from our Dual Tool Belt Kit plus a GRIPPS Riggers Bag, extra tether cables and Screwlock Cables providing more options to how you tether your tools.

KIT CONTENTS			
Qty	SKU	Product Name	CODE
1	H02075	Dual Tool Holster MKII	H01454
2	H01120	Steel Cable Retractor Unit - 0.7KG	
1	H01125	Kevlar Cable Retractor Unit with-Auto Stop - 0.7KG	
1	H02106	Lockjaw Riggers Bag	
1	H01117-M	Leather Work Belt - 50mm - Medium	
1	H01072	Bungee Tether Single-Action - 2.5KG	
1	H01068	Coil Tether Single-Action - 1.0KG	
1	H01030-10	Screwlock Cable - 3mm x 120mm (10 Pack)	
1	S21627-L	C5 Eco Glove - L	
1	H01067	Webbing Wrist Tether Single-Action - 2.5KG	

GRIPPS®

GRIPPS
CONQUER GRAVITY

TRADE KITS

PPE DROP PREVENTION PACK



The PPE Drop Prevention Pack helps workers protect their safety gear from falling at heights. The kit features a selection of products that cover essential PPE items such as hard hats, mobile phones, safety glasses and more. All the components of this kit work together to prevent dangerous falls and protect your workers against potential injuries or damage onsite.

KIT CONTENTS			
Qty	SKU	Product Name	CODE
1	H01075	Coil Hard Hat Tether (Non-Conductive)	H07010
1	H02039P	Phone Gripper with Coil Tether (Non-Conductive)	
1	H02056	Tape Measure Catch	
1	H01068	Coil Tether Single-Action - 1KG	
1	H01142	Belt-Loop Anchor	
1	H10000	Safety Glasses Tether	

PPE DROP PREVENTION PACK WITH RADIO



The PPE Drop Prevention Pack With Radio helps workers protect their safety gear from falling at heights. This kit features all the items from the PPE Drop Prevention Pack, plus the addition of the GRIPPS Adjustable Two-Way Radio Holster with Coil E-Tether and E-Catch.

KIT CONTENTS			
Qty	SKU	Product Name	CODE
1	H01075	Coil Hard Hat Tether (Non-Conductive)	H07011
1	H02039P	Phone Gripper with Coil Tether (Non-Conductive)	
1	H02056	Tape Measure Catch	
1	H01068	Coil Tether Single-Action - 1KG	
1	H01142	Belt-Loop Anchor	
1	H02035	Adjustable Two-Way Radio Holster With Coil E-Tether And E-Catch	
1	H10000	Safety Glasses Tether	

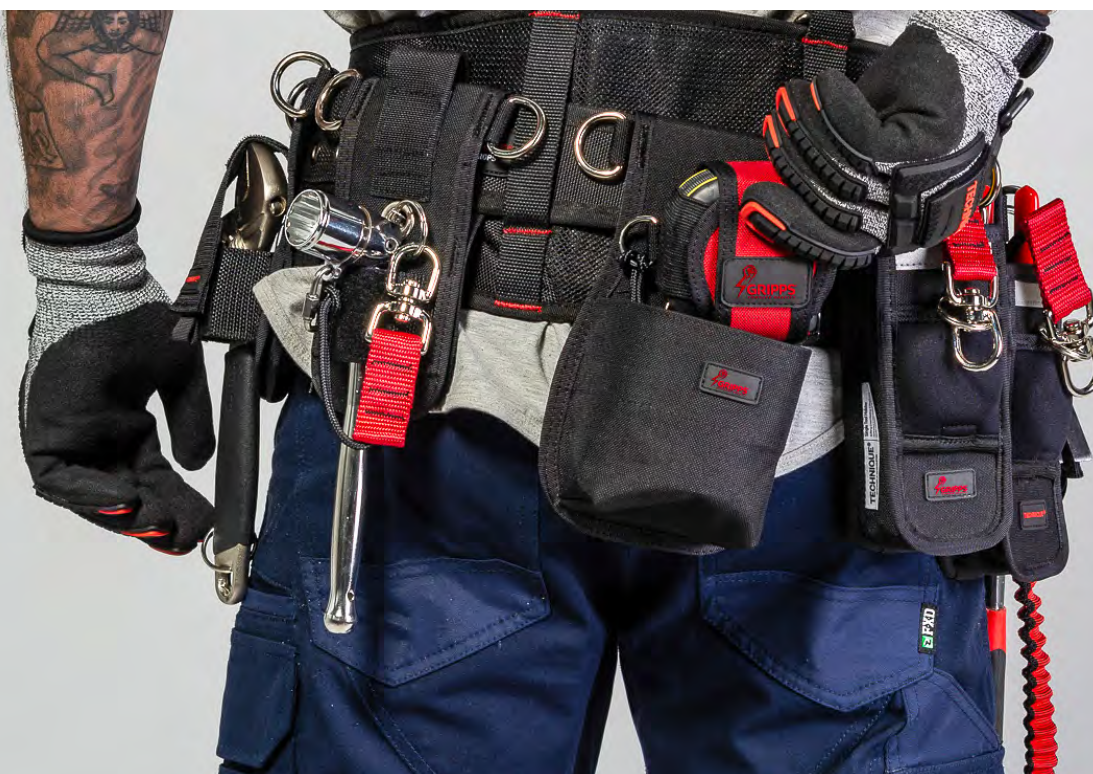



BELT KITS

GRIPPS™

BELT KITS

SCAFFOLDERS KIT- 7 TOOL RETRACTABLE



The fully tethered Retractable 7 Tool Scaffolders Kit comes assembled with seven quality tools and retractable steel tethers, installed on a premium Comfort Work Belt with back support.

Lightweight, functional and extremely heavy-duty, these kits are engineered to provide today's Scaffolders with a tool system that out-performs expectations and is recognised as 'best practice' in the industry.

KEY FEATURES

- Reinforced form-poly belt with 7 holsters.
- Certified and load-rated
- Rigorously site tested
- Lightweight & Ergonomic

KIT CONTENTS		CODE: K02018
Qty	SKU	Product Name
1	H01119	Reinforced Synthetic Work Belt
1	H01118	Ergo-Motion Back Support
5	H01021	Swivel Catch
1	H02062	Claw Hammer Holster
1	H02071	Retractable Single Tool Holster MKII
1	H02072	Retractable Single Tool Holster MKII with Auto-Stop
2	H02091	Retractable Ratchet/Wrench Holster MKII
1	H02049	Retractable Scaffold Key Holster
1	H02081	Retractable Tape Measure Holster MKII
1	H02056	Tape Measure Catch
1	H01073	Bungee Tether Dual-Action 7KG
2	H01030	Screwlock Cable - 3mm x 120mm
1	D13001	Ox Claw Hammer - 20oz
1	K00070	Scaffold Ratchet 21-24mm
1	D28313	Shifter 10"
1	H09010	GRIPPS Nips With Griplock Cable
1	D17010	Stabila Magnetic Scaffolders Level
1	D25010	Scaffolders Tape Measure
1	K00043	Stainless Steel Scaffold Key 1/2 (24mm) with Ring Head Attachment
3	H01120	Steel Cable Retractor Unit - 0.7KG
1	H01102	Seal Kit Bag - 20KG



BELT KITS

SCAFFOLDERS KIT - 7 TOOL RETRACTABLE WITH TOOL CONNECTOR KITS



KO2019

KEY FEATURES

Work at heights using your suite of scaffolding tools with peace of mind they are all tethered safely and conveniently accessible. With a high-quality 7 Tool Belt including holsters, each fitted with retractors. This helps maintain a small profile and minimises the chance of tangles compared to other types of tethers.

Featuring all the essential GRIPPS Connector Packs plus a Scaffolders 7 Tool Belt Kit (Skin Only, with retractors). This provides a wide variety of connectors to suit all sorts of tools from those with existing holes/openings such as wrenches, to tools without any connection points such as hammers. If you want great flexibility and immediate convenience this kit will solve your needs as a professional Scaffolders.



H07000



H07001



H07003



H07005



H07006



H07007



H01102

KIT CONTENTS		CODE: K02017
Qty	SKU	Product Name
1	K02019	Scaffolders Kit - 7 Skin Retractable
1	H07000	Hammer - 2.5KG/5.5LB Solid Handle Connector Pack For Toolbelt
2	H07001	Ratchet/Wrench - 1KG/2.2LB Open Tool Connector Pack For Toolbelt
1	H07003	Nips - 1KG/2.2LB Solid Tool Connector Pack For Toolbelt
1	H07005	Measuring Tape Connector Pack For Toolbelt
2	H07006	Scaffold Key & Level Connector Pack For Toolbelt
1	H01102	Seal Kit Bag - 20KG

BELT KITS

SCAFFOLDERS KIT- 7 TOOL BUNGEE



KEY FEATURES

- H01116 Tool belt & back brace with 7 holsters.
- Complete with 7 tools fitted with connection points and bungee tether's.
- Certified, load rated and rigorously site tested.

KIT CONTENTS				CODE: K02025	
Qty	SKU	Product Name	Qty	SKU	Product Name
1	H01116	Comfort Work Belt With Back Support	1	D28313	Shifter 10"
1	H02080	Tape Measure Holster MKII	1	H09010	GRIPPS Nips With Gripplock Cable
1	H02056	Tape Measure Catch	1	D13001	Ox Claw Hammer - 20oz
2	H02090	Ratchet/Wrench Holster MKII	1	D17010	Stabila Magnetic Scaffolders Level
2	H02070	Single Tool Holster MKII	1	D25010	Scaffolders Tape Measure
1	H02047	Scaffold Key Holster	1	K00043	Stainless Steel Scaffold Key 1/2 (24mm) with Ring Head Attachment
1	H02062	Claw Hammer Holster	2	H01030	Screwlock Cable - 3mm x 120mm
7	H01073	Bungee Tether Dual-Action 7KG	1	H01102	Seal Kit Bag - 20KG
1	K00070	Scaffold Ratchet 21-24mm			

SCAFFOLDERS KIT- 7 SKIN



KEY FEATURES

- 7 Holsters with provision for retractable or coil/bungee tethers.
- Load-rated and certified for use with tool tethers.
- Premium quality and lightweight.

KIT CONTENTS				CODE
Qty	SKU	Product Name		
1	H01119	Reinforced Synthetic Work Belt		K02021
2	H02070	Single Tool Holster MKII		
1	H02080	Tape Measure Holster MKII		
2	H02090	Ratchet/Wrench Holster MKII		
1	H02047	Scaffold Key Holster		
1	H02062	Claw Hammer Holster		

SCAFFOLDERS KIT- 7 SKIN RETRACTABLE



KEY FEATURES

- H01116 Tool belt & back brace with 7 certified holsters.
- 6 holsters fitted with retractable tethers & hammer holster & bungee tether.
- Certified, premium quality and lightweight.

KIT CONTENTS				CODE
Qty	SKU	Product Name		
1	H01119	Reinforced Synthetic Work Belt		K02019
1	H01118	Ergo-Motion Back Support		
1	H02049	Retractable Scaffold Key Holster		
1	H02071	Retractable Single Tool Holster MKII		
1	H02072	Retractable Single Tool Holster MKII with Auto-Stop		
1	H02081	Retractable Tape Measure Holster MKII		
1	H02056	Tape Measure Catch		
1	H02062	Claw Hammer Holster		
2	H02091	Retractable Ratchet/Wrench Holster MKII		
1	H01073	Bungee Tether Dual-Action 7KG		

BELT KITS

SCAFFOLDERS KIT- 5 TOOL RETRACTABLE



KEY FEATURES

- Complete 5 holster scaffold kit fitted with tools.
- 4 holsters fitted with retractable tethers and hammer holster with 1 x bungee tether.

KIT CONTENTS				CODE: K02027	
Qty	SKU	Product Name	Qty	SKU	Product Name
1	H01119	Reinforced Synthetic Work Belt	2	H01030	Screwlock Cable - 3mm x 120mm
4	H01021	Swivel Catch	1	D13001	Ox Claw Hammer - 20oz
1	H02062	Claw Hammer Holster	1	K00070	Scaffold Ratchet 21-24mm
2	H02091	Retractable Ratchet/Wrench Holster MKII	1	D28313	Shifter 10"
1	H02072	Retractable Single Tool Holster MKII with Auto-Stop	1	D17010	Stabila Magnetic Scaffolders Level
1	H02081	Retractable Tape Measure Holster MKII	1	D25010	Scaffolders Tape Measure
1	H02056	Tape Measure Catch	3	H01120	Steel Cable Retractor Unit - 0.7KG
1	H01073	Bungee Tether Dual-Action 7KG	1	H01102	Seal Kit Bag - 20KG

SCAFFOLDERS KIT- 5 TOOL BUNGEE & COIL



KEY FEATURES

- Complete 5 holster scaffold kit fitted with tools .
- 4 holsters fitted with coil tethers and hammer holster with 1 x bungee tether.

KIT CONTENTS				CODE: K02026	
Qty	SKU	Product Name	Qty	SKU	Product Name
1	H01119	Reinforced Synthetic Work Belt	1	D13001	Ox Claw Hammer - 20oz
1	H02070	Single Tool Holster MKII	1	K00070	Scaffold Ratchet 21-24mm
1	H02062	Claw Hammer Holster	1	D28313	Shifter 10"
2	H02090	Ratchet/Wrench Holster MKII	1	D25010	Scaffolders Tape Measure
1	H02080	Tape Measure Holster MKII	1	D17010	Stabila Magnetic Scaffolders Level
1	H02056	Tape Measure Catch	4	H01030	Screwlock Cable - 3mm x 120mm
4	H01068	Coil Tether Single-Action - 1KG	1	H01102	Seal Kit Bag - 20KG
1	H01073	Bungee Tether Dual-Action 7KG			

FORMWORKERS KIT - 5 TOOL RETRACTABLE (BOLT-SAFE POUCH EDITION)



KEY FEATURES

- Complete 5 holster formworkers kit fitted with tools.
- 4 holsters fitted with retractable tethers, a hammer holster with 1 x bungee tether and a Bolt Safe Pouch to secure small items such as nuts or bolts.

KIT CONTENTS				CODE: K02030	
Qty	SKU	Product Name	Qty	SKU	Product Name
1	H01119	Reinforced Synthetic Work Belt	1	D25010	Scaffolders Tape Measure
1	H02101	Bolt-Safe Pouch	1	D13001	Ox Claw Hammer - 20oz
1	H02071	Retractable Single Tool Holster MKII	1	D28313	Shifter 10"
2	H02091	Retractable Ratchet/Wrench Holster MKII	1	K00070	Scaffold Ratchet 21-24mm
1	H02081	Retractable Tape Measure Holster MKII	1	H09010	GRIPPS Nips With Gripplock Cable
1	H02056	Tape Measure Catch	3	H01021	Swivel Catch
1	H02062	Claw Hammer Holster	2	H01030	Screwlock Cable - 3mm x 120mm
1	H01073	Bungee Tether Dual-Action 7KG	1	H01102	Seal Kit Bag - 20KG

BELT KITS

FORMWORKERS KIT - 5 SKIN RETRACTABLE (BOLT-SAFE POUCH EDITION)



KEY FEATURES

- H01116 Tool belt with 5 certified holsters.
- 4x holsters fitted with retractable tethers and hammer holster with 1x bungee tether.
- Bolt Safe Pouch to secure small items such as nuts or bolts

KIT CONTENTS			
Qty	SKU	Product Name	CODE
1	H01119	Reinforced Synthetic Work Belt	K02031
1	H02071	Retractable Single Tool Holster MKII	
2	H02091	Retractable Ratchet/Wrench Holster MKII	
1	H02081	Retractable Tape Measure Holster MKII	
1	H02062	Claw Hammer Holster	
1	H02101	Bolt-Safe Pouch	
1	H01073	Bungee Tether Dual-Action 7KG	
1	H01102	Seal Kit Bag - 20KG	

BATTERY TOOL HOLSTER BELT RETRACTOR KIT



Protect your battery power tools against drops with this economic kit.

Create an instant load-rated tool connector point by choking the Swivel Catch around the closed handle of your power tool, then tether to your work belt via the retracting Tool Grapple®.

Simply drop your power tool into the BOA Holster to keep it secure at all times when not in use.

KIT CONTENTS			
Qty	SKU	Product Name	CODE
1	H02031	BOA Holster	H02031P
1	H01021	Swivel Catch	
1	H01122-C	Tool Grapple with Dual Locking Carabiner	

BATTERY CATCH HOLSTER BELT RETRACTOR KIT



Protect your battery power tools against drops with this economic kit.

Compatible with all standard work belts, the retractable Tool Grapple® connects to your battery tool via the easy-to-install Battery Catch Holster, which creates a load-rated tool connector point by securing around the battery of your power tool.

Simply drop your power tool into the BOA Holster to keep it secure at all times when not in use.

KIT CONTENTS			
Qty	SKU	Product Name	CODE
1	H02031	BOA Holster	H02032P
1	H02032	Battery Catch Holster	
1	H01122-C	Tool Grapple with Dual Locking Carabiner	

ENCAPSULATION & MATTING

GRIPPS®

NEW GAP WRAP

FIRE RESISTANT AS1530.3

SIZES: 12" | 24" | 36"



*PATENT PENDING

ENCAPSULATION & MATTING

GAP WRAP 12" / 24" / 36"



PATENT PENDING

SIZE CHART

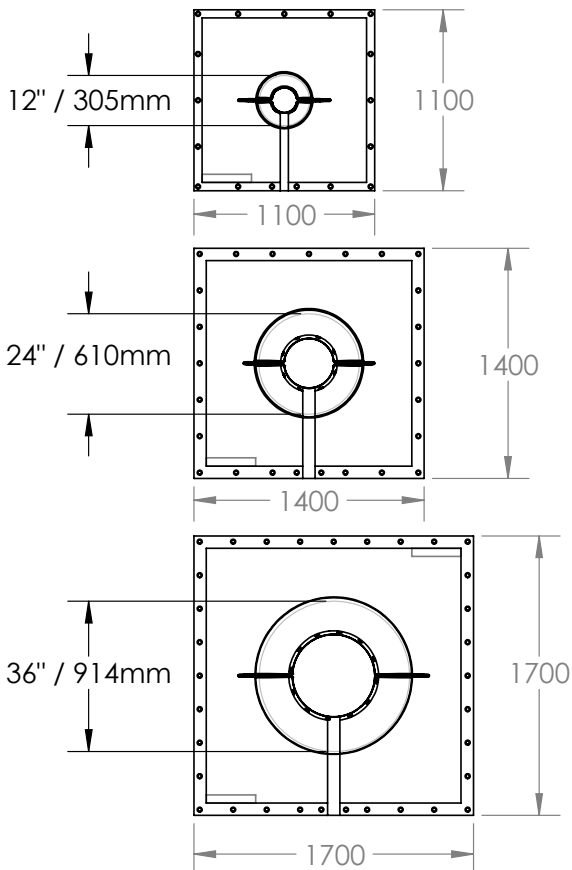

The GRIPPS Gap Wrap is a unique encapsulation device, designed to eliminate the gap found around pipes that run vertically through jobsite flooring.

It is quick and easy to install, can be moved from one pipe to another and has a heavy-duty Velcro closure that accommodates a variety of pipe diameters and cross sections. Three models cover all pipe diameters up to 36" or 914mm. The Stainless steel eyelets can easily be tied together for extra security.

Durable PVC coated polyester mesh allows workers to see the void beneath and bright red PVC edging can be fixed down to a variety of materials, ensuring the GRIPPS Gap Wrap can withstand larger dropped objects.

KEY FEATURES

- Fire Resistant to AS1530.3
- Fit Pipe up to 36" or 914mm
- Re-usable and adjustable
- Velcro closures and eyelets for added security
- PVC coated Polyester mesh. (The same high-quality mesh used in our GRIPPGRID matting)
- Red PVC edging for strength and visual warning

SIZE	PIPE DIAMETER SIZES	LENGTH	WIDTH	HEIGHT	CODE
12"	2" - 12" 50 mm - 305 mm	43" 1100mm	43" 1100mm	12" 500mm	H06010
24"	2" - 24" 50 mm - 610 mm	55" 1400mm	55" 1400mm	24" 650mm	H06011
36"	2" - 36" 50 mm - 914 mm	67" 1700mm	67" 1700mm	36" 800mm	H06012



ENCAPSULATION & MATTING

GAP MAT



The GRIPPS Gap Mat is a durable, fire-resistant drop-prevention mat with dedicated anchor points for tethering.

With 6x D-Rings covering the mat, tools or equipment are easily attached, providing several anchor points. The Gap Mat is easily secured using cable ties (or similar ties) with the 22 available eyelets surrounding the edges.

The Gap Mat allows personnel to work on grid mesh platforms whilst protecting their tools and equipment from falling through the grating and is reusable thanks to the highly durable mesh.

KEY FEATURES

- Re-use from job-to-job and save compared to disposable solutions
- Fire Resistant Mesh to AS1530.3
- Dual-Purpose - also can be applied to rails if required
- High Visibility with bright red PVC edging
- Custom sizing is Available to lengths you require for your worksite



FIRE RATING	LENGTH	WIDTH	CODE
AS1530.3	98" 2.5m	39" 1 m	H06030

CUSTOM SIZING AVAILABLE!

Enquire with GRIPPS staff about your specific matting needs.

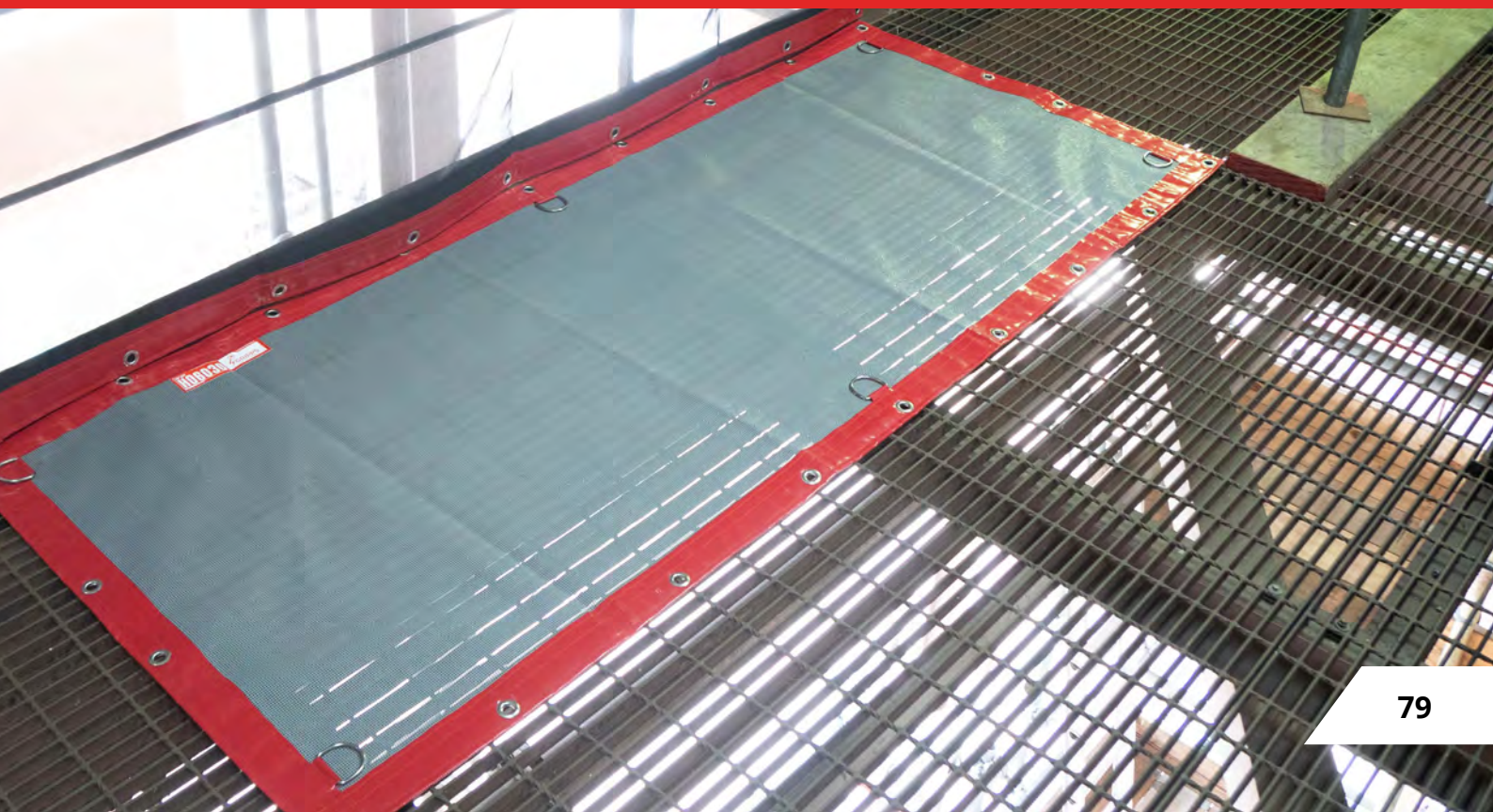

ENCAPSULATION & MATTING

GAP SCREEN

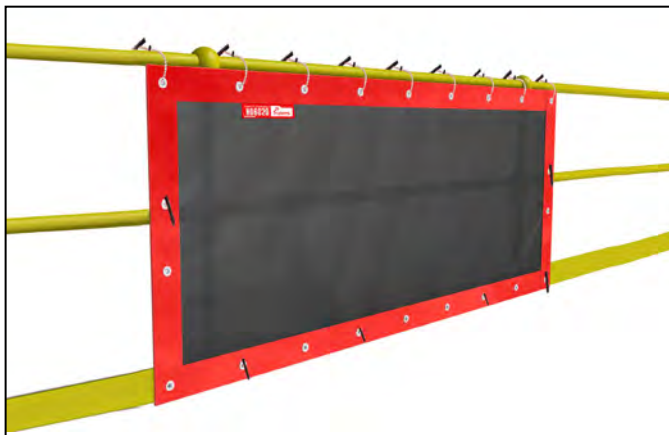

The GRIPPS Gap Screen is an economic fire-resistant drop prevention barrier for handrails. The Gap Screen allows personnel to work on platforms at height whilst protecting their tools and equipment from rolling off platform edges. The Gap Screen is secured using cable ties (or similar) via the 22 available stainless steel eyelets.

KEY FEATURES

- Re-use from job-to-job and save compared to disposable solutions
- Fire Resistant Mesh
- High Visibility
- Custom sizing is available to lengths you require for your worksite



FIRE RATING	LENGTH	WIDTH	CODE
AS2755-2	98" 2.5m	39" 1 m	H06020

CUSTOM SIZING AVAILABLE!

Enquire with GRIPPS staff about your specific matting needs.



ENCAPSULATION & MATTING

GRIPPGRID

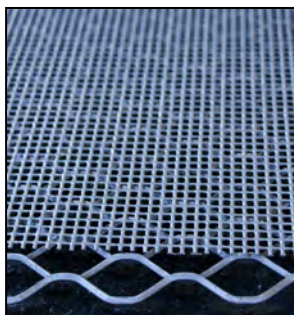

This heavy-duty reusable matting is designed to eliminate dropped object hazards by effectively encapsulating grid mesh platforms. Suitable for all height works conducted on grip mesh platforms, GRIPPGrid provides a cost-effective drop matting that can be reused multiple times. GRIPPGrid matting is fire-resistant and reusable, making it the ideal choice for grid mesh platform works.

KEY FEATURES

- Heavy-duty & long-lasting and can be used multiple times.
- Fire resistant.
- Very high UV resistance.
- Available in 2 different weights.

SIZE	WEIGHT	CODE
1.87m x 26m 6' x 82'	430 G/M ²	H01316
1.87m x 25m 6' x 82'	530 G/M ²	H01317

	GRIPPGRID 430	GRIPPGRID 530
Base Fabric	Polyester	
Coating PVC	PVC	
Weight (g/m ²)	430	530
Fire Retardant	AS 1530.3	
Roll Size (m)	1.87m x 26m	1.87m x 25m
Colour	Grey, Black, White	Grey

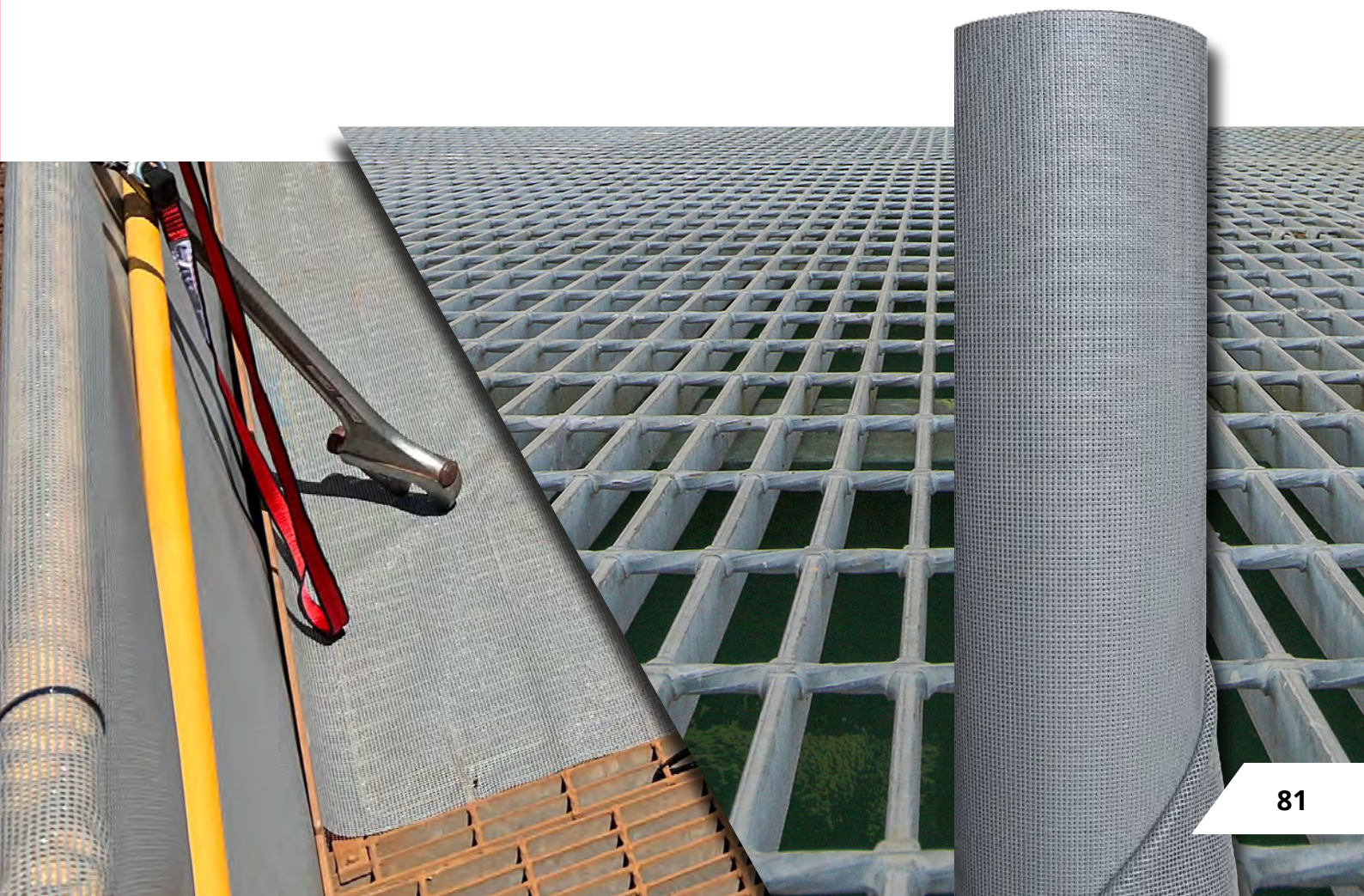

ENCAPSULATION & MATTING

MODULAR DROP MAT

ANSI/ISEA 121-2018
COMPLIANT



Made from a heavy-duty, self-extinguishing canvas, The GRIPPS® Modular Drop Mat provides a safe personal work area for works conducted on GRIDMESH® or steel grate flooring.

The Modular Drop Mat mitigates dropped object incidents by allowing workers to conduct virtually any task without fear of small objects falling through the mesh.

KEY FEATURES

- Heavy-duty 26oz. self-extinguishing canvas.
- Moveable Velcro kneeling pads.
- Eight load-rated D-Rings for tethering tools.
- Zips on each side allow you to attach an unlimited number of Drop Mats to each other.
- Folds up and attaches directly to the GRIPPS® Mule Bag through purpose-made carabiners.

SIZE WHEN OPEN (WIDTH X HEIGHT X DEPTH)	SIZE WHEN FOLDED (WIDTH X HEIGHT X DEPTH)	MAX LOAD (D-RING)	CODE
1100 mm x 1100 mm x 5.0 mm 43" x 43" x 2.0"	530 mm x 280 mm x 90 mm 21" x 11" x 3.5"	3.0 kg 6.5 lbs	H01307

GRIPPAIR

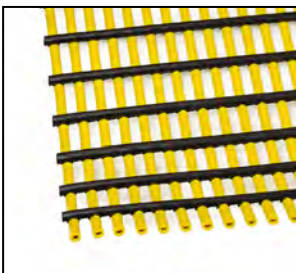
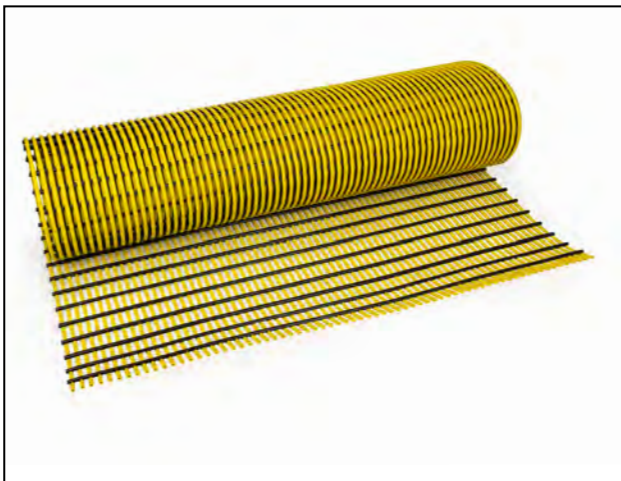

GrippAir is designed and manufactured in Australia from non-toxic food grade PVC tubes, providing excellent longevity as well as comfort and support underfoot.

Constructed in a grid formation, GrippAir is both flame and chemical resistant and can be installed in minutes on even or uneven surfaces. Easy to roll up and clean, GrippAir is reusable and can be cut to any size or shape.

KEY FEATURES

- Long-lasting, reusable, easy to fit & clean.
- Impervious to most liquids, acids & hydrocarbons.
- Excellent slip resistance.
- Suitable for marine environments.
- UV resistant.
- Made from 100% food-grade materials.
- Made in Australia.

FIRE RATING	LENGTH	WIDTH	CODE
AS1530.3	32ft 10m	900 mm 35"	H01315-90

DROP ZONE MANAGEMENT

GRIPPS[®]

DROP ZONE MANAGEMENT

STOP THE DROPS CAMPAIGN PACK



KEY FEATURES

- 10x Mandatory Signs
- 20x GRIPPS Waterboy
- 6x Safety Posters
- 50x GRIPPS Awareness Pens
- 2x Safety Vinyl Banners
- 50x GRIPPS Awareness Checklists

FORMATS	CODE
Print / Digital / Inventory - Visit GRIPPS website for more info	H05022

DROP ZONE BARRIER TAPE



KEY FEATURES

- Heavy-duty reflective barrier tape displaying "DANGER DROP ZONE" with high-vis red stripes, for creating a temporary drop zone.

WIDTH	LENGTH	CODE
5.0 cm 2.0"	100 m 33'	HS-3010

BUNTING SAFETY FLAGS ON ROPE



KEY FEATURES

- Hi-vis orange flags and blue flags on rope line displaying: "DANGER DROP ZONE"

COLOUR	LENGTH	CODE
Blue	3.0 m 10'	HS-E02002
Orange	3.0 m 10'	HS-E02000

MANDATORY SIGN



KEY FEATURES

- Corflute mandatory sign. "TOOL TETHERS MUST BE USED WHEN WORKING ABOVE 2 METRES".
- Custom branding available.
- Complies with AS 1319 regulations

WIDTH	LENGTH	CODE
450mm 18"	600mm 24"	HS-4010



TETHER READY TOOLS

GRIPPS®

TETHER READY TOOLS

STAINLESS STEEL SCAFFOLD KEY 1/2



KEY FEATURES

- Premium quality stainless steel 1/2, scaffold key with poker handle. Includes swivel anchor point.

SIZE	TETHER MIN LENGTH	TETHER MAX LENGTH	TETHER MAX LOAD
1/2 Whitworth 24 mm	40cm 16"	1.6m 63"	1.0 kg 2.0 lbs

VARIATION	CODE
SCAFFOLD KEY ONLY	K00043
WITH COIL TETHER	K00044

STAINLESS STEEL SCAFFOLD KEY 7/16



KEY FEATURES

- Premium quality stainless steel 7/16, scaffold key with poker handle. Includes swivel anchor point.

SIZE	TETHER MIN LENGTH	TETHER MAX LENGTH	TETHER MAX LOAD
7/16 Whitworth/21 mm	40cm 16"	1.6m 63"	1.0 kg 2.0 lbs

VARIATION	CODE
SCAFFOLD KEY ONLY	K00045
WITH COIL TETHER	K00045P

SCAFFOLD RATCHET



KEY FEATURES

- Engineered from premium grade forged steel, with the heaviest duty mechanism available and balanced to perfection, these ratchets provide a trusty and integral component in every Scaffolders tool kit.

SIZE	CODE
21 mm x 24 mm 0.8" x 1.0"	K00070
21 mm x 23 mm 0.8" x 0.9"	K00071
19 mm x 24 mm 0.75" x 1.0"	K00072
18 mm x 24 mm 0.7" x 0.9"	K00073

SHIFTER - 10"



KEY FEATURES

- Versatile and ergonomic handle. This Shifter is designed to fit comfortably in your hand, making it easy to tackle any task with precision and accuracy. Lightweight design and providing great control.
- Trusted IREGA brand product, made in Spain.

SIZE	CODE
10" 250mm	D28313

TETHER READY TOOLS

OX CLAW HAMMER - 20oz



KEY FEATURES

- Crafted from a single piece of high-quality steel
- Straight claw ending
- Non-slip Ox grip handle to ensure utmost accuracy when driving nails.

SIZE	CODE
20 OZ	D13001

GRIPPS NIPS WITH GRIPPLOCK CABLE



KEY FEATURES

- ORBIS German made product
- Superior quality finish for durability
- Ergonomic non-slip plastic grips
- Extra wide cutting edge

SIZE	CODE
200mm / 8"	H09010

STABILA MAGNETIC SCAFFOLDERS LEVEL



*Swivel Catch not included

KEY FEATURES

- German made STABILA trusted brand
- Die-cast aluminium body for precision leveling
- In-built hole for adding swivel catch or similar tool tether connectors

SIZE	CODE
NA	D17010

SCAFFOLDERS TAPE MEASURE



KEY FEATURES

- Remains rigid whilst extended at great length
- Double sided blade printing with nylon coating
- Wide blade
- Reinforced 4 rivet dual-hook with magnet ending

SIZE	CODE
85mm x 80mm x 45mm	D25010

GRIPPS®

AUSTRALIA - HEAD OFFICE

+61 3 8383 9458
sales.au@gripps.com

15 Steele Court, Tullamarine,
Victoria, 3043,
Australia

NORTH AMERICA

+1 248 658 8999
sales@gripps.com

31435 Stephenson Highway,
Madison Heights,
Michigan 48071,
United States

UNITED KINGDOM

+44 1273 832 200
sales.uk@gripps.com

The Gatwick Metro Centre,
Unit 4B, Balcombe Rd,
Horley, RH6 9GA
England

EUROPE

+31 88 697 2565
sales.eu@gripps.com

Oud Camp 22
3155 DL Maasland
The Netherlands

GRIPPS.COM



#ConquerGravity