

Lander (short)

Lander is a collection of classic light fixtures reimagined through the craft of woodturning. The statement hardwood pieces are paired with the timeless illuminated sphere. Light is captured and gently dispersed by the solid walls of the timber shade, creating a gentle atmosphere reminiscent of the moon on a clear night.

Technical Details

Application	Bedside Tables, Feature Pendant
Dimensions	ø171 x 165mm
Material	Solid Hardwood, Glass Opal Bulb, E27 Lampholder, Textile Cord
Bulb	ø95mm Matte Opal Glass. Environmentally friendly and flicker-free light
Input Power	240V AC
CRI	90
Wattage	8W
Lumens	800lm
Colour Temperature	3000K Warm White
Dimming	Yes



Create a Custom Pendant

Pendant	Lander (short)	LS
Timber	Victorian Ash Tasmanian Blackwood White Oak Custom	VA TB WO C
Cable Colour	White Textile Black Textile Custom	WC BC CC
Gripper Colour	White Black Solid Brass Custom	WH BL BR CU
Ceiling Plate	Canopy Ø80	80
Ceiling Plate Colour	White Black Solid Brass Solid Copper Custom Powdercoat	W B C B P
Cable Drop Length	1.5m Standard Custom	1.5m _m

Timber

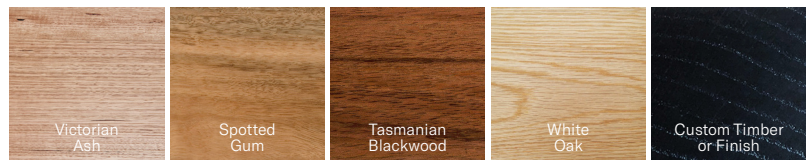

Dimensions

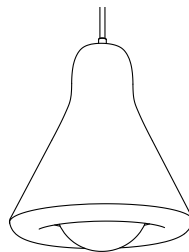

Lander
ø244 x 270

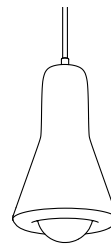

Lander (tall)
ø151 x 242

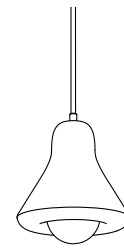

Lander (short)
ø171 x 165mm

Ceiling Plate



Small Plate
Ø76 x 8 mm

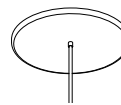

Large Plate
Ø106 x 8 mm

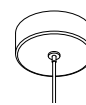

Canopy
Ø80 x 25 mm

Lander (short)

Ceiling Plate Details

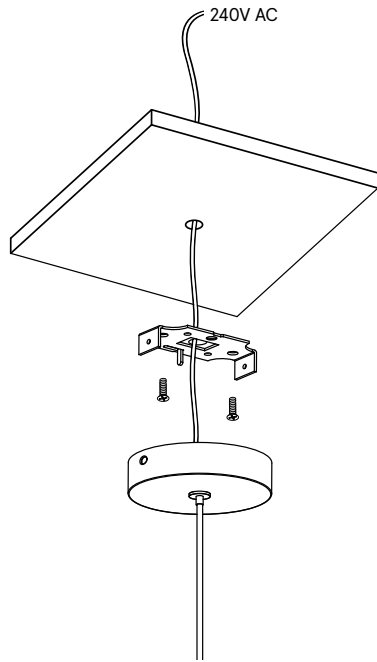

Canopy
Ø80 x 25mm

Suitable for full ceiling
access to place the remote
driver from above.

Cutout hole: 10-20mm