

# CAMPLUX

## 2.64 GPM RV TANKLESS WATER HEATER

Instruction For Installation And Use

Model: RS264/RS264B



Model: RS264/RS264B

Optional Colour



1

Thank you for purchasing this Camplux RV tankless water heater. Before operating your new product, please read these instructions carefully. This will ensure safe use and reduce the risk of injury.

This instruction manual contains information for installation, operation, maintenance of the product and safe use.

## WARNING

If the information in these instructions is not followed exactly, a fire or explosion may result, causing property damage, personal injury, or death.

Do not store or use gasoline or other flammable vapors and liquids in the vicinity of this or any other appliance.

## What to do if you smell gas

- Evacuate all persons from the vehicle.
- Shut off the gas supply at the gas container or source.
- Do not touch any electrical switch or use any phone or radio in the vehicle.
- Do not start the vehicle's engine or electric generator.
- Contact the nearest gas supplier or certified service technician for repairs.
- If you cannot reach a gas supplier or certified service technician, contact the nearest fire department.
- Do not turn on the gas supply until gas leaks have been repaired.



Installation and service must be performed by a certified service technician, service agency, or the gas supplier.



# Table of Contents

|                                   |       |
|-----------------------------------|-------|
| Table of Contents .....           | 2     |
| General Safety .....              | 3-5   |
| Product Overview & Features ..... | 6-9   |
| Installation & Operation .....    | 10-29 |
| Wiring Diagram .....              | 29    |
| Check After Installation .....    | 30-31 |
| Operation Instruction .....       | 32-34 |
| Winterizing Opration .....        | 34-37 |
| Troubleshooting .....             | 39-42 |



## General Safety

### User safety information

#### About safety symbols and signal words

- Indicates an imminently hazardous situation which, if not avoided, will result in death or serious injury.
- DANGER:** Indicates a hazardous situation which, if not avoided, will result in death or serious injury.
- WARNING:** Indicates a hazardous situation which, if not avoided, could result in death or serious injury.
- CAUTION:** Indicates a hazardous situation which, if not avoided, could result in minor or moderate injury.
- NOTICE:** It is used to address practices not related to physical injury.

#### Intended use

- The unit may be used only to heat water in recreational vehicles (RVs) that are used for recreation, travel, or camping.
- RVs are recreational vehicles designed as temporary living quarters for recreation, camping, or travel use. Such vehicles have their own power or are towed by another vehicle.

#### Prohibited use

- Any use other than the intended use (see above) is prohibited.

#### Examples of prohibited use

- Use in food trucks or roadside food vending vehicles.
- Use in construction trailers.
- Use as a pool heater.
- Use in a marine environment.
- Use as part of a space heating system.
- Use in mobile homes.

#### California proposition 65

Lists of chemical substances are known to the state to cause cancer, congenital disabilities, death, serious illness, or other reproductive harm. This product may contain such substances or such substances may be formed from combustion of fuel (gas) or be components of the product itself.



## Responsibilities of operator

- The operator is responsible for their own health and safety, persons with pacemakers should discuss this with their doctor before opening the access door, or performing any service repairs.
- The operator is responsible for the water quality used in the appliance.
- The operator is responsible for all routine inspections found in the Cleaning and Maintenance section of this manual.
- The operator is responsible for using and maintaining gas cylinders as specified by the RV manufacturer.
- The operator is responsible for ensuring no spray water enters the appliance when cleaning the RV.
- The operator is responsible for using the appliance for potable water only. They are responsible for ensuring non-potable water sources, components, or heating systems, new or old, are not connected to the appliance.

## Important safety instructions

- Read these instructions carefully to ensure the safe and correct operation of your appliance. Retain the instruction manual and installation instructions for future use.

## Ensuring a safe operating environment

- Read these instructions carefully to ensure the safe and correct operation of your appliance. Retain the instruction manual and installation instructions for future use.



### **DANGER**

#### **Suffocation or Fire Hazard**

- Exhaust gases are hot and contain carbon monoxide, do not breath or obstruct the exhaust gases.
- Failure to follow the instruction will lead to serious injury, property damage, or death.



- **NEVER** use this appliance in enclosed spaces or tents.
- **ALWAYS** turn the appliance off, and shut off the fuel supply while parking the RV in an enclosed space, such as a garage or repair shop.
- **NEVER** place seating or picnic tables in the direct path of the exhaust outlet.
- **DO NOT** use this water heater without a working carbon monoxide detector installed in the RV. Follow the manufacturer's instructions and guidelines for its installation.
- **ALWAYS** keep the air intake and exhaust outlet free of obstructions in order to ensure clean combustion.
- **DO NOT** place articles on or against the appliance.
- **DO NOT** lean any objects against the water heater's access door or place any foreign objects within 24" of the access door.
- **DO NOT** use or store flammable materials near the appliance.
- **DO NOT** spray aerosols in the vicinity of the appliance while it is in operation.
- **DO NOT** modify the appliance.

## While Driving

- The operator is responsible for ensuring all components are seated and locked in place before moving the RV, check the following:  
The access door is flush with the mounting plate. The door locker is engaged.
- The operator is responsible for ensuring the gas system is turned off at the gas cylinders before transit. Turn off all necessary valves as indicated by the RV manufacturer.
- The operator is responsible for making sure the appliance is off when refueling, traveling through tunnels, parking in garages or carports, or on ferries.



# Product Overview & Features

## Product overview



## How to open the door?

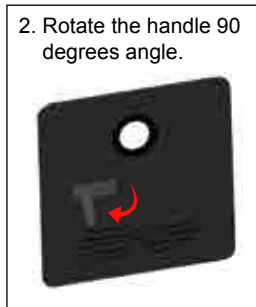

# Wall controller

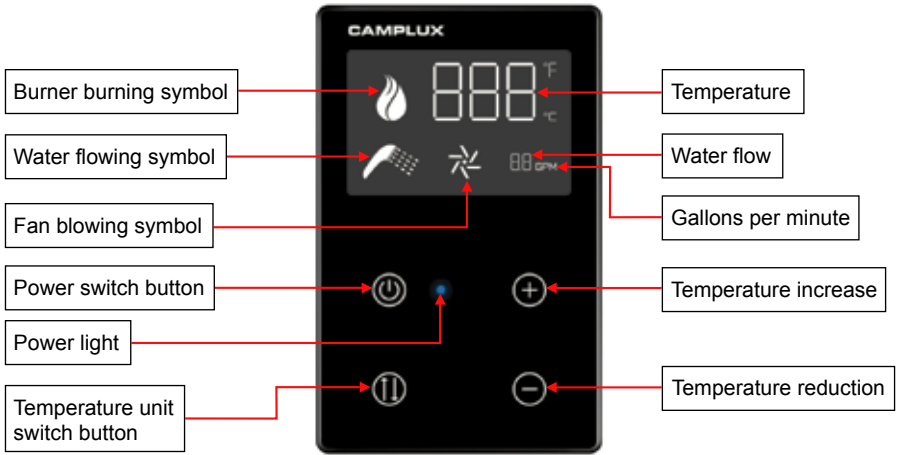

# Connection for water and gas supply

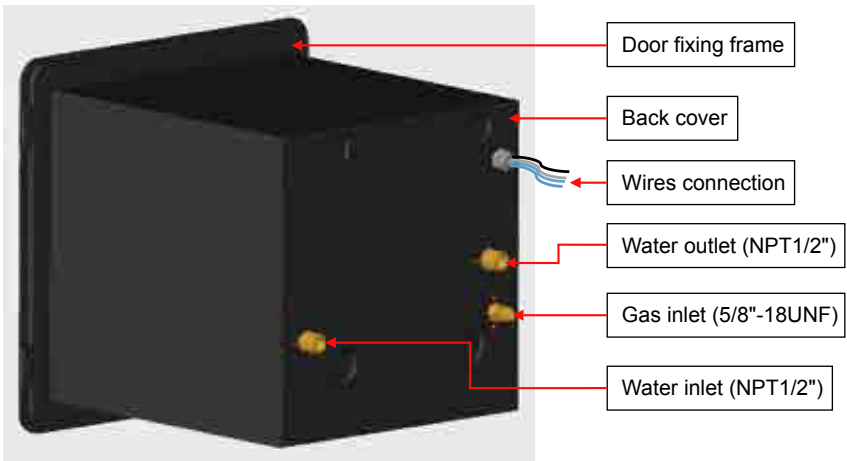



## Product safety features

The appliance is equipped with the following safety devices:

- **Flame monitoring device**

If the flame goes out, the gas supply to the burner is switched off by the device.

- **Anti-freeze function**

The appliance is equipped with an anti-freeze device, when the outdoor temperature drops below freezing the unit will automatic heating the water system to 48 degrees Fahrenheit then the unit will stop (Note: Need to turn on the power and gas supply during the anti-freeze time).

- **Power positive and negative wires reverse protection**

If the wires of the powerful positive and negative connection are reversed, the unit will cut off the power to protect the PCB.

- **Low-voltage/over-voltage shutdown**

If the voltage drops below 10V DC (or rises above 17V DC), the appliance shuts off.

- **Over-current protection**

If there is a short circuit in the appliance (>10 A), a fuse on the control unit is activated and the appliance is switched off.

- **Hot water temperature monitoring**

A water over-temperature switch avoids excessively high water temperatures in case of an error.

- **Flue fan monitoring**

If there is a failure of the flue fan, the gas supply to the burner is switched off.

- **Temperature fluctuation eliminator**

The appliance is equipped with a temperature fluctuation eliminator. If the water flow is suddenly decreased to a small flow (0.4 GPM) that will cause a high rise temperature, the fluctuation eliminator can eliminate the rising temperature to avoid scalding injuries, and make sure the bather gets comfortable bath.

- **Over pressure protection**

The appliance is equipped with a pressure relief valve that complies with the standard for Relief Valves for Hot Water Supply Systems, ANSI Z21.22.



## Product basic function

The appliance was designed exclusively for use in recreational vehicles. The appliance is connected between the vehicle's fresh water supply and its hot water plumbing system.

Based on the hot water demand, the tankless water heater will heat incoming cold water to the desired output temperature by monitoring key sensors to regulate the thermal energy released over a large heat exchanger. This creates a more useful and energy-efficient heating system versus the conventional tank water heater that wastes fuel during re-heat cycles and is limited on volume output.

## Product specifications

| Specifications  |                                      |                       |
|---|--------------------------------------|-----------------------|
| BTU/HR (Nominal input rate)                                   | 65,000 BTU                           |                       |
| Hot water capacity (Gallon/m, @ $\Delta 45^{\circ}\text{F}$ ) | 2.64                                 |                       |
| Fuel type   | Propane (LP Gas)                     |                       |
| Fuel inlet pressure   | 10.5 in.wc-14 in. wc / 2620Pa-3490Pa |                       |
| Manifold pressure   | 0.85 in.wc-6.4 in.wc / 210Pa-1600Pa  |                       |
| Power input   | 12V DC<3 Amp                         |                       |
| Water operating pressure                                      | 10 PSI-65 PSI                        |                       |
| Burner orifice (mm)   | 5 x $\varnothing$ 1.2                |                       |
| Working altitudes: 0 2000ft (0~610m)                          | Manifold Pressure (Pa)               | 1600                  |
| Product dimensions (W x H x D)                                | 12.6" x 12.5" x 14.74"               |                       |
| Assembly (body and door) dimensions (W x H x D)               | Body with Door                       | 15.2" x 15.1" x 15.4" |
| Installation cutout and depth dimensions (W x H x D)          | 12.8" x 12.7" x 19.7"                |                       |
| Shipping weight (lbs/kg)                                      | 29.8/13.5                            |                       |
| Setting temperature range                                     | 95°F (35°C)~124°F (51°C)             |                       |











# Installation & Operation

## What is in the box?

Remove the product from the packaging and make sure you have the following list of items included. If any item is damaged or missing, contact us or the dealer.

 **WARNING**

**Suffocation Hazard**  
 Dispose of packaging material or keep it from the reach of small children. Failure to follow instructions could lead to serious injury or death.

| Part  | Description                         | Quantity |
|---|-------------------------------------|----------|
| <b>Water Heater</b>   |                                     |          |
|    | Main body                           | 1        |
|    | Wall controller                     | 1        |
|   | Door assembly                       | 1        |
|  | ST4.2x30 screws (door fixing)       | 14       |
|  | ST4.2x20 screws (controller fixing) | 2        |
|  | Wire connectors                     | 6        |
|  | Use and care manual                 | 1        |
|  | Warranty card                       | 1        |



## Installation

Read, observe, and follow these safety instructions to avoid injuries during installation or operation.

### Installation safety

The installation of this appliance, along with all subsequent components to support the installation and operation of the appliance, must conform to country, state, and local codes. In the absence of such codes, refer to the latest editions of:

#### USA:

NFPA 1192 - Recreational Vehicles (RV)

- ANSI A119.5-Park Model RV
- ANSI/RVIA LV-Low Voltage Standard
- NFPA 70-National Electric Code

#### Canada:

- CSA Z240 RV Series-Recreational Vehicles
- CSA Z241 Park Model RV
- CSA C22.1-Canadian Electric Code



#### CAUTION

Always wear protective gear such as gloves eyewear and clothing to avoid injuries during installation and service of the appliance.



#### DANGER

##### Suffocation and/or Fire Hazard

Observe all installation material in accordance with governing codes and ordinances. Failure to the following instructions will result in serious injury, property damage, or death.



#### WARNING

##### Electrical Shock and/or Fire Hazard

Disconnect power before installation. Turn off all gas to the supply system. Failure to do so can result in serious injury or death.

- Any Installation must be performed by a qualified person in accordance with this instruction manual.
- DO NOT use test pressures higher than 40in-WC (1.45PSI) to test the gas leaks.
- DO NOT attempt to modify the appliance.
- DO NOT alter the appliance for a positive grounding battery system.
- DO NOT move the appliance by grabbing the interior components.
- Make sure all exhaust gases are directed outside the RV.
- Protect all combustible material from the exhaust gases.
- DO NOT draw air for combustion from occupied spaces.



- Always disconnect the 12V appliance (to protect the control from surges that may occur) when performing Dielectric (hi-pot) testing, welding, electrical, and work on the coach.
- Only use with a proven 12V power source such as battery or approved converter.
- DO NOT vent the water heater using a venting system serving another appliance.
- DO NOT install directly into a shower, or near direct heat.
- DO NOT use a battery charger to supply power to the appliance, even when testing.

## Installation location requirements

Select a suitable location for your appliance fixing. The appliance is designed to be installed on a floor or a fixed platform with access to water. Electrical connections are established at the back. Gas access, water inlet, and hot water outlet connections are from the rear also.

The appliance is designed exclusively for installation on an **OUTSIDE WALL** of an RV.



### WARNING

**Risk of poisonous exhaust gases due to improper installation!**















- Make sure that the appliance is installed as described below.

Installation of the alter heater on the back of a trailer is not advised because of high pollution caused by dirty and wet roads.

- DO NOT vent the water heater using a venting system serving another appliance.
- DO NOT install the appliance in any location where the vent may be covered or obstructed when any door on the RV is opened or due to the design of the RV or due to special features of the RV such as slide-out, pop-up, etc.
- DO NOT install on a swing door.
- DO NOT install the appliance in such a way that the cover plate is less than
  - 1 foot from each side and top of any window, slide-out, or opening into the RV.
  - 6 feet from any mechanical air supply inlet
  - 3 feet from any gas tank connection or ventilation.
- Maintain a minimum clearance from combustible materials on sides (4 in), top (4 in), floor (0 in) and rear (0 in).
- Provide room for access to rear of appliance for servicing.



**13** Tools required (not provided)

| Tools   | Description   |
|---|---|
|    | Electric drill  |
|    | Bit size: 1/16"(3mm)<br>Note: It is use for holes drilling of exterior sheet metal of RV.   |
|    | Hole saw size: 3/4"(19mm), for wall controller wires hole opening.<br>Note: It is used for the hole of the wall controller wires perforation. |
|    | Wire stripper pliers  |
|    | Crimping tool   |
|    | Adjustable wrench x 2   |
|    | Tape measure  |
|    | Pencil  |
|   | Phillips screwdriver  |
|  | Flat blade  |
|  | Cutting knife   |
|  | Saw   |
|  | Sealant gun   |
|  | Gloves  |



## Preparing the installation site

- (a) Make sure that the appliance is in contact with the vehicle or a platform with adequate weight-bearing capacity when install.



### CAUTION

#### Sharp edges can cause cuts and injury!

Always wear protective gear such as gloves to avoid injuries from sharp edges during installation work and while handling the appliance.

- (b) To install on a carpeted area, install a metal or wood panel under the appliance that extends at least 3" beyond the width and depth of the appliance.
- (c) If escaping water may damage components or the vehicle, install a collection of the pan below the appliance, direct the flow of water from the pan to outside the vehicle

## Prepare cutout opening

- (a) Make sure that the front edge of the opening is surrounded by a solid frame to firmly anchor the appliance. If needed, build an appropriate frame with the following dimensions:
- Width A = 12.75in.  
Height B = 12.75in.  
Depth C > 20in.

### Installation plan 1

Down edge of the opening is level with the floor.

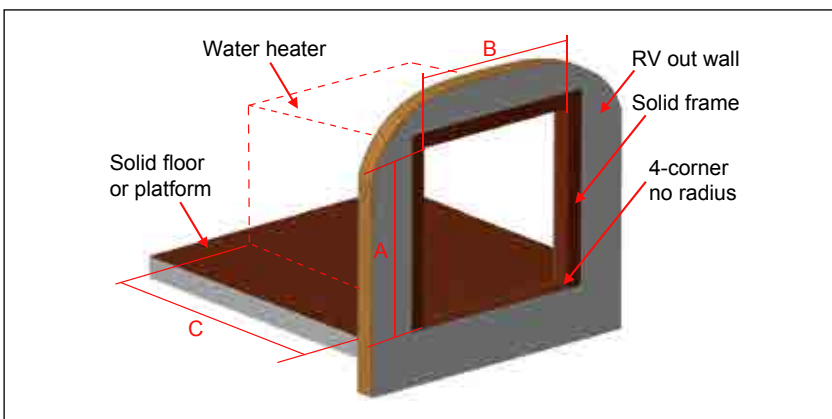

| Cutout dimension on the out wall of the RV |        |         |
|--|--------|---------|
| A  | B      | C       |
| 12.75"                                     | 12.75" | Min.20" |

Note: This cutout size it can replace the Atwood 6-gallon and Suburban 6-gallon tank water heaters.

- (b) The required depth “c” depends on how the water hoses, electrical connection cable, and gas line are installed. The depth “c” must be determined for the particular situation before installation.
- (c) The corners of the rough opening must be at right angles. The exterior wall opening must be the same dimensions with no rounded corners.
- (d) If necessary, create a platform to support the water heater. Below pictures are some common solutions. Ensure the platform is level front to back, and side to side after securing to the RV.

**Installation plan 2**

**Down edge of the opening is higher than flooring with one wooden mat.**

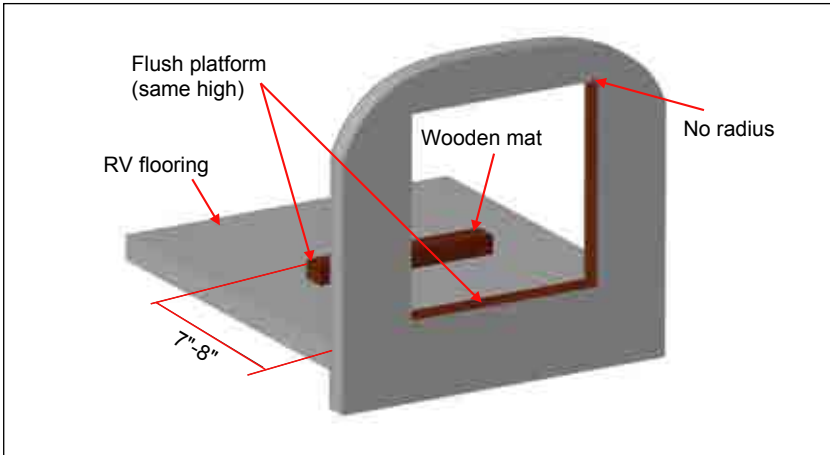



**Installation plan 3**

**Down edge of the opening is higher than flooring with two wooden mat.**

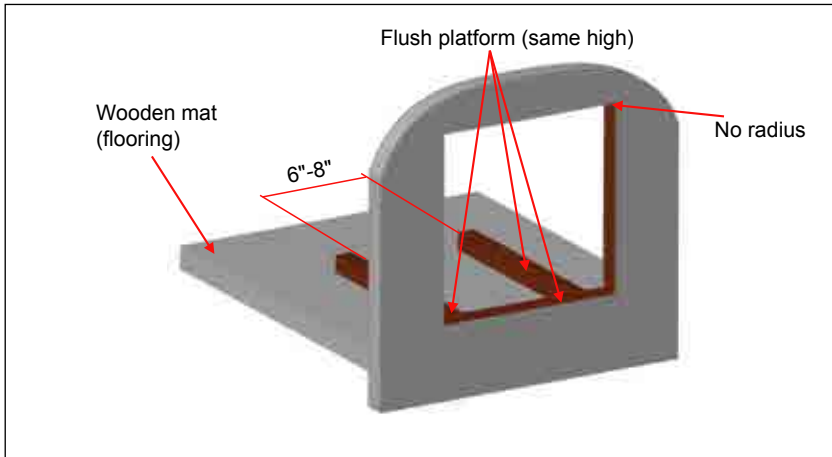

**Check the opening size if suitable for the appliance after finished.**

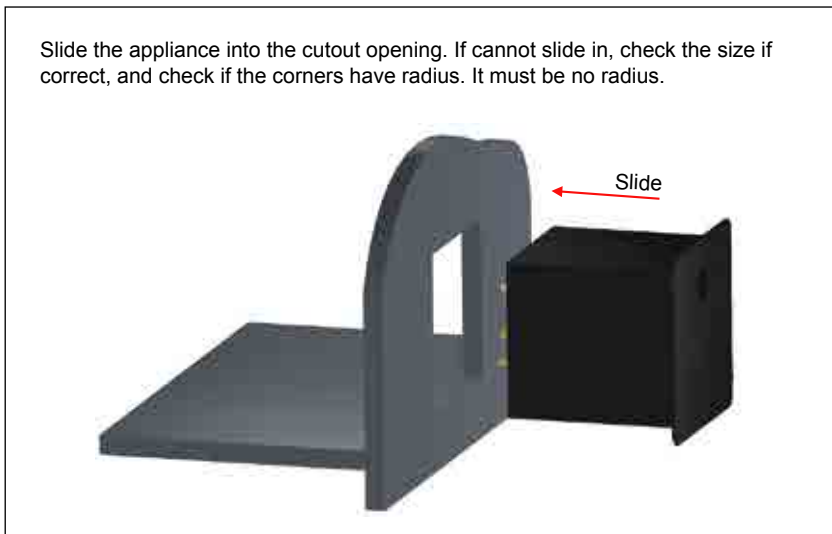

## Prepare utilities

### 1. Gas supply and connection

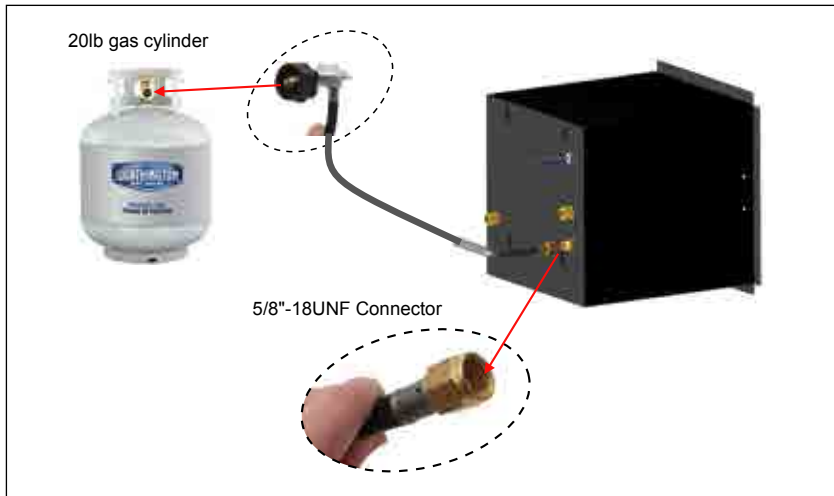

### 2. Gas plumbing

#### DANGER

##### Fire or Explosion Hazard

- Follow all applicable codes, regulations, and instruction material when performing service work.  
Failure to follow instructions will result in product damage, serious injury, or death.
- Fuel entering the appliance must be in the gas phase, the liquid phase must not be used, and will result in damage to the product.
- This appliance is rated for 65,000 BTU/HR, 11~14in-WC. (2740~3490Pa). Follow NFPA1192 and Z240 RV series for proper pipe sizing based on additional gas-burning appliance loads.
- Use with LP gas (propane) only. Butane or any mixtures containing more than 10% butane must not be used.
- The gas line must terminate with a  $\frac{3}{8}$ " flared female compression fitting to connect with the rear gas connector of the appliance.
- A non Metallic Flexible gas hose must be rated for 149°F (65°C). Anchor appropriately to prevent fatigue and failure from wear edges.



- Make sure that the operating pressure of the gas supply corresponds to the operating pressure of the appliance 11~14in-WC (2740~3490Pa).
- (a) Locate the entry point for the plumbing to service the rear of the appliance. Ensure the entry point is not in the footprint space of the appliance.
- (b) Feed gas line into proximity, leave enough length to flex into position so that when connected no kinks are created.  
NOTE: An approved semi-flexible metallic pipe is acceptable to connect as an extension from the gas line to the appliance.
- (c) Terminate gas line with fittings to connect to the appliance.

### 3. Water plumbing

The water plumbing system must be rated to supply between 35-70PSI nominal. Connections can be made using PEX swivel nut adapters with NPT straight thread and a cone seal or with a standard 1/2" FNPT fittings. If use a standard 1/2" FNPT fittings for connection, we suggest you to buy a joint with bottom face seal (refer to below right side picture), if not, you should buy some Teflon taps for sealing.

### 4. Fittings for water inlet and outlet

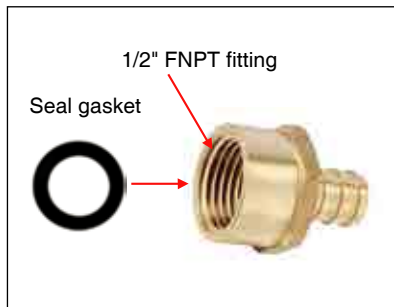

## 5. Water plumbing for RV water heater

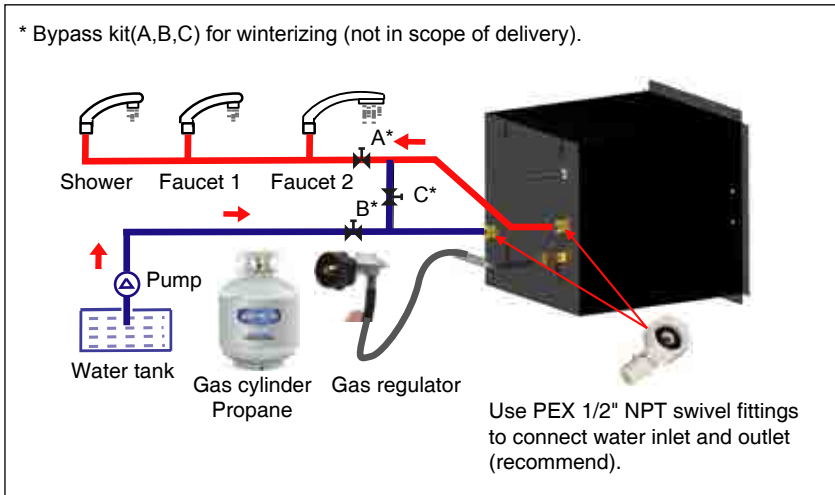

## 6. Wires connection cautions and diagram

**⚠ WARNING**

**Electrical shock hazard**

- Disconnect all power before performing any work.
- Always use a certified and proven 12V isolated power supply, that is properly grounded to the RV.
- Follow all applicable codes, regulations and instruction material when performing service work.
- Failure to follow instruction could result in serious injury or death.

- Wiring connected to or in proximity of the appliance must be rated for 140°F (60°C) minimum.
  - Use only insulated terminals for all electrical connections.
  - The appliance requires a power source that can adequately provide 10~17V DC to function properly.
- (a) Select a distribution branch greater than 3A, preferably 15 amp, to provide nominal 12V to the appliance from the distribution panel.

**NOTE:** The appliance has a built in 10A fuse, serviceable from the front of the product. The appliance can be on a dedicated or shared branch circuit with the same or higher rating.



**Optional:** A power switch can be placed in the living quarters for convenience, but not required as a switch is located externally on the appliance. If the switch is fused, make sure it is rated for at least 3 amps.

- (b) Locate entry point for the wiring to service the rear of the appliance. Ensure entry point is not in the footprint space of the appliance. Make sure any edges are protected to prevent wire abrasion from occurring.
- (c) Determine the appropriate wire gauge (AWG) for the 12V power supply length. Ensure enough wire is available to make adequate connection.
  - 16AWG max. 40 feet
  - 14AWG max. 66 feet
- (d) Feed wire from power source to the entry point. Make connection to the power source.

### Electrical wiring diagram

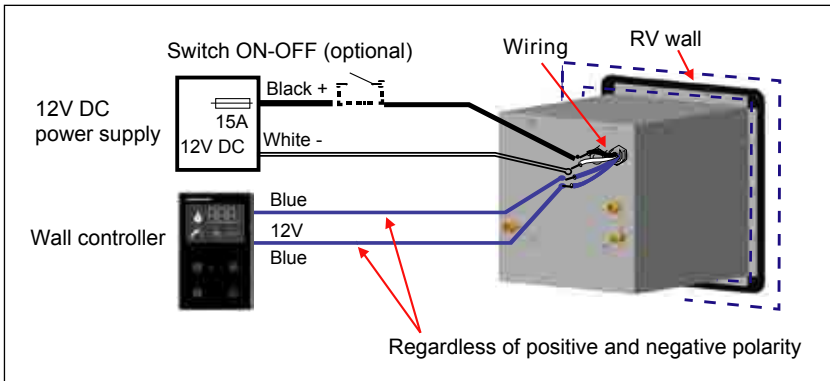

### 7. Prepare for Wall Control

- (a) Determine a location to install the wall controller inside the RV.
- (b) Drill a  $\frac{3}{4}$ " hole and clean edges.
- (c) If necessary, run two electrical wires that extend the wall control connections (blue wires) to the appliance. Connections (blue wires) using the appropriate wire size. 16AWG max. 65ft.



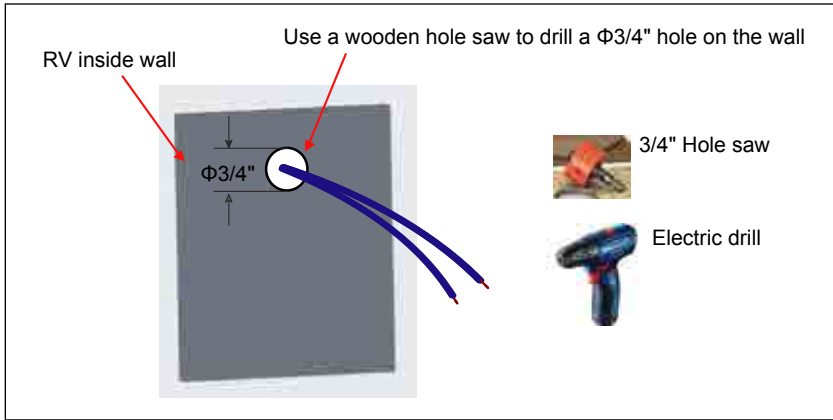

## Appliance installation steps

Step 1: Unpackage and remove protective caps from the joints.

1. Unpacking the box and lifting appliance upward until fully removed from the box.
2. Remove protect caps of the water inlet, water outlet and gas inlet joints.  
Refer to below pictures.

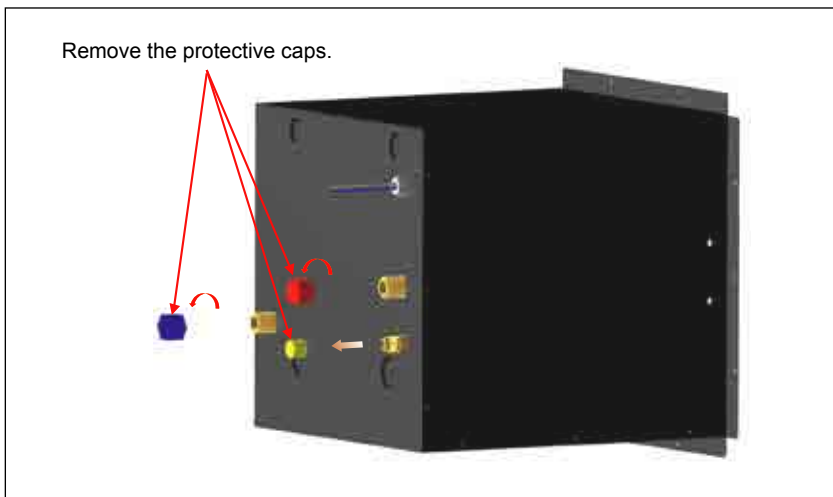

Step 2: Apply the butyl tap on the backside of the flange.

Apply adequate water sealing material, e.g. butyl tape (recommended width: 1", not provided), around the entire backside of the flange area and holes.

NOTE: Do not use adhesive sealing material e.g. silicone for the watertight seal.

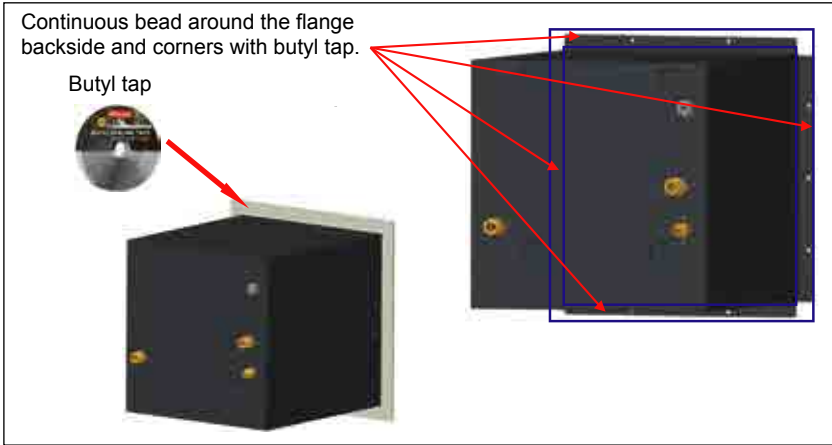

Step 3: Slide in appliance.

1. Position the water heater carefully insert the frame opening , evenly space the flange to the exterior wall of the RV.

NOTE: Ensure area beneath and behind the appliance is clean without debris and obstruction.

Carefully slide the water heater across the floor to prevent linoleum damage.

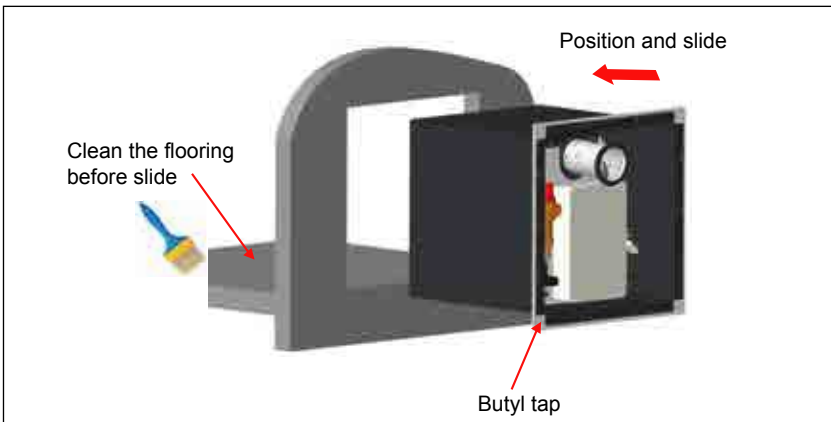

Step 4: Check and adjust the position after slide.

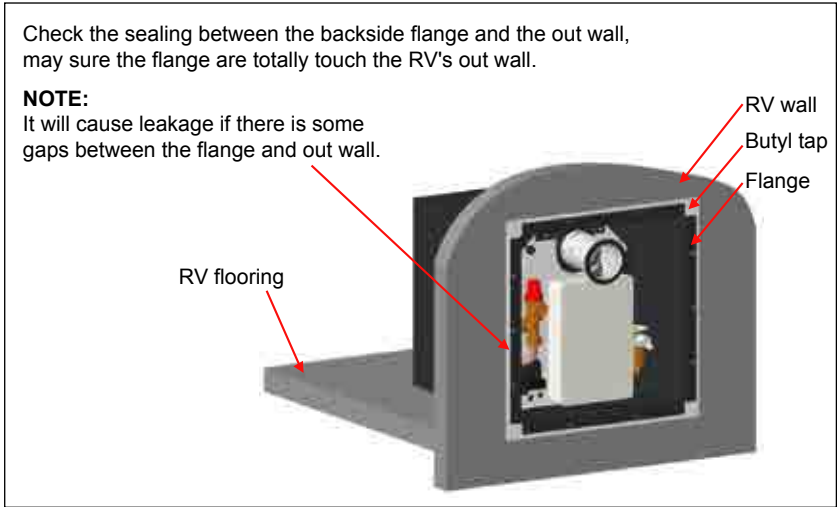

Step 5: Gas inlet, water inlet and water outlet connection.

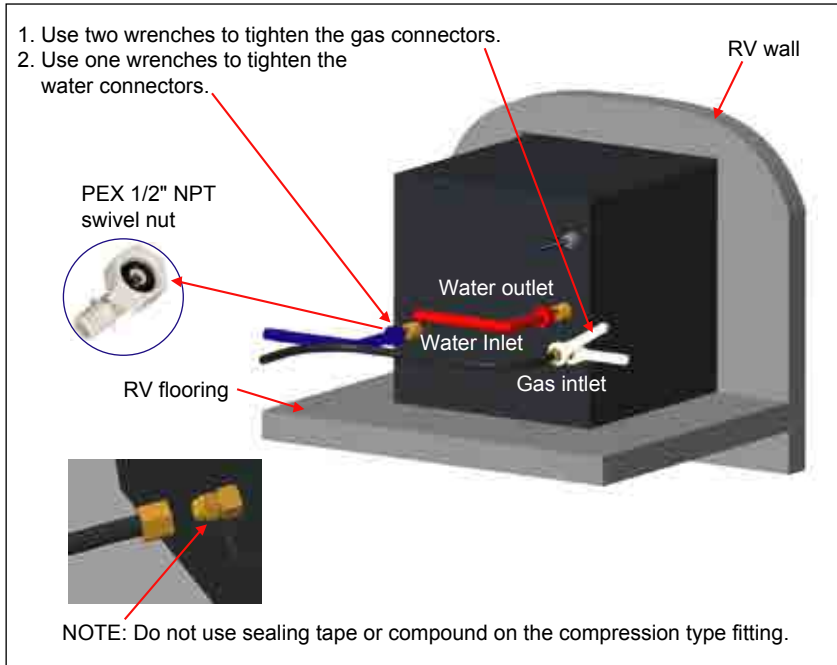



Step 6: Wires connection.

Connect the wires with wire connectors.

- 1. Black wire to black wire(+)
- 2. White wire to white wire(-)
- 3. Blue wire to blue wire(controller)
- 4. Blue wire to blue wire(controller)

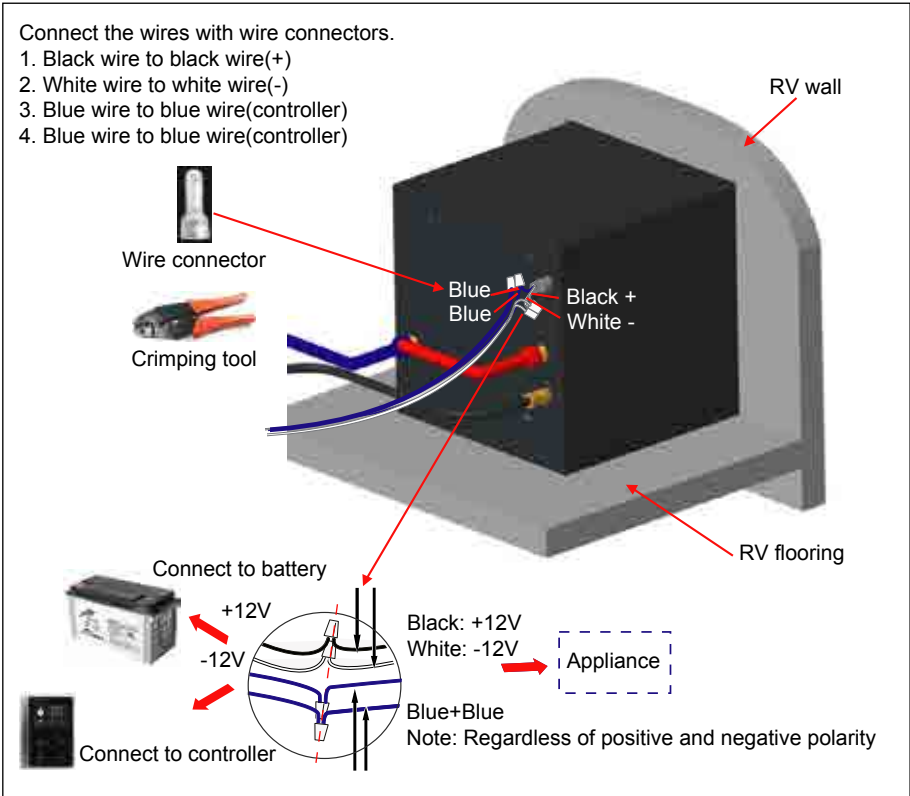

Step 7: Door frame installation.

- 1. Unpack the door assembly from the package.



- 2. Lift the handle of the door lock by finger.



3. Rotate the handle 90 degrees angle.



4. Open the door.



5. Pull out the baffle before installation.

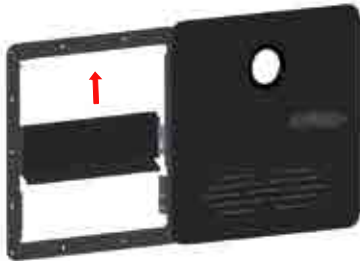

6. Pre-install the door frame and make sure each hole is aligned to the flange hole.

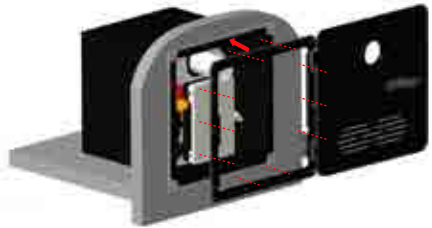

7. Mark four dots with a pencil for drilling.

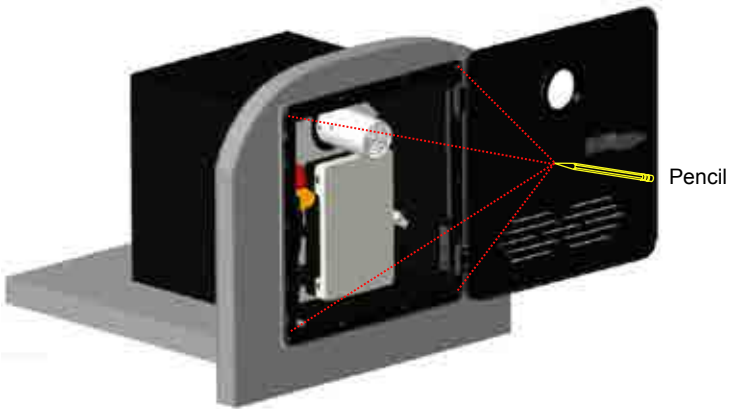

8. Drill 14 holes on the metal board of RV out wall with 1/8"(3mm) bit.  
 \* Note: Drill the metal board only, no need to drill the inner wooden or heat insulation layer.

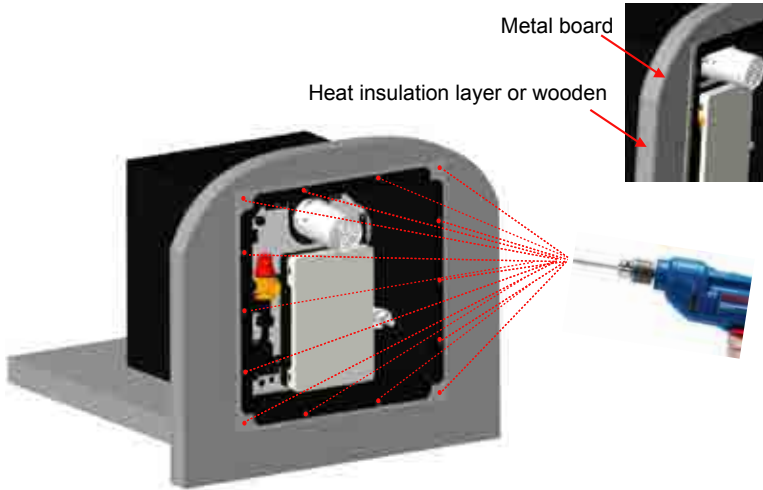

9. Fixing door frame with ST3.9\*30 mm self screws(14Pcs).

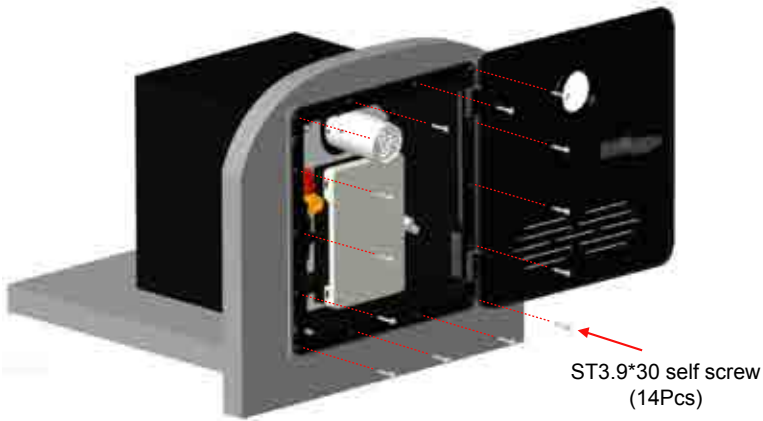

10. Apply sealing material at the adage of the door frame(for better waterproofing).  
Remove excess sealing material after sealling.

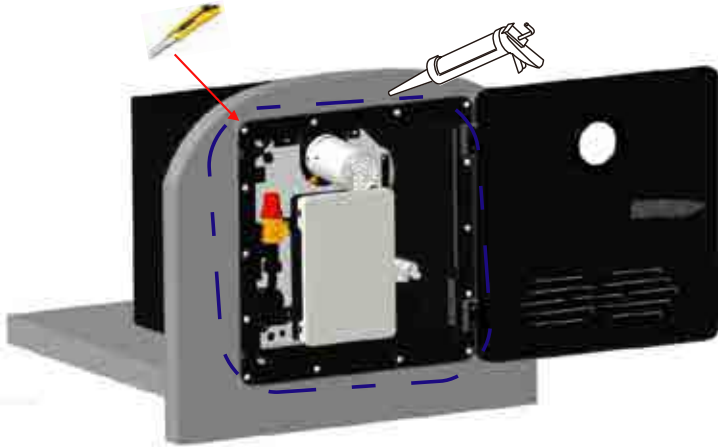

## Wall controller installation steps

Step 1: Disassemble the wall controller.

1. Press and push up the buckle of the wall controller.



2. Open the cover by finger or by flat blade .



Step 2: Install the back cover of the wall controller.

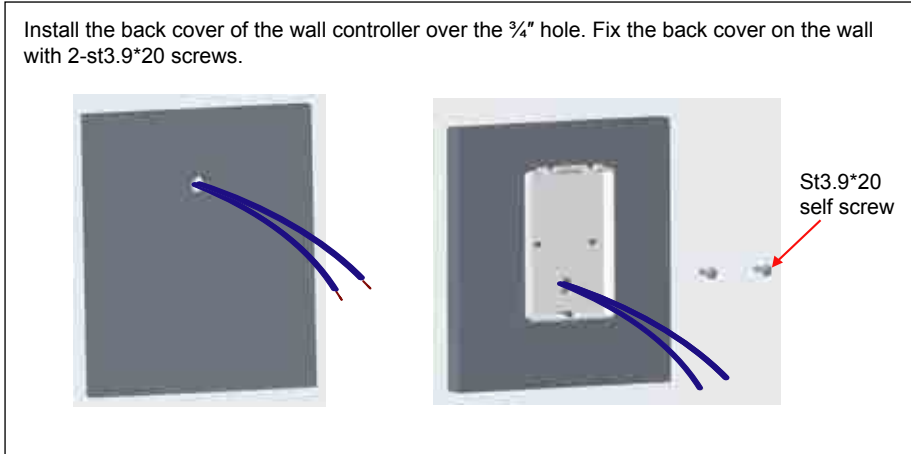

Step 3: Wires connection.

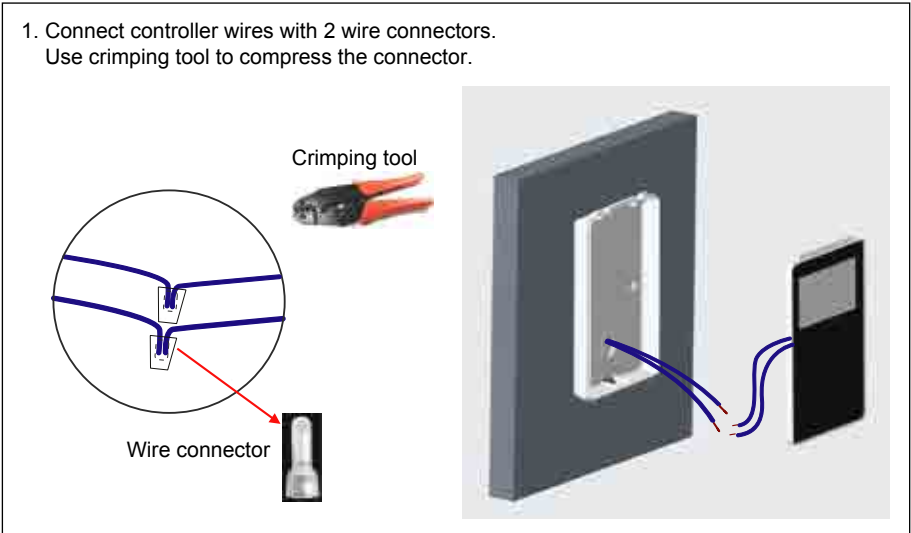

Step 4: Assemble the controller cover.

1. Assemble the cover again after fixing the back cover.

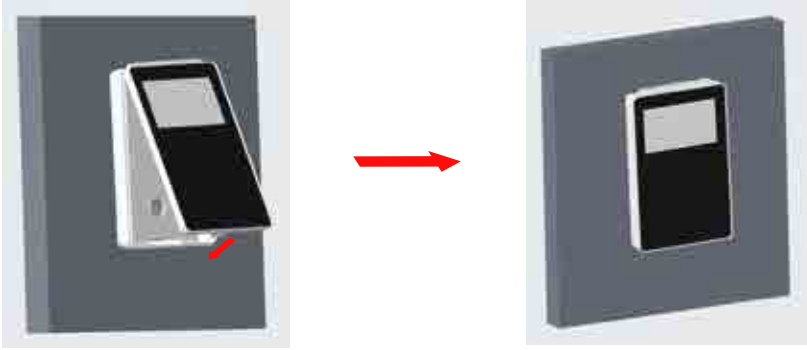

## Wiring Diagram

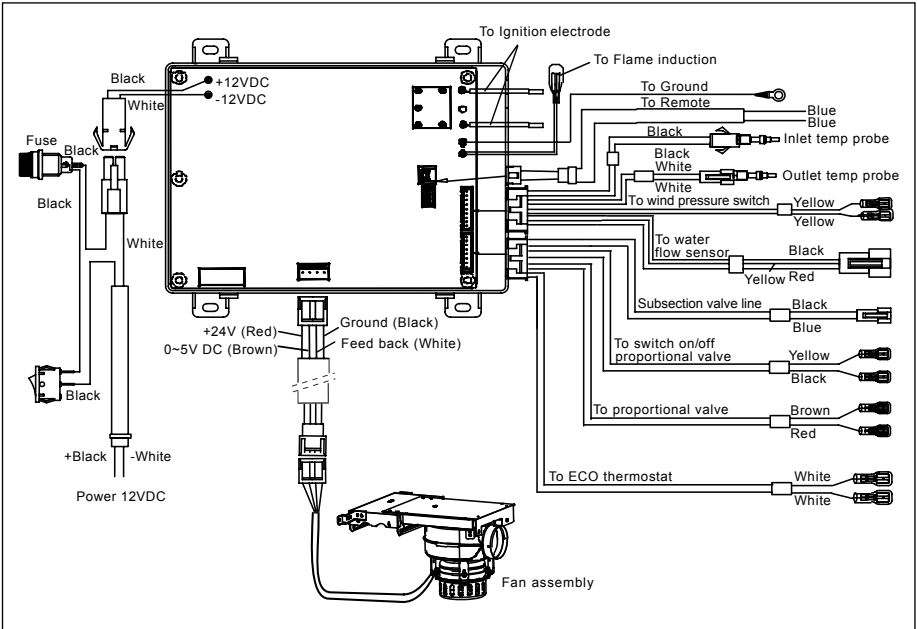

# Check After Installation

## Checking for gas leak



### WARNING

#### Risk of death and personal injury through fire and/or explosion!

- DO NOT use matches, candles or other sources of ignition when checking for gas leaks.
- After the gas supply is connected, check for gas leaks at all gas connections. Use a gas leak detection liquid or equivalent. Ensure test pressure are below 40 in.wc (100kPa)
- Make certain to re-test all fittings after making adjustments to loose connections.
- Failure to follow instruction may lead to serious injury, property damage or death.

1. Verify the power switch on the water heater is in the “OFF” position.
2. Turn on the gas supply or alternative pressure supply.
3. Check the appliance and all gas connections for gas leaks with leak detection liquid (not provided) or an equivalent gas leak detection method. Bubbles indicate a gas leak that must be repaired.
4. Repair gas leaks as needed.
5. Repeat gas leak check after any adjustments to loose connections.



Bubbles indicate gas leak

**NOTE:** After leak checking, make sure the gas supply pressure corresponds to the operating pressure of the appliance 10.5~14 in.WC (2620Pa~3490Pa).

## Checking for water leak

1. Verify the power switch on the water heater is in the “OFF” position.
2. Turn on the water supply to the appliance.
3. Open water faucets to fill the system with water. Close the faucets when the water is flowing smoothly and all air is removed from the lines.
4. Check all connections for water leaks by eye and touch.
5. Repair water leaks as needed.
6. Repeat water leak check after any adjustments or loose connections.



## Functional check



### WARNING

#### Fire or explosion hazard

- Ensure all necessary system leak tests are complete before operation any functional test.
- Failure to follow instruction could lead to serious injury, property damage or death.

### Prepare

1. Verify the power switch is in the "OFF" position.
2. Confirm that there is a "steady" water flow (not pulsating) and no air in the system. If pulsating have the water pump settings adjusted.
3. Make certain all valves that can mix cold and hot water are all shut.

**Note:** Outside faucets with detachable spigots and shower heads with flow interrupters can bleed hot water into the cold side if the valves are not closed properly. This will hinder the performance of the water heater.

### Start to work

1. Turn the power switch to the "ON" position on the appliance and verify the wall controller is illuminated. If the wall controller is not illuminated, press  button on the wall controller to illuminate. The controller display will show the hot water temperature.

**Note:** The default factory setting is 115°F or 46°C.

2. Turn on the gas supply.
3. Open a hot water faucet and verify that the unit ignites and supplies hot water at the faucet.
4. The wall controller display will show the current temperature settings.

**Note:** If any error codes or performance concerns, refer to the troubleshooting section of this manual.

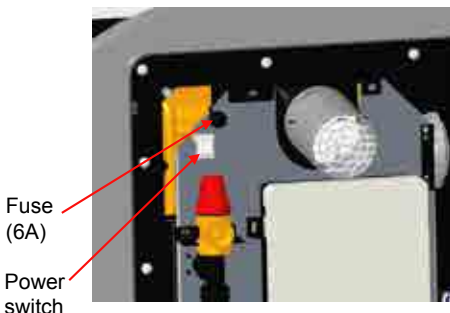



# Operation Instruction

## Controller operation

Before normal operation of the appliance, perform a basic functional test check out each time the RV and water system is setup for use (May sure electric, water and gas supply are normal).

1. Touch to turn on the power, the display will show current temperature setting.
2. Touch button will transform the temperature display in °F or °C, please see below picture.
3. Touch button to adjust the temperature to your desired settings. The wall controller settings are from 95°F (35°C) to 124°F (51°C) ). The default setting temperature from factory is 108°F (42°C).

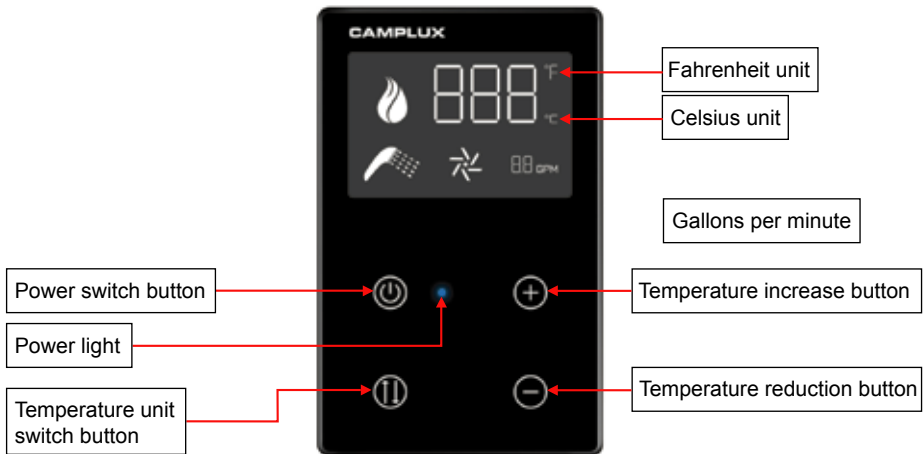

## Water flow control

1. The appliance is equipped with a water flow control valve in the right side, it set from the factory at max flow. The valve will reduce the water flow and capacity through the water heater to improve water heating performance. Under extreme conditions, it may be necessary to adjust the valve accordingly:
  - Cold water inlet conditions approximately less than 41°F (5°C)
  - Higher water inlet pressures > 65 PSI.
  - Reduce water flow: Rotate knob clockwise until a solid stop.
  - Increase water flow: Rotate knob counter clockwise until a solid stop.



1. Pull out the baffle from the door frame.

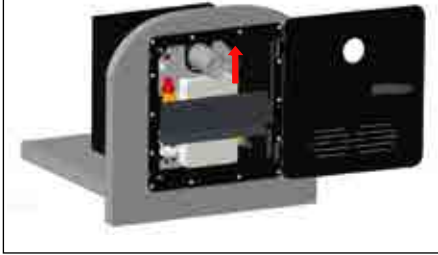

2. Adjust the water regulator.

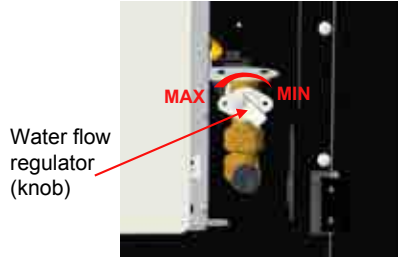

### Safe operation



#### WARNING

##### Scald hazard

- Never let infants, children, elderly adjust the water temperature or be left unsupervised when using hot water.  
Failure to follow instruction may lead to serious injury.

Consider the following points for safe use of the appliance:

1. Install an RV water regulator to the inlet of the coach, and operate between (35-70PSI) water pressure.
2. The factory default water temperature setting is 108°F (42°C).
3. There may be a variation between the temperature delivered from the appliance and the temperature at the faucet due to water conditions between seasons like hot summer or the length of pipe from the appliance.
4. Always check the water temperature, in reference to the chart below, by the display and hand touch before bathing or with other hot water uses.

| Temperature °F (°C) | Time before skin becomes scalded |
|---------------------|----------------------------------|
| 155 (68)            | 1 Second                         |
| 148 (64)            | 2 Seconds                        |
| 140 (60)            | 5 Seconds                        |
| 133 (56)            | 15 Seconds                       |
| 127 (52)            | 1 Minute                         |
| 124 (51)            | 3 Minutes                        |
| 120 (48)            | 5 Minutes                        |
| 100 (37)            | Safe Bathing Temperature         |

Source: Moritz, A.R. / HERRIQUES, F.C.: Studies of thermal injuries: the relative importance of time and surface temperature in causation of cutaneous burns A. J. Pathol 1947; 23: 695 - 720.



## For high altitude use

This appliance can be used at high altitude and has been tested up to 2000ft. For prolonged use at higher altitudes please contact [support@camplux.com](mailto:support@camplux.com).

## Cleaning and maintenance



### WARNING

#### Burn or scald hazard

- Never perform work while the water heater is operating.
- Never perform work without turning the Electrical and LP gas supply off.
- Never perform work when the appliance is hot.
- Never actuate the pressure relief valve as long as the appliance is still hot.
- Never actuate the Drain Plug as long as the appliance is under water pressure and/or is still hot.



### CAUTION

#### Sharp edges can cause cuts and injury

- Always wear protective gear such as gloves to avoid injuries from sharp edges during installation work and while handling the appliance.

## Winterizing Operation

### Winterizing water heater



### CAUTION

#### Product damage due to frost condition ❄️

- In frost conditions, ambient temperatures below 39°F (4°C), there is a risk that water in pipes, faucets and appliance could freeze. This can cause considerable damage.

### Automatic winterizing:

The appliance is equipped with an Automatic antifreeze device. When the water temperature drops to 43, the appliance will start to work, until the water temperature reaches 90, the appliance stops working. This is a cycle work.

Consider the following points for safe use of the appliance:



**Note:** The appliance electric supply and gas supply must be turn on, and the controller can be turn off (in standby). If the electric and gas supply not provided, the automatic winterizing device will not not work.

**Manual winterizing operation:**

To winterize the appliance for a long time or for storage, you must drain all water from the appliance. To do this we advise the following steps:

**Winterizing the RV by draining water:**

1. Close valves A and B, open valve C at the back of the appliance.

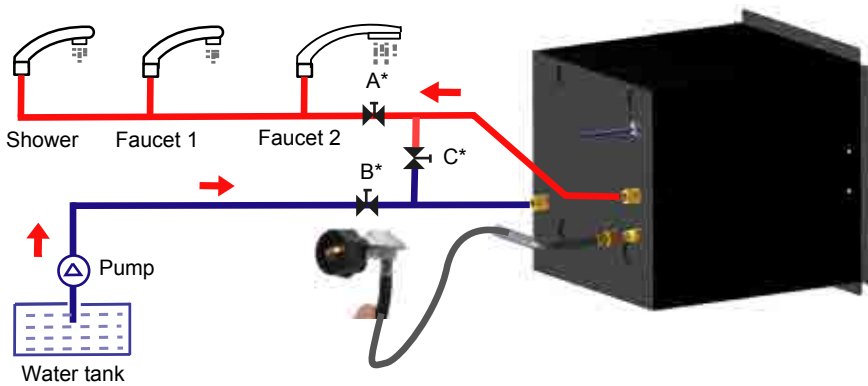

2. Open the door and pull out the baffle from the door frame.



3. Unscrew the water inlet filter and drain plug by hand or flat-blade screwdriver. Let water completely drain from the appliance (If needed, clean the filter).

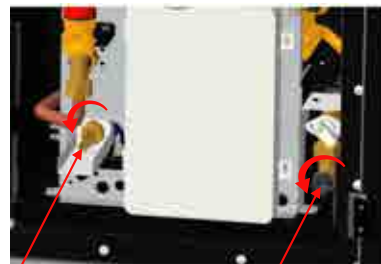

Drain plug

Filter



4. sure the water in the appliance has totally drained. Then screw the drain plug and the filter again.

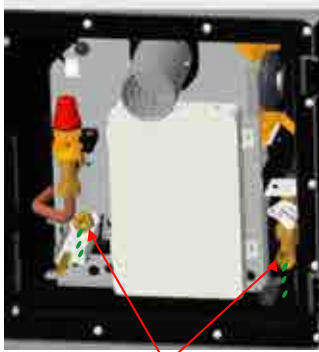

Water draining

5. Flush the RV's water system with a suitable winterizing fluid according to the supplier's or RV manufacturer's guidelines.

**Note:** Once the water has been drained, the appliance is protected against freezing conditions.

### Winterizing the RV with a winterizing fluid:

⚠ Winterizing the RV with a winterizing fluid is only possible with an installed by pass kit (not in scope of delivery).

Follow the instructions provided by the RV coach manufacturer for winter your water system.

Supplement the following important water heater instructions when completing any winterizing steps:

### Compressed air pressure for blowing water heater:

- DO NOT exceed 30PSI when air pressure into the water heater.  
While completing the blow out process for the entire water system, take time to isolate the water heater by closing all drain plugs and faucets and only open the water heater drain plug and filter cover. This ensures maximum pressure and flow is isolated through the water heater for complete evacuation.

### Anti-freeze:

- Use a non-toxic antifreeze recommended by the RV coach manufacturer.
- Anti-freeze can be used directly in the water heater, plan for an additional 1L to fill the system.

### Optional:

A bypass valve can be installed or used to bypass filling the water heater with antifreeze. The water heater must be evacuated with compressed air (see steps above) before bypassing.



## Storage and transit

Anytime the RV is not intended to be used, it is considered to be in storage or transit. To prepare the water heater, follow the below steps:

1. Turn off gas supply.
2. Turn off water heater main switch.
3. Drain water out of the system and water heater by removing the filter cover and drain plug. If freezing conditions could occur, then winterize according to "Winterizing Water Heater" (Refer to above operation).

## For next season using

- Thoroughly flush the water heater and system with clean drinking water through the hot and cold side before using. Drain water several times out of the water heater drain plug. Sanitize the water system per the recommendations of your coach manufacturer.

## Routine inspection

Routine inspection is critical for maintaining proper operation of your appliance. Unless specified, review the following items yearly or before each season:

1. Inspect the gas system, water system and installation every two years, or otherwise specified by your RV coach manufacturer, by a qualified person.
2. Inspect for cracks, separation, peeling of seals to the RV wall. Remove and re-seal as necessary (caulking or tape) between the side wall and the door of the water heater and ensure that the unit is solidly mounted to the vehicle.
3. Before actively using your vehicle, pre-inspect that the air intake openings (louvers) are completely open and clear of any debris including mud, leaves, twigs, insects, etc... Remove all obstructions to allow full air flow.
4. Before actively using the vehicle, open the door and verify that no debris or extraneous combustible materials are present anywhere (especially in the area of the burner and the gas controls). Remove any item present and wipe clean the bottom of the housing.
5. Before actively using the vehicle, verify that the exhaust tube and screen are completely clear of obstructions including: mud, leaves, twigs, insects, nest, etc. Clean by gently breaking up and using a vacuum to clear it. Use only water and apply gently from a spray bottle, Never spray directly with high pressure water. Run the appliance to dry any moisture and blow out loose debris. The use of any aftermarket protective screen is prohibited and will void the warranty.
6. Inspect the interior surface of the housing for any cracks or corroded areas that could allow penetration of gases into or out of the interior of the vehicle. Check especially around the hot water, cold water, gas and electrical connections.



**Note:** If damages found, please contact a technician to repair or contact Camplux customer service.

7. Check that all wire connections are firmly in place and there are no signs of chafing or cracks on the insulation. Verify that the spark ignition cable between the Control Board and the igniter is securely in place and not shorted to any metal component.

8. Inspect the pressure safety valve to ensure it has not been leaking (no water residue). See "Pressure Safety Valve Maintenance" for further inspection.

9. Inspect/clean/replace water inlet filter as necessary, use a brush to clean the filter.



Safety valve

1. Unscrew the filter.



2. Pull out the filter.



3. Clean the filter with brush.



## Pressure safety valve maintenance



### WARNING

#### Burn or scald hazard

- Never actuate the pressure relief valve while the appliance is in operation.
- Never tamper with the pressure relief valve.

1. The unit is equipped with a water pressure safety valve. The pressure safety valve needs to operate once each year to ensure this safety device is effective.
2. The pressure relief valve is a safety component and must not be removed for any reason other than replacement.

**NOTE:** The pressure relief valve must be replaced by a certified service technician if defective.



3. Tampering with the pressure relief valve will void the warranty.
4. Rotate the pressure safety valve handle (Red) about 5 times counterclockwise to check if has some water dripping from the pressure safety valve.

Pressure safety valve handle

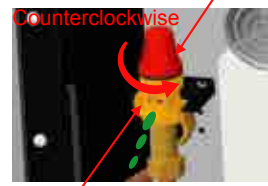

Dripping water

## Hard water and decalcification

For prolong usage, when exposed to higher water hardness concentrations, it is advised to provide a proper water treatment device for the incoming water to the coach. Hard water may lead to performance reduction of you appliance overtime. Contact camplux for decalcification instructions.

### Recommended decalcification frequency per year

|  |                         |     |        |      |
|--|-------------------------|-----|--------|------|
| Water hardness<br>mg/l CaCO <sub>3</sub> | Very hard: >180         | 1   | 2      | 4    |
|  | Hard: 121-180           | 1   | 1      | 3    |
|  | Moderately hard: 61-120 | 1   | 1      | 2    |
|  | Soft: 0-60              | 1   | 1      | 1    |
|  | <b>Use*</b>             | low | normal | high |

## Troubleshooting

### Error Code

If the appliance malfunctions, a beep alarm will sound and the error code will display on the wall controller. Write down code, then try resolving by stopping and restart the water flow several times, or resetting the appliance as follows:

- Switch the power switch in front of the water heater to the “OFF” position (Need to open the water valve and shower).
- Wait 5 seconds.
- Switch the appliance on again.
- Continue to use the appliance normally. If error fault codes continue to display, review the following table for potential causes.





| Error Code  | Possible cause   | Solution  |
|---|--|---|
| E0: Water outlet temperature sensor fault                 | Temperature sensor or system failure.                      | Check the water outlet temperature wires connection if loosen, tighten it. If not, maybe outlet temperature sensor failure, replace it.                                       |
| E1: Flame sense fault                                     | Insufficient fuel supply to start operation.               | Confirm all gas valves are open, and restart the appliance 4-5 times (First time for using).<br>Confirm adequate fuel in tanks.   |
|   | Low gas inlet pressure.                                    | Check regulator for operation, replace if needed.   |
|   | Flame sensor or system failure.                            | The flame sensor induction or PCB board is broken, need to be replaced one of them.   |
| E2: Detected fake flame signal                            | Flame sensor or system failure.                            | PCB main control board failure or program faulty. Replace main control board.   |
| E3: Over temperature mechanical sensor fault              | Thermostator system fault.                                 | When E3 error displays, let cold water flow 10~20S then restart the appliance. If E3 still displays, check the water flow if too low, if not, check the thermostat if broken. |
| E4: Water inlet temperature sensor fault                  | Temperature sensor or system failure.                      | Check the water outlet temperature wires connection if loosen, tighten it. If not, maybe outlet temperature sensor failure, replace it.                                       |
| E5: Air pressure fault                                    | Exhaust Blockage.  | Remove obstruction, then restart the appliance.   |
|   | High winds blowing on exhaust.                             | Move or re-orient coach soexhaust is not facing high winds, then restart the appliance.   |
|   | Air switchorfan Fault.                                     | Check the air switch or fan if broken.  |
| E6: Temperature Surge alarm                               | Cold water surge in system.                                | Reduce toilet flushes and amount of cold water faucets opened during operation.   |
|   | Cold water mix ratio.                                      | Reduce temperature setting to reduce cold water mix ratio.  |
|   |  | Check for shower head and outdoor faucet valves leaking cold water to hot side.   |
|   | Insufficient water supply.                                 | Confirm water tank is full or city water valve fully open.  |
|   |  | Air in water lines-continue to run all faucets, hot and cold, open until air purged.  |
|   | Insufficient water flow.                                   | Filter plugged- review "Cleaning and Maintenance" section of this manual.   |
| Low flow faucets - check that the minium flow is 0.32gpm. |  |   |
| Temperature sensor or systemfault.                        | Replace the out let temperature or main PCB control board. |   |
| E7: Solenoid valve fault                                  | Solenoid valve or system fault.                            | Check the solenoid valve wires connection if loosen or broken.  |



## Troubleshooting

- If you encounter a problem with the appliance as the below table states, first try the suggested solutions. If problems persist, please call the camplux service or the dealer.
- Don't repair the appliance by yourself, repairs must be performed by a certified service technician.

| Problem                                     | Potential cause   | Solution   |
|---|---|--|
| No hot water at the tap                     | Gas supply is turned off or interrupted.  | Check and/or turn on gas supply.   |
|   | Gas tank is empty.  | Refill/replace the gas tank.   |
|   | The appliance is switched off.  | Switch on the appliance according to instructions ("operating procedures" on page 11).   |
|   | Water supply is turned off.   | Open the water supply.   |
|   | Power supply to the appliance is switched off.  | Switch on power supply to the appliance.   |
|   | Defect in the appliance.  | Refer to error codes list.   |
| Hot water takes longer to reach temperature | <ol style="list-style-type: none"> <li>1. Cold water mixing into hot water side</li> <li>2. Higher elevation</li> <li>3. Incoming water temperature is abnormally low.</li> </ol> | <ol style="list-style-type: none"> <li>1. Check all valves, inside and outside, to ensure they are closed, check shower head valve to make sure it is not partially closed.</li> <li>2. This is normal due to lesser oxygen levels - Contact camplux service.</li> <li>3. See "Water Control Valve" for adjustment.</li> </ol>                 |
| Hot water temperature too low               | Gas flow to the appliance is too low (gas inlet pressure 11in. WC).   | <ul style="list-style-type: none"> <li>• Consult vehicle documentation to determine if gas supply is capable of providing the necessary volume of gas for the appliance.</li> <li>• Contact a service technician to verify a suitable gas installation.</li> </ul>   |
|   | Volume flow of hot water is too high and/or the temperature of cold water reaching the appliance is too low.  | <ul style="list-style-type: none"> <li>• Turn down hot water at the tap or in the shower in order to reduce volume flow. Or mix more cold water in faucet.</li> <li>• Potentially retrofit a volume flow throttle into the water system. This must be performed only by a certified service technician.</li> </ul>                             |
|   | Too much lime scale in the appliance.   | Decalcify your water heater. See "Cleaning and Maintenance" section.   |
|   | Cold water mixing into Hot water side.  | Check all valves, inside and outside, to ensure they are closed. Check shower head valve to make sure it is not partially closed.  |
| Water escaping at pressure safety valve     | Water pressure in water system too high.  | <ul style="list-style-type: none"> <li>• Adjust the water pump pressure to a maximum of 65PSI.</li> <li>• If the water system is connected to a central water supply higher than 65PSI (rural or urban connection), a water pressure reducer must be used.</li> <li>• Install a water pressure regulator at the fresh water supply.</li> </ul> |



|  |  |   |
|--|--|---|
|  | Lime or dirt under the pressure relief valve seat.                       | <ul style="list-style-type: none"> <li>• Allow the appliance to cool then slowly operate the relief valve by rotating its valve handle (knob), Fig.36) to flush the water system and attempt to force dirt or foreign matter out of the pressure relief valve seat.</li> <li>• Replace pressure relief valve. This must be performed only by a certified service technician.</li> </ul> |
| Water leaking at the water inlet filter                                  | Lime or dirt under the O-ring seats.                                     | Clean the O-rings and their corresponding sealing surfaces with clean water.  |
| Water heater stops working often and water is found on the drainage tray | Unit is over heating, and pressure relief valve discharged periodically. | Contact camplux service.  |
| Power status LED is off although an operating mode was selected.         | Power supply to the appliance is switched off.                           | Switch on power supply to the appliance.  |
|  | Blown fuse.  | Switch the standard 125V/10A fuse. Contact camplux service.   |



# CAMPLUX



8350 Patriot Blvd STE B, North Charleston, SC 29420

1(844) 538-7475

support@camplux.com

Visit Us: [Camplux.com](https://www.camplux.com)

**CAMPLUX**

