



marey®

GA14CSALP | GA14CSANG

GAS TANKLESS WATER HEATER

Installation and Operation Manual

WARNING:

If the information in these instructions is not followed exactly, a fire or explosion may result causing property damage, personal injury or death. Do not store or use gasoline or other flammable vapors and liquids in the vicinity of this or any other appliance.



WHAT TO DO IF YOU SMELL GAS:

- Do not try to light any appliance.
- Do not touch any electrical switch; do not use any phone in your building.
- Immediately call your gas supplier from a neighbor's phone.

Follow the gas supplier's instructions. If you cannot reach your gas supplier, call the fire department.

Installation and service must be performed by a qualified installer, service agency or the gas supplier.

📞 USA (855) 627-3955

🌐 www.Marey.com

📞 PR (787) 727-0277

Contents

INTRODUCTION AND SAFETY WARNINGS

INTRODUCTION	3
IMPORTANT SAFETY INSTRUCTIONS	3
SAFETY WARNINGS	4

OPERATION

DESCRIPTION OF OPERATION	6
OPERATING INSTRUCTIONS	7
EXTENDED SHUTDOWNS	13
COLD WEATHER WARNINGS	15
MAINTENANCE AND INSPECTION	16
TROUBLESHOOTING	19
DIAGNOSTIC CODES	22

INSTALLATION

INSTALLATION GUIDELINES	25
PACKING LIST	26
LOCATION AND CLEARANCE REQUIREMENTS	27
TYPICAL INSTALLATION	27
MOUNTING	28
ELECTRICAL	29
GAS PIPING	31
GAS PIPING	32
AIR INTAKE AND EXHAUST (VENT) SYSTEM	33
START UP AND TESTING	38

REFERENCE

WIRING DIAGRAM	40
SYSTEM SPECIFICATIONS	42
DIMENSIONS	43
NAMES OF MAJOR PARTS AND COMPONENTS	43
SPARE PARTS	44
LIMITED WARRANTY	45

IMPORTANT: KEEP THIS MANUAL FOR FUTURE REFERENCE!

INTRODUCTION AND SAFETY WARNINGS

INTRODUCTION

Thank you for purchasing a Marey Gas Tankless Water Heater. In order to ensure proper installation, safe operation, and long life, please carefully read these instructions. Installation should only be completed by licensed professionals. Use of a professional ensures the installation is in full compliance with all required building, plumbing and electrical codes.

KEEP THIS MANUAL for future reference. This booklet includes useful information about the product, maintenance requirements and the details of your product warranty.

IMPORTANT SAFETY INSTRUCTIONS



READ AND FOLLOW ALL INSTRUCTIONS.

When using this equipment, basic precautions should always be followed.

Safety Definitions



This symbol is the safety alert symbol which is used to alert you to potential hazards that can kill or hurt you and/or others.

	Indicates an imminently hazardous situation which if not avoided will result in death or serious injury.
	Indicates a potentially hazardous situation which if not avoided could result in death or serious injury.

 **CAUTION**

Indicates a potentially hazardous situation which if not avoided could result in minor or moderate injury. It may also be used to alert against unsafe practices.

SAFETY WARNINGS

DANGER

DO NOT use a fuel gas that is not listed on the nameplate as compatible with the water heater. Abnormal combustion or a deflagration may occur which can cause a serious accident

DO NOT use the unit if the vent piping has been damaged or altered in any way including cracking, separation, rusting, melting, etc. Improper venting may cause a buildup of Carbon Monoxide (CO) which can cause brain damage or death.

WARNING

- If the water heater needs to be installed, moved, or serviced only utilize licensed professionals. The use of professionals ensures all work is in full compliance with required building, plumbing and electrical codes.
- Keep the area around the appliance clear and free of flammable materials such as cloth, wood, aerosol cans, paper, gasoline, etc.
- When using hot water for a shower or bath always check the water temperature before entry to avoid being scalded. Obey local codes for the maximum water temperature setting allowed. Water temperatures over 125°F (52°C) can cause severe burns or death from scalds. Households with small children, disabled or elderly persons may require a setting of 120°F (49°C) or lower.
- This heater is designed only for the heating of water and should not be used for other applications or used to heat any other media
- Never use a fuel gas that is not listed on the nameplate as compatible with the water heater. Abnormal combustion or a deflagration may occur which can cause a serious accident including damage to the heater.
- Do not use this appliance if any part has been under water. Consult a qualified service technician to inspect the appliance and make any required repairs prior to installation and operation.
- This water heater is designed for indoor mounting. Never mount it outdoors.
- This equipment should be installed in an area where water leakage from the unit or connections will not result in damage. The manufacturer is not responsible for any damages resulting from leaks.
- Only connect gas and water as instructed. Incorrect or reversed connections will cause equipment damage.
- Do not over tighten connections or equipment may be damaged.
- Do not install in areas that are subject to vibration.

SAFETY WARNINGS (continued)

- This equipment shall not be operated without the vent pipe properly connected. The exhaust pipe must not terminate in an area where the exhausting vapor or collecting condensate could create a hazardous situation or cause property damage. Exhaust gases must be vented out of the building in compliance with all building codes.
- The exhaust piping is very hot during and for a period after use. Do not touch the pipe.
- Ensure that snow, ice or other debris does not block the inlet or exhaust pipes.
- Regular housekeeping should be done in areas around the heaters to prevent insect intrusion and possible equipment malfunction.
- The unit should be serviced on a routine basis to ensure optimum performance. Service needs will vary based on local water conditions including acidity, alkalinity, hardness, etc.
- Freezing temperatures will cause damage to the heater. Install in locations where freezing temperatures are not reached and follow procedures to drain the unit if it will be out of service for a period of time. Damage to the unit due to freeze is not covered under the manufacturer warranty.
- A 120 V / 60 Hz power source should be used. Fire, electrical shock or damage to the water heater may occur if an incorrect power supply is used.
- This appliance is equipped with a three-prong grounded plug for increased protection against electrical shock. Ensure the plug is properly inserted into a clean, dry outlet that complies with all electrical codes. Only insert and remove the plug using the plug head and never use a wet hand to plug or unplug the power plug.
- Any alterations to the appliance will void the warranty.
- Should overheating occur or the gas supply fails to shut off, turn off the manual gas control valve to the appliance.
- Do not use this appliance if any part has been under water. Immediately call a qualified service technician to inspect the appliance and to replace any part of the control system and any gas control which has been under water.
- Caution: Label all wires prior to disconnection when servicing controls. Wiring errors can cause improper and dangerous operation.
- Verify proper operation after servicing.

OPERATION

DESCRIPTION OF OPERATION

- Marey gas tankless water heaters provide an efficient reliable supply of hot water.
- The temperature can be adjusted between 35°C - 60°C (95°F et 140°F).
- Only a small amount of water and a low water pressure (15psi) are required for the unit. Unit requires 0.67 gpm (2.5 l/min) to enable the unit. Unit stays in operation until the flow drops below 0.53 gpm (2 l/min).
- The burner ignition is electronic. The unit has no pilot light and consumes no gas when the heater is not being used.
- Air is brought into the unit from outside, efficiently burned with the appropriate source of fuel and then exhausted externally.
- The unit's integrated control system constantly monitors the temperature of the water being produced and adjusts the burner accordingly to deliver a stable supply of hot water.
- The unit is highly flexible and provides hot water over a wide range of flow rates and incoming water temperatures across the capacity range of the unit.
- This model Marey gas tankless water heater includes convenient **H2O Saver Technology™**, a digital functionality that allows owners to control hot water consumption and conserve water.
- Multiple protective functions are included such as no-load heating prevention, automatic shutdown in case of accidental flameout, automatic pressure relief, etc. to make the appliance both safe and reliable

OPERATING INSTRUCTIONS

Normal Operation

This section of the manual instructs an owner on routine operating procedures and assumes that the water heater has already been installed, tested, and approved for operation. Initial start up requirements are detailed in the “**Installation**” section of this manual.

Routine Start Up

Follow this procedure for a heater that has been out of service.

1. Ensure all drain plugs are installed in unit.
2. Ensure all hot water use points (faucets, etc) are closed.
3. Open the water inlet valve.

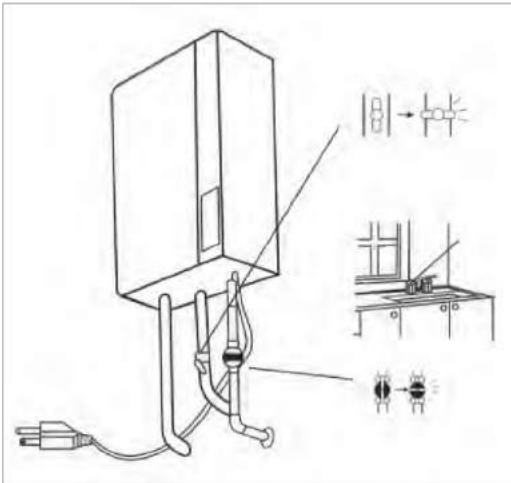

4. Open a hot water faucet to confirm water flow and then close the faucet.
5. Open the fuel gas valve.
6. Plug in the unit.
7. Press the “ON/OFF” key to turn on the unit. The message “CL” will be displayed indicating “Cold” state.
8. Set temperature (see “Temperature Control” section of this manual)

Control Panel

The Control Panel and display are used to adjust the operational settings of the unit as well as give information about the current state of operation. The following illustration shows all possible symbols and signs that may appear in various states of operation. In operation only the symbol or sign corresponding to the actual state will appear on the control panel display. The water heater is in an operating state when the hot water temperature is shown.

Figure 2 - Control Panel Diagram

When the water temperature is above 95 ° F (35 ° C) the lights are on, one by one from the bottom to overcome.

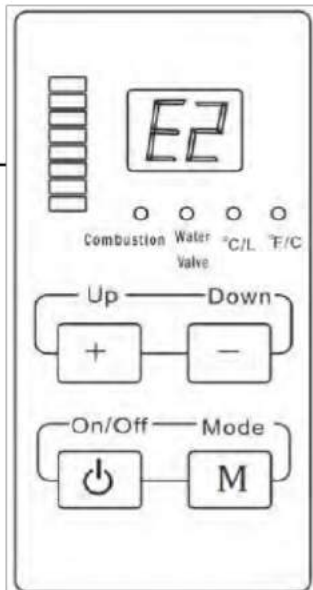

The failure mode displays when a failure occurs, the temperature display mode is changed to the mode of failure display.

Mode function selection

CONTROL PANEL INDICATIONS

LED display

1. Indicates the “Temperature Set Point” when blinking.
Displays the “Actual Temperature” when the display remains lit.
2. Displays both the “Preset Water Quantity” and the “Actual Water Quantity”.

“**Combustion**” - When lit indicates that the water heater is operating and burning gas.

“**Water valve**” - Indicates one of the following three states:

1. No light indicates water heater is operating normally.
2. Blinking: Indicates there is no water flow through the water heater or the water flow is less than 0.66 gallons per minute (2.5 liters per minute)
3. When on and remaining lit, the firepower of the water heater is operating at either the minimum or maximum operating point. The actual water temperature may not reach the preset temperature. The water flow rate needs to be adjusted so the unit is operating within its capacity range. This will allow the desired temperature to be reached.

“**°C/L**” - Indicates metric units are being displayed (degrees Celsius, Liters)

“**°F/G**” - Indicates English units are being displayed (degrees Fahrenheit, Gallons)

“**Up + / Down -**” keys - Used for setting the water temperature and water quantity.

“**Mode**” key - Used to Set (F4) the water quantity or Display (F3) the water volume already delivered.

“**OFF/ON**” key: This button enables or disables the water heater. In the “ON” mode, the temperature set point is displayed. The factory default temperature setting is 107°F (42°C). In the “OFF” mode, “CL” (Cold) is displayed.

TEMPERATURE CONTROL

Set the Desired Temperature

1. The temperature adjustment range is 35°C – 60°C (95°F – 140°F).
2. Press the “OFF/ON” key. The temperature display unit lights up and displays the current temperature set point. The factory default set point is 42°C (107°F).
3. Press the “UP” or “DOWN” key to set any desired temperature between 35°C (95°F) and 50°C (122°F). The temperature set point goes up or down by one degree with each press.
4. To set a temperature above 50°C (122°F): Press and hold the “UP” key continuously for about 4 seconds until “55°C” (131°F) is displayed.
5. Note: When the temperature is above 50°C (122°F), each press of the “UP (DOWN)” key causes the temperature to go up (down) by 5°C (9°F).
6. When the desired temperature is set above 50°C (122°F), the temperature display blinks for approximately 4 seconds before the display switches to show actual water temperature.
7. Along the left side of the temperature display, a series of bars indicates the level of the temperature set point. At each 5°C (9°F) increment, an additional bar lights. When the set point is above 50°C (122°F), the first red bar appears indicating the set point is in a zone where a scalding hazard exists.
8. The heater will retain the temperature set point unless there is a loss of power.
9. After the temperature is set, open the water valve and observe. The “Combustion” indicator should light to signal the unit is operating normally.



SCALD PREVENTION

- Water temperatures over 125°F will scald and can instantly cause severe burns or death!
- Children, disabled and elderly are at highest risk of being scalded
- Always test the water temperature by feeling the water prior to entering a shower, bath, etc.
- Obey all codes regarding temperature set point.
- Contact a licensed plumber or local plumbing authority for clarification or additional information.





IMPORTANT! The volume measurement only keeps track of the water volume that passes through the water heater.

For example, if hot water going to a tub is combined with cold water, the volume computed would not be representative of the total amount that may have filled the tub. This could lead to an overflow or damage!

Monitoring the Volume Delivered

Press the "MODE" key. The message "F3" will be displayed. Press the "UP" (or DOWN) key briefly. The mode will switch from temperature display mode to water quantity display mode.

The water volume already delivered is displayed. Example: "5" = 5×10 (50L or 50G).

Power Outage

In the event of a power outage or if the unit is unplugged, settings are restored to their factory default values.

WIRED REMOTE CONTROL PANEL

The heater may be controlled by a wired remote control (**OPTIONAL**). The controller can be located near a bath, shower or other location.

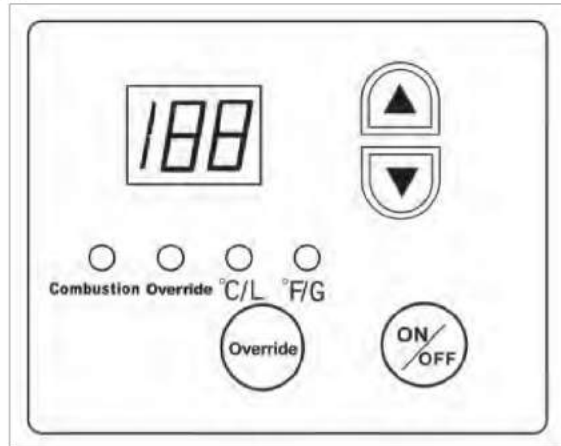

Figure 3 - Wired Remote Control Panel

Remote Control Panel Functions (continued)

Remote Control Panel Indications

“Combustion” - When lit indicates that the water heater is operating and burning gas.

“Override” – When indicator light is on, this wired control panel can change the temperature set point.

“°C/L” - Indicates metric units are being displayed (degrees Celsius, liters)

“°F/G” - Indicates English units are being displayed (degrees Fahrenheit, gallons)

Remote Control Panel Functions

- Remote shut down: If the water heater needs to be stopped when it is operating, press the “OFF/ON” key. The displayed hot water temperature disappears. The water heater has stopped operating. The “Combustion” indicating light will go out. The water flow is not controlled by the remote. The water flow will continue until the faucet or shower is turned off. An alert on the controller will sound nonstop as a reminder that there is flow through the heater while the heater is turned off.
- Switch between metric and English units: Press and hold the “Temperature up” and “Temperature down” keys at the same time for three seconds.
- Override (Priority) Control: Up to three remote control panels may be connected to the system. At any given time, one of the control panels can become the “priority” controller. The priority controller becomes the master temperature control device for the system.

To set priority:

1. Turn off the override if it is set on another controller. Press and hold the “Override” key to release priority. The Override indicator light will go out.
 2. Select the new controller to take control. Press and hold the “Override” key on the wired operation panel which should have priority. The “Override” indicator will turn on and the temperature set point may be adjusted from this controller per below.
- Change the Temperature Set Point: First, enable “override” or priority control for this remote control. Next, press the “ON/OFF” key two times on the operation panel. The “Override” indicator will stay lit. Adjust the temperature using the “Up” and “Down” arrows.
 - The temperature may be adjusted in one degree increments between 35°C (95°F) and 50°C (122°F).

EXTENDED SHUTDOWN

Extended Outage Procedure

If a heater will be out of service for an extended amount of time, use the following procedure to protect the unit.

NOTES

- Cold air may enter the unit through the air intake or the exhaust system. Take precaution for extended shutdowns even if unit is installed indoors in an area that does not allow direct exposure to freezing temperatures.
- Temperatures at or below 0°C (32°F) can cause permanent damage the unit and/or the piping system due to freezing. Damages to the unit because of freezing are not covered under the manufacturer warranty.
- After a power outage, all settings return to their factory default values.



The heater and water within the unit may be very hot. Allow time for the system to cool and use caution when draining to minimize risk of injury.

1. Shut down the water heater by pressing the “ON/OFF” button. “CL” will appear indicating “Cold” state. (“Cold”).

2. Close the fuel gas valve (1).

3. Unplug the power cord (3). Use dry hands. Exercise caution and only unplug by grasping the plug head and pulling. Note, all factory settings will be restored next time unit is re-powered.

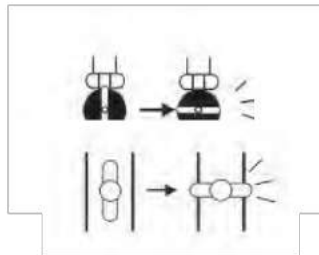

4. Close the water inlet valve. (4)

5. Open all hot water faucets.

6. Obtain an appropriate container to collect the residual water from the system.

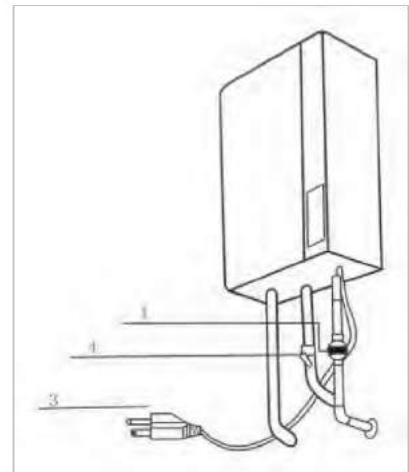

WARNING

Prevent water from being discharged on the floor to avoid damage.
Prevent water contact with any electrical source in the vicinity.

7. Open the drain plugs and completely drain the water heater.

8. Continue draining to empty the whole hot water system.

Note: Freezing temperatures below 0°C (32°F) can cause permanent damage to the heater and/or the piping system.

9. Reinstall the drain plugs and close the hot water faucets.

10. To return a unit to operation, please refer to “Routine Start Up” found in the Operating Instructions section of this manual.

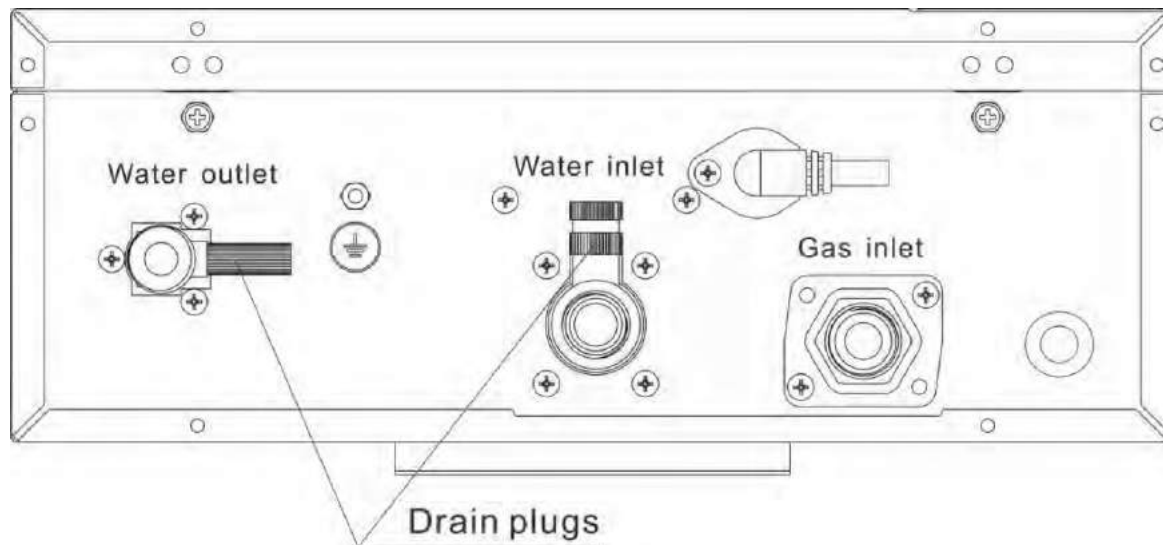

Figure 4 - Drain plug location

COLD WEATHER WARNINGS

Freezing Damage Potential and Precautions

Freezing temperatures can damage the water heater and/or water piping. Freezing water expands rapidly and can create tremendous mechanical forces. Mechanical damage and pipe ruptures can result from only brief exposure to freezing temperatures.

FREEZE damage is not covered under the manufacturer's warranty.

For best results, completely shut down the system by following the Extended Outage Procedure section of this manual.

In cold regions, insulating material or heat tracing can be used to protect pipes and fittings. Please consult your dealer if necessary.

Cold Weather with Potential Freezing Temperatures

Keep water flowing through the system to guard against freezing.

Follow these steps:

1. Close the fuel gas valve.
2. Turn off the power by pressing the "ON/OFF" button. "CL" will be displayed when off.
3. Open the hot water faucet at a one or more points of use (sink, upstairs bathtub, etc.)
Maintain a constant trickle. Monitor the stream of water to ensure it is still flowing.

No Flow Due to Expected Frozen Heater

1. Close both the fuel gas valve and the water inlet valve.
2. Turn off the power switch.
3. Open a hot water faucet.
4. Open the water inlet valve now and then to check for a water flow.
5. If no flow, attempt to thaw heater by using a portable heat source such as a hair dryer or portable electric heater.
6. Check occasionally to see if water flow has started.
7. When water flow resumes, carefully check for any signs of water leakage.
8. Resume normal operation



To prevent damage, NEVER force a heater to operate while in a frozen state. NEVER bypass any safety feature.

Warranty

Damage caused by freezing is NOT covered by manufacturer's warranty.

MAINTENANCE AND INSPECTION

Routine Inspection



The heater and exhaust piping will be hot during and shortly after use. Use caution when working in the area around the heater.

To keep your water heater operating optimally please refer to the below recommended inspection and maintenance checklists. Marey recommends a periodic inspection performed by a qualified service technician. An annual inspection is normally sufficient. Frequent visual inspections by the owner are recommended. Any repairs should be performed by a qualified service technician using only factory authorized components.

Routine Inspection Checklist

- Any flammable materials in the vicinity of the water heater or exhaust piping?
- Any unusual noises coming from the heater while in operation?
- Are the air intake and exhaust free from any blockage or foreign objects?
- Are there any signs of water leakage around the water heater or pipes?
- Any signs of water leaking near heater or pipes?
- Any abnormal appearance to unit casing?

Maintenance Checklist

- Clean outside of unit and control panel
 - o Use a wet cloth to remove any surface dirt. Use a dry cloth to wipe it dry.
 - o A very mild detergent may be used if unit is very dirty.
 - o Never use any petroleum based cleaners or solvents. These solvents can damage the panel.
- Check and clear Air Intake of any debris that might impede air flow.
- Clean inlet water screen
- Examine venting system
- Clean inside of unit by vacuuming or blowing out dust that collects in the unit. Do not open the burner this cleaning should only be done by authorized service personnel.
- Visual flame inspection
- Lime scale cleaning (if required)

MAINTENANCE PROCEDURES

BURNER INSPECTION AND CLEANING

1. The burner must flame evenly over the entire surface of the burner head when operating correctly.
2. The flame should burn with a clear, blue, stable flame.
3. Presence of a yellow flame or of black deposits on the burner head indicates cleaning and/or burner replacement should occur.

MAINTENANCE BLOWER

1. The fan motor is permanently lubricated and does not require periodic lubrication.
2. If the engine fails, it must be replaced by a qualified technician only.

PURGE THE PRESSURE RELIEF VALVE

If a pressure relief valve discharges periodically, this may be due to thermal expansion occurring in a water supply system in a closed circuit. Contact the water supplier or local plumbing inspector for the best way to solve this problem. Do not block the pressure relief valve.

LIME SCALE CLEANING PROCEDURE

Materials required:

- *Five-gallon container
- *Four gallons of virgin food grade white vinegar or virgin food grade citric acid
- *Small inline recirculation pump capable of circulating 2 - 4 gpm (8 – 16 l/m)
- *Set of hoses for connecting recirculation pump to and from the pump and the five-gallon container.

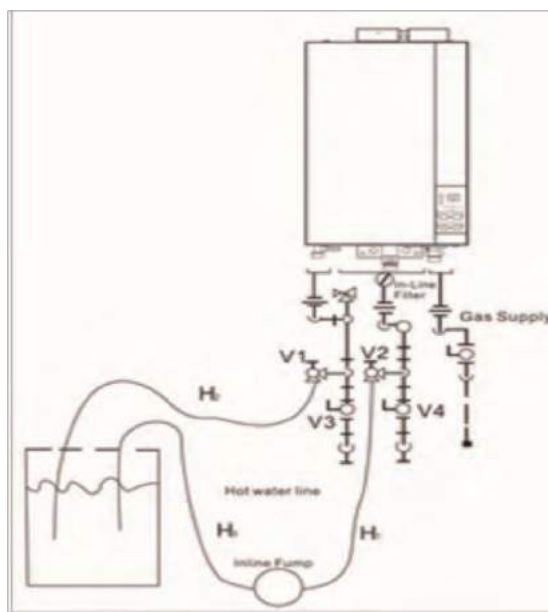

LIME SCALE CLEANING PROCEDURE (continued)

1. Disconnect electrical power to the water heater.
2. Close the shutoff valves V3 and V4 on both the hot and cold water lines
3. Connect a hose H1 from the pump outlet to the cold water line V2 into the heater.
4. Connect drain hose H2 from the hot water outlet line V1 and route into five-gallon recirculation container.
5. Pour approx. four (4) gallons of virgin, food grade, white vinegar or citric acid into pail.
6. Place the pump suction hose H2 into the cleaning solution.
7. Open valves V1 and V2 into the water heater.
8. Operate the pump. Circulate the cleaning solution through the water heater for at least 45 minutes.
9. Turn off the pump.
10. Rinse the cleaning solution from the water heater by closing valve V2 and opening valve V4, flow water through the heater and into a container or drain for at least five minutes.
11. Close Valve V1 and Open Valve V3 this places the house back online.
12. Disconnect all hoses.
13. It is also wise to clean the water inlet screen at this time. Close Valve V3 and V4 to do so.
Clean the water inlet screen and remove any debris.
14. Replace the screen and open valves V3 and V4 once more. Checks for leaks.
15. Return heater to operation by following start up instructions.

ELECTRICAL MAINTENANCE WARNINGS



Label all wires prior to disconnection when serving controls. Wiring errors can cause improper and dangerous operation. Always verify proper operation after servicing.

TROUBLESHOOTING

For operating difficulties with your unit, please consult the following table for guidance. If you need further assistance, call Marey Heater Corp. toll free service and support line at 1-855-627-3955. Please have product information ready when you call including serial number, date of purchase and error code if shown on the control panel.

Note: Please check water heater for an-error code and respond according to recommendations found in “Error Codes” portion of this manual.

Issue	Possible Cause	Solution
No power: Power indicator lamp is not lit	Power outage	Unit requires 120V power. Use unit when power is restored. Check circuit breaker and reset if needed. Check ground fault circuit interrupter (GFCI) if circuit includes one and reset if necessary.
	Unit is unplugged	Check power plug and ensure properly plugged. Plug the power plug properly.
There is no hot water flow when a hot water faucet is opened.	No/empty fuel source	Fuel gas valve needs to be open Refill source tank (if applicable)
	Water valve closed	Open the water inlet valve.
	Power outage	Unit requires 120V power to operate.
	Flow is too low or became too low. (less than 0.66 gallons per minute (gpm) or 2.5 liters per minute (l/m)	Flow is below the lower limit necessary for stable burner operation and proper temperature control. Increase the hot water flow to enable system.
	Freezing temperatures may have frozen water in the heater or hot water system.	See “No Flow Due to Expected Frozen Heater” section of this manual for procedure to thaw unit.
	Fuel gas meter special control restrictions	Some fuel gas valves may have special restrictions or digital controls that use. Consult your gas supplier and/or a service professional for assistance.
Distance from heater to source is long	Allow time for hot water to travel through system to reach the point of use.	

Issue	Possible Cause	Solution
Hot water is not the right temperature (too hot or too cold)	<p>Temperature set point was reset due to power outage.</p> <p>Temperature set point incorrect.</p> <p>Flow is beyond capacity</p> <p>Incoming water is too warm</p>	<p>Power outage restores default settings and custom set points must be re-entered to unit</p> <p>A remote wired controller is controlling temperature set point. Release override control of this remote (see "Remote Control Panel Functions") or change set point to desired temperature with that remote.</p> <p>Desired water flow is above maximum capacity of unit. Reduce user flows to re-establish control of temperature</p> <p>If incoming water to unit is very warm and the flow is just above minimum requirements, the heat generated by the burner while operating at minimum capacity can make the water hotter than desired. Increase the hot water user flow so that the burner system can control the temperature.</p>
Hot water flow produced is lower than expected	<p>Water source is restricted</p> <p>Heat exchanger in unit is scaled</p> <p>Incoming water temperature is colder than expected</p>	<p>Check and fully open water inlet valve(s) Check and clean inlet water screen</p> <p>Clean heat exchanger by flushing per maintenance procedure.</p> <p>Colder than normal incoming supply water will reduce the amount of hot water than can be produced. Although the amount of heat output from the unit is still at full capacity, you must reduce the user flow and operate within the capacity range of the heater.</p>

<p>The hot water coming appears white and turbid.</p>	<p>Small bubbles may appear when water is heated. Air dissolved in water may evolve when water is heated.</p>	<p>None. Normal operation.</p>
---	---	--------------------------------

Issue	Possible Cause	Solution
Vent system trouble	Vent system is restricted in some manner.	Check air intake and exhaust ducts to ensure they are not damaged, corroded, blocked, etc.
“Smoke” observed coming from exhaust system during cold temperatures	Water vapor produced during combustion is condensed in the exhaust as the hot gas is cooled by the outside air.	None. Normal operation.
Water leaking from safety valve outlet	Water system is operating above design pressure. Safety valve is damaged.	Consult professional for system review. Replace safety valve. Consult professional as required.
Blower fan noise can be heard for some time after operation stops.	The blower is designed to run for 30 seconds after burner shuts off.	None. Normal operation
The volume alarm does not sound even though the volume appears to be adequate	Units incorrect during input Measuring flow of only hot water instead of hot water and cold water combined	Refer to “H2O SAVER TECHNOLOGY™ - Set a Desired Volume” section to ensure units (metric vs. English) and volume (displayed volume number represents 1/10th of the actual total flow) are correctly set. The volume measurement only keeps track of the water volume that passes through the water heater. If hot water going to a tub is combined with cold water, the volume computed would not be representative of the total, amount that may have been dispensed.
Unresolved problem	Other assistance required	Consult Chinabest Home Appliance Co., Ltd or contact an authorized service professional.

DIAGNOSTIC CODES

Whenever a failure occurs, an alert sounds and a diagnostic code is displayed to indicate the failure mode at the time of occurrence.

The following table includes a list of diagnostic codes that can be displayed as well as recommended remedies to address the problem.

Figure 5 - Control Panel
Example- Displaying Error
Code E2

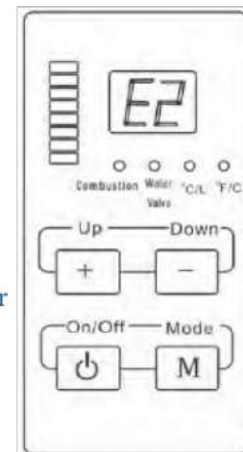

Code	Indication	Solution
E0	<p>Blower system problem occurred.</p> <ol style="list-style-type: none"> 1. The blower jammed or stopped operating because of a foreign object. 2. The blower fan suffered a mechanical breakdown. 3. The fan power control module has broken down. 4. Wiring harness or wiring connection somewhere in fan connection has come loose. 	<ol style="list-style-type: none"> 1. Check to see if fan turns freely. Remove any foreign objects jamming the fan. 2. Replace the blower fan. 3. Replace the control module. 4. Reconnect as required.

E1	<p>Outlet water temperature sensor error.</p> <ol style="list-style-type: none"> 1. The sensor plug has come loose or failed to connect properly to the circuit board. 2. The sensor broke down (A short circuit, open circuit, or accidental contact with the casing occurred.) 3. The circuit board of the main controller malfunctioned. 4. Sensor is scaled 	<ol style="list-style-type: none"> 1. Plug in the element properly. 2. Replace the temperature sensor. 3. Replace the controller 4. Clean sensor
----	--	--

Code	Indication	Solution
E2	<p>Flame detection error.</p> <ol style="list-style-type: none"> 1. The detection circuitry for ignition and flame detection has come loose or failed to connect. 2. Ignition sequence was unsuccessful. 3. An accidental flameout occurred. 4. The ignition and flame detection circuitry malfunctioned or broke down. Igniter is not activating. 5. Flame sensor is dirty/fouled (can be indicated by a weakly lit combustion indicator light.) 	<ol style="list-style-type: none"> 1. Connect the relevant circuit properly and eliminate the bad connection. Replace any failed circuit elements. 2. Check fuel gas supply. Check if the fuel gas pressure is too high or too low. 3. Check if the fuel gas pressure and water pressure are normal. Possible air in the fuel gas pipe on start up. Water pressure is too low causing flow to drop below required minimum flow 4. Replace or repair igniter or flame detection system. 5. Inspect flame sensor and clean or replace if required.

E3	<p>Inlet water temperature sensor problem.</p> <p>Same possible causes described in Section E1.</p>	<p>Same troubleshooting methods described in E1.</p>
E4	<p>High temperature automatic shutdown.</p> <p>For ten (10) seconds a water temperature above 85°C 85°C The controller has automatically closed the electromagnetic valve and unit shut down.</p>	<p>Normal safety precaution to protect against a rare occurrence in which unit is enabled and then the water flow is dramatically reduced causing a small slug of very hot water.</p>

E5	<p>Overheating occurred</p> <ol style="list-style-type: none"> 1. Overheating occurred. Possible causes include operating at a very high load for a long period and then there is a sudden event such as excessively low pressure in water supply or excessively high gas supply pressure. 2. The temperature controller or the high temperature fusible protection wire has separated. 	<ol style="list-style-type: none"> 1. Normal system function. This should be a very infrequent event. Correct gas or water supply issues if there are frequent reoccurrence. 2. Replace the fusible protection wire.
E6	<p>Solenoid valve error.</p> <ol style="list-style-type: none"> 1. The wiring is loose or a bad connection occurred. 2. The solenoid valve is faulty. 3. Controller has failed. 	<ol style="list-style-type: none"> 1. Mount plug-in wiring properly and replace bad elements. 2. Replace solenoid valve. 3. Repair or replace the controller.
E8	<p>Blower fan system error.</p> <ol style="list-style-type: none"> 1. The blower jammed or stopped operating because of a foreign object. 2. The blower fan suffered a mechanical breakdown. 3. The fan power control module has broken down. 4. Wiring harness or wiring connection somewhere in fan connection has come loose. 5. The pressure vent is jammed. 6. The pressure switch is damaged. 	<p>Same error as E0?</p> <ol style="list-style-type: none"> 1. Remove foreign things and eliminate the cause that led to a jammed fan. 2. Replace the blower fan 3. Replace control board. 4. Plug the plug-in element in place, or replace the bad element. 5. Replace and/or clean the vent. 6. Replace the pressure switch.

INSTALLATION

INSTALLATION GUIDELINES

Only properly qualified personnel should install this equipment. Improper installation or installation by a non-qualified installer may void warranty. Failure to comply with state and local codes pertaining to water heater installations may void also warranty.

Marey Heater Corp. water heaters are suitable for installation as a single stand-alone unit or in installations involving combinations of multiple units (i.e. parallel or series). These guidelines are for the installation of a single unit. Please contact Marey Heater Corp. for multiple device connection assistance.

This appliance shall NOT be installed outdoors.

The appliance and its gas connection must be leak tested before placing the appliance in operation. A qualified installer or service technician should inspect and leak test system before use. The installation must comply with local codes. In the absence of local codes, the National Fuel Gas Code, ANSI Z223.1/NFPA 54, or the Natural Gas and Propane Installation Code, CSA B149.1 shall prevail. If installed in a manufactured home, the installation must confirm with the Manufactured Home Construction and Safety Standard, Title 24 CFR, Part 3280 or the Canadian standard CSA Z240 MH Series, Manufactured Homes.

The appliance must be electrically grounded in accordance with local codes. In the event there are no local codes, the National Electrical Code, ANSI/NFPA 70, or the Canadian Electrical Code, CSA C22.1 shall prevail.

Maximum inlet gas pressure must not exceed 13.0" wc (3.23 kPa) and that the minimum inlet gas pressure at least 8.0" wc (1.99 kPa)

The appliance and its individual shut off valve must be disconnected from the gas supply piping system during any pressure testing of that system at test pressures in excess of ½ psi (3.5 kPa).

The appliance must be isolated from the gas supply piping system by closing its individual manual shut off valve during any pressure testing of the gas supply piping system at test pressures equal to or less than ½ psi (3.5 kPa).

The gas pressure will be between these values 3.5 in W.C. (870 Pa) 10.5 in W.C. (2610 Pa) for natural gas and 8.0 in W.C. (1990 Pa) 13.0 in W.C. (3230 Pa) for liquid propane.

The appliance should be located in an area where leakage of the tank or connections will not result in damage to the area adjacent to the appliance or to lower floors of the structure. When such locations cannot be avoided, it is recommended that a suitable drain pan, adequately drained, be installed under the appliance. The pan must not restrict combustion air flow.

Do not obstruct the combustion air intake or heater exhaust and ensure air intake is not near an area that will allow chemical fumes to enter the combustion air system.

Do not use to heat pools or spas (hot tubs) that uses chemically treated water.





If a water heater is installed in a closed water supply system, such as one having a backflow preventer in the cold water supply line, means shall be provided to control thermal expansion.

Contact the water supplier or local plumbing inspector on how to control this situation.

PACKING LIST

(NEED PACKING LIST AND DRAWINGS OF COMPONENTS) The following contents are included. If any items are missing contact Chinabest Home Appliance Co.,Ltd's toll free support line: 1-800-295-8039.

ITEM	ITEM#	QUANTITY
WATER HEATER	A	1
INSTALLATION AND USE GUIDE	B	1
JOINT	C	8
TAPPING SCREW	D	8
EXPANSION DOWEL	E	8
PRESSURE RELIEF VALVE (Included only for units sold to Canada)	F	1

 <p>A: WATER HEATER</p>	<p>B: INSTALLATION AND USE GUIDE</p>
	 <p>C: JOINT</p>
 <p>D: TAPPING SCREW</p>	 <p>F: EXPANSION DOWEL</p>
 <p>G: PRESSURE RELIEF VALVE</p>	

LOCATION AND CLEARANCE REQUIREMENTS

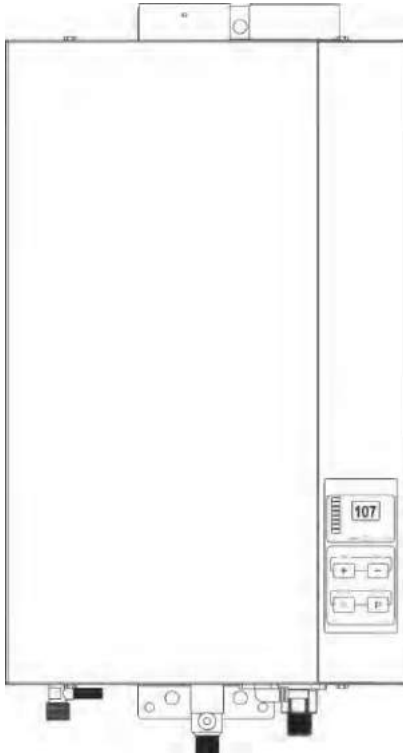

CLEARANCE REQUIRED

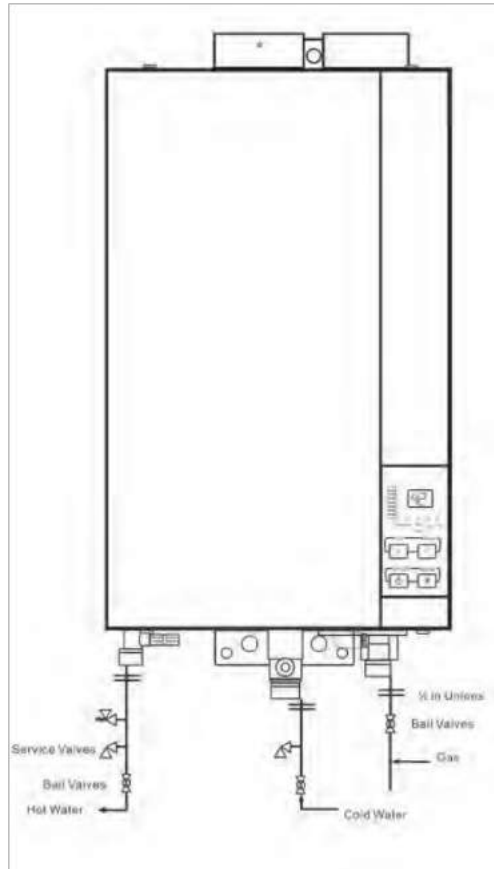

TYPICAL INSTALLATION

CLEARANCE REQUIREMENTS LOCATION

Choose a location for unit installation taking into account the following guidelines.

- Unit must be installed indoors. Installation is not recommended in bathrooms, bedrooms or occupied rooms that are normally kept closed.
- Unit should have proper clearance as indicated below including ample clearance in front of unit for proper service access.
- Installation is recommended to be at a height that will allow easy viewing and operation of the control panel.
- Heater requires a standard three prong, 120 V /60 Hz grounded AC power outlet within 6 feet of installation location.
- Heater requires a ½" gas supply line(12mm).
- Ventilation requirements must be considered when choosing installation location. Minimizing vent piping will reduce installation costs and maximize efficiency.

	ADJACENT MATERIAL COMPOSITION			
	NON-COMBUSTIBLE		COMBUSTIBLE	
SIDE	2 inches	50 mm	6 inches	150 mm
TOP	2 inches	50 mm	12 inches	300 mm
FLOOR	12 inches	300 mm	12 inches	300 mm
FRONT	24 inches	600 mm	24 inches	600 mm
FRONT	zero	zero	1 inch (25 mm) fireproof insulating panel required	

MOUNTING

WARNING

The heater **MUST** be installed in a vertical position with fuel gas inlet at the bottom and exhaust vent positioned at the top. Installation in any other orientation will result in damage and will void warranty.

1. Identify a suitable location per the “Location and Clearance Guidelines”. Ensure that the heater will be attached in a manner that is sufficient to support the weight of the heater in operation.
2. If the wall is not fireproof, the water heater should then be cushioned with a fireproof board, of which each rim projects beyond the corresponding rim of the water heater by 100mm and is 10mm off the wall.
3. For installation on Concrete or Block: Drill three each 5/16” (or 8 mm) holes at the marked locations. Insert the supplied ¼” (6 mm) Steel expansion bolts into the holes.
4. For wall installation: Locate a stud and use supplied mounting screws or hollow Wall Anchors. To use the hollow wall anchors drill 5/16” holes at marked locations and insert the anchors into the hole. A combination of mounting screws and anchors is acceptable.
5. Remove the cover of water heater from carton.
6. Position the water heater into place. Fasten to the wall.
 - a. Installation height: It is appropriate to use the water heater display or the fire hole to be level with the horizontal visual height (generally 1.5m).
 - b. After determining the height, mark the hole according to the water heater's hanging hole, drill a hole with diameter of Ø8mm and a depth of 50 mm and inserted into the M6 metal expansion bolt. The lower part drill a hole with diameter of Ø6mm and a depth of 35mm and inserted into two Ø6mm plastic expansion. Plug (Figure 1).
 - c. Hang up the water heater and tighten the expansion screw and nut after visually perpendicular to the ground.
 - d. 4.618mm and 127mm are the distance of the hole.

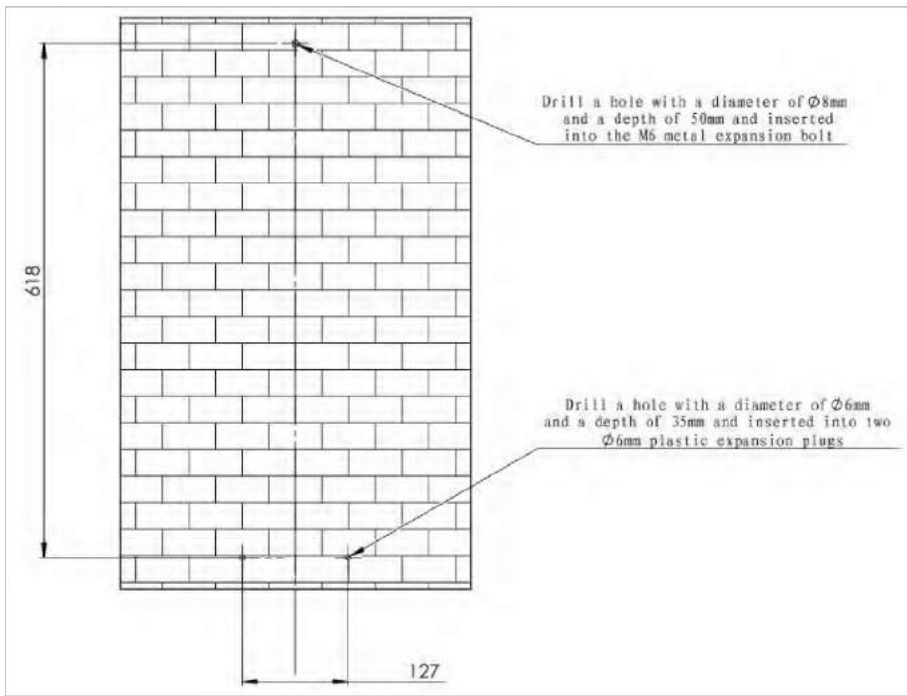

(figure 1)

ELECTRICAL



WARNING

Ensure compliance with applicable electrical codes during installation including the U.S. National Electric Code (NFPA 70) or the Canadian Electrical Code – Part 1 (CGAS C22.1) depending on location.

1. Ensure that a properly grounded 120 V/ 60 Hz three prong outlet is available.
2. DO NOT PLUG IN THE UNIT UNTIL INSTALLATION IS COMPLETE, TESTED, AND READY FOR INITIAL START UP.



Gas piping should be sized, installed, and tested only by a licensed professional! Improper installation can result in improper equipment performance or a hazardous situation.

1. Check the fuel gas type before installation. DO NOT connect a unit if the gas type is not compatible. Contact your dealer for the proper unit to match the gas type.
2. Check the gas inlet pressure immediately upstream at a location provided by the gas company. Ensure the gas pressure is within the limits shown in the Specifications section.
3. Review the installation location taking into account all gas users on site. Calculate the gas piping that will be required to service the installation. The gas supply line shall be sized and installed to provide a supply of gas sufficient to meet the maximum demand of the heater and all other gas consuming appliances at the location.

Note: Reference the National Fuel Gas Code, NFPA 54, for proper line sizing.

4. Ensure any compound used on the threaded joints of the gas piping is compatible with LPG/Propane.
5. Use only approved materials to connect the unit to the gas line.
6. Install a manual gas valve in the gas supply line to the water heater. For best performance the water heater should be the first user downstream from the gas supply meter. A union can be used on the heater sized of the valve to allow for future servicing or disconnection of the unit.
7. Purge the gas line of any debris before connection to the water heater.
8. Connect to the water heater.
9. Leak check all joints including the heater for gas tightness. Use a leak detection solution, soap and water, or an equivalent nonflammable solution, as applicable.



Ensure any leak check solution is non-corrosive and is completely rinsed from the piping after leak check is complete. Corrosion of the gas piping and subsequent leaks could occur.

Never use flammable solutions or an open flame to test for gas leaks!

WATER PIPING

1. All piping, including soldering material, and components connected to this heater shall be approved for use in potable water systems.
2. If the heater has ever been previously used for heating non-potable water, never install the heater later into a potable water system.
3. The installation of manual shutoff valves, drain valves and unions are recommended. A professional should review each installation and ensure adequate ability to isolate, drain, and disconnect heater for service needs.
4. Connect suitable piping from water supply to the water heater. Note, water heater connections are ½" NPT.
5. This unit requires a pressure relief valve. The relief valve must be installed near the hot water outlet.
6. Purge the water line to remove debris and air. Debris can plug and damage the heater.
7. Install the inlet water filter at the cold water inlet. Ensure the filter is easily removable for inspection and cleaning.
8. Test water connections for leaks. Turn on water and purge water through the water heater and system. Flow for 1-2 minutes. Ensure all air is eliminated.
9. After filling and flushing the system, check the inlet water filter for debris and clean as required.
10. Consider insulation on hot water piping for energy conservation and personal protection. Do not insulate the pressure relief valve!

AIR INTAKE AND EXHAUST (VENT) SYSTEM



Improper venting of a water heater can result in excessive levels of Carbon Monoxide which can result in severe injury or death!



This water heater must be vented in accordance with the “Venting of Equipment” section of ANSI Z223.1 / NFPA 54 National Fuel Gas Code – latest versions, or in Canada, the most recent version of CAN/CGA B149.1 Natural Gas and Propane Installation Code. In additional, all installations must completely comply with all applicable local building codes. Failure to comply can result in equipment failure, fire, personal injury or death!

INTAKE AND VENT PIPE INSTALLATION SPECIFICATIONS

- Category III Direct Vent Water Heater.
- For best results always minimize the length of the vent system. Keep the vent pipe routing as short and straight as possible.
- The water heater vent must not be combined with the vent from any other gas appliance or vent stack.
- The water heater must not be connected to a chimney flue serving a separate appliance, designed to burn solid fuel.
- Do not combine use vent or vent connector from multiple manufacturers.
- The heater requires a direct vent. Exhaust vent must be of AL 29-4C Stainless Steel
- Vent directly to the outside of the building.
- The system must use outside air for combustion. Ensure the incoming air is not contaminated by any potential source of fumes or chemicals.
- Avoid any dips or sags in horizontal pipe runs.
- Ensure vent piping is supported every four (4) feet (horizontal runs) or six (6) feet (vertical runs) or in accordance with local code requirements.
- Do not reduce the diameter of the vent piping.
- Ensure all vent connections are installed, properly connected, and sealed air tight per manufacturer's instructions.
- Any vent pipe seams should be installed so they are oriented on the top of horizontal pipe runs.
- Slope exhaust piping towards the exhaust terminal with a 2% slope (1/4 inch per foot ; 19 mm/ m) to ensure rain or any accumulating condensate near termination are drained.
- A condensate collector is required for this system when there is a vertical vent configuration. A condensate collection point should be installed on the vertical run of piping just prior to the heater to ensure proper condensate drainage. Check with local codes for proper disposition and handling of condensate water, an air gaped drain is usually required and in some cases a condensate neutralization is also required.
- Do not store hazardous or combustible materials near the vent piping

- Ensure the air intake and vent termination points are at least 12”(300mm) above any possible snow accumulation level. The flows must not be impeded by snow or debris.
- Ensure the air intake and vent termination points are at least 24”(600mm) from any obstruction or other objects.

The exhaust pipe must maintain adequate clearances and be insulated with a fireproof material if it passes through walls made of flammable materials. Consult local codes and vent pipe manufacture documentation for proper material selection and installation requirements.

Minimum clearance of listed Type B vent or vent connector from a combustible wall or partition must conform to local code, or in the absence of local code, the National Fuel Gas Code, ANSI Z223.1/NFPA 54, or the Natural Gas and Propane Installation Code, CSA B149.1.



CAUTION If the heater will be installed in a building that has a system that maintains a negative pressure, it is possible for a back-draft to allow outside air to be pulled into the heater while not in operation. This can create a situation where freezing might occur within the heater. Please consult a professional for a properly designed venting solution or contact Marey Heater Corp.

AIR INTAKE PIPE ASSEMBLY (please review – this is template)

1. Drill 2 small holes at the end of the air intake pipe.
2. Slide the pipe over the air intake terminal.
3. Using a level, ensure the pipe is straight up and down.
4. With self tapping screws, attach the pipe to the air intake terminal.
5. Apply a bead of silicone around the pipe and air intake terminal, ensuring an air tight connection.

EXHAUST VENT PIPE ASSEMBLY (please review – this is template)

1. Use manufacturer's universal adapter to connect the vent pipe to the unit.
2. Follow the manufacturer's vent pipe assembly guidelines and sample diagrams below.
3. Please use UL certified stainless steel vent pipe as per the standard UL 1738 and ULC S636-BH

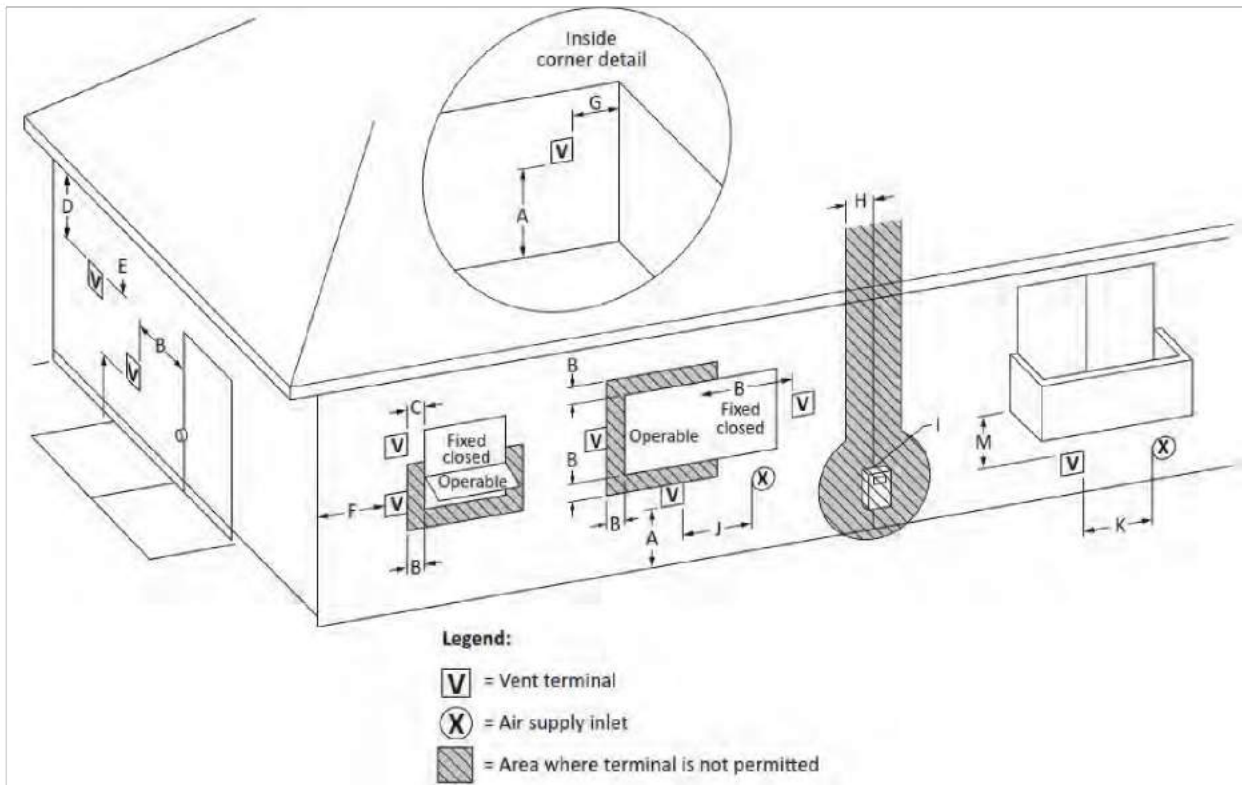

L =	Clearance above paved sidewalk or paved driveway located on public property	*	7 ft (2.13 m) **
M =	Clearance under veranda, porch, deck, or balcony	*	12 in (30 cm) ***
Ref	Clearance Description	US Installations (1)	Canada Installations (2)
A =	Clearance above grade, veranda, porch, deck, or balcony	12 in (30 cm)	12 in (30 cm)
B =	Clearance to window or door that may be opened	12 in (30 cm)	36 in (91 cm)
C =	Clearance to permanently closed window	*	*
D =	Vertical clearance to ventilated soffit located above the terminal within a horizontal distance of 2 ft (61 cm) from the center line of the terminal	*	*
E =	Clearance to unventilated soffit	*	*
F =	Clearance to outside corner	*	*
G =	Clearance to inside corner	*	*
H =	Clearance to each side of the center line extended above meter/regulator assembly	*	*
I =	Clearance to service regulator vent outlet	*	Above a regulator within 3 ft (91 cm) horizontally of the vertical center line of the regulator vent outlet to a maximum vertical distance of 15 ft (4.5 m)
J =	Clearance to non-mechanical air supply inlet to building or the combustion air inlet to any other appliance	12 in (30 cm)	12 in (30 cm)
K =	Clearance to a mechanical air supply inlet	3 ft (91 cm) above if within 10 ft (3 m) horizontally	6 ft (1.83 m)

* For clearances not specified in ANSI Z223.1/NFPA 54 or CSA B149.1, one of the following shall be indicated:

A) a minimum clearance value determined by testing in accordance with Clause 5.21, Draft hoods; or

B) a reference to the following footnote:

"Clearance in accordance with local installation codes and the requirements of the gas supplier."

**A vent shall not terminate directly above a sidewalk or paved driveway that is located between two single family dwellings and serves both dwellings.

*** Permitted only if veranda, porch, deck, or balcony is fully open on a minimum of two sides beneath the floor.

Notes:

(1) In accordance with the current ANSI Z223.1/NFPA 54, National Fuel Gas Code.

(2) In accordance with the current CSA B149.1, Natural Gas and Propane Installation Code.

TERMINATION DETAILS

- Determine the number of elbows of 90 degrees that will be used in the evacuation system (two elbows of 45 degrees being considered as a single elbow of 90 degrees)
 - Refer to the table below to determine the maximum length in function of the number of elbows.
- For example: If you have only one elbow, the maximum length will be 21 ft (6.4m).

Number of elbows of 90°			
0	1	2	3
27ft (8.2m)	21ft (6.4m)	15ft (4.5m)	9ft (2.7m)

RACCORDEMENT DES EXTREMITES

Vertical Terminations

The air intake requires a return bend or two 90° elbows to prevent entry of rain.

The vent termination and air intake must be in the same pressure zone.

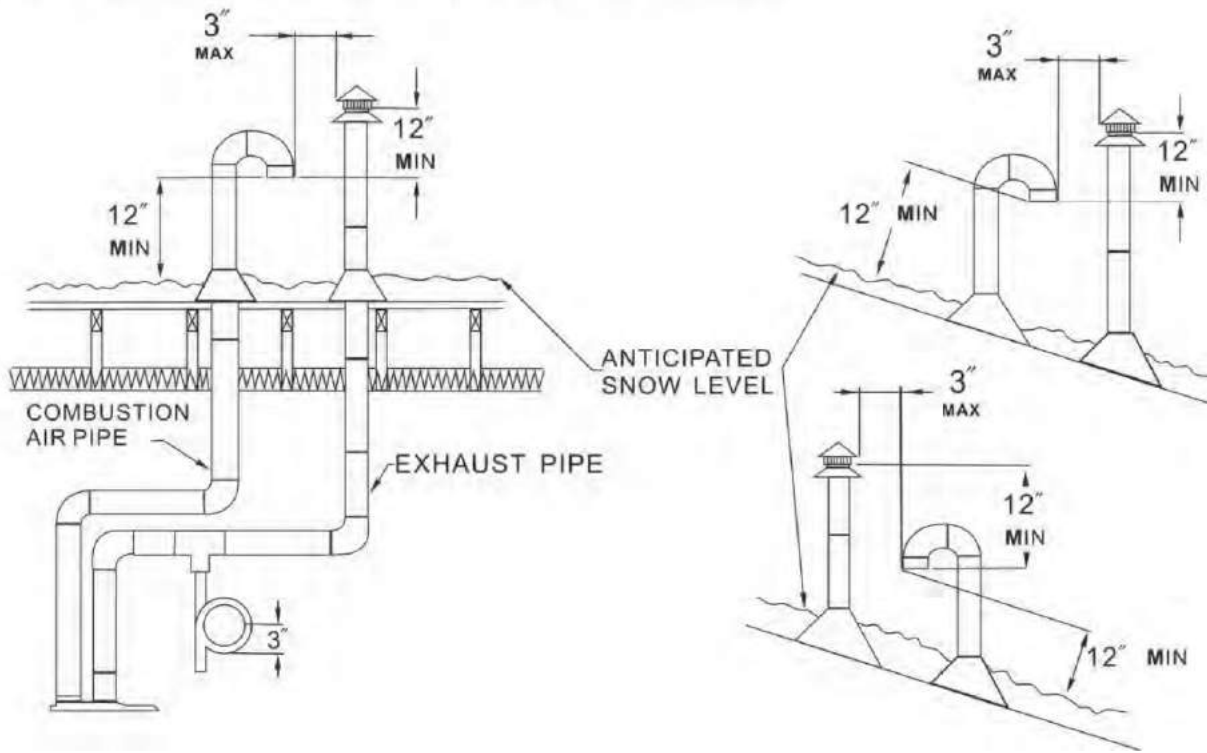

Horizontal Terminations

The air intake must be located in relation to the exhaust as shown below. The air intake must angle 1/4 inch per foot to the termination to prevent entry of rain.

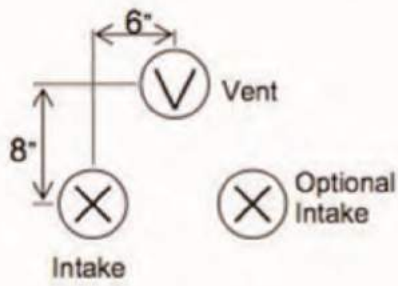

The vent termination and air intake must be in the same pressure zone and face the same direction.

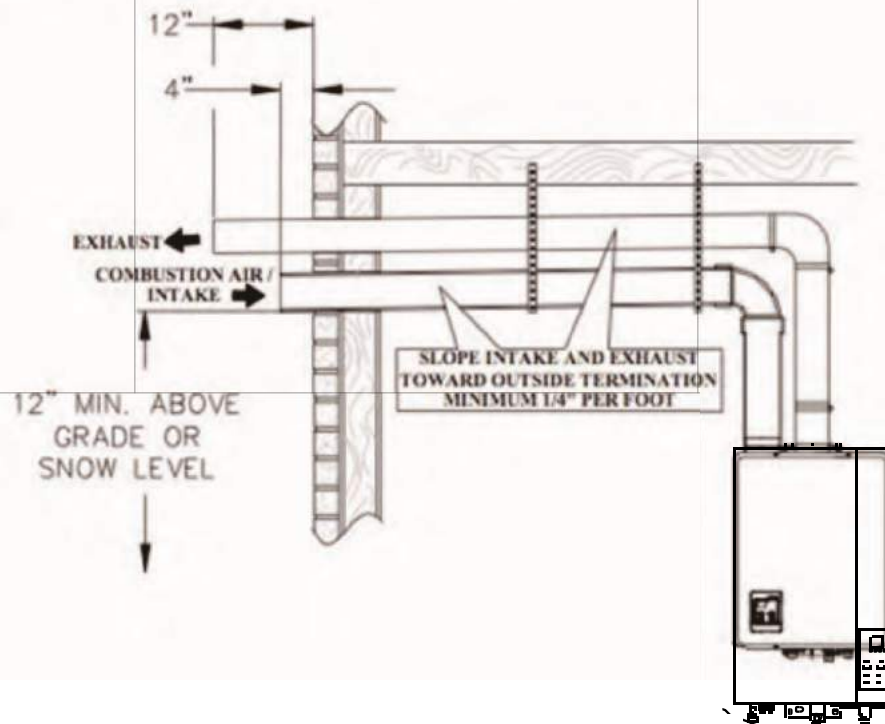

ACCEPTABLE VENT PRODUCTS:

Manufacture	Product	Appliance Adapter	Horizontal Termination	Vertical Termination	Horizontal Concentric Termination	Vertical Concentric Termination
Z-Flex	Z-Vent		2SVSTPX03	2SVSRCF03	2SVS ⁻ C43	NA

Manufacturer Contact Information

Fabricant	Z-Flex
Téléphone	800-654-5600
FAX	888-889-3539
E-Mail	sales@z-flex.com
Site internet	www.novaflex.com

WARNING

WARNING: If the information in these instructions is not followed exactly, a fire or explosion may result causing property damage, personal injury or death.

DANGER

- **Do not store or use gasoline or other flammable vapors and liquids in the vicinity of this or any other appliance.**
- **WHAT TO DO IF YOU SMELL GAS:**
 - **Do not try to light any appliance.**
 - **Do not touch any electrical switch; do not use any phone in your building.**
 - **Immediately call your gas supplier from a neighbor's phone.**
 - **Follow the gas supplier's instructions.**
 - **If you cannot reach your gas supplier, call the fire department.**
- This appliance does not have a pilot. A built-in ignition device will automatically light the burner. Do not try to light the burner by hand.
- Use only your hand to push in or turn the gas control knob. Never use tools. If the knob will not push in or turn by hand, do not try to repair it, call a qualified service technician. Force or attempted repair may result in a fire or explosion.
- Do not use this appliance if any part has been under water. Immediately call a qualified service technician to inspect the appliance and to replace any part of the control system and any gas control that has been under water.

INITIAL START UP

1. STOP! Read the safety information from the previous page.
2. Ensure unit is unplugged and all electric power to the appliance is off.
3. Locate the manual gas valve to the heater. Open the manual gas valve for 15-30 seconds.
4. Turn the manual valve clockwise to the full OFF position.
5. Carefully check for any sign or smell of gas. If gas is detected, wait five (5) minutes for it to clear. STOP and go no further until gas leak point is detected.
6. If no gas is detected, open the manual gas valve for five (5) minutes and again check area for any signs of gas. At any sign of gas, STOP and go no further. Follow the safety precautions from the previous page.
7. If no gas is detected, proceed.
8. Open the water supply valve to the unit. Inspect for any leaks
9. Visually inspect air intake inlet and exhaust piping to ensure they are not obstructed.
10. Plug in the unit. "C/L" is displayed indicated "cold".
11. Press the "ON" button to turn on the unit.
12. Adjust the temperature set point per "Temperature Control" Section of this manual.
13. This appliance is equipped with an ignition device that automatically lights the burner. Do not try to light the burner by hand.
14. Open a hot water tap to a flow above the minimum flow point (0.66 gpm/ 2.5 l/min).
15. The burner control system will fire the igniter, the burner will light, and hot water will be produced.
16. If the heater will not operate, follow the shut down instructions. Wait 5 minutes and attempt to repeat this start up procedure.
17. If system does not operate, begin troubleshooting per "Trouble Shooting" section of this manual. If you require additional information, contact Marey Heater Corp.

Relief valve install

For safe operation of the water heater, be sure that:

- The pressure rating of the relief valve must not exceed 116 psi, the maximum working pressure of the water heater as marked on the rating plate.
- The BTUH rating of the relief valve must equal or exceed the BTUH input of the water heater as marked on its rating plate.
- No valve of any type should be installed between the relief valve and the water heater.
- The discharge line must be NO SMALLER than the outlet of the valve and must pitch downward to allow complete drainage (by gravity) of the relief valve and discharge line.
- The end of the discharge line should not be threaded or concealed. No valve of any type, restriction or reducer coupling should be installed in discharge line

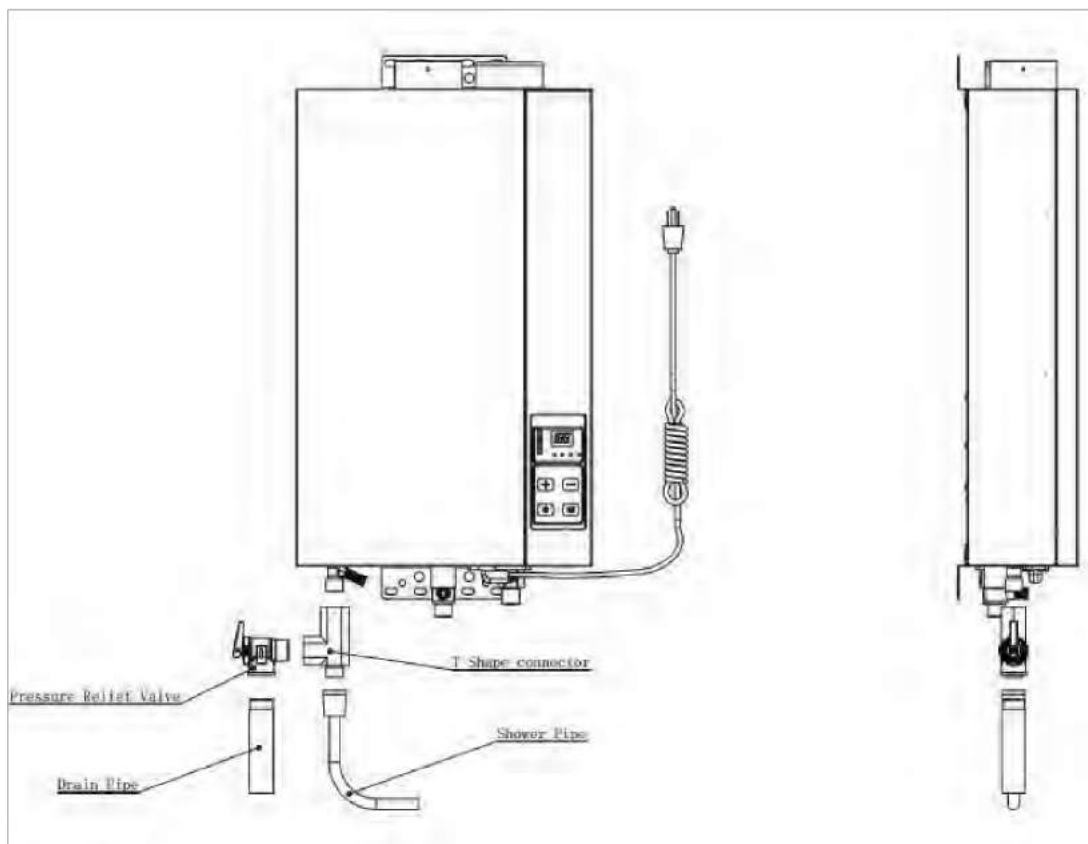

REFERENCE

WIRING DIAGRAMS

Figure X. - wiring diagram GA14CSA; (without wired remote)

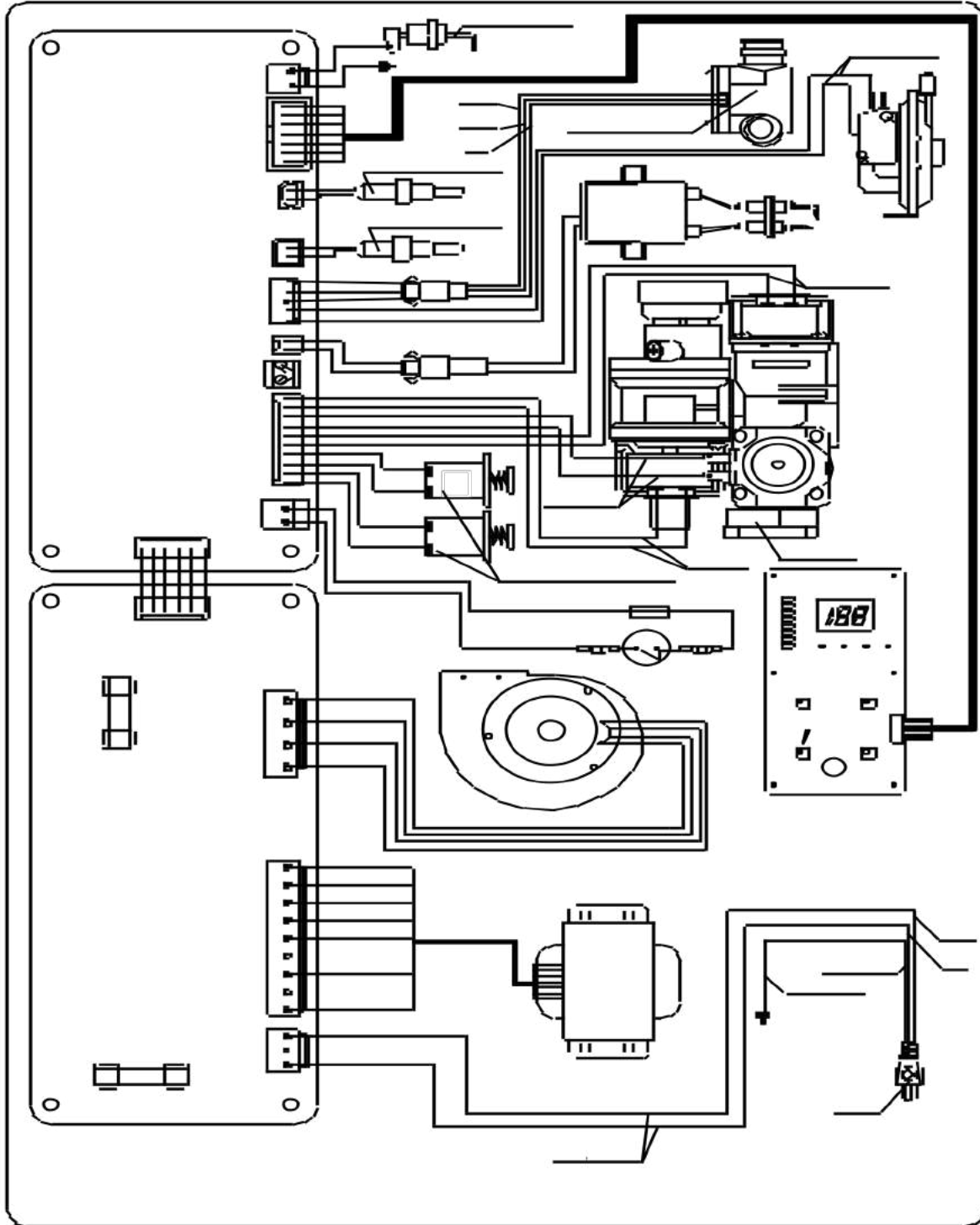

SYSTEM SPECIFICATION

Model No		GA14CSA
Type of Appliance		Temp. controlled continuous Flow Gas Hot Water Unit
Operation		With/without remote controls, mounted in Kitchen, bathroom, etc.
Flue System		Room Sealed-Forced Draught Flue
Available default Temperatures		Actory setting 107°F
Rated gas pressure	Nature gas	7-inch W.C. (1740 Pa)
	Propane (LPG)	11-inch W.C. (2740 Pa)
Temperature Range		Within 35°C ~ 60°C (95°F ~ 140°F)
Dimensions (mm)	Width	353
	Height	659
	Depth	142
Weight (kg)		16
Connections	Gas	1/2 po.NPT
	Cold Water Supply	1/2 po. NPT
	Hot Water Supply	1/2 po. NPT
Ignition System		
Max./Min. Gas Consumption	Natural Gas	100,000 btu/h-20,000 Btu/hr
	Propane Gas	97,000 btu/h-20,000 Btu/hr
Hot Water Delivery Capacity Max.		
Noise level		
Thermal efficiency		
NOXaf		
Minimum Operating Water Flow		
Minimum Operating Pressure		
Power Supply		120 Vac/60Hz/1A, one phase
Water temperature control		
Water flow control		
Safety Device	Flame Failure	Flame rod
	Boil dry	Water flow sensor /221°F thermistor

DIMENSIONS

	Over temperature	185°F (Integrated circuit system)
	Fusible link	320°F Thermal Fuse
	Pressure relief valve	Opens 125 PSI
	Combustion fan rpm check	Integrated circuit system
	Over current	Glass fuse (5 Amp/5 Amp)
Remote Controller Cable Optional	K kitchen/Bathroom/Second Bathroom (universal / Up to 3 Controllers)	Kitchen/Bathroom/Second Bathroom (universal / Up to 3 Controllers)
Electrical Consumption (Normal)		30 W

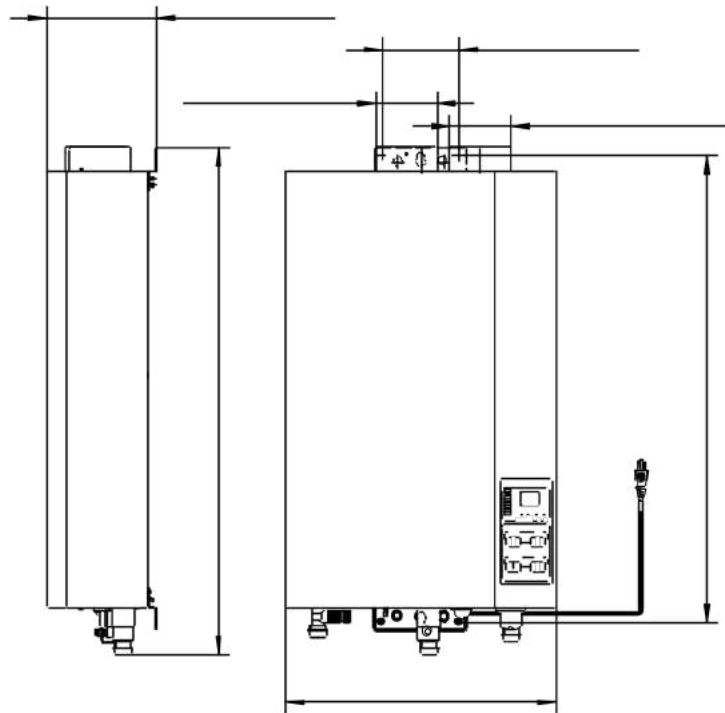

NAMES OF MAJOR PARTS AND COMPONENTS

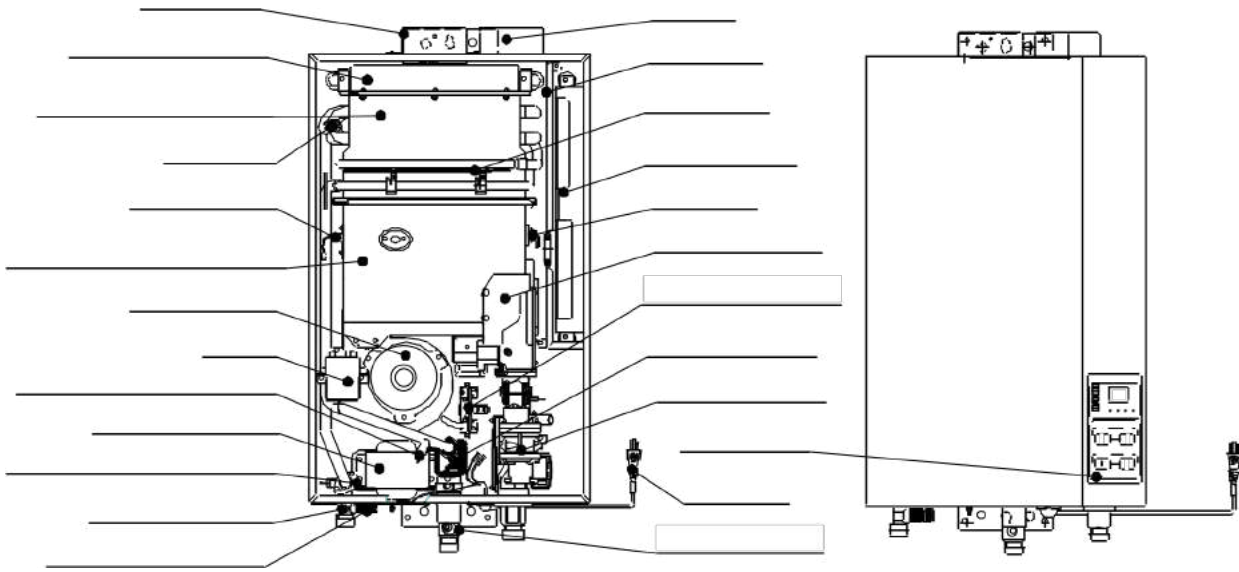

SPARE PARTS

The following spare parts are available for purchase and maybe replaced by a licensed professional. Please contact Marey Heater Corp.

Control Panel	AHG42CP
Wall mount kit (brackets and screws)	AHG42WM
Control printed circuit board (PCB)	AHG42PCB
temperature sensor	AHG42TS
Water flow regulator	AHG42FS1
transformer	AHG42TFM
Heating element	AHG42HEA
discharge pipe	AHG42ED
Draft hood	AHG42FCH
thermostat	AHG42T2
Combustion	AHG42CCA
Combustion blower	AHG42CF
Pilot burner	AHG42IG
Purge water valve	AHG42OWV
Pressure relief valve	AHG42PRV
Air duct	AHG42AD
heat shield	AHG42HS
thermal fuse	AHG42TF
flame rod	AHG42FR
collector device	AHG42MS
collector device	AHG42WPS
proportional valve	AHG42PV
Power cord	AHG42PC
Water inlet valve	AHG42IWV

Limited Warranty

Register unit at: <http://www.marey.com>

General

The manufacturer warrants this water heater and its components to be free from defects in material and workmanship according to the terms herein.

For full warranty details visit <http://www.marey.com>

Exclusion

THIS LIMITED WARRANTY SHALL BE THE EXCLUSIVE WARRANTY MADE BY THE MANUFACTURER AND IS MADE IN LIEU OF ALL OTHER WARRANTIES, EXPRESSED OR IMPLIED (WHETHER WRITTEN OR ORAL), INCLUDING, BUT NOT LIMITED TO, WARRANTIES OF MERCHANTABILITY AND FITNESS FOR A PARTICULAR PURPOSE. THE REMEDIES SET FORTH HEREIN ARE THE ONLY REMEDIES AVAILABLE TO THE OWNER OR ANY PERSON. The company does not authorize any person or company to assume any obligation or liability in connection with the repair or replacement. Manufacturer shall not be liable for any incidental, consequential, special or contingent damages or expenses arising, directly or indirectly, from any defect in the water heater or the use of the water heater. Manufacturer shall not be liable for any water damage arising, directly or indirectly, from any defect in the water heater component part(s) or from its use.

Manufacturer shall not be liable under this warranty if the water heater is subjected to any of the following conditions.

☐

- Misuse, alteration, unauthorized repair, neglect, accident☐
- Has not been installed in accordance with the applicable local plumbing and/or building Code (s) and/or regulation(s)
- Is not continuously supplied with potable water
- Has been operated while frozen
- Is exposed to inlet temperatures above 125°F (52°C)
- Exposed to water pressures above pressure rating of 150 psig (1.0 MPa)
- Used for service in a spa, pool, boat or water craft

SOME STATES DO NOT ALLOW THE EXCLUSION OR LIMITATION OF INCIDENTAL OR CONSEQUENTIAL DAMAGES, SO THE ABOVE LIMITATION OR EXCLUSION MAY NOT APPLY TO YOU. THIS WARRANTY GIVES YOU SPECIFIC LEGAL RIGHTS ET YOU MAY ALSO HAVE OTHER RIGHTS WHICH MAY VARY FROM STATE TO STATE.

Making a Claim

Owner should submit the warranty claim directly to Marey Heater Corp. by contacting us at the phone number shown below. If you are advised to return the unit, you must obtain a Returned Materials Authorization (RMA) over the phone BEFORE RETURNING THE UNIT. When contacting the company please have the unit's serial number and original purchase receipt on hand to provide purchase date and other necessary information. Package the heater well to prevent damage, tag the heater with the RMA number and ship the water heater prepaid to Marey Heater Corp. as instructed. Unauthorized returns may be rejected at the company's discretion.



U.S.A
+1 (855) MAREY-55
(627-3955)

PUERTO RICO
(787) 727-0277

customerservice@marey.com

www.Marey.com