

QUICK-START GUIDE

EG4® WALLMOUNT INDOOR 280Ah LITHIUM BATTERY



This guide has been created to give the end-user a quick and easy process to install and commission the WallMount Indoor 280Ah lithium battery in a variety of configurations.



TABLE OF CONTENTS

1.	TECHNICAL SPECIFICATIONS	1
2.	ABBREVIATIONS.....	3
3.	SAFETY.....	4
3.1	SAFETY INSTRUCTION	4
3.2	IMPORTANT SAFETY NOTIFICATIONS.....	4
4.	PACKING LIST.....	6
4.1	LOCATION SELECTION AND INSTALLATION	6
5.	PARALLEL EXAMPLES.....	7
5.1	BATTERY CABLE CONNECTIONS.....	7
5.2	ADDITIONAL CONFIGURATIONS	8
6.	ORIENTATION EXAMPLES.....	11
7.	INSTALLING THE BATTERY.....	12
7.1	STANDALONE BATTERY INSTALL	12
7.2	BATTERY INSTALL WITH CONDUIT BOX.....	12
7.3	BATTERY INSTALL WITH CONDUIT BOX & EG4 INVERTER	13
7.4	PRE-WIRE STEPS AND WIRING	14
7.5	MULTIPLE BATTERY PARALLEL INSTALL.....	15
7.6	MULTIMETER TESTING AND WIRING.....	16
8.	FRONT PANEL INDICATOR LIGHTS.....	17
8.1	RUN/ALM LIGHTS.....	17
8.2	SOC INDICATOR LIGHTS.....	17
9.	BMS COMMUNICATIONS.....	18
9.1	CLOSED LOOP COMMUNICATIONS	18
10.	FIRMWARE UPDATES	20

1. TECHNICAL SPECIFICATIONS

MODULE OPERATING PARAMETERS			
PARAMETER	BMS		RECOMMENDED SETTING
TOTAL ENERGY CAPACITY	14.3kWh @25C, 100% SOC		-
VOLTAGE	51.2V		
CAPACITY	280Ah		-
CHARGING VOLTAGE (BULK/ABSORB)	56.0V (+/-0.8V)		56.2V (+/-0.2V)
FLOAT	-		54V (+/-0.2V)
LOW DC CUTOFF	44.8V		47-45.6V (start high, lower as needed)
CHARGING CURRENT	200A (Max. continuous)		60A - 160A
DISCHARGING CURRENT	200A (Max. continuous)		160A
DISCHARGE RATE	10.24kW (Max. continuous)		-
ENVIRONMENTAL PARAMETERS			
CHARGING RANGE	32° to ≈113°F (0°C to ≈45°C)		
DISCHARGING RANGE	-4°F to ≈122°F (-20°C to ≈50°C)		
STORAGE RANGE	-4°F to ≈122°F (-20°C to ≈50°C)		
INGRESS PROTECTION	IP20		
CHARGING/ DISCHARGING PARAMETERS			
CHARGE	SPEC	DELAY	RECOVERY
CELL VOLTAGE PROTECTION	3.8V	1 sec	3.45V
MODULE VOLTAGE PROTECTION	60.0V	1 sec	55.2V
OVER CHARGING CURRENT 1	>205A	10 sec	-
OVER CHARGING CURRENT 2	>225A	3 sec	-
TEMPERATURE PROTECTION	<23°F or >158°F <-5°C or >70°C	1 sec	>32°F or <140°F >0°C or <60°C
DISCHARGE	SPEC	DELAY	RECOVERY
CELL VOLTAGE PROTECTION	2.3V	1 sec	3.1V
MODULE VOLTAGE PROTECTION	44.8V	1 sec	48V
OVER-CHARGING CURRENT 1	>205A	10 sec	60 sec
OVER-CHARGING CURRENT 2	>300A	3 sec	60 sec
SHORT CIRCUIT	>600A	<0.1 mS	-
TEMPERATURE PROTECTION	<-4°F or >167°F <-20°C or >75°C	1 sec	>14°F or <149°F >-10°C or <65°C
PCB TEMP PROTECTION	>230°F (>110°C)	1 sec	@ <176°F (<80°C)
GENERAL SPECIFICATIONS			
PARAMETER	SPEC		CONDITION
CELL BALANCE	120mA	Passive Balance	Cell Voltage Difference >40mV
TEMPERATURE ACCURACY	3%	Cycle Measurement	Measuring Range -40°F to ≈212°F (-40°C to ≈100°C)
VOLTAGE ACCURACY	0.5%	Cycle Measurement	For Cells & Module
CURRENT ACCURACY	3%	Cycle Measurement	Measuring Range -200A - 200A
SOC	5%	-	Integral Calculation
POWER CONSUMPTION	Sleep & Off Mode	<300uA	Storage/Transport/Standby
POWER CONSUMPTION	Operating Mode	<25mA	Charging/Discharging
COMMUNICATION PORTS	RS485/CAN		Can be customized
BATTERY HEATER SPECIFICATIONS			
PARAMETER	SPEC		CONDITION
VOLTAGE	56V		-
POWER CONSUMPTION	224W		-
INTERNAL BATTERY TEMPERATURE	≤32°F (0°C)≥41°F (5°C)		Heat On/Heat Off

PHYSICAL SPECIFICATIONS

DIMENSIONS (H×W×D) 36.4 in.×18.1 in.×9.6 in. (925 mm×460 mm×245 mm)

WEIGHT 282.2 lbs. (128 kg)

DESIGN LIFE >15 Years

CYCLE LIFE >8000 Cycles, 0.5C 80% DOD

LIFETIME PRODUCTION 82.6MWh*

SAFETY CERTIFICATIONS

CERTIFICATIONS UL1973, UL 9540A (Passed)

**(51.2V×280Ah/1000×80%×8000 cycles/1000)90%=MWh*

2. ABBREVIATIONS

AWG – American Wire Gauge

A – Amp(s)

Ah – Amp hour(s)

AC – Alternating Current

AFCI-Arc-Fault Circuit Interrupter

AHJ – Authority Having Jurisdiction

ANSI – American National Standards Institute

BAT-Battery

BMS – Battery Management System

COM-Communication

CT-Current Transformer

DC – Direct Current

DIP – Dual In-line Package

DOD – Depth of Discharge

EG – Equipment Ground

EGS – Equipment Grounding System

EMC-Electromagnetic Compatibility

EPS – Emergency Power System

ESS – Energy Storage System

E-Stop-Emergency Stop

E-Stop NO – Emergency Stop Normally Open

FCC-Federal Communication Commission

GE – Grounding Electrode

GEC – Grounding Electrode Conductor

GEN-Generator

GES – Grounding Electrode System

GFCI-Ground Fault Circuit Interrupter

GFDI-Ground Fault Detector/Interrupter

Imp – Maximum Power Point Current

IEEE-Institute of Electrical and Electronic Engineers

IP-Ingress Protection

Isc – Short-Circuit Current

In-lbs. – Inch Pounds

kW – Kilowatt

kWh – Kilowatt-hour

LCD-Liquid Crystal Display

LFP – Lithium Iron Phosphate or LiFePO₄

L1-Line 1; Typically, a black wire

L2-Line 2; Typically, a red wire

mm – Millimeter(s)

MPPT-Maximum Power Point Tracking

mV – Millivolt(s)

N-Neutral; Typically, a white wire

NEC – National Electrical Code

NEMA- National Electrical Manufacturers Association

NFPA – National Fire Prevention Association

Nm – Newton Meters

NOCT-Normal Operating Cell Temperature

PC – Personal Computer

PCB – Printed Circuit Board

PE – Protective Earth (G or Ground);

Pnum-Parallel Number

PPE – Personal Protective Equipment

PV – Photovoltaic

RSD – Rapid Shut Down

SCC- Standards Council of Canada

SOC – State of Charge

STC – Standard Testing Conditions

UL-Underwriters Laboratories

UPS-Uninterrupted Power Supply

V – Volt(s)

VOC – Open-Circuit Voltage

VMP – Voltage Maximum Power

3. SAFETY

3.1 SAFETY INSTRUCTION

Before any work begins, carefully read all safety instructions, and always observe them when working on or with the battery. The installation must follow all applicable national or local standards and regulations. Consult with the local AHJ to obtain the proper permits and permissions before installation.

Incorrect installation may cause:

- *Injury or death to the installer, operator or third party*
- *Damage to the battery or other attached equipment*

3.2 IMPORTANT SAFETY NOTIFICATIONS

There are various safety concerns that must be carefully observed before, during, and after the installation, as well as during future operation and maintenance. The following are important safety notifications for the installer and any end users of this product under normal operating conditions.



DANGER!

AVERTISSEMENT!

High Voltages and Large Current!

Circuits à tension élevée!

1. **Do not disassemble the battery.** Contact the distributor for any issues that need repair for more information and proper handling instructions. Incorrect servicing or re-assembly may result in a risk of electric shock or fire and void the warranty.
2. **Never short-circuit DC inputs.** Short-circuiting the battery may result in a risk of electric shock or fire and can lead to severe injury or death and/or permanent damage to the unit and/or any connected equipment.
3. **Use caution when working with metal tools on or around batteries and systems.** Risk of electrical arcs and/or short circuiting of equipment can lead to severe injury or death and equipment damage.
4. **Beware of high battery current.** Please ensure that the battery module breakers and/or on/off switches are in the “open” or “off” position before installing or working on the battery. Use a voltmeter to confirm there is no voltage present to avoid electric shock.
5. **Do not make any connections or disconnections to the system while the batteries are operating.** Damage to system components or risk of electrical shock may occur if working with energized batteries.
6. Make sure the battery and rack are properly grounded.
7. An installer should make sure to be well protected by reasonable and professional insulative equipment [e.g., personal protective equipment (PPE)].
8. Before installing, operating, or maintaining the system, it is important to inspect all existing wiring to ensure it meets the appropriate specifications and conditions for use.
9. Ensure that the battery and system component connections are secure and proper to prevent damage or injuries caused by improper installation.



WARNING: *To reduce the risk of injury, read all instructions!*

All work on this product (system design, installation, operation, setting, configuration, and maintenance) must be carried out by qualified personnel. To reduce the risk of electric shock, do not perform any servicing other than those specified in the operating instructions unless qualified to do so.

1. Read all instructions before commencing installation. For electrical work, follow all local and national wiring standards, regulations, and these installation instructions. All wiring should be in accordance with the National Electrical Code (NEC), ANSI/NFPA 70.
2. The battery and system can connect with the utility grid only if the utility provider permits. Consult with the local AHJ before installing this product for any additional regulations and requirements for your area.
3. All warning labels and nameplates on this battery should be clearly visible and must not be removed or covered.
4. The installer should consider the safety of future users when choosing the battery's correct position and location as specified in this manual.
5. Please keep children away from touching or misusing the battery and relevant systems

DISCLAIMER

EG4 reserves the right to make changes to the material herein at any time without notice.

Please refer to www.eg4electronics.com for the most updated version of our manuals/spec sheets.

4. PACKING LIST

The items listed below will arrive with the product shipment:

EG4 WallMount Indoor 280Ah

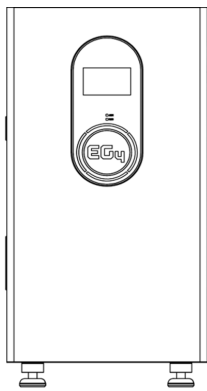

(1) EG4 WallMount Indoor 280Ah

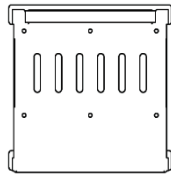

(1) Mounting Bracket*

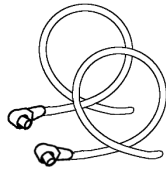

(2) Red power cables
2/0 AWG (39.4 in.)

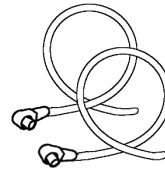

(2) Black power cables
2/0 AWG (39.4 in.)



(6) Concrete Expansion Bolts



(1) Battery to Inverter Communication Cable

***The included mounting bracket will arrive attached to the back of the battery**

4.1 LOCATION SELECTION AND INSTALLATION

Requirements for installation location:

- The WallMount Indoor battery is heavy. Use a lift or other equipment to lift and carry the unit.
- The battery can be installed against a flat wall, but the weight of the battery should not be fully supported by the wall. To help with this requirement, the battery comes with pre-installed feet that should be used to carry the weight of the battery.
- If the battery is installed against a wall, the wall should be made of non-combustible material. If this is not possible, then the unit **MUST** have a minimum of 2 in. (50.8mm) clearance from the wall. Also note that whatever mounting solution that is used to grant the 2 in. clearance from the wall **MUST** be made of a non-combustible material.
- If installing on flat ground as a standalone unit, ensure there is proper drainage on the ground surrounding the battery to maintain integrity of the module over time and prevent damage from flooding. If installing against a wall, ensure at least a 7 in. (305mm) gap on each side of the unit for adequate airflow and operations.
- Ensure the battery is mounted upright.



NOTE: *The battery will be shipped with temporary lifting handles for removing the battery from its packaging. The battery is very heavy. Use the team-lift technique during installation and remove the temporary lifting handles before making any connections within the system.*



WARNING: Please be sure not to make any electrical connections until the system is properly placed where it will operate.

5. PARALLEL EXAMPLES

The diagrams below show different parallel orientations. These diagrams are for reference only!

5.1 BATTERY CABLE CONNECTIONS

The following battery cable connection diagrams are examples using the internal busbars to parallel the batteries together and attach the inverter(s) to the batteries. When relying on the internal busbars, up to 3 batteries are supported in parallel when connected to a single inverter, 4 batteries in parallel when connected to 2 inverters, or up to 5 batteries in parallel when connected to 3 inverters.

Systems with more batteries than these configurations require the use of an external fused positive busbar and an unfused negative busbar rated at a minimum of 200A per battery. Each fuse should be a maximum of 250A. Alternatively, larger systems could rely on the 18kPV's ability to draw from different battery packs while still paralleling inverters rather than utilizing external busbars.

The maximum recommended number of paralleled 18kPV inverters is 6. If this approach is used, we recommend a ratio of 2 batteries per pack controlled by each 18kPV inverter. Separating packs is only recommended if each pack's average SOC is monitored over time and does not diverge by more than 10%. Common busbars are superior to separating battery packs but it may be difficult to source fused positive busbars rated to greater than 1800 Amps. This translates into separating packs larger than 9 batteries. Refer to NEC code and the local AHJ for exact requirements.



NOTE: In the following diagrams, units are spaced 7 in. apart. Local regulations may require a larger minimum battery spacing. Check with the local AHJ for these requirements. If longer parallel cables than are available in the optional paralleling kit are necessary, please check with the distributor for availability.

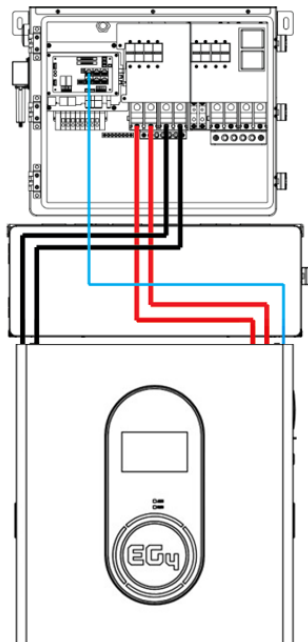

Note: To comply with the UL9540 listing for this integrated battery, conduit box, and inverter system, the batteries must be wired as shown using the supplied inverter to battery cables. An additional paralleling kit is required for each additional paralleled battery (sold separately).



Caution: To minimize voltage drop in the wire, the battery cables should maintain optimum length. The 53.1 in. cables from the "parallel kit" are sufficient to daisy chain the batteries.

Figure 1 – (1) 18kPV with (1) WallMount

5.2 ADDITIONAL CONFIGURATIONS



Note: Some configurations require additional wiring/connectors to achieve the example layouts. Inverter to inverter paralleling cables are not shown in the following diagrams. Other configurations can be achieved by using external busbars. Please seek the guidance of an electrician or qualified personnel for optional system layout.

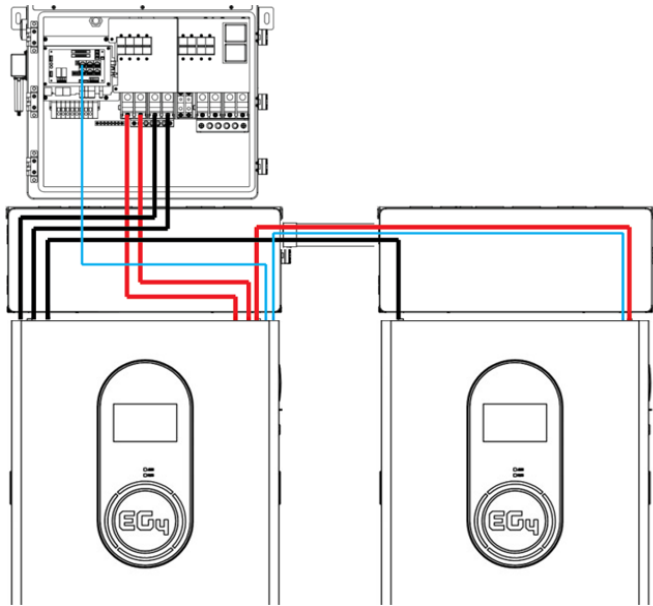

Figure 2 – (1) 18kPV with (2) WallMount

Pro Tip: One EG4-18kPV and a minimum of 2 WallMount units is the recommended configuration to maximize the system's functionality.

Color Code

	Parallel/Comms
	Positive
	Negative



Reminder!
The separation between batteries should be ≥ 7 in.

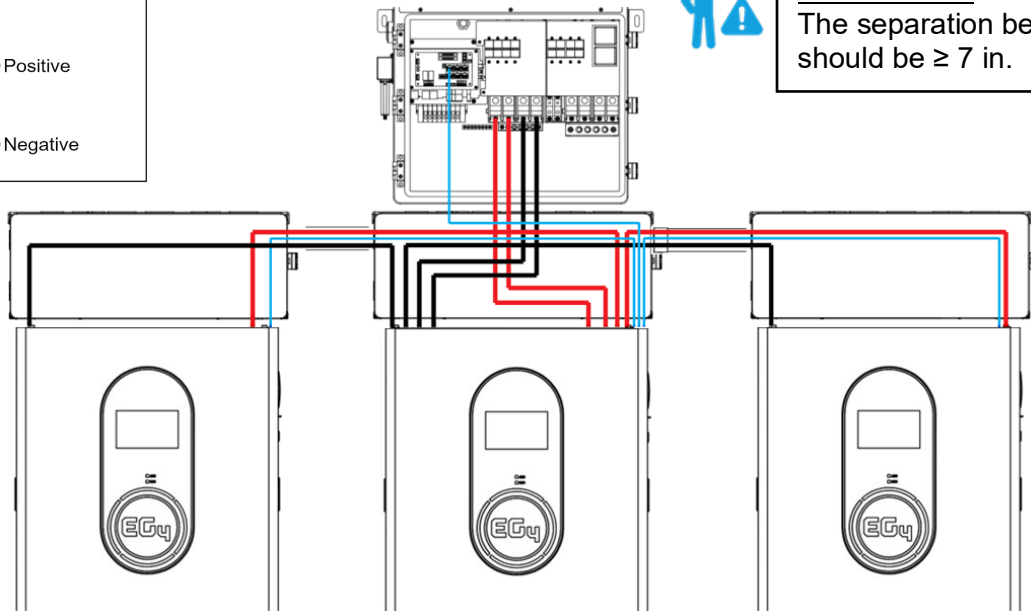

Figure 3 – (1) 18kPV with (3) WallMount

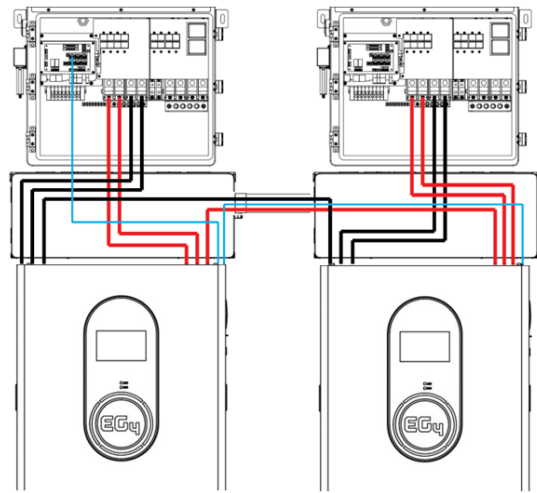

Figure 4 – (2) 18kPV with (2) WallMount

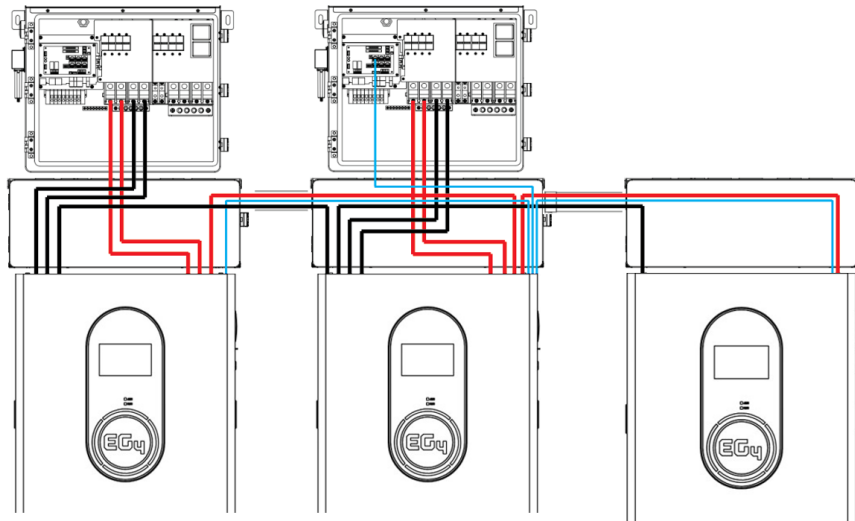

Figure 5 – (2) 18kPV with (3) WallMount

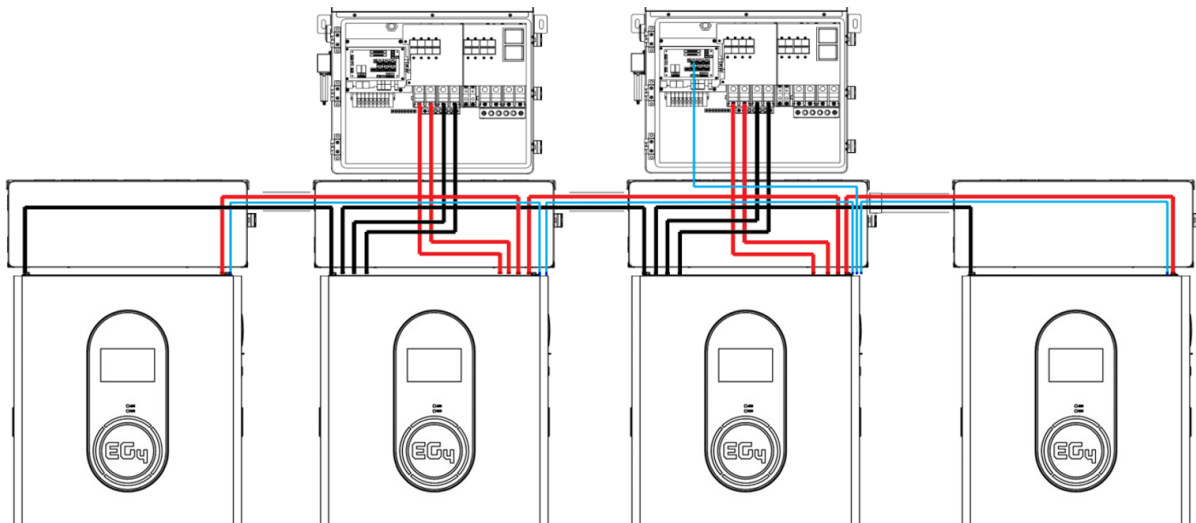

Figure 6 – (2) 18kPV with (4) WallMount

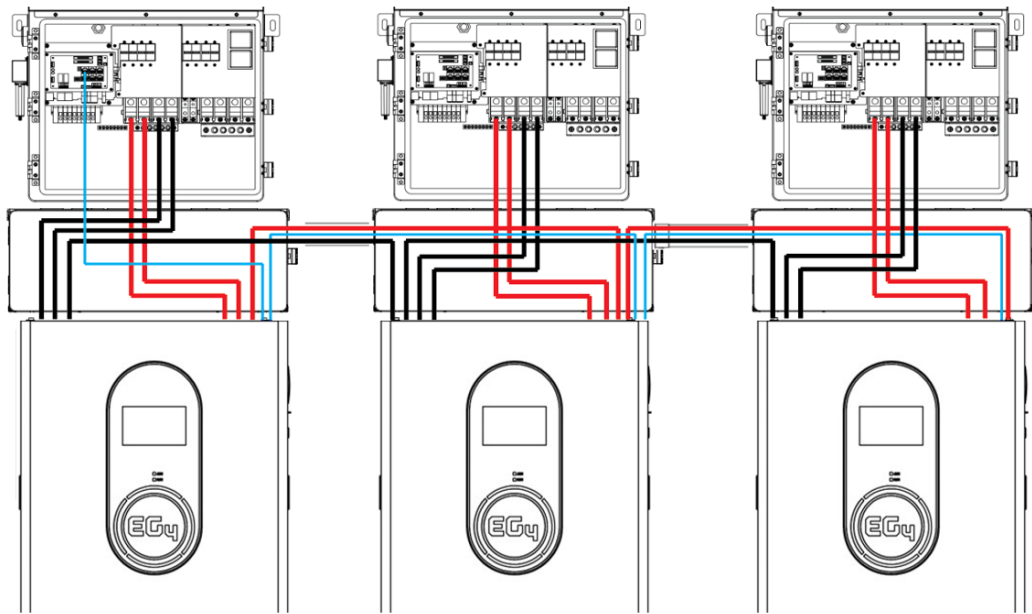

Figure 7 - (3) 18kPV with (3) WallMount

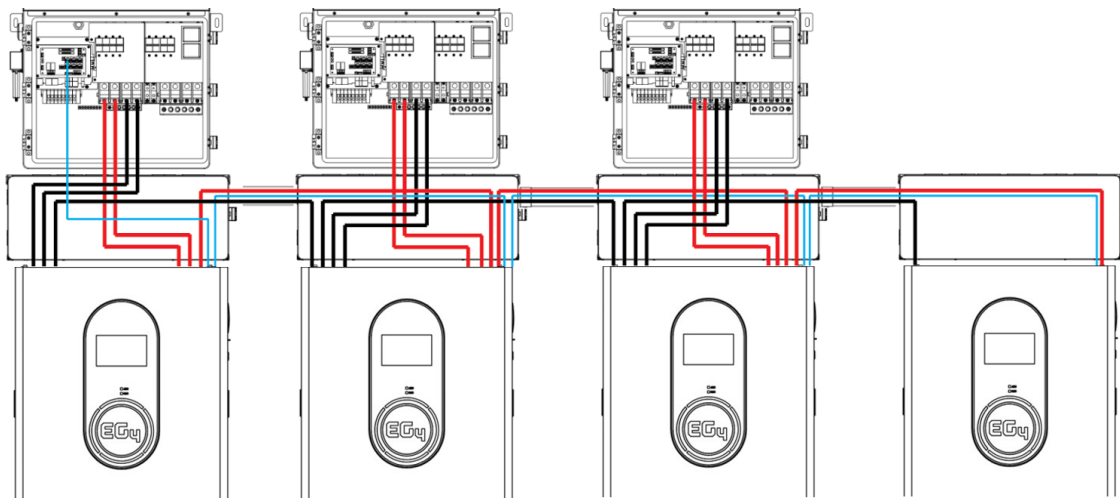
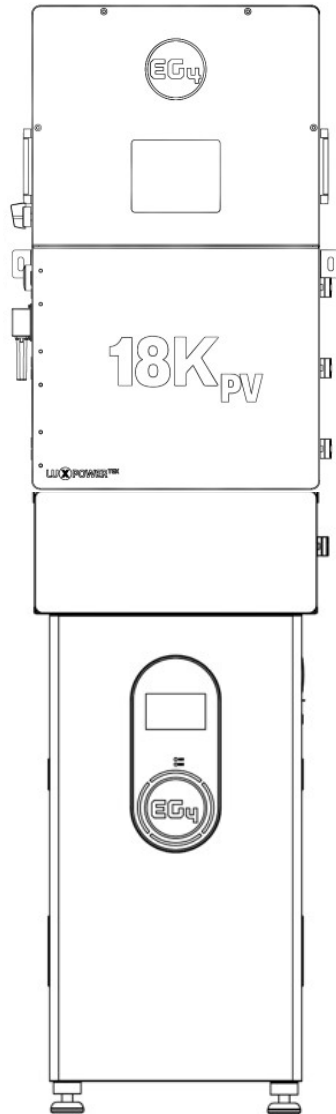

Figure 8 - (3) 18kPV with (4) WallMount

For more information on connecting and paralleling this battery, please use the QR code below to navigate to the Connection Overview & Paralleling Guide.



6. ORIENTATION EXAMPLES



(1) 18kPV Inverter +
(1) WallMount Indoor
Battery

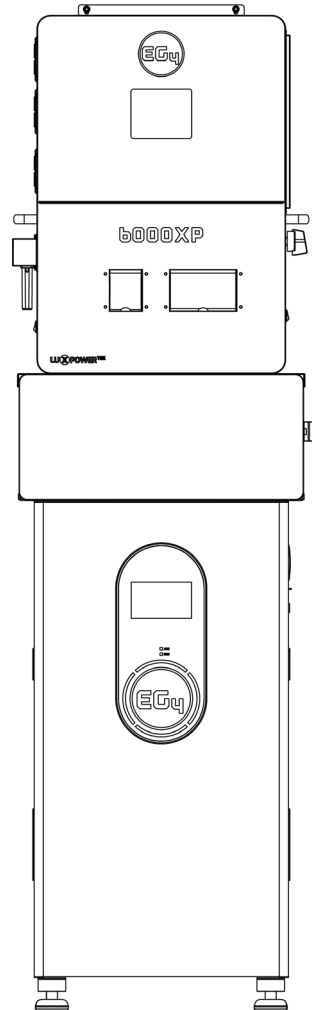

(1) 6000XP Inverter +
(1) WallMount Indoor
Battery

7. INSTALLING THE BATTERY

Follow the steps listed below to ensure the WallMount Indoor battery is mounted correctly.



WARNING: Do not put EG4 WallMount batteries in series!

The BMS and internal components are not designed to handle this setup, which could cause the modules to fail, leading to damage.



NOTE: The battery will be shipped with temporary lifting handles for removing the battery from its packaging. EG4 recommends these handles be removed before mounting to the wall making any connections.

7.1 STANDALONE BATTERY INSTALL

1. Remove the 4 set screws holding the mounting bracket to the back of the battery pack and set them to the side.
2. Remove the mounting bracket from the battery.
3. Position the top of the mounting bracket on the wall at the desired mounting height, with a minimum clearance from the ground of 29.2 in. (742mm).
4. Using a level, ensure the bracket is level and drill 6 holes to accommodate the mounting hardware used.
5. Secure the mounting bracket to the wall using the included expansion bolts or appropriate hardware required for the mounting surface.
6. Attach the battery pack to the mounting bracket. Using the team-lift technique, lift the battery and hook the back flange onto the front flange of the mounting bracket.
7. Secure the battery to the mounting bracket using the 4 included side screws.
8. Finally, properly ground the battery, attaching a grounding conductor to the M6 grounding screw on top of the battery to the Equipment Grounding System. **DO NOT GROUND THE NEGATIVE BATTERY CABLE!**

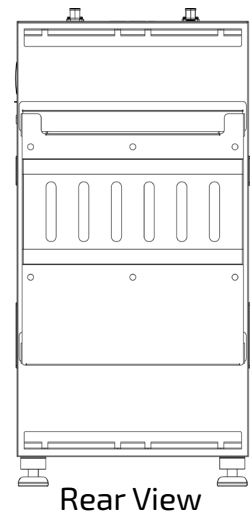

7.2 BATTERY INSTALL WITH CONDUIT BOX

1. Remove the 4 set screws holding the mounting bracket to the back of the battery pack and set them to the side.
2. Remove the mounting bracket from the battery.
3. Position the top of the mounting bracket on the wall at the desired mounting height, with a minimum clearance from the ground of 29.2 in. (742mm).
4. Using a level, ensure the bracket is level and drill 6 holes to accommodate the mounting hardware used.
5. Secure the mounting bracket to the wall using the included expansion bolts (concrete or brick walls) or appropriate hardware for the mounting surface.
6. Attach the battery to the mounting bracket. Using the team-lift technique, lift the battery and hook its back flange onto the front flange of the mounting bracket.
7. Secure the battery to the mounting bracket using the 4 included side screws.
8. Remove the four screws on the top of the battery as shown in Section 7.3 and retain them for use in Step 9.
9. Identify the four screws locations shown in Section 7.3 that line up with the thumb screws located in Step 8. Place the conduit box on top of the battery and use the thumb screws to attach the box to the top of the battery.
10. Finally, properly ground the battery, attaching a grounding conductor to the M6 grounding screw on top of the battery to the equipment grounding system. **DO NOT GROUND THE NEGATIVE BATTERY CABLE!**

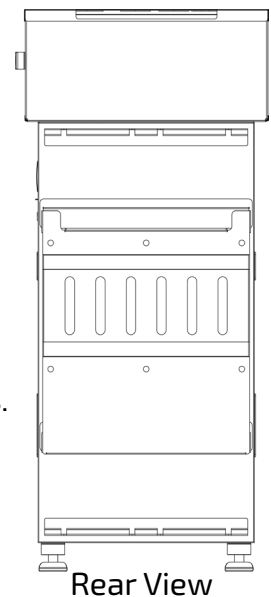

NOTE: If mounting the bracket at 29.2 in. (742mm) from the ground, the battery will rest on the ground.

7.3 BATTERY INSTALL WITH CONDUIT BOX & EG4 INVERTER

The WallMount Indoor battery is designed to integrate with the EG4 18kPV hybrid inverter, as well as the 6000XP off-grid inverter.

Follow the steps listed below to ensure proper connections are made in the system:

1. Remove the 4 set screws holding the mounting bracket to the back of the battery pack and set them to the side.
2. Remove the mounting bracket from the battery.
3. Position the top of the mounting bracket on the wall at the desired mounting height, with a minimum clearance from the ground of 29.2 in. (742mm).
4. Using a level, ensure the bracket is level and drill 6 holes to accommodate the mounting hardware used.
5. If using a 18kPV, align the provided X-bracket with the holes on the mounting bracket and secure both to the wall, using the included expansion bolts (concrete/brick walls) or appropriate hardware required for the mounting surface. The X-bracket will rest behind the mounting plate, against the wall.
6. Remove the four screws on the top of the battery as shown below and retain them for use in Step 7. See the below image for reference.
7. Identify the four screws locations shown below that line up with the thumb screws located in Step 6. Place the conduit box on top of the battery and use the thumb screws to attach the box to the top of the battery. See the below image for reference.
8. Attach the inverter to the inverter mounting bracket and ensure the inverter's bottom knockouts align with the conduit box. If using a 6000XP, it will not have a mounting bracket of its own. It has two mounting ears which are already attached (one on top and one on bottom), each with 3 screw holes, that are used to mount the unit to the wall. The bottom mounting ear will fit behind the conduit box once it is in place on the wall, and the 3 screw holes can be accessed from inside the conduit box.
9. Finally, properly ground the battery, attaching a grounding conductor to the M6 grounding screw on top of the battery to the equipment grounding system. **DO NOT GROUND THE NEGATIVE BATTERY CABLE!**

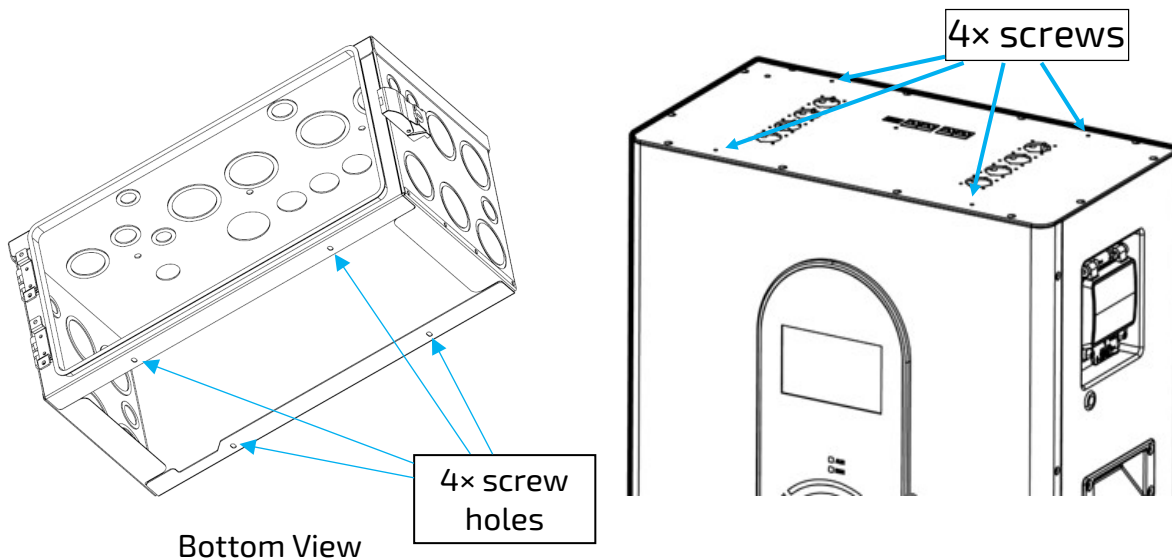
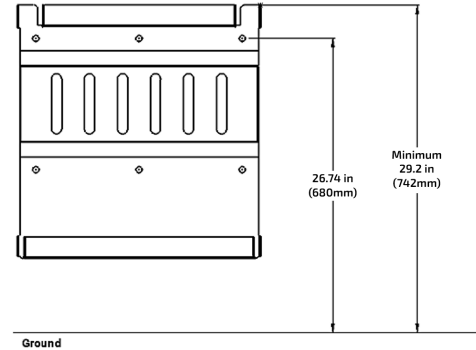

The image below represents a completed install showing a rear view.

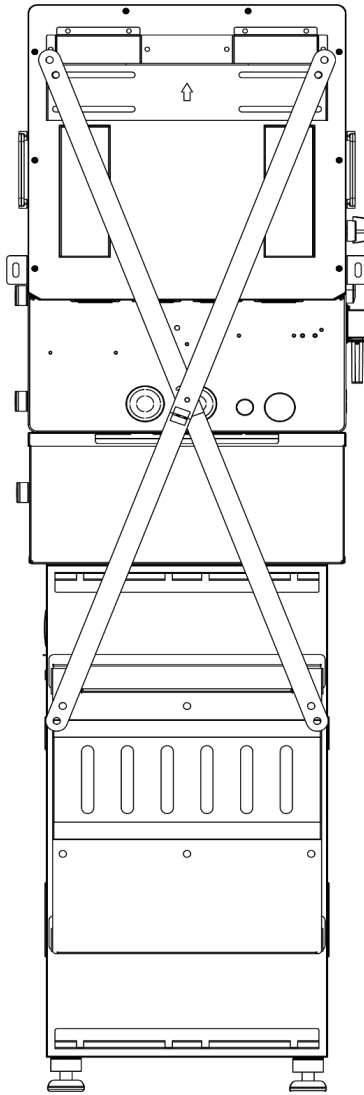

Rear View

7.4 PRE-WIRE STEPS AND WIRING

The battery will come with 2 sets of 2/0 AWG power cables. Please refer to the inverter documentation that the battery will be connected to for torque specs and wire sizing needs for specific use cases.

7.5 MULTIPLE BATTERY PARALLEL INSTALL



WARNING: Make sure to install the communication cables into their respective ports! Improper installation may lead to component damage! EG4 recommends double checking all points of connection before introducing power to the system to mitigate any potential issues.



IMPORTANT:

The battery can charge/discharge up to 200A before the BMS shuts off the pack. Ensure the inverter is configured to handle this high of a current and size all wires accordingly! Refer to an NEC approved ampacity chart or consult with the installer or a solar electrician for more information.

When paralleling multiple WallMount Indoor batteries, a paralleling kit must be purchased through the distributor.

Follow the steps outlined below to ensure proper installation of multiple batteries in parallel.

1. Ensure all circuit breakers are open (off). Using a multimeter, check for voltage at all available disconnects and lines. Once no voltage is confirmed, proceed to the next step.
2. Set the DIP switch address on the master battery to address 1, and all other batteries in parallel to differing addresses going in ascending order. (See image) →
3. Reset the battery BMS via the power button to register the address change.
4. Set up communication between the batteries via the “Battery-Comm” ports by using a CAT 5, 5e, or 6 cable.

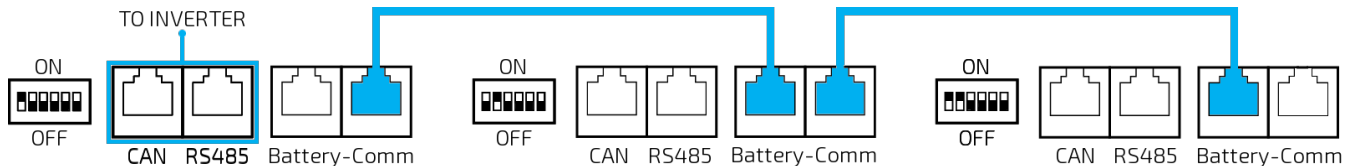
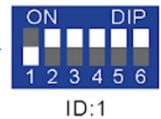

5. The battery set to address 1 will connect directly to the inverter BMS communication port via CAT 5, 5e or CAT 6 cable.
6. Install battery paralleling cables between the batteries included in the optional paralleling kit ensuring the connectors are seated properly.

For more information on connecting and paralleling this battery, please use the QR code below to navigate to the Connection Overview & Paralleling Guide.



7.6 MULTIMETER TESTING AND WIRING



DANGER! *No connections should be made until proper polarity of cables has been confirmed!*



WARNING: *Make sure to install the communication cables into their respective ports! Improper installation may lead to component damage!*

EG4 recommends double checking all points of connection before introducing power to the system to mitigate any potential issues.

Follow the steps outlined below to both test the inputs and wire the battery pack to the inverter.

1. Ensure all circuit breakers are open (off). Using a multimeter, check for voltage at all available disconnects and lines. Once no voltage is confirmed, proceed to the next step.
2. Connect the included sets of 2/0 AWG (70mm²) connectors to the battery's positive and negative terminals. The connectors will "click" when seated properly.



NOTE: *If installing the battery pack with the optional conduit box, secure the conduit fittings to the enclosure using the counter nuts after step 2.*

3. If applicable, route the battery power cables through the conduit box to the inverter **without making any connections!**
4. Ensure proper polarity of cables. Once confirmed, proceed to the next step.
5. Install the positive battery cable(s) to the inverter's positive battery terminals following proper torque values.
6. Install the negative battery cable(s) to the inverter's negative battery terminals following proper torque values.

8. FRONT PANEL INDICATOR LIGHTS

8.1 RUN/ALM LIGHTS

The WallMount Indoor 280Ah lithium battery features 2 LED status indicator lights on the front panel of the unit. Their functions are listed below:



ALM – The ALM light indicates a static, red color and powers on when a fault occurs. Please refer to the Troubleshooting & Maintenance Guide for more information on specific faults and required actions.

RUN – The RUN light will indicate a solid, green color when the battery is in an idle state. When the battery is either charging or discharging, the light will indicate a blinking, green color.

Light Description	Indication	Color	Indication Description
ALM	Static	Red	A fault has occurred
	Static	Green	Battery is in the idle state
RUN	Blinking	Green	Battery is charging/discharging

8.2 SOC INDICATOR LIGHTS

The unit also features a ring of LED lights surrounding the EG4 logo that indicate the SOC (state of charge) of the unit. The table below provides detailed logic of the LED lights.

SOC	Number of LEDs	Color
0%-15%	1 (lower quadrant)	Red
16%-25%	1 (lower quadrant)	Green
26%-50%	2 (lower, left quadrants)	Green
51%-75%	3 (lower, left, right quadrants)	Green
76%-100%	4 (all 4 quadrants)	Green

9. BMS COMMUNICATIONS



WARNING: Make sure to install the communication cables into their respective ports!
 Improper installation may lead to component damage!
 EG4 recommends double checking all points of connection before introducing power to the system to mitigate any potential issues.

EG4 batteries interface with compatible inverters by designating a “Master” battery (DIP switch ID No. 1).



The battery will connect directly to the inverter via an RS485 battery communications cable or a standard CAT 5, 5e, or 6 cable for closed loop communications with supported EG4 and non-EG4 inverters using CAN bus protocol.

The PC software “BMS TOOLS” provides real-time battery analysis and diagnostics. The battery cannot communicate with the software and a closed loop inverter simultaneously.

Scan the QR code on the left for a video walking through the BMS Tools setup process.

Scan the QR code on the right for a white sheet walking through the BMS Tools setup process.



9.1 CLOSED LOOP COMMUNICATIONS

1. Power off all battery DC breakers and BMS power buttons.
2. The inverter protocol can only be changed with the master battery temporarily set to address 64 (all switches ON). After the DIP switch is changed, restart the BMS using the BMS power button for the settings to take effect. (See image)
3. On the master battery, press the Settings button (shown below/left), which will take you to the next screen (shown below/right), where you will select either CAN or RS485 protocol.

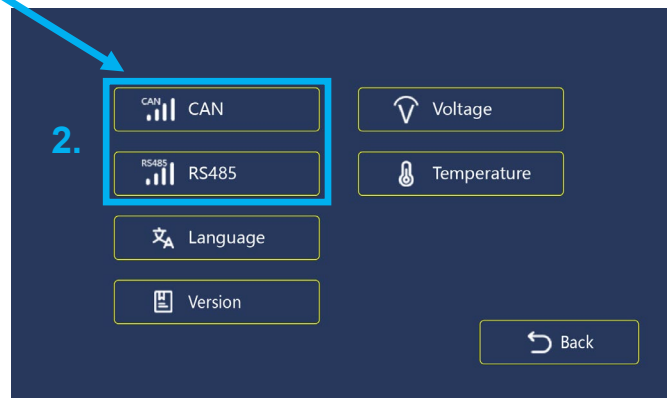
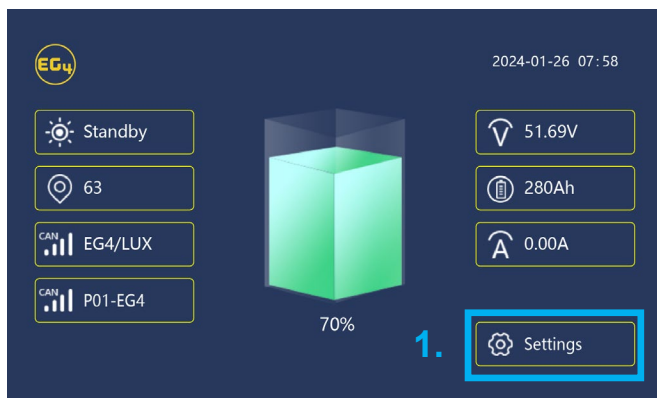

- Selecting CAN or RS485 will take you to a password screen. The default password for each section is "123456".

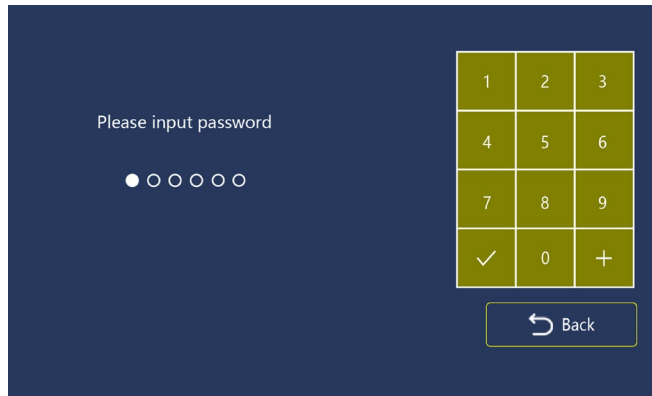

- Select the corresponding CAN protocol (P01-EG4/LUX) for the system if using EG4 inverters, (See table below).
- Change the master DIP switch address back to address 1 for inverter communications & power cycle the BMS. (See image)

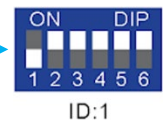

The tables below show compatibility lists depending on the type of communication protocol used for closed-loop communications between battery and inverter.

CLOSED LOOP COMMS. WITH EG4 INVERTERS	
MODEL	PROTOCOL SELECTION
18kPV/6000XP	CAN – P01

CAN PROTOCOL LIST	
PROTOCOL #	MANUFACTURER
P01-EG4/LUX	EG4/LUX
P02-GRW	Growatt
P03-SLK	Sol-Ark
P04-DY	Deye
P05-MGR	Megarevo
P06-VCT	Victron
P07-LUX	Luxpower
P08-SMA	SMA

RS485 PROTOCOL LIST	
PROTOCOL #	MANUFACTURER
P01-EG4	EG4
P02-GRW	Growatt
P03-SCH	Schneider

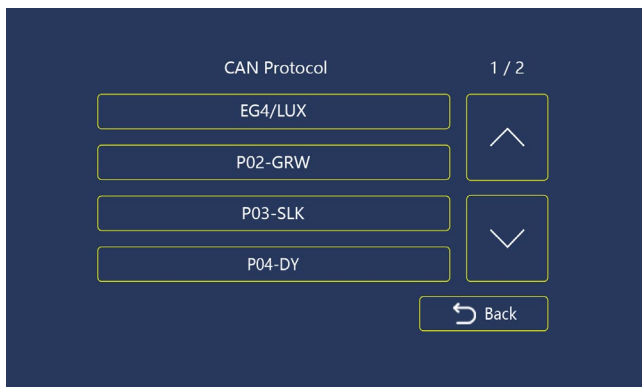
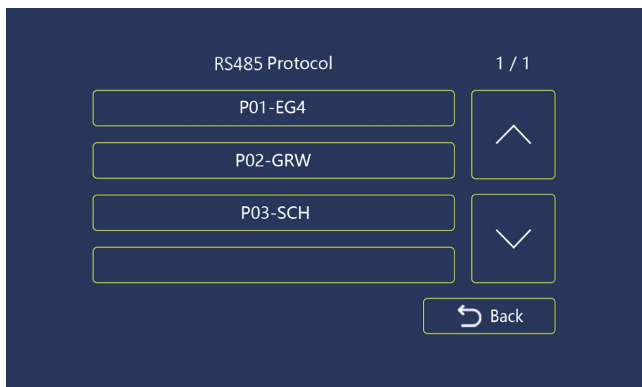

NOTE: Closed loop communications using RS485 protocols require a specific pinout on the comms cable from battery to inverter. Refer to the table below for EG4 specifics.

EG4 INVERTER MODEL	PROTOCOL	COMMUNICATION CABLE PINOUT
18kPV	CAN	To inverter – RJ 45 Pin 4-H & Pin 5-L To battery – RJ 45 Pin 4-H & Pin 5-L
	RS485	To inverter – RJ45 Pins 7-A & 8-B To battery – RJ45 Pins 1-B & 2-A
6000XP	CAN	To inverter – RJ 45 Pin 4-H & Pin 5-L To battery – RJ 45 Pin 4-H & Pin 5-L
	RS485	To inverter – RJ45 Pins 1-B & 2-A To battery – RJ45 Pins 1-B & 2-A
3000EHV (Legacy Product)	RS485	To inverter – USB Type B To battery – RJ45 Pins 1-B & 2-A
8KEXP (Legacy Product)	CAN	To inverter – RJ 45 Pin 4-H & Pin 5-L To battery – RJ 45 Pin 4-H & Pin 5-L
	RS485	To inverter – RJ45 Pins 7-B & 8-A To battery – RJ45 Pins 1-B & 2-A
6000EX (Legacy Product)	RS485	To inverter – RJ45 Pins 3 & 5 To battery – RJ45 Pins 1-B & 2-A
6500EX (Legacy Product)	RS485	To inverter – RJ45 Pins 3 & 5 To battery – RJ45 Pins 1-B & 2-A

10. FIRMWARE UPDATES

Always ensure all system components are fully up to date before commissioning the system. Scan the QR code below to navigate to the Battery Firmware Changelog & Update Guide. If encountering difficulties during the updating process, contact the distributor for more information.



C H A N G E L O G

Version 1.2.4

- Added QR code links to supplemental white sheets

Version 1.2.3

- Technical Specifications table updated to add Total Energy Capacity and Discharge Rate line items.
- Minor formatting changes

Version 1.2.2

- Section 9.1 edited to reflect new process for accessing Communication Protocol lists.

Version 1.2.1

- Document Changelog added
- Unit minimum spacing requirements changed from 12 in. to 7 in. on pages 7 & 8

Version 1.2

- Updated minor formatting

Version 1.1

- Changed the UL 9540A certification from (Testing) to (Passed) in the Technical Specifications on page 2

Version 1.0

- First iteration of the completed Quick Start Guide



CONTACT US

support@eg4electronics.com

(903) 609-1988

www.eg4electronics.com