

# CONNECTION OVERVIEW AND PARALLELING GUIDE

---

## EG4<sup>®</sup> WALLMOUNT INDOOR 280Ah LITHIUM BATTERY



This document contains information to guide the end-user through the connections overview for both inverter and battery paralleling.





## 1. TECHNICAL SPECIFICATIONS

MODULE OPERATING PARAMETERS			
PARAMETER	BMS		RECOMMENDED SETTING
TOTAL ENERGY CAPACITY	14.3kWh @25C, 100% SOC		-
VOLTAGE	51.2V		
CAPACITY	280Ah		-
CHARGING VOLTAGE (BULK/ABSORB)	56.0V (+/-0.8V)		56.2V (+/-0.2V)
FLOAT	-		54V (+/-0.2V)
LOW DC CUTOFF	44.8V		47-45.6V (start high, lower as needed)
CHARGING CURRENT	200A (Max. continuous)		60A - 160A
DISCHARGING CURRENT	200A (Max. continuous)		160A
DISCHARGE RATE	10.24kW (Max. continuous)		-
ENVIRONMENTAL PARAMETERS			
CHARGING RANGE	32° to ≈113°F (0°C to ≈45°C)		
DISCHARGING RANGE	-4°F to ≈122°F (-20°C to ≈50°C)		
STORAGE RANGE	-4°F to ≈122°F (-20°C to ≈50°C)		
INGRESS PROTECTION	IP20		
CHARGING/ DISCHARGING PARAMETERS			
CHARGE	SPEC	DELAY	RECOVERY
CELL VOLTAGE PROTECTION	3.8V	1 sec	3.45V
MODULE VOLTAGE PROTECTION	60.0V	1 sec	55.2V
OVER CHARGING CURRENT 1	>205A	10 sec	-
OVER CHARGING CURRENT 2	>225A	3 sec	-
TEMPERATURE PROTECTION	<23°F or >158°F <-5°C or >70°C	1 sec	>32°F or <140°F >0°C or <60°C
DISCHARGE	SPEC	DELAY	RECOVERY
CELL VOLTAGE PROTECTION	2.3V	1 sec	3.1V
MODULE VOLTAGE PROTECTION	44.8V	1 sec	48V
OVER-CHARGING CURRENT 1	>205A	10 sec	60 sec
OVER-CHARGING CURRENT 2	>300A	3 sec	60 sec
SHORT CIRCUIT	>600A	<0.1 mS	-
TEMPERATURE PROTECTION	<-4°F or >167°F <-20°C or >75°C	1 sec	>14°F or <149°F >-10°C or <65°C
PCB TEMP PROTECTION	>230°F (>110°C)	1 sec	@ <176°F (<80°C)
GENERAL SPECIFICATIONS			
PARAMETER	SPEC		CONDITION
CELL BALANCE	120mA	Passive Balance	Cell Voltage Difference >40mV
TEMPERATURE ACCURACY	3%	Cycle Measurement	Measuring Range -40°F to ≈212°F (-40°C to ≈100°C)
VOLTAGE ACCURACY	0.5%	Cycle Measurement	For Cells & Module
CURRENT ACCURACY	3%	Cycle Measurement	Measuring Range -200A - 200A
SOC	5%	-	Integral Calculation
POWER CONSUMPTION	Sleep & Off Mode	<300uA	Storage/Transport/Standby
POWER CONSUMPTION	Operating Mode	<25mA	Charging/Discharging
COMMUNICATION PORTS	RS485/CAN		Can be customized
BATTERY HEATER SPECIFICATIONS			
PARAMETER	SPEC		CONDITION
VOLTAGE	56V		-
POWER CONSUMPTION	224W		-
INTERNAL BATTERY TEMPERATURE	≤32°F (0°C)≥41°F (5°C)		Heat On/Heat Off

## PHYSICAL SPECIFICATIONS

DIMENSIONS (H × W × D)	36.4 × 18.1 × 9.6 in. (925 × 460 × 245 mm)
WEIGHT	282 lbs. (128 kg)
DESIGN LIFE	>10 years
CYCLE LIFE	>8000 cycles @ 0.5C 80% DOD
LIFETIME PRODUCTION	82.6MWh*

*\*(51.2V×280Ah/1000×80%×8000 cycles/1000)90%=MWh*

## 2. SAFETY

### 2.1 SAFETY INSTRUCTIONS



**DANGER!**

**AVERTISSEMENT!**

***Hazardous Voltage Circuits!***

***Circuits à tension élevée!***

International safety regulations have been strictly observed in the design and testing of the inverter. Before beginning any work, carefully read all safety instructions, and always observe them when working on or with the inverter. The installation must follow all applicable national or local standards and regulations.

**Incorrect installation may cause:**

- Injury or death to the installer, operator or third party.
- Damage to the inverter or other attached equipment.

### 2.2 IMPORTANT SAFETY NOTIFICATIONS

There are various safety concerns that must be carefully observed before, during, and after the installation, as well as during future operation and maintenance. The following are important safety notifications for the installer and any end users of this product under normal operating conditions.

1. **Do not disassemble the battery.** Contact the distributor for any issues that need repair for more information and proper handling instructions. Incorrect servicing or re-assembly may result in a risk of electric shock or fire and void the warranty.
2. **Never short-circuit DC inputs.** Short-circuiting the battery may result in a risk of electric shock or fire and can lead to severe injury or death and/or permanent damage to the unit and/or any connected equipment.
3. **Use caution when working with metal tools on or around batteries and systems.** Risk of electrical arcs and/or short circuiting of equipment can lead to severe injury or death and equipment damage.
4. **Beware of high battery current.** Please ensure that the battery module breakers and/or on/off switches are in the “open” or “off” position before installing or working on the battery. Use a voltmeter to confirm there is no voltage present to avoid electric shock.
5. **Do not make any connections or disconnections to the system while the batteries are operating.** Damage to system components or risk of electrical shock may occur if working with energized batteries.
6. Make sure the battery and rack are properly grounded.
7. An installer should make sure to be well protected by reasonable and professional insulative equipment [e.g., personal protective equipment (PPE)].
8. Before installing, operating, or maintaining the system, it is important to inspect all existing wiring to ensure it meets the appropriate specifications and conditions for use.
9. Ensure that the battery and system component connections are secure and proper to prevent damage or injuries caused by improper installation.



## **WARNING: To reduce the risk of injury, read all instructions!**

All work on this product (system design, installation, operation, setting, configuration, and maintenance) must be carried out by qualified personnel. To reduce the risk of electric shock, do not perform any servicing other than those specified in the operating instructions unless qualified to do so.

1. Read all instructions before commencing installation. For electrical work, follow all local and national wiring standards, regulations, and these installation instructions. All wiring should be in accordance with the National Electrical Code (NEC), ANSI/NFPA 70.
2. The battery and system can connect with the utility grid only if the utility provider permits. Consult with the local AHJ before installing this product for any additional regulations and requirements for your area.
3. All warning labels and nameplates on this battery should be clearly visible and must not be removed or covered.
4. The installer should consider the safety of future users when choosing the battery's correct position and location as specified in this manual.
5. Please keep children away from touching or misusing the battery and relevant systems

### **DISCLAIMER**

EG4 reserves the right to make changes to the material herein at any time without notice.

Please refer to [www.eg4electronics.com](http://www.eg4electronics.com) for the most updated version of our manuals/spec sheets.

## 3. INSTALLING THE BATTERY

### 3.1 PRE-WIRE STEPS AND WIRING



#### IMPORTANT

*The battery can charge/discharge up to 200A before the BMS shuts off the pack. Ensure the inverter is configured to handle this high of a current and size all wires accordingly! Refer to an NEC approved ampacity chart or consult with the installer or a solar electrician for more information.*

The battery will come with 2 sets of 2/0 AWG power cables. Please refer to the inverter documentation that the battery will be connected to for torque specs and wire sizing needs for specific use cases.

### 3.2 MULTIMETER TESTING AND WIRING



#### **DANGER! No connections should be made until proper polarity of cables has been confirmed!**

Follow the steps outlined below to both test the inputs and wire the battery pack to the 18kPV and the 6000XP, specifically. If using non-EG4 inverters, please refer to the appropriate manufacturer user manual and/or spec sheet.

1. Ensure all circuit breakers are open (off). Using a multimeter, check for voltage at all available disconnects and lines. Once no voltage is confirmed, proceed to the next step.
2. Connect the included sets of 2/0 AWG (70mm<sup>2</sup>) with outdoor rated connectors to the battery's positive and negative terminals. The connectors will "click" when seated properly.
3. If applicable, route the battery power cables through the conduit box to the inverter **before making any connections!**
4. Ensure proper polarity of cables. Once confirmed, proceed to the next step.
5. Install the positive battery cable(s) to the inverter's positive battery terminals following proper torque values.
6. Install the negative battery cable(s) to the inverter's negative battery terminals following proper torque values.



**NOTE:** If installing the battery pack with the optional conduit box, secure the conduit fittings to the enclosure using the counter nuts after step 2.

## 4. EXAMPLE CONNECTION CONFIGURATIONS

The diagrams below show a few different examples for paralleling the batteries. These diagrams are for reference only!

### 4.1 BATTERY CABLE CONNECTIONS

The following battery cable connection diagrams are examples using the internal busbars to parallel the batteries together and attach the inverter(s) to the batteries. When relying on the internal busbars, up to 3 batteries are supported in parallel when connected to a single inverter, 4 batteries in parallel when connected to 2 inverters, or up to 5 batteries in parallel when connected to 3 inverters.

Systems with more batteries than these configurations require the use of an external fused positive busbar and an unfused negative busbar rated at a minimum of 200A per battery. Each fuse should be a maximum of 250A. Alternatively, larger systems could rely on the 18kPV's ability to draw from different battery packs while still paralleling inverters rather than utilizing external busbars.

The maximum recommended number of paralleled 18kPV inverters is 6. If this approach is used, we recommend a ratio of 2 batteries per pack controlled by each 18kPV inverter. Separating packs is only recommended if each pack's average SOC is monitored over time and does not diverge by more than 10%. Common busbars are superior to separating battery packs but it may be difficult to source fused positive busbars rated to greater than 1800 Amps. This translates into separating packs larger than 9 batteries. Refer to NEC code and the local AHJ for exact requirements.



**NOTE:** In the following diagrams, units are spaced 7 in. apart. Local regulations may require a larger minimum battery spacing. Check with the local AHJ for these requirements. If longer parallel cables than are available in the optional paralleling kit are necessary, please check with the distributor for availability.

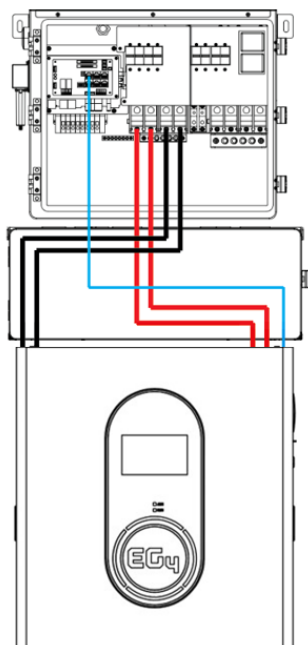

**Note:** To comply with the UL9540 listing for this integrated battery, conduit box, and inverter system, the batteries must be wired as shown using the supplied inverter to battery cables. An additional paralleling kit is required for each additional paralleled battery (sold separately).



**Caution:** To minimize voltage drop in the wire, the battery cables should maintain optimum length. The 53.1 in. cables from the "parallel kit" are sufficient to daisy chain the batteries.

Figure 1 – (1) 18kPV with (1) WallMount



## 4.2 ADDITIONAL CONFIGURATIONS

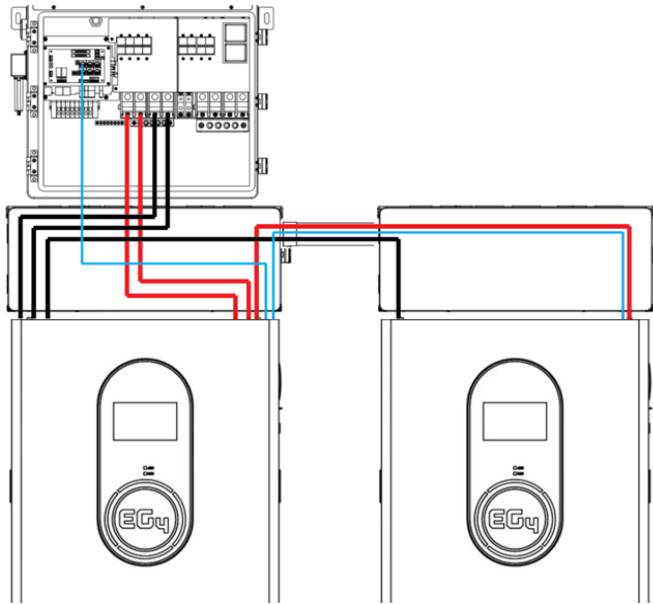

Figure 2 – (1) 18kPV with (2) WallMount



**Note:** Some configurations require additional wiring/connectors to achieve the example layouts. Inverter to inverter paralleling cables are not shown in the following diagrams. Other configurations can be achieved by using external busbars. Please seek the guidance of an electrician or qualified personnel for optional system layout.

**Pro Tip:** One EG4 18kPV and a minimum of 2 WallMount units is the recommended configuration to maximize the system's functionality.

### Color Code

	Parallel/Comms
	Positive
	Negative

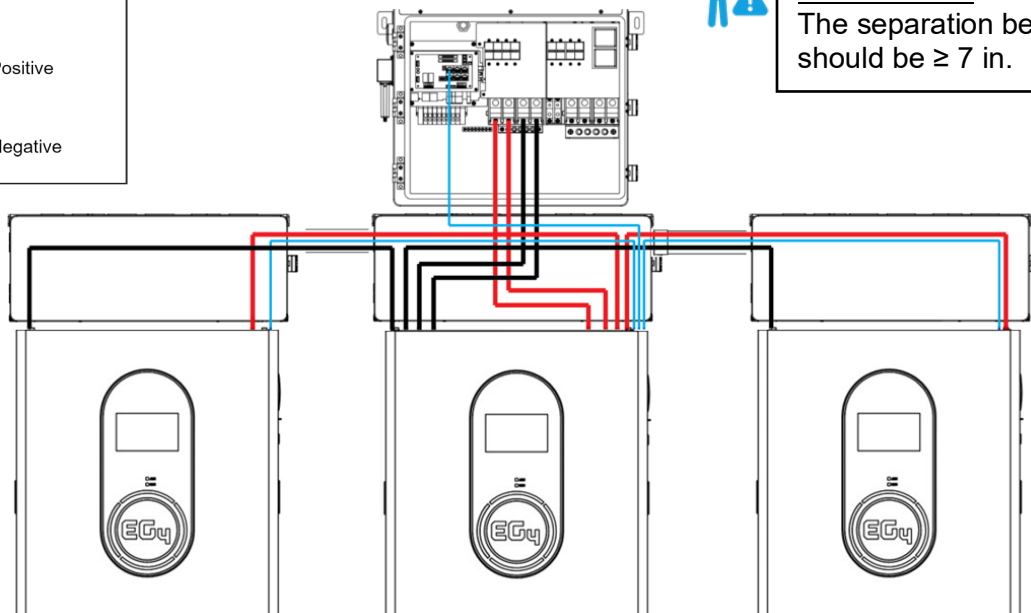

Figure 3 – (1) 18kPV with (3) WallMount



**Reminder!**  
The separation between batteries should be  $\geq 7$  in.

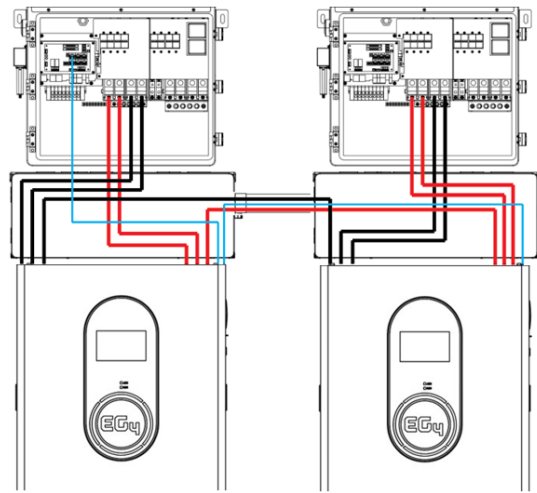

Figure 4 – (2) 18kPV with (2) WallMount

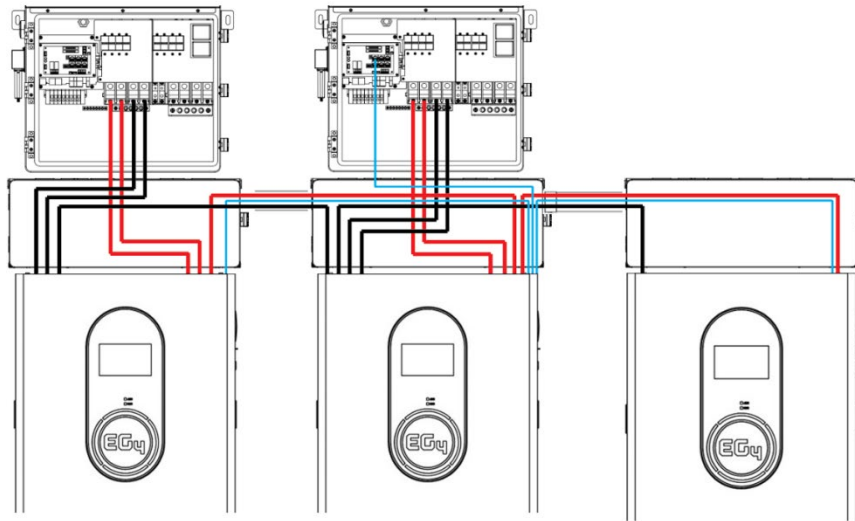

Figure 5 – (2) 18kPV with (3) WallMount

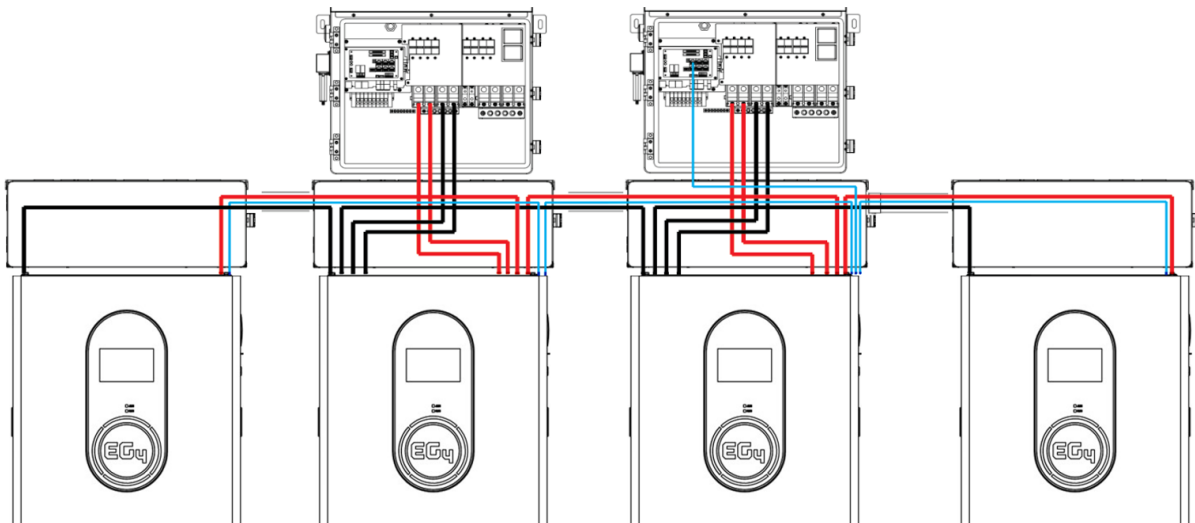
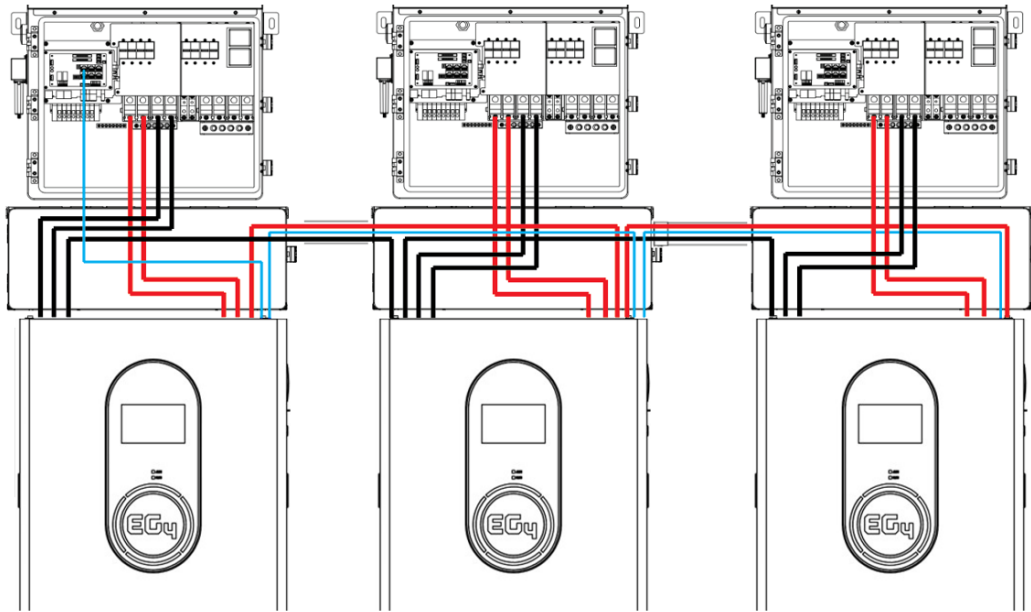
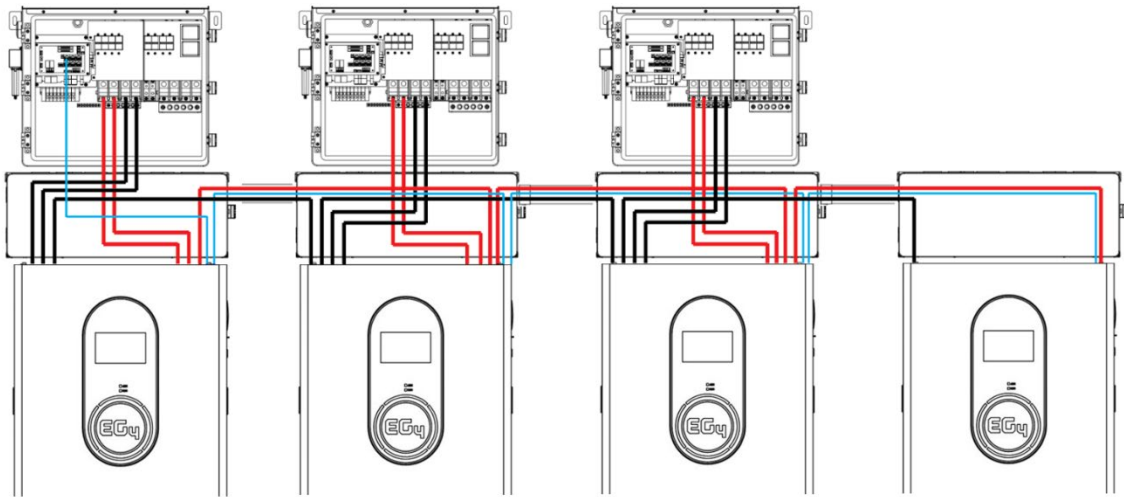

Figure 6 – (2) 18kPV with (4) WallMount



**Figure 7 - (3) 18kPV with (3) WallMount**



**Figure 8 - (3) 18kPV with (4) WallMount**

## 4.3 MULTIPLE BATTERY PARALLEL INSTALL



**WARNING:** Make sure to install the communication cables into their respective ports! Improper installation may lead to component damage! EG4 recommends double checking all points of connection before introducing power to the system to mitigate any potential issues.

When paralleling multiple WallMount batteries, a paralleling kit must be purchased through the distributor.

Follow the steps outlined below to ensure proper installation of multiple batteries in parallel.

1. Ensure all circuit breakers are open (off). Using a multimeter, check for voltage at all available disconnects and lines. Once no voltage is confirmed, proceed to the next step.
2. Set the DIP switch address on the master battery to address 1, and all other batteries in parallel to differing addresses going in ascending order. (See image) →
3. Reset the battery BMS via the power button to register the address change.
4. Set up communication between the batteries via the “Battery-Comm” ports by using a CAT 5, 5e, or 6 cable.

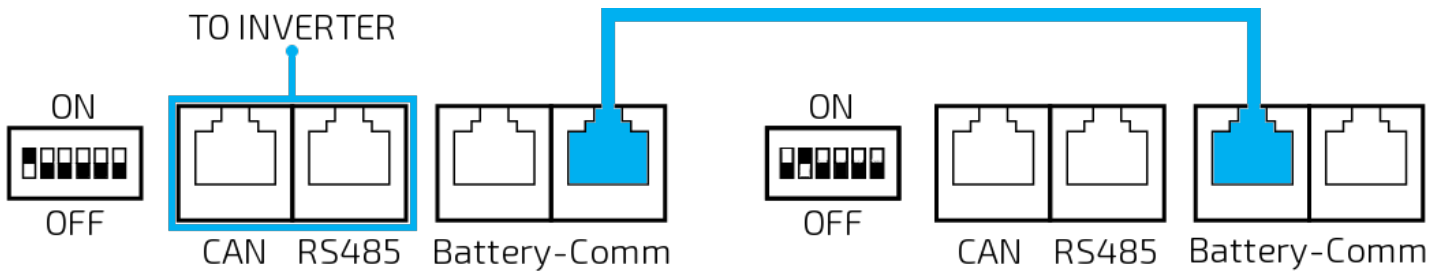
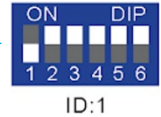

5. The battery set to address 1 will connect directly to the inverter BMS communication port via CAT 5, 5e or CAT 6 cable (when using non-EG4 inverters, check the manufacturer’s documentation for specifics).
6. Install the battery paralleling cables (included in the optional paralleling kit) between the batteries ensuring the connectors are seated properly.

The image to the left shows a representation of the dip switch. The white represents the switches and how they should be set. →

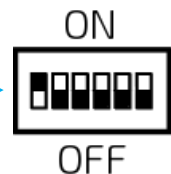

For additional examples of paralleling batteries, reference the next page.

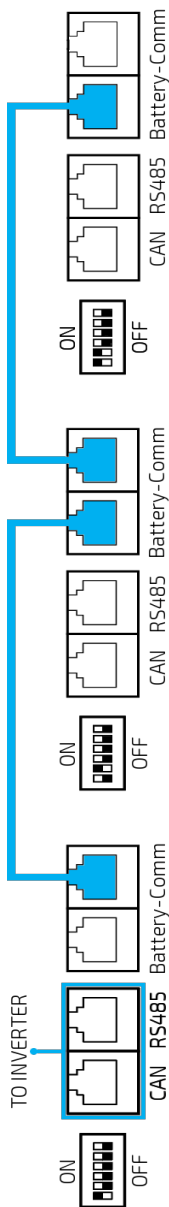

**Figure 9 – (3) WallMounts in parallel**

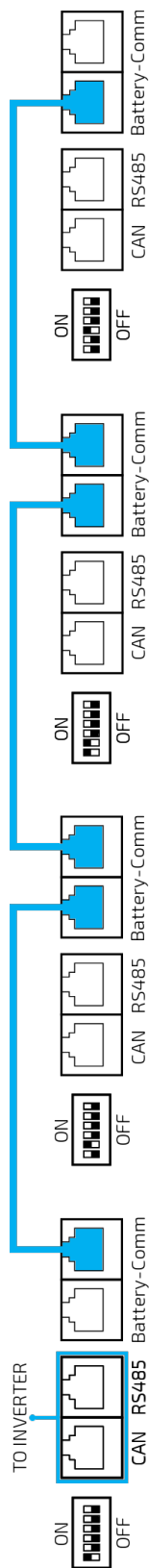

**Figure 10 – (4) WallMounts in parallel**

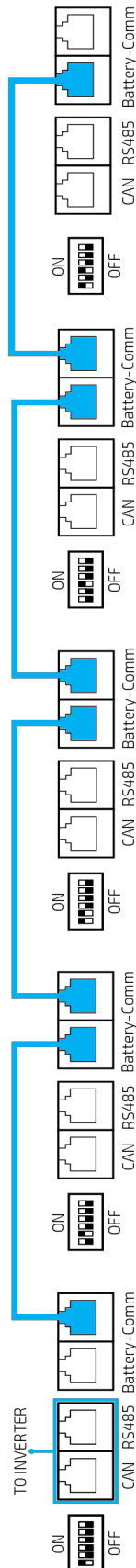

**Figure 11 – (5) WallMounts in parallel**

## 5. EMERGENCY STOP (RSD, ESS DISCONNECT)



**WARNING:** Make sure to install the communication cables into their respective ports!

Improper installation may lead to component damage!

EG4 recommends double checking all points of connection before introducing power to the system to mitigate any potential issues.

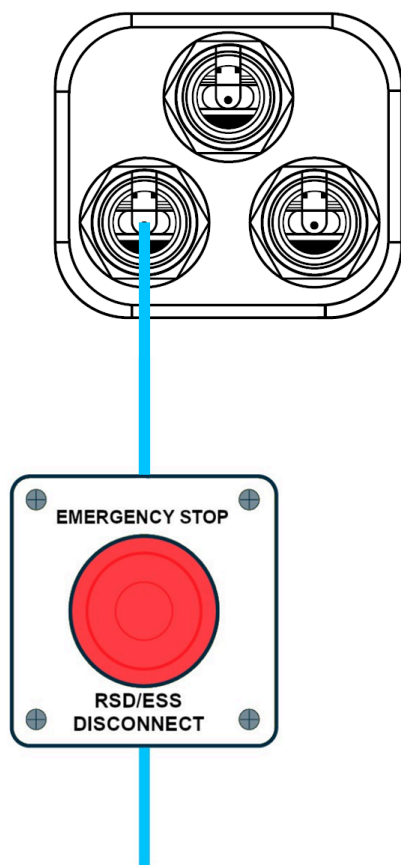

To inverter, RSD Initiator, or ESS Disconnect  
(inverter recommended if compatible with inverter's RSD system)  
Normally Open (NO) or Normally Closed (NC) contacts depending  
on the inverter.

**Figure 12 – Emergency Stop**

The optional ESS disconnect can be used to shut down all batteries and inverters (if equipped) with the push of a button.

When paralleling multiple batteries, the ESS disconnect only needs to have connections made with the master battery.

This integrated safety feature ties directly into the battery communication system via an open Battery-Com port using a standard Cat-5/6 ethernet cable.

Pins 3 & 6 are used to communicate the emergency stop information to the batteries once the stop button is pressed.

If the inverter is equipped with rapid shut down (RSD) capabilities, the emergency stop feature can be used to initiate this function. Check with the local AHJ and NEC code for compliance.

## 6. BATTERY COMMUNICATIONS

Each EG4 battery is designed with the end-user in mind, displaying as much information as possible in a compact and simple manner. EG4 Electronics includes the option of connecting the battery to PC software (BMS Tools) to monitor the module status. This allows the user to see and understand exactly what the battery is doing as well as troubleshoot if problems arise.



**NOTE:** The master battery will communicate directly with the system via the RS485/CAN port.



**WARNING:** Make sure to install the communication cables into their respective ports!

*Improper installation may lead to component damage!*

*EG4 recommends double checking all points of connection before introducing power to the system to mitigate any potential issues.*

### 6.1 DIP SWITCH ID TABLE

EG4 batteries interface with an inverter by designating a “Master” battery (DIP switch ID No. 1). The available ID codes range from 1–64. The battery will connect directly to the inverter via an RS485 battery communications cable or a standard CAT 5, 5e, or 6 cable. For closed loop communications using CAN bus protocols with non-EG4 inverters, please check the manufacturer’s documentation for more information.



**REMINDER:** If paralleling multiple batteries, all DIP switch settings **must** be different from each other. This allows all equipment to see each battery in the bank separately. For best practice, place IDs in sequence starting with ID:1 as the master battery.

ID:1	ID:2	ID:3	ID:4	ID:5	ID:6	ID:7	ID:8
ID:9	ID:10	ID:11	ID:12	ID:13	ID:14	ID:15	ID:16
ID:17	ID:18	ID:19	ID:20	ID:21	ID:22	ID:23	ID:24
ID:25	ID:26	ID:27	ID:28	ID:29	ID:30	ID:31	ID:32
ID:33	ID:34	ID:35	ID:36	ID:37	ID:38	ID:39	ID:40
ID:41	ID:42	ID:43	ID:44	ID:45	ID:46	ID:47	ID:48
ID:49	ID:50	ID:51	ID:52	ID:53	ID:54	ID:55	ID:56
ID:57	ID:58	ID:59	ID:60	ID:61	ID:62	ID:63	ID:64

Figure 13 – Dipswitch ID Table

## 7. LCD SCREEN

Each module has a built-in HD LCD touch screen used to display important information about the battery cells including voltage, current, temperature, SOC, and other values.

### 7.1 WAKING UP THE LCD SCREEN

Press anywhere on the screen to wake up when the power is on, and the information will be shown on the display. (See image below)

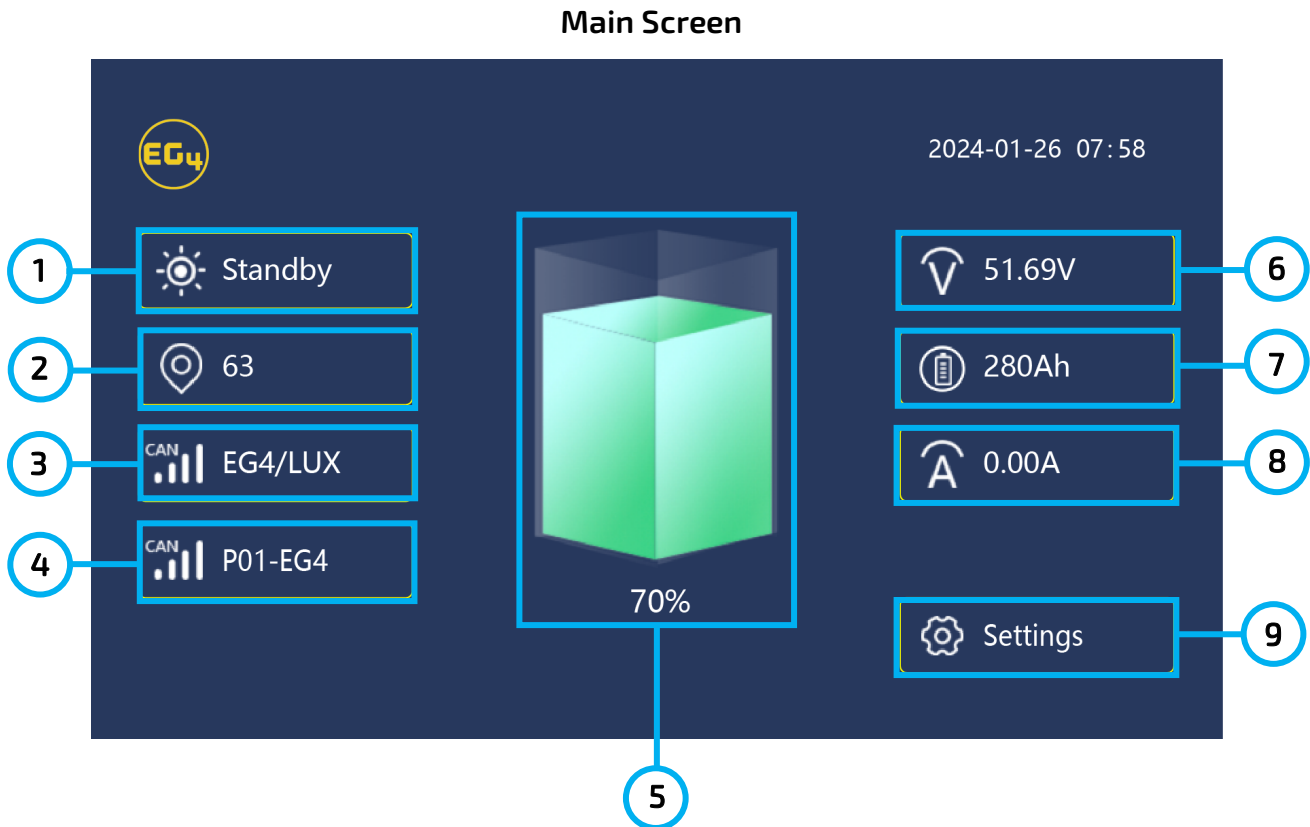

NUMBER	DESCRIPTION
1	Status
2	Dip Switch ID Location
3	CAN Protocol
4	RS485 Protocol
5	State of Charge
6	Voltage
7	Battery Amp Hours
8	Amps
9	Settings



## 7.2 SETTINGS SCREEN

This screen will allow the user to access the different settings and protocols of the battery. (See image below.)

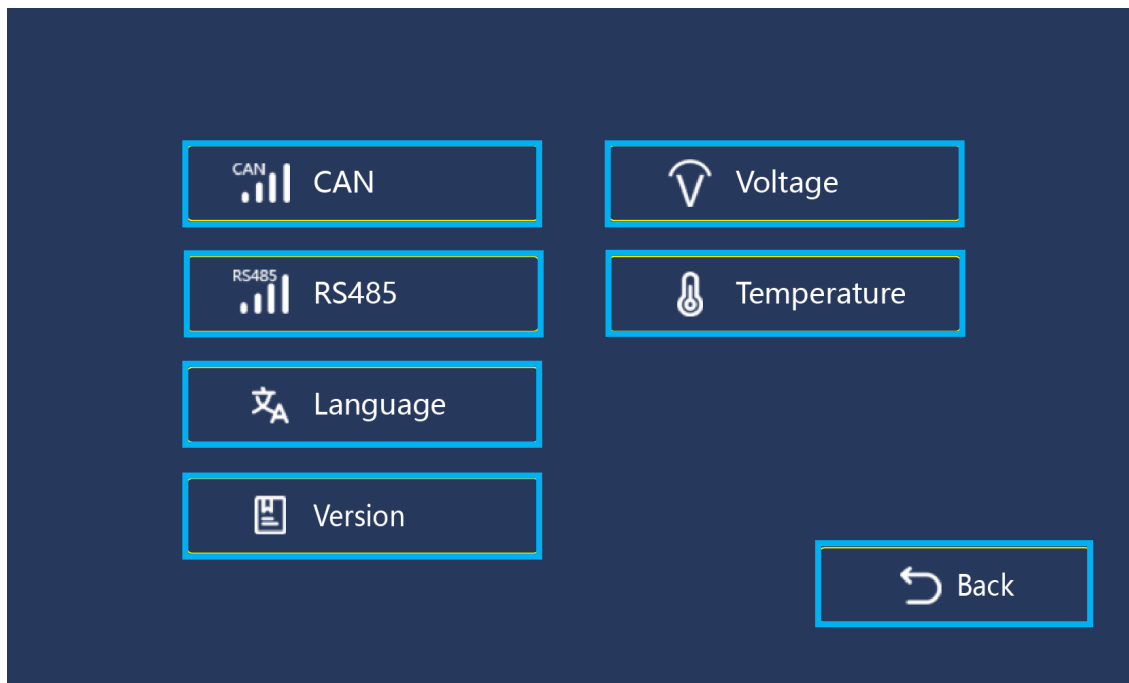

## 7.3 SETTINGS DESCRIPTION

- **CAN Protocol** – Allows the user to configure the protocol after entering the password, “123456”. (See images below)

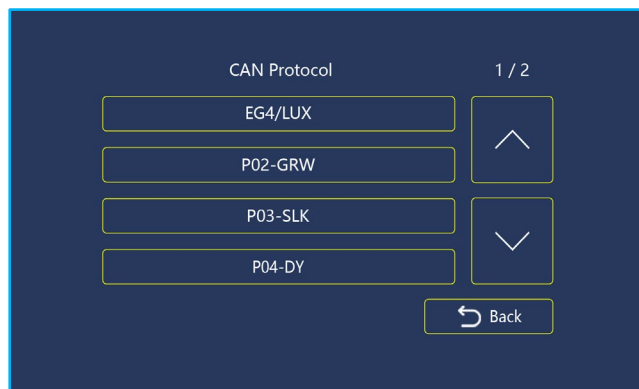
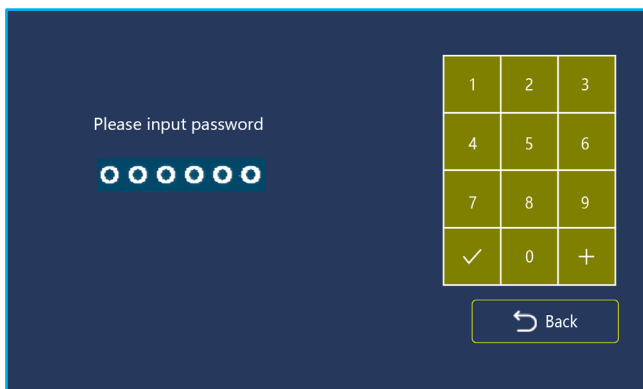

**NOTE:** Both the CAN Protocol and RS485 Protocol menus are password protected. The password for each is “123456”.

PROTOCOL #	MANUFACTURER
P01-EG4/LUX	EG4/LUX
P02-GRW	Growatt
P03-SLK	Sol-Ark
P04-DY	Deye
P05-MGR	Megarevo
P06-VCT	Victron
P07-LUX	Luxpower
P08-SMA	SMA

- **RS485 Protocol** – Allows the user to configure the protocol after entering the password, “123456”. (See images below)

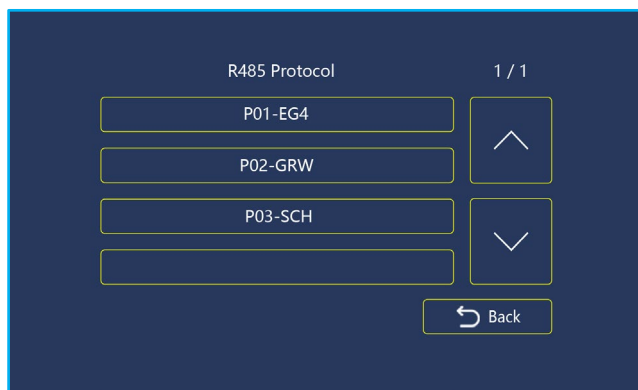
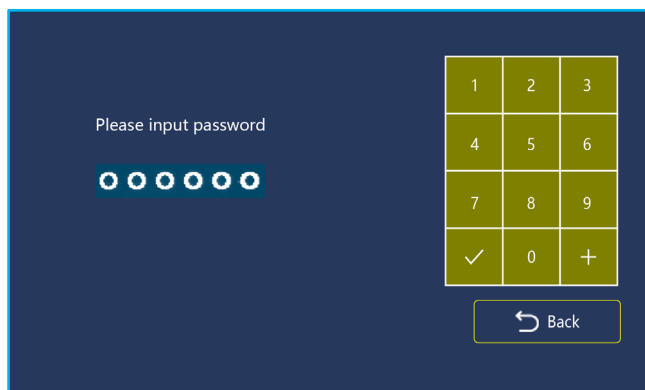

**NOTE:** Both the CAN Protocol and RS485 Protocol menus are password protected. The password for each is “123456”.

PROTOCOL #	MANUFACTURER
P01-EG4	EG4
P02-GRW	Growatt
P03-SCH	Schneider

- **Language** – Allows the user to change the language between English and Spanish. (See image below)

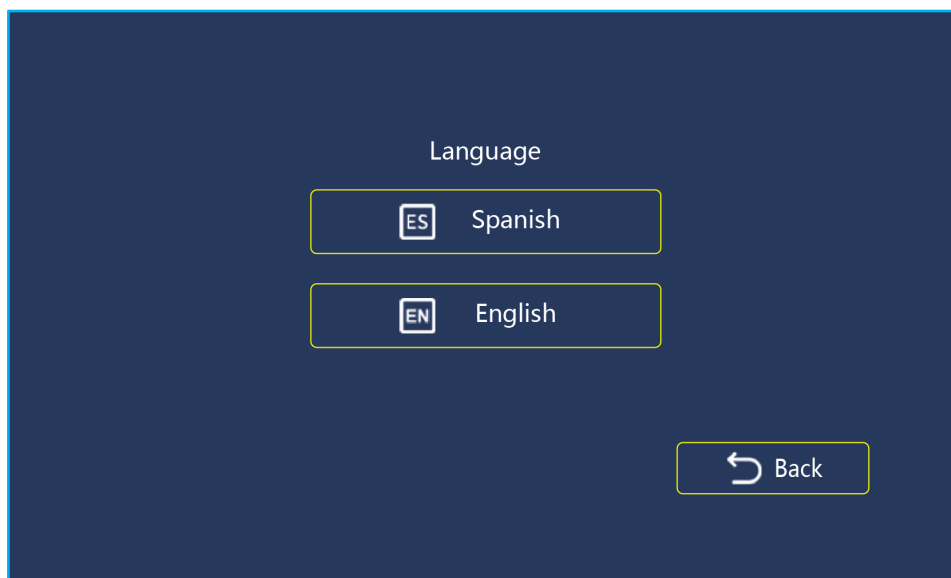

**Version** – Allows the user to see what version of firmware is installed.  
(See image below.)

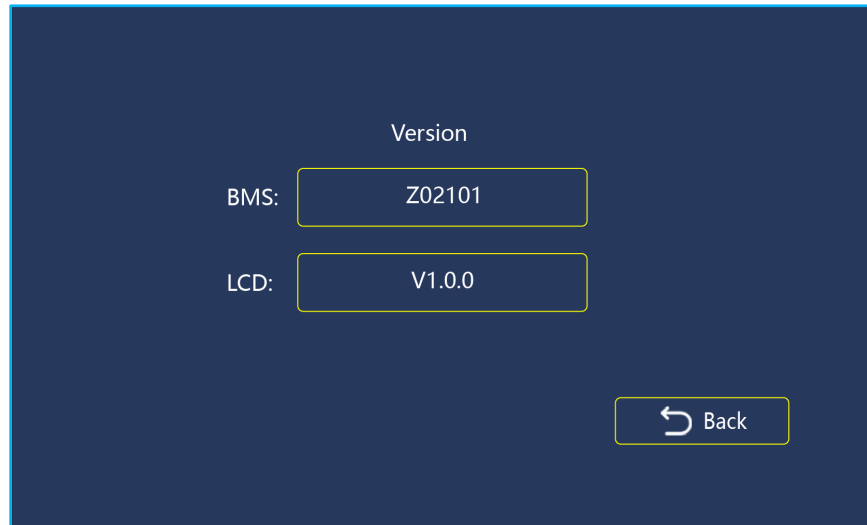

**Voltage** – Allows the user to monitor the voltage of each cell individually.  
(See image below.)

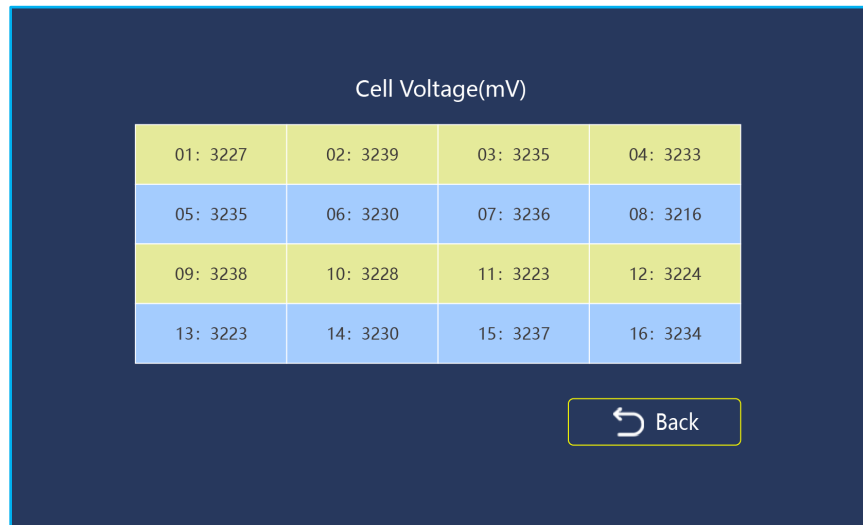

**Temperature** – Allows the user to monitor the temperature readings from all four sensors simultaneously. (See image below)

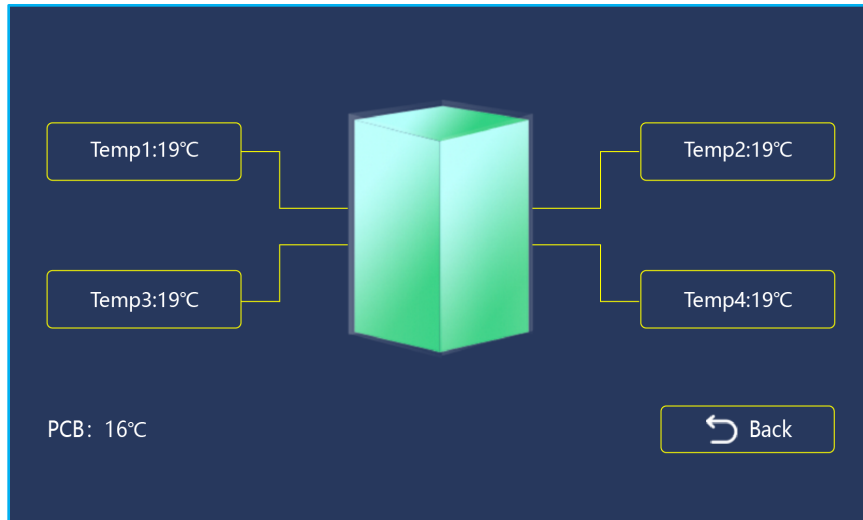

## C H A N G E L O G

### **Version 1.1.2**

- Added 2 line items in the Technical Specifications Table: Total Energy Capacity & Discharge Rate
- Minor formatting changes

### **Version 1.1.1**

- Added changelog
- Changed the minimum required spacing between units from 12 in. to 7 in. on pages 6 and 7.

### **Version 1.1.0**

- Corrected minor formatting issues

### **Version 1.0.0**

- First iteration of the completed White sheet





## CONTACT US

[support@eg4electronics.com](mailto:support@eg4electronics.com)

(903) 609-1988

[www.eg4electronics.com](http://www.eg4electronics.com)