



*Westalee*  
DESIGN

by *Sew Steady*<sup>®</sup>

**Quilting Templates and  
Rulers**

**Quilting  
Templates and Rulers**

**to use with  
Domestic Machines when fitted  
with the  
Westalee Ruler Foot**

**and  
Longarm, Midarm  
and sit down machines**

**Catalogue 2 ver1**

Precision Patchwork and Quilting Tools  
Designed and in Australia made in the USA

*Westalee*  
DESIGN

by *Sew Steady*®

Patchwork and Quilting Tools  
designed by INNOVATION not imitation

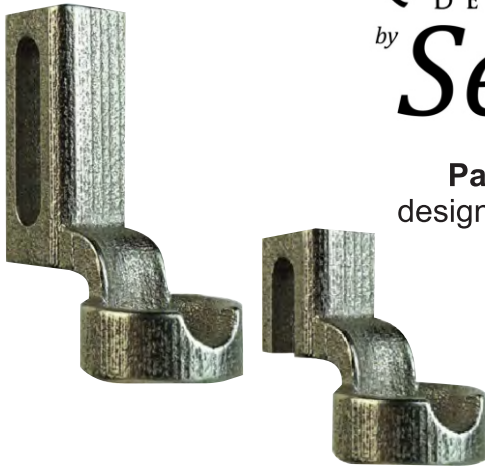

***If you have ever admired the beautiful ruler work on show quilts and wish that you could use the same rulers and templates on your domestic sewing machine.***

Now you can, with the Westalee Ruler Foot and the Westalee Quilting Templates and Rulers.

## Now you can use Templates safely on Domestic Sewing machines

### A range of Ruler Feet to suit most machines



The gap between the Long Arm Machine and the Domestic Machine has been wide for some time now and we know that not all quilter's will get to own a long arm quilting machine or large sit down machine for various reasons, including cost of machine and room required to fit them.

A lot of quilter's are intimidated by free motion and want to do more than stippling.

Over the past few years we have been asked many, many times if our templates for quilting can be used on a domestic machine. Many quilter's have purchased domestic machines and some in frames and they want to be able to use templates and rulers. The problem has been the lack of a half inch ruler foot that can be used with templates on domestic machines.

We have 4 Ruler Feet with a true 1/2" foot, stitching a 1/4" from the needle to the template, with nothing to impede your vision next to or behind the Ruler Foot.

Our Ruler Foot will fit most modern domestic sewing machines and many older models.

\$75.00  
WRF



# Sampler Template Set 1

for  
Quilting on Domestic Sewing Machines  
using the Westalee Ruler Foot

Templates for Westalee Ruler Foot

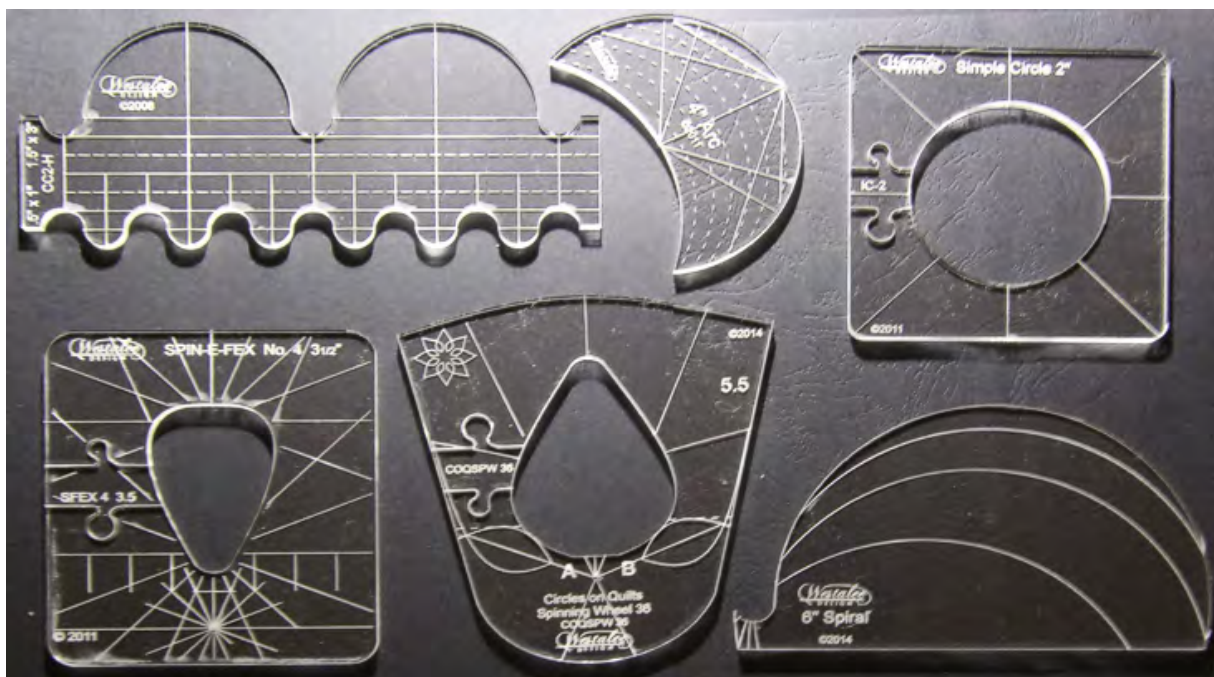

A set of 6 templates to get you started with Ruler work on your domestic sewing machine

- 1 x 6" Spiral
- 1 x Spin-e-fex No. 4
- 1 x Circles on Quilts Spinning Wheel No. 36
- 1 x 4" Arc
- 1 x Clamshell
- Bonus 2" Inside Circle
- 2 x Pins and Locks

WQTSS- 6     \$65.00

Available for Domestic Sewing Machines and Longarm Quilting Machines

## FEATHER TEMPLATE

Quilting feathers can be difficult, but with the Feather Templates you can quilt straight feathers -feathers on a wavy spine - feathered plumes



Our feather Templates are sold separately or in a set of 4  
FS4 Set of 4 \$60.00

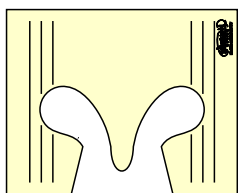

F2  
\$20.00

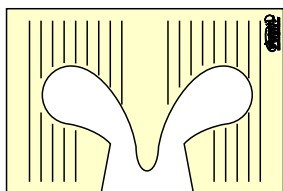
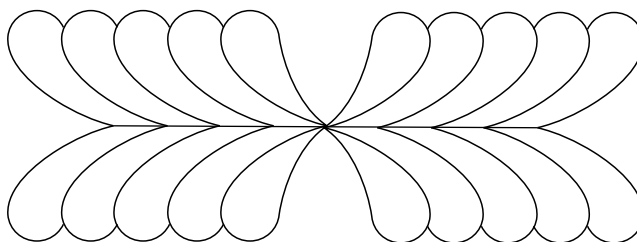

F3  
\$20.00

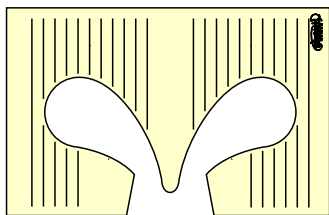
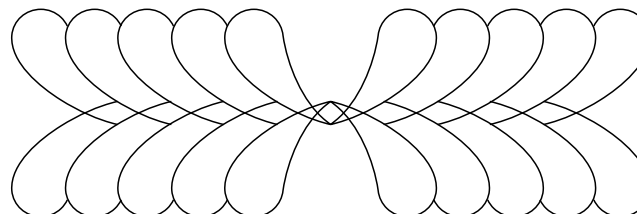

F4  
\$20.00

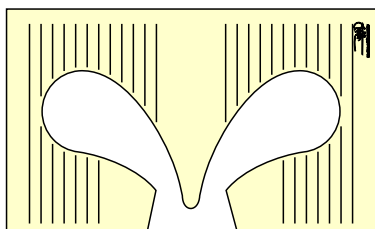
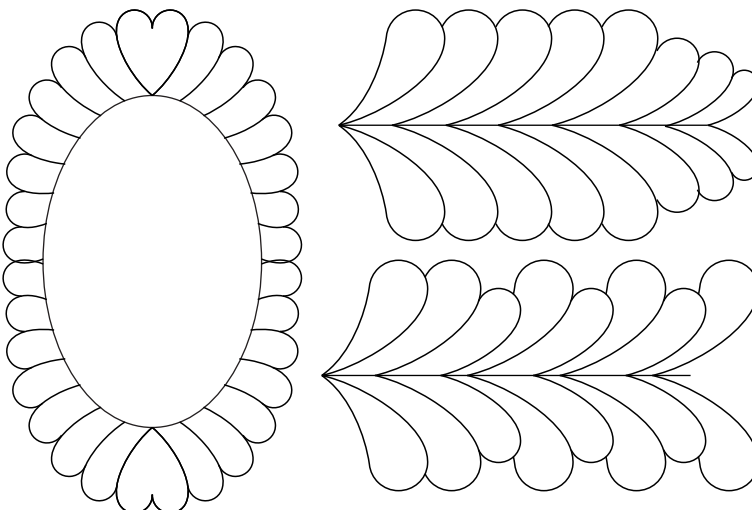

F5  
\$20.00

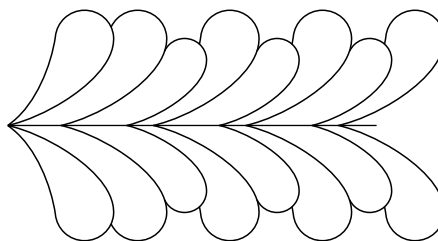

Please note:- an instructional video for the Feather Templates is free to view on YouTube

## SIMPLE CIRCLES

It is funny how 1 problem leads to another, but if you work at it hard enough the solution to both can lead to so much more,

In 2008 when we began making templates for Longarm quilting, it quickly became obvious that quilters had difficulty stitching around the outside of circles and other shapes. I have always believed that it is much easier to draw inside a shape than around the outer edge. So we designed our templates to be stitched around the inside.

This left another problem, longarm machines could not enter the inside of the template.

The answer to this problem was the invention of the unique **Westalee Design Key System**, a key that when removed allows the ruler foot to be placed inside the template, when the key is replaced the opening is closed and the quilting line can be sewn without any unsightly flat spots.

The invention of our unique **Westalee Design Key System** in 2008 made it possible to stitch other difficult designs such as Ovals, Diamonds and Hexagons.

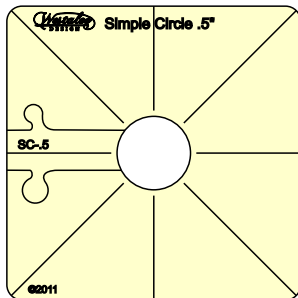

SC.5 \$16.00

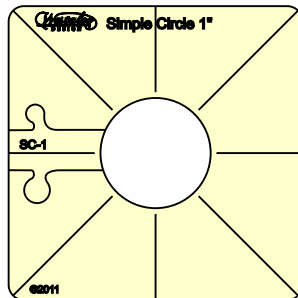

SC1 \$16.00

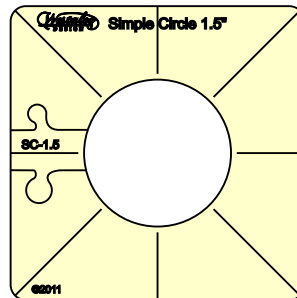

SC1.5 \$16.00

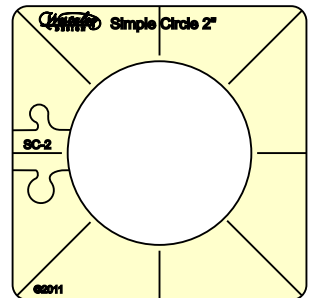

SC2 \$16.00

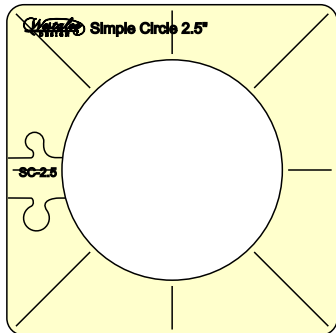

SC2.5 \$16.00

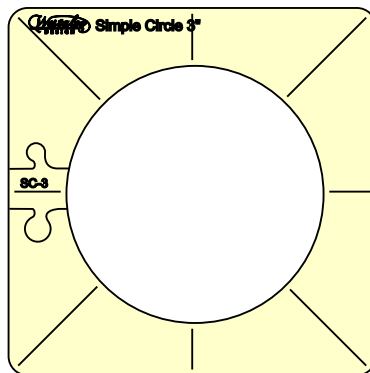

SC3 \$20.00

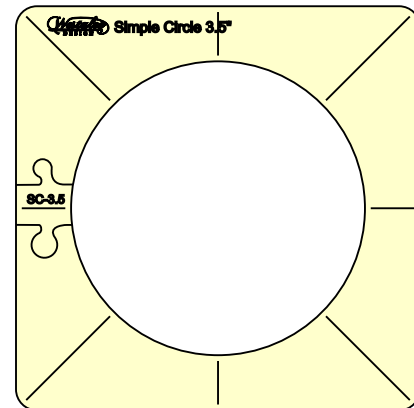

SC3.5 \$20.00

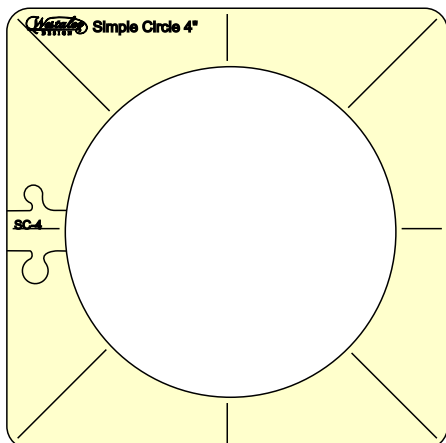

Sc4 \$25.00

Set of 4 SC.5 - Sc1 - SC1.5 - SC2 \$50.00

Set of 4 SC2.5 - SC3 - S3.5 - SC4 \$60.00

**SIMPLE OVALS AND HEXAGONS**

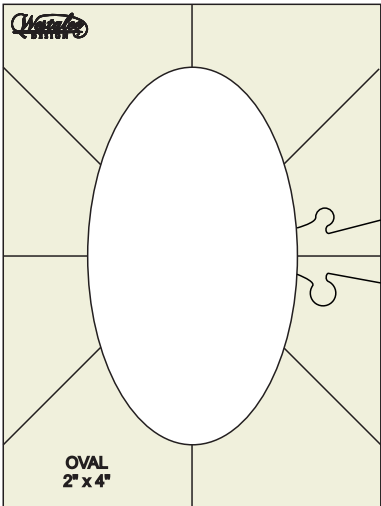

SO-2x4  
\$25.00  
Set of 3 \$50.00

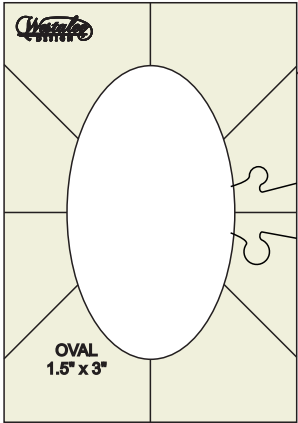

SO-1-5x3  
\$20.00

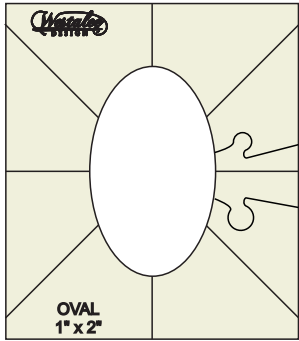

SO-1x2  
\$16.00

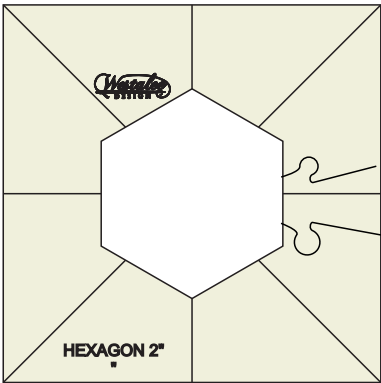

SO-2x4  
\$20.00  
Set of 3 \$50.00

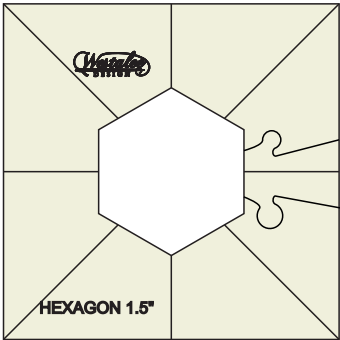

SO-1-5x3  
\$20.00

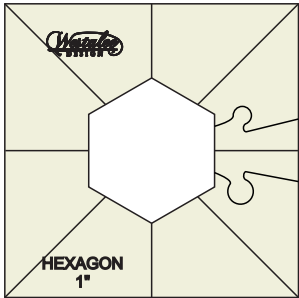

SO-1x2  
\$16.00

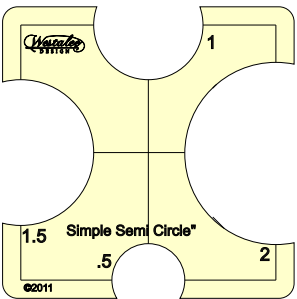

**SIMPLE SEMI CIRCLES**  
\$16.00

# BETWEEN THE LINES

Great little tools to enable you to stitch beautiful circles to create fill between the lines.

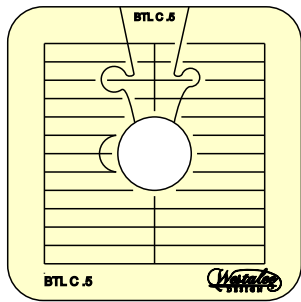

BTL.C.5 \$16.00

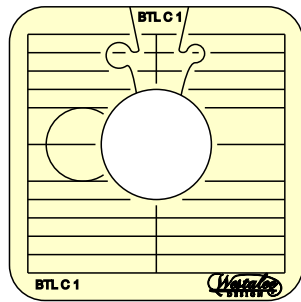

BTL \$16.00

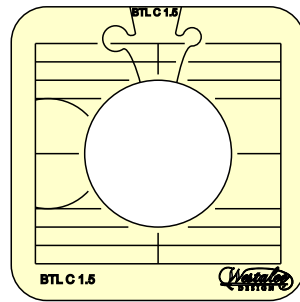

BTL \$16.00

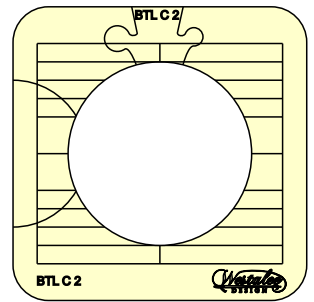

BTL \$16.00

**Set of 4 \$50.00**

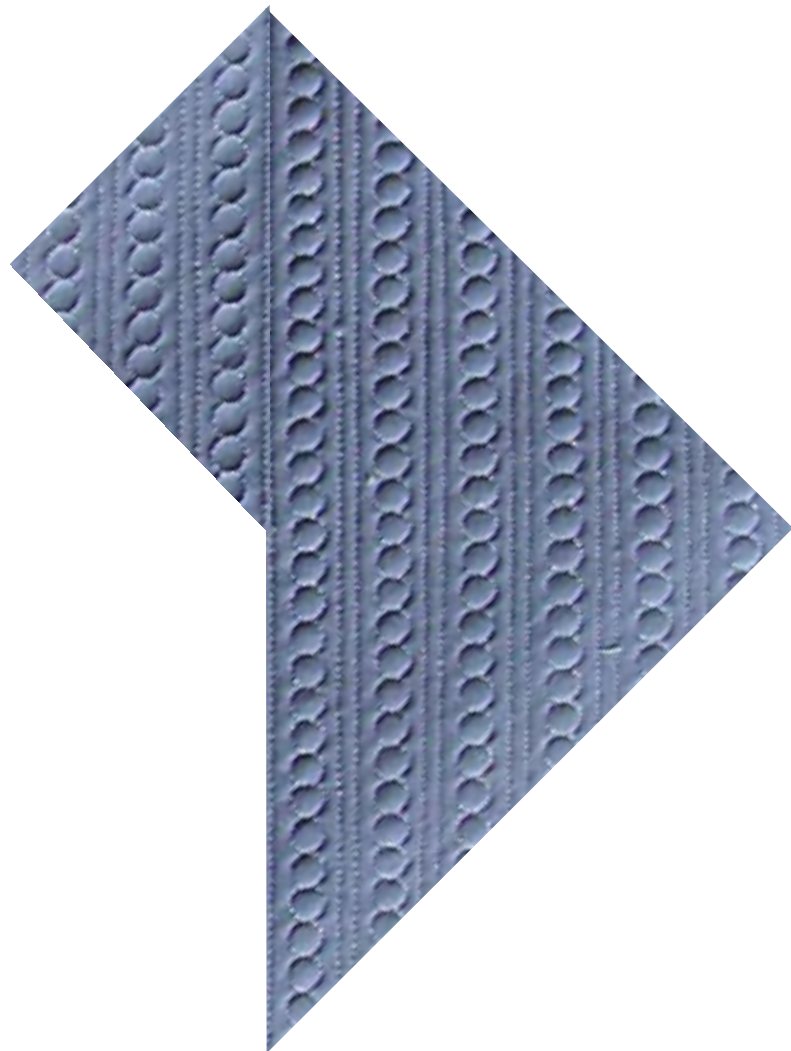



## Add a Handle to any ruler or template

Make sure that your ruler or template is clean and dry.  
Remove backing paper and press  
in place.

Pack of 2 large, 2 medium and 2 small  
\$12.00

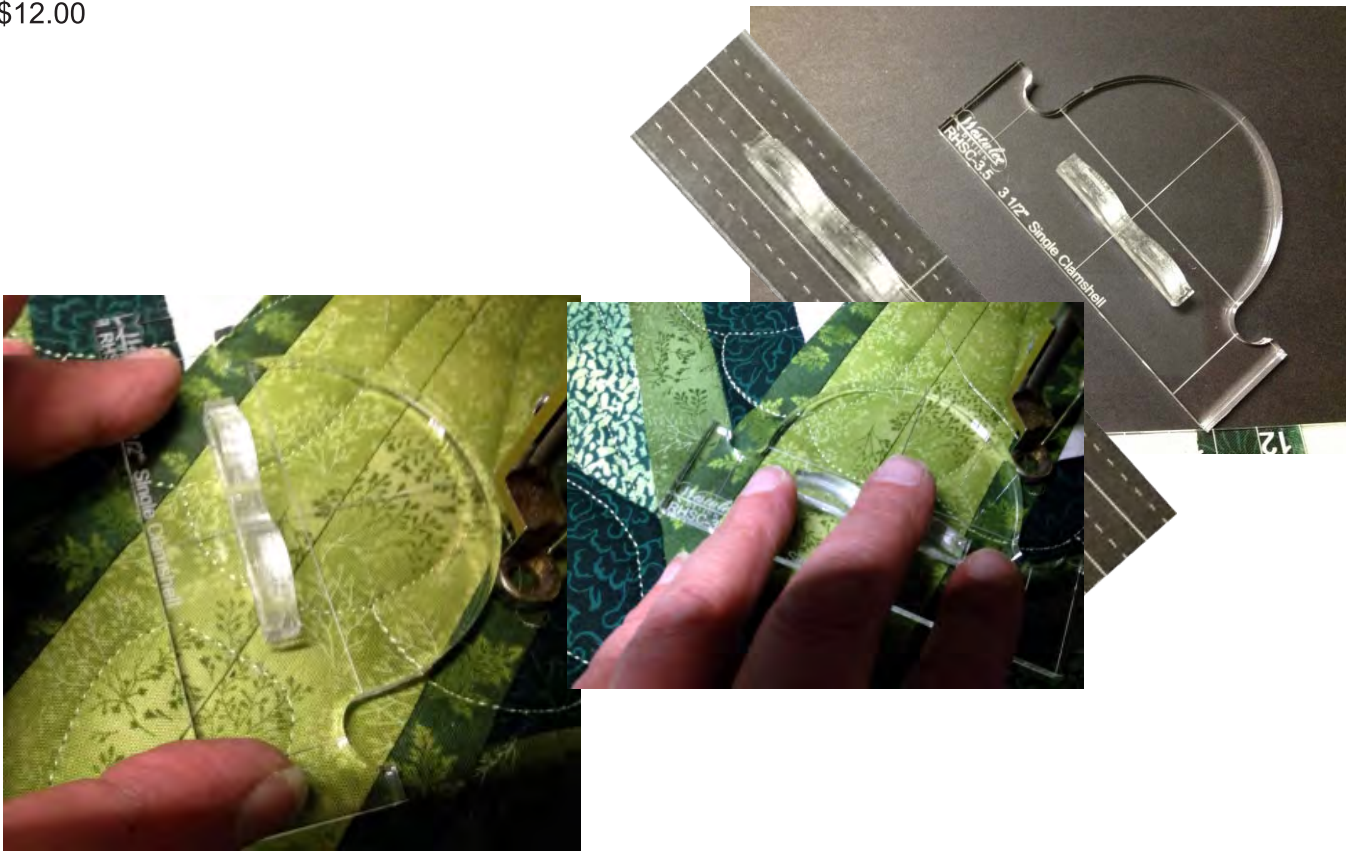

## Ruler Rack

Holds 14 rulers or templates

\$36.00

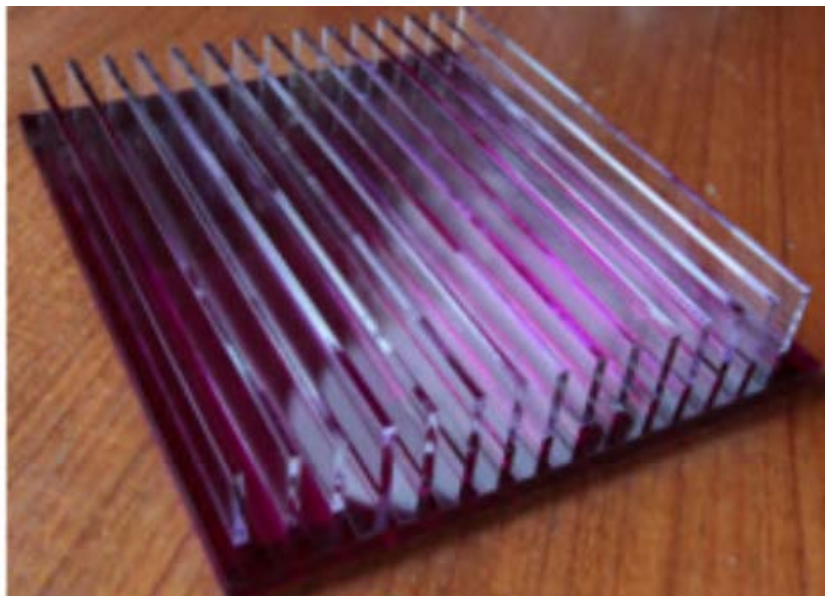

Whether quilting on a domestic machine or a longarm machine I like to mark reference lines on my quilts.

Reference lines give me a much better result. If I am using rotating templates, reference lines will give much more accurate spacing.

On a domestic machine the quilt is not taught as on a longarm machine and there is movement of the quilt sandwich which can make it difficult to use the rotating lines on the templates. So I mark in the reference lines.

I like using our **Cross Hair Ruler** to locate the centre and mark 4, 8, 16 and 32 lines if required.

The Little Rotation Bobs are for marking evenly spaced rotations when using tools such as the Spinning Waves, these are great for use when quilting on a domestic sewing machine.

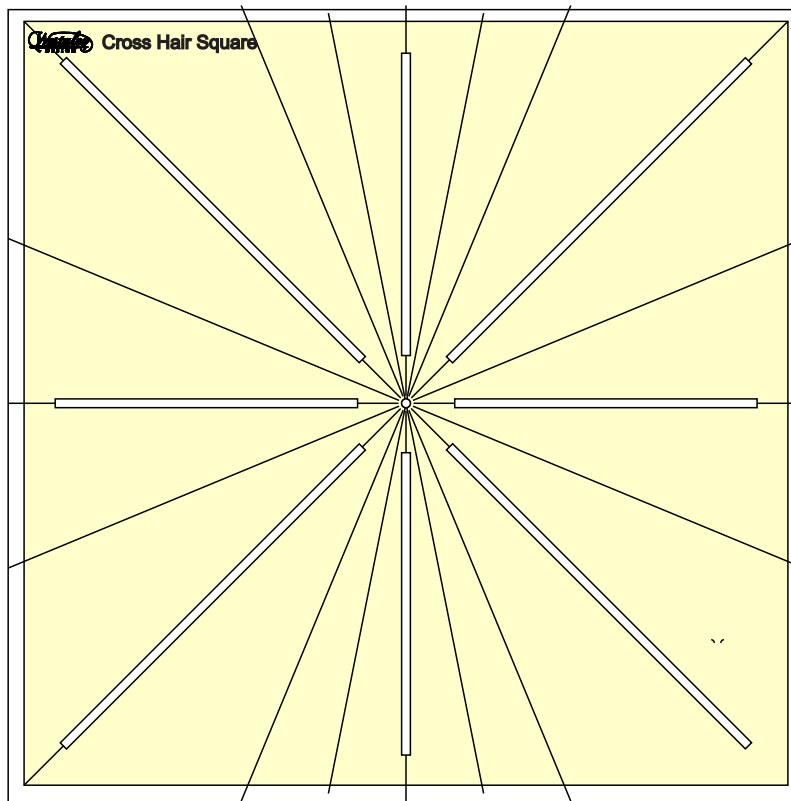

Cross Hair Square 12.5"

CHS12.5  
\$35.00

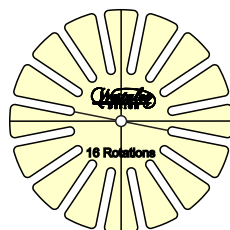
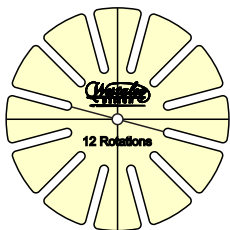

Little Rotation Bobs  
12 and 16 Rotations

LRB  
\$14.00

### Longarm Adjustable Storage Tray

For all those things you want to reach quickly, (or find) when your are quilting, we have manufactured a practical sized Utility Tray.

Adjustable to fit even the largest Quilt Table. Sitting over the rollers and next to your work. Made from 6mm Acrylic a great way to keep your workspace where you want it, nearby.

Utility Tray - \$98.00



CONTINUOUS ROPE AND ECHO

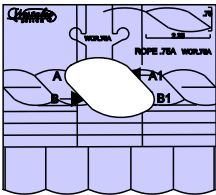

WCR .75A

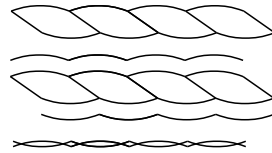

.75" \$22.00

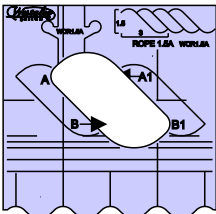

WCR 1.5A

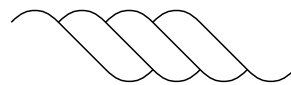

1.5" \$22.00

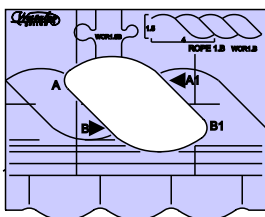

WCR 1.5B

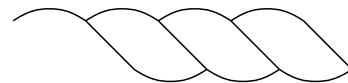

1.5" \$24.00

CONTINUOUS ROPE AND ECHO

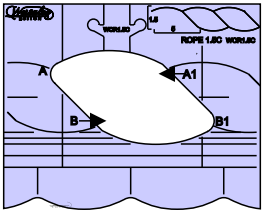

WCR 1.5C 1.5" \$24.00

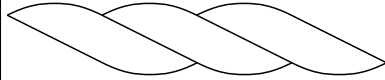
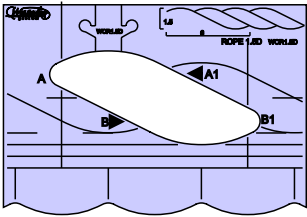

WCR 1.5D 1.5" \$28.00

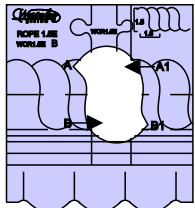

WCR 1.5E 1.5" \$22.00

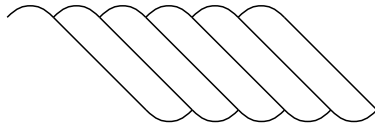
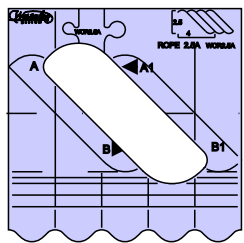

WCR 2.5A 2.5" \$24.00

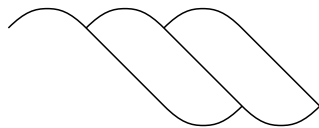
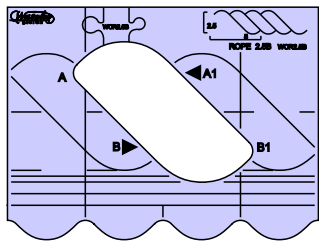

WCR 2.5B 2.5" \$28.00

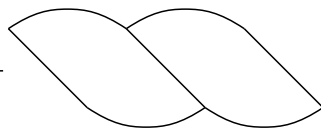
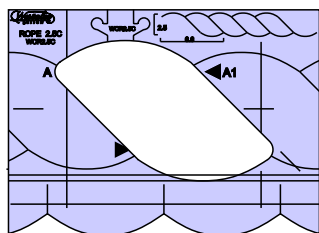

WCR 2.5C 2.5" \$28.00

# CONTINUOUS ROPE AND ECHO

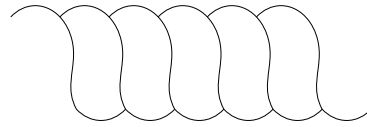
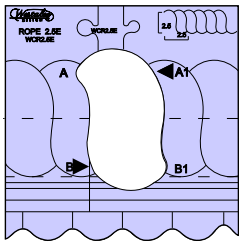

**WCR 2.5E**

**2.5" \$24.00**

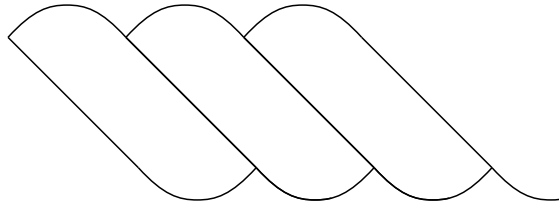
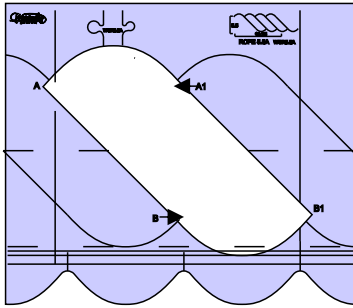

**WCR 5.5E**

**5.5" \$45.00**

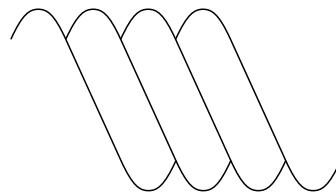
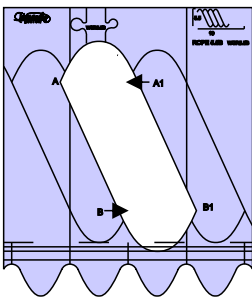

**WCR 5.5E**

**5.5" \$35.00**

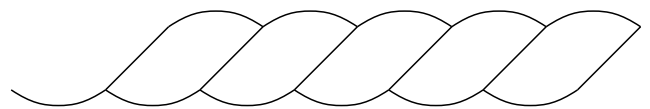
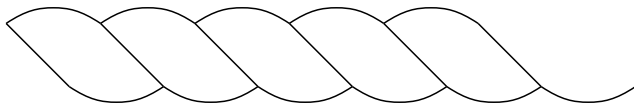

The Continuous Rope can be stitched from Left to Right or Right to Left

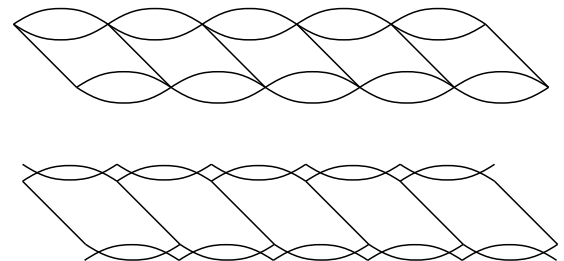
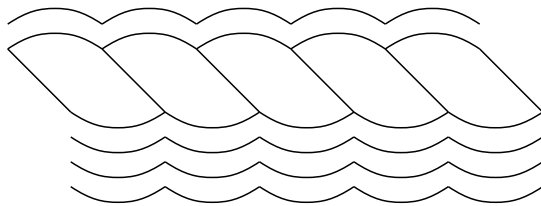

Use the Echo on th Tool to Echo the Rope

Overlay the Echo

Use the Continuous Rope in Sashings and Borders

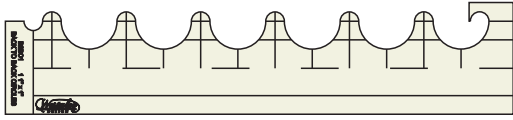

B2BC-1  
\$22.00

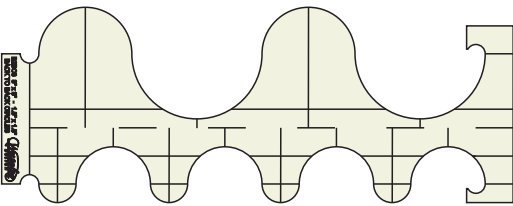
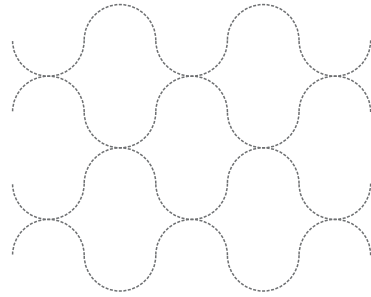
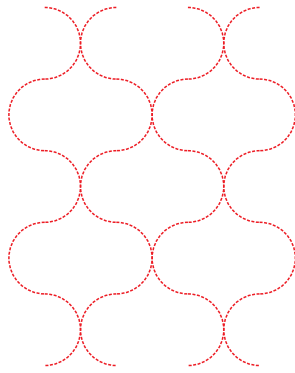

B2BC-3  
\$28.00

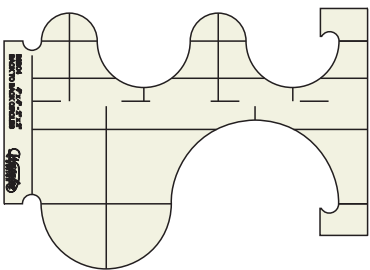
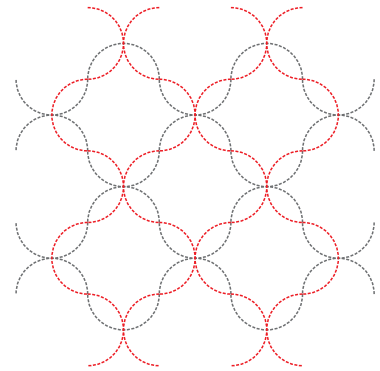
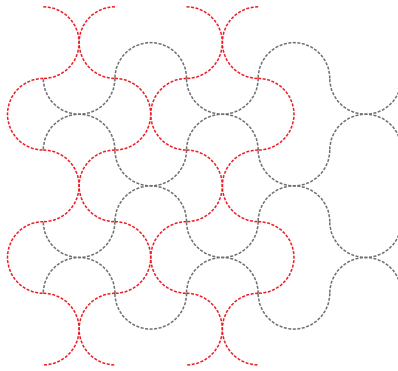

B2BC-4  
\$28.00

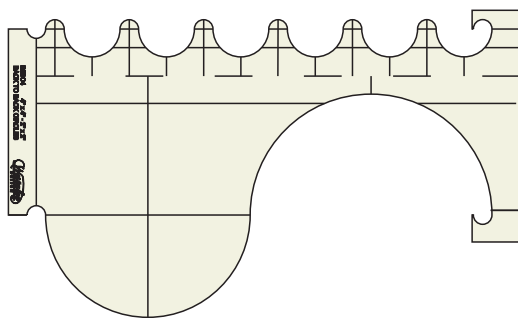
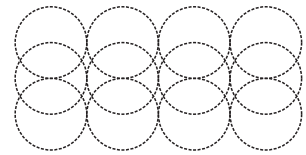
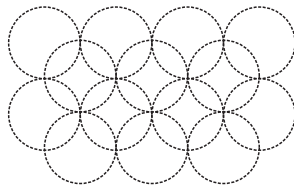

B2BC-6  
\$34.00

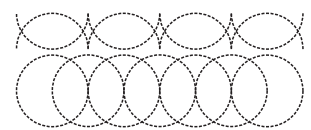
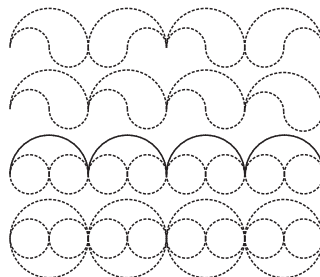

# LINE WORKS

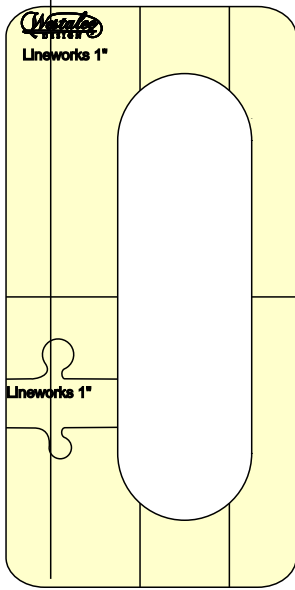

LW 1  
\$25.00

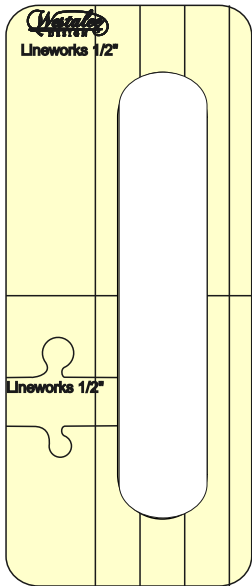
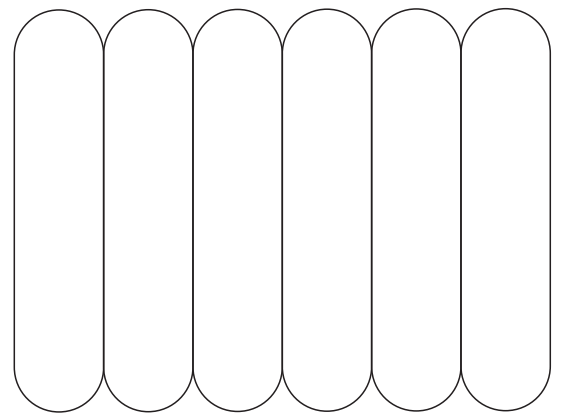
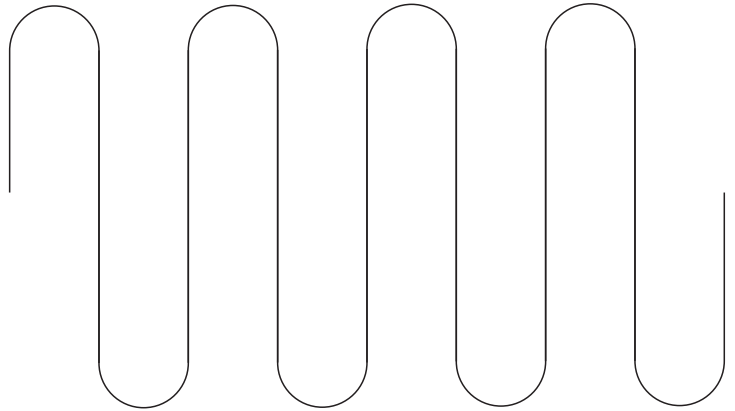

LW .5  
\$20.00

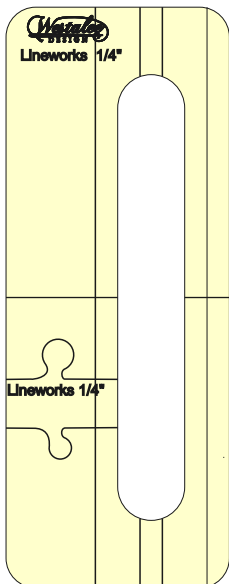
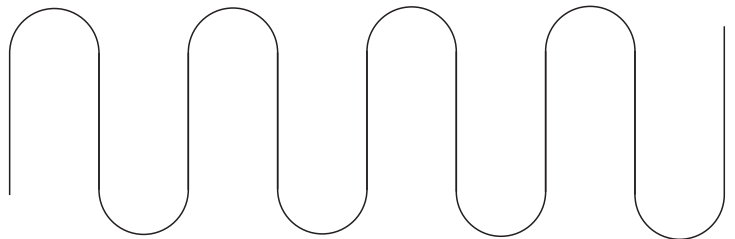

LW .25  
\$20.00

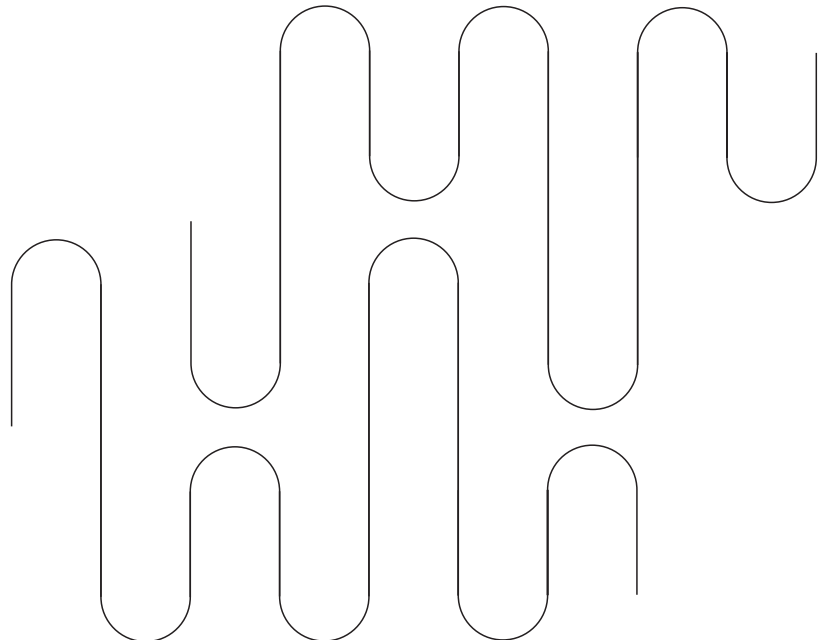





I was stitching and Echo around a Spin-e-fex design using a curved ruler on my domestic machine. The 1/4" was easy, but when stitching the 1/2" and 3/4"echo I decide to try our Inner Circles for Longarm machines (we had been making this tool since 2009) and I use them often. Well the tools worked like a dream and with a little alteration they fit our Ruler foot perfectly.

For the Westalee Ruler Foot  
WFEG \$10.00

**STABLE TAPE**

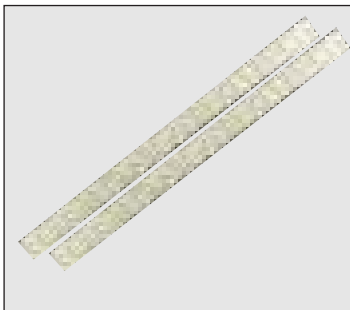

Stable Tape is a self adhesive tape to help keep rulers and templates in place.  
Great for both domestic and longarm users.

Packets of 5 Strips - cut to size

ST \$10.00



CONTINUOUS BORDERS

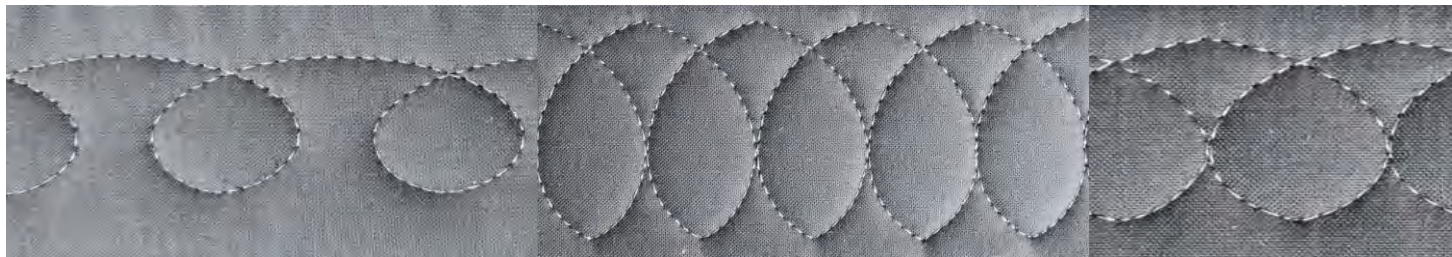

Continuous Border Loop

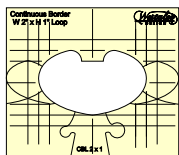

CBL 2-1  
\$20.00

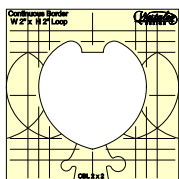

CBL 2-2  
\$20.00

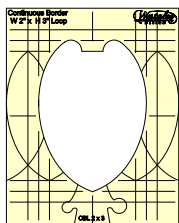

CBL 2-3  
\$22.00

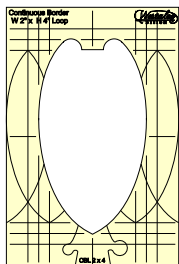

CBL 2-4  
\$22.00

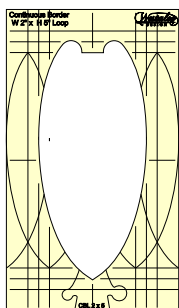

CBL 2-5  
\$24.00

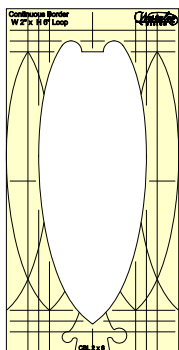

CBL 2-6  
\$28.00

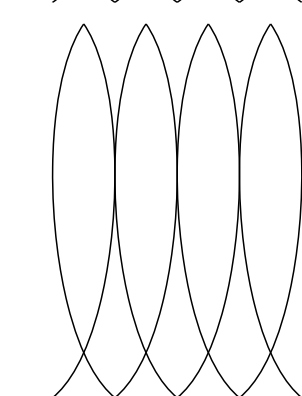
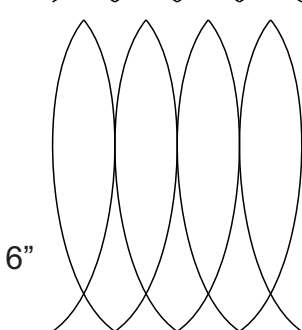
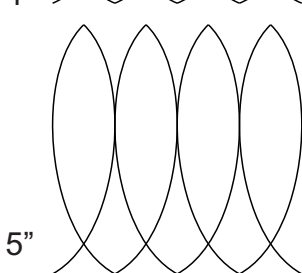
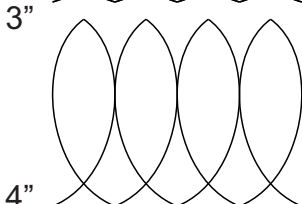
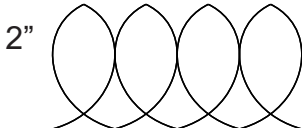
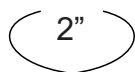

Continuous Border Loop 1

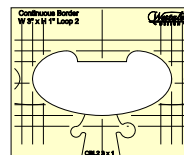

CBL2 3-1  
\$20.00

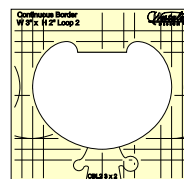

CBL2 3-2  
\$20.00

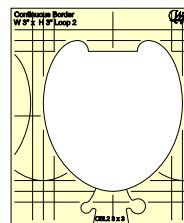

CBL2 3-3  
\$22.00

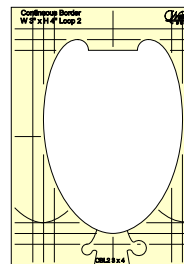

CBL2 3-4  
\$22.00

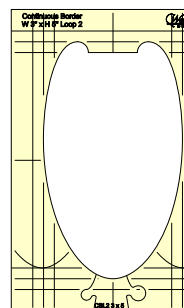

CBL2 3-5  
\$24.00

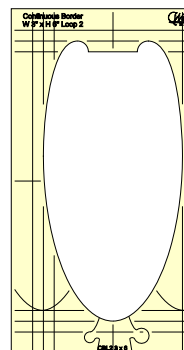

CBL2 3-6  
\$28.00

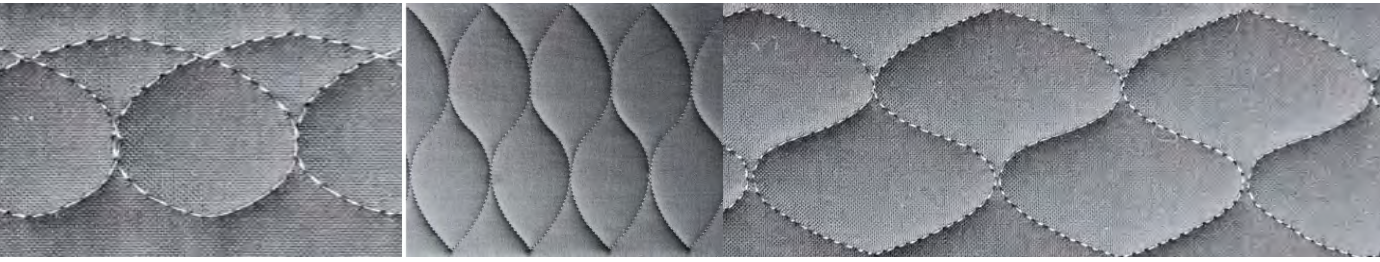

Continuous Border Loop 2

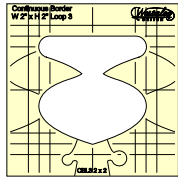
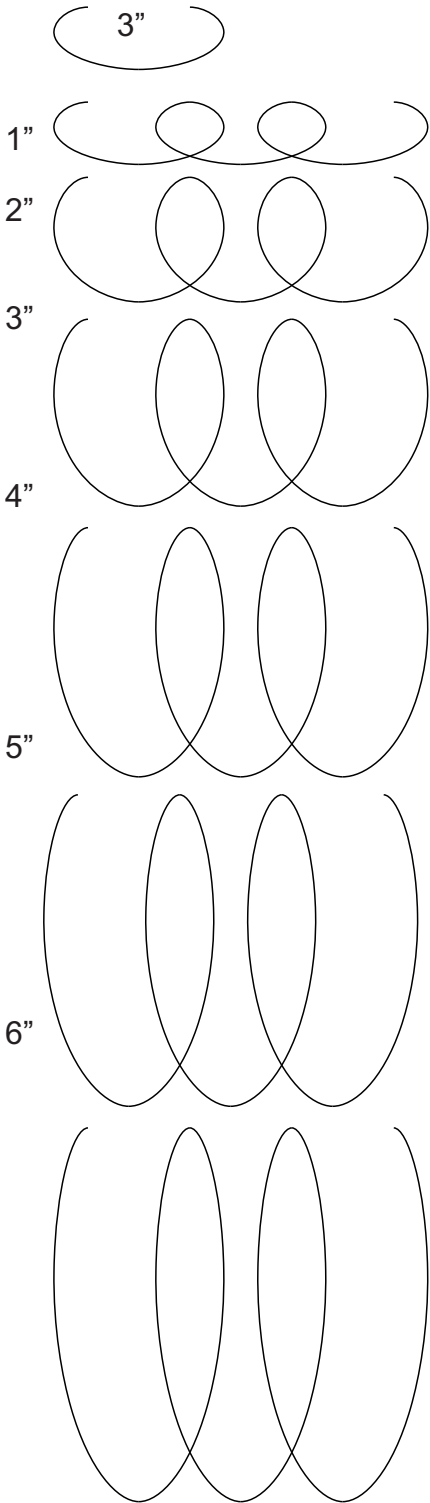

CBL3 2-2  
\$20.00

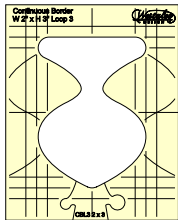

CBL3 2-3  
\$20.00

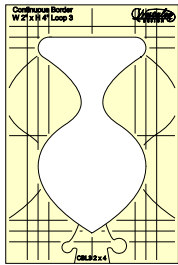

CBL3 2-4  
\$22.00

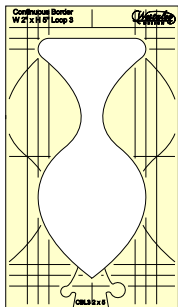

CBL3 2-5  
\$25.00

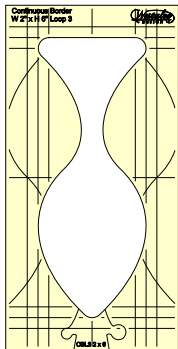

CBL3 2-6  
\$28.00

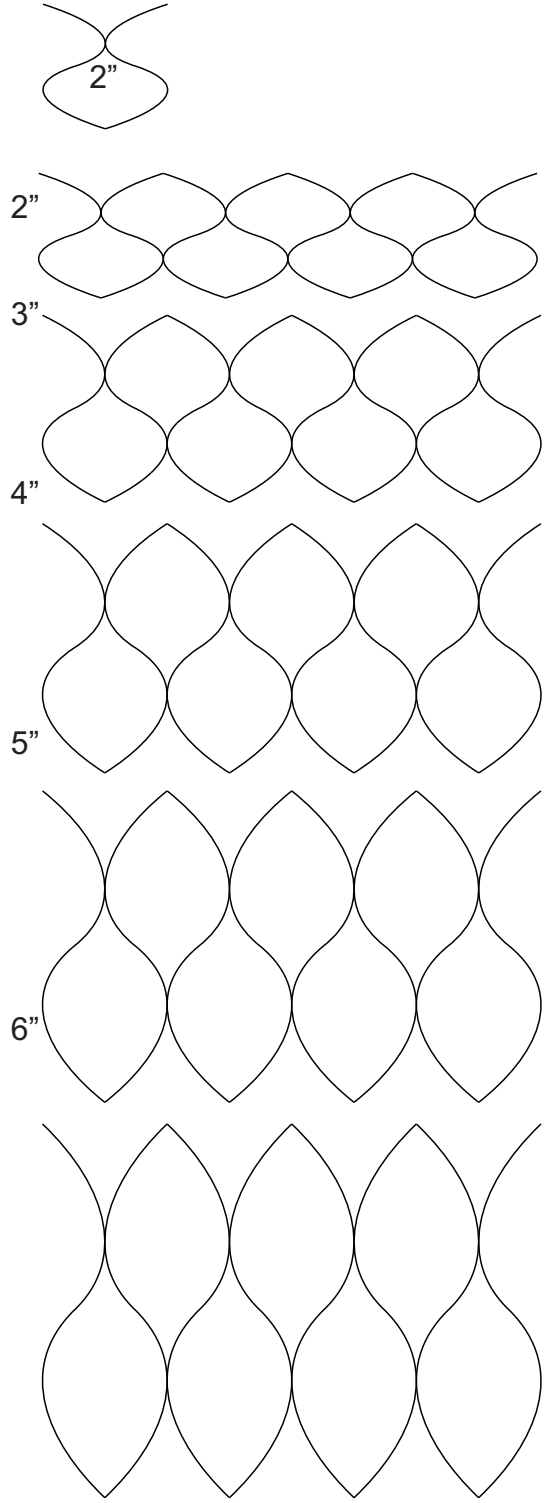

# CORNER MARK CIRCLES

The etched reference lines are marked to align with the corner of the block.  
Marked in 1/4" increments

These fabulous tools can be used to create many new designs.

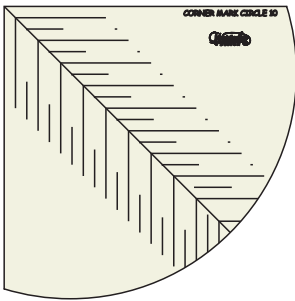
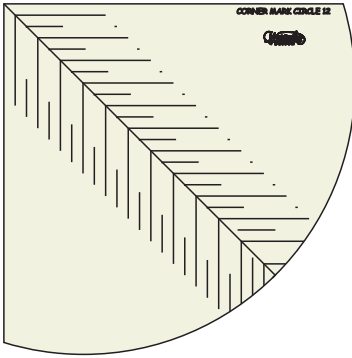
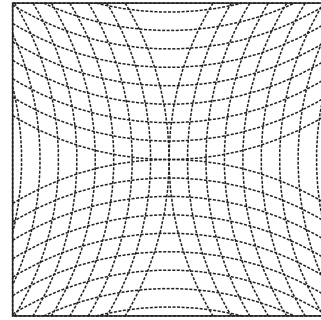

CMC-1 Set of 2  
\$32.00

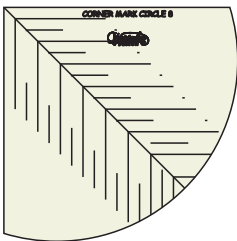

CMC-2 Set of 3  
\$28.00

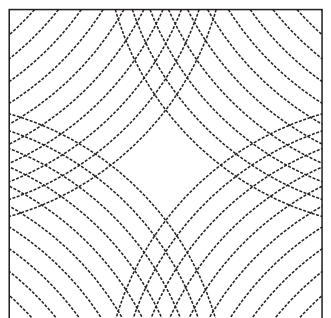
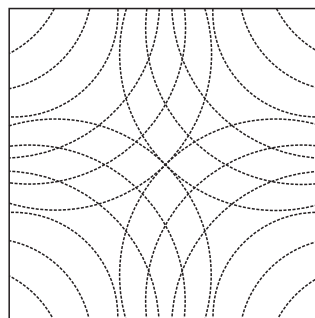
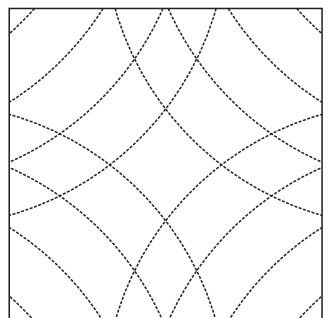
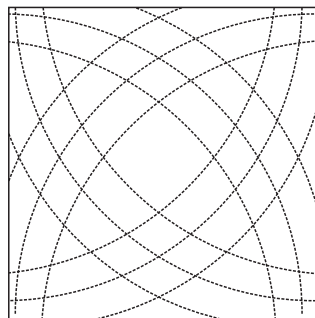
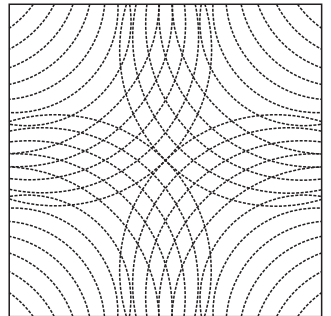
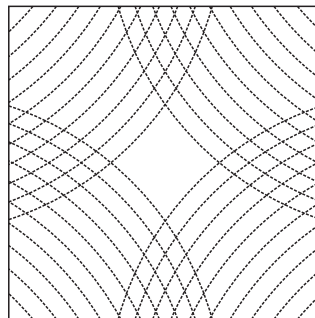
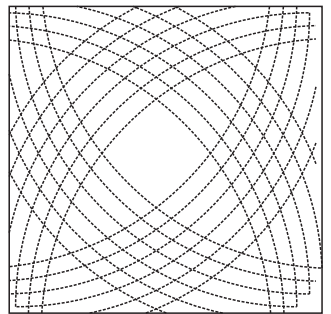
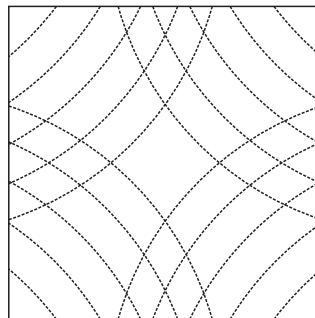

# CORNER MARK OVALS

The etched reference lines are marked to align with the corner of the block.  
 Marked in 1/4" increments

These fabulous tools can be used to create many new designs.

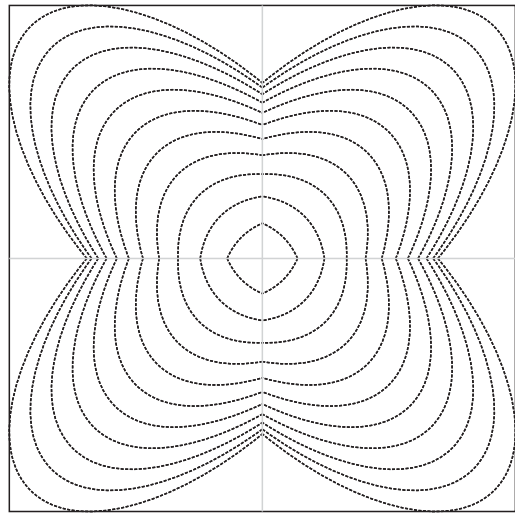
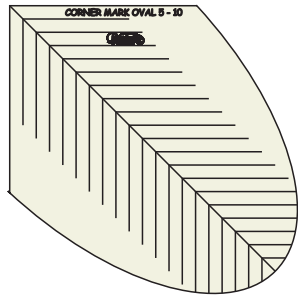
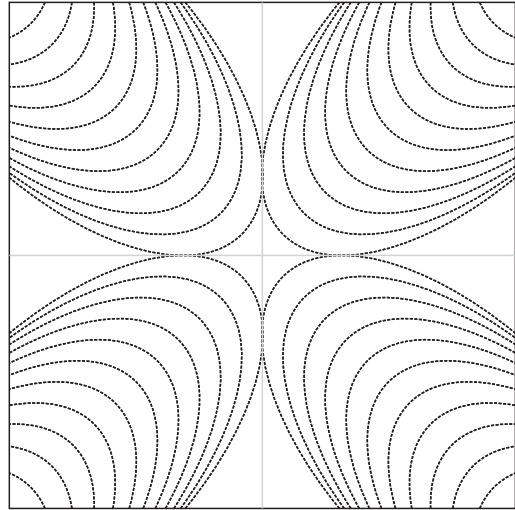
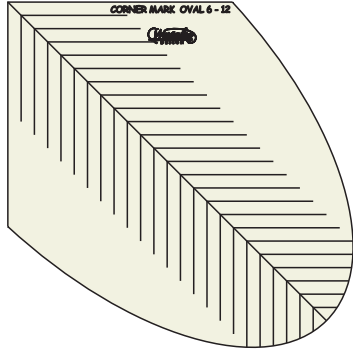

CMO-1 Set of 2  
 \$30.00

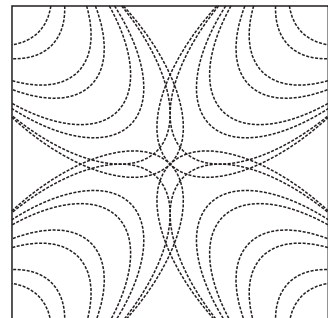
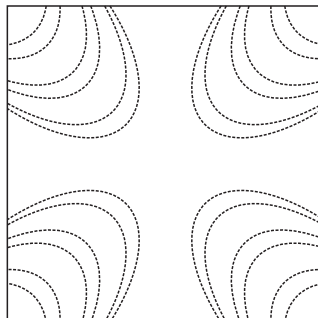
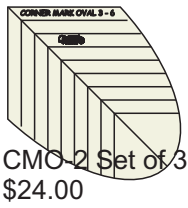
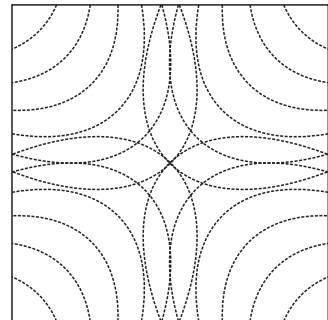
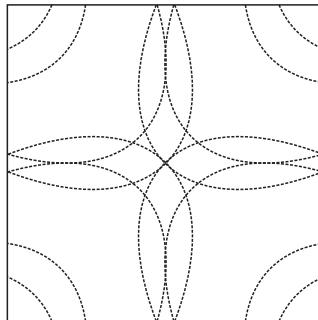
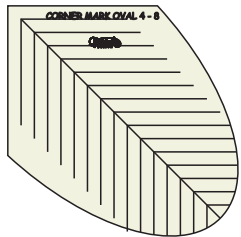

CMO-2 Set of 3  
 \$24.00



# BORDER TOOLS

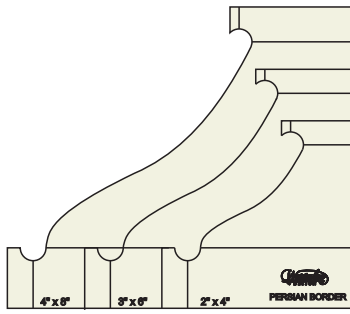

PB  
\$26.00

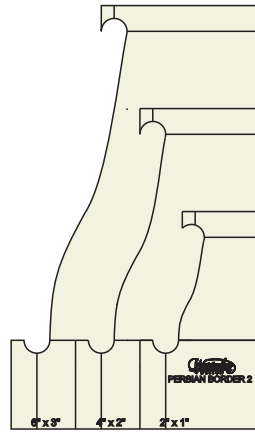
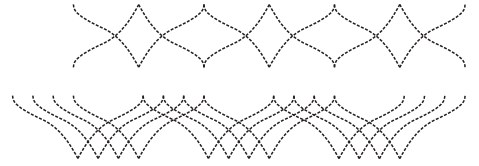
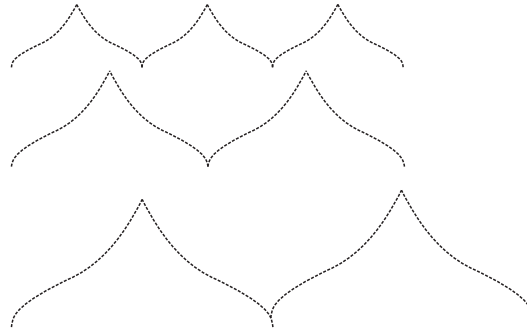

PB-2  
\$28.00

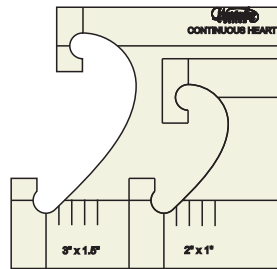
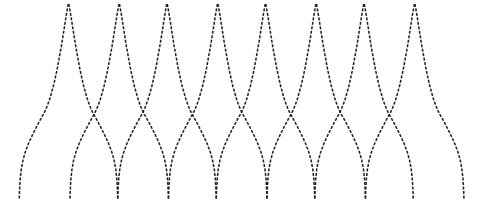
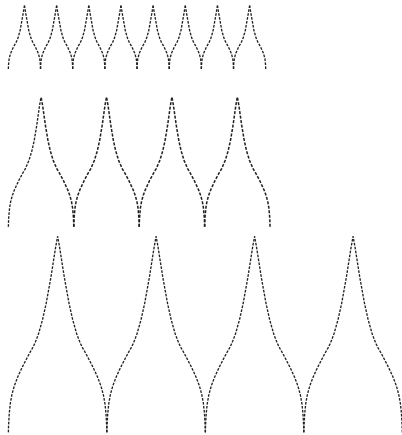

CHB  
\$20.00

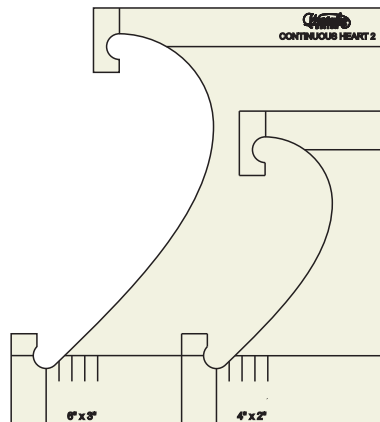
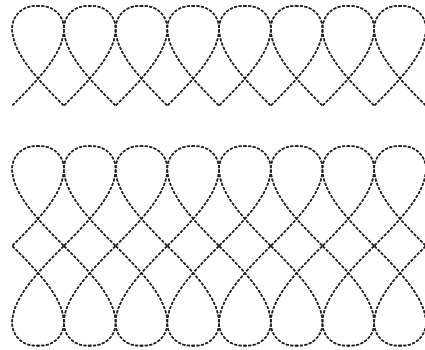

CHB-2  
\$30.00

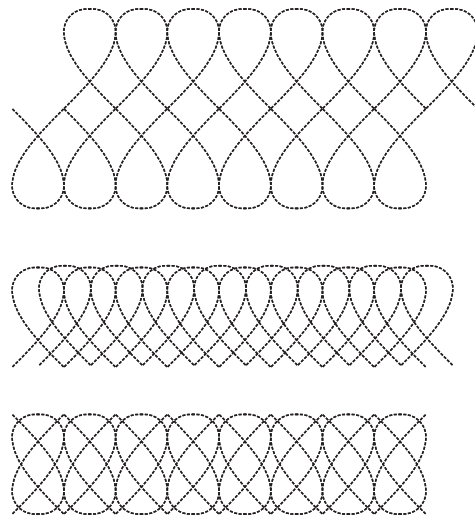

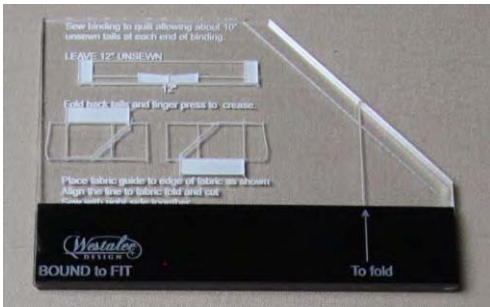

Finishing the binding can be daunting, after all the work is done. The final seam in the binding can be frustrating and difficult to get right. Bound To Fit makes it easy. For binding cut up to 2 1/2"

Full video instructions available to download [www.westalee.com.au](http://www.westalee.com.au)

BTF  
\$15.00

### STITCHING LINE DISCS



SLD  
\$6.00

To mark quilts for hand quilting or quilting on a sewing machine. Use the Westalee Stitching Line Discs (little circles to draw a 1/4" from the edge of Template - the stitching line) and your favourite marking tool. There are 4 different sizes and 2 of each in the pack.

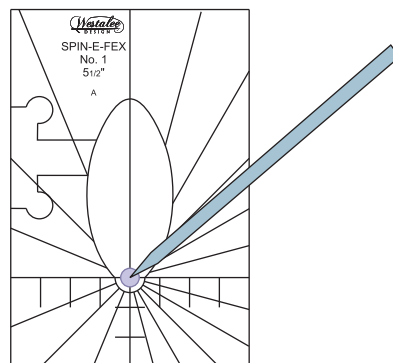

1  
6  
6  
5  
4  
3  
2  
1  
1  
2  
3  
4  
5  
6  
6  
5  
4  
3  
2  
1

# CURVED CROSS HATCH

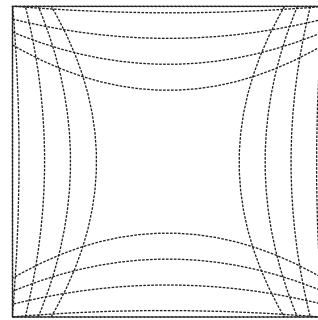
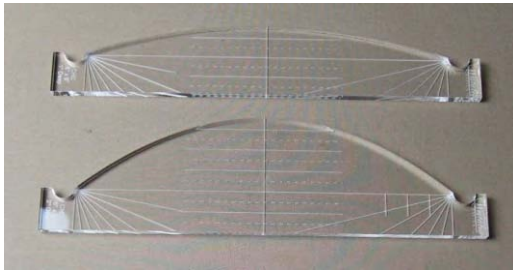

The curve on this Crosshatch ruler is measured across the diagonal of a 6" square. Allowing you to create amazing designs for blocks and borders.



CHC-1 \$22.00

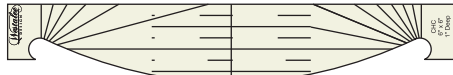

CHC-2 \$22.00

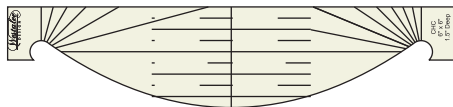

CHC-3 \$22.00

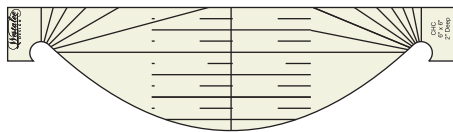

CHC-2 \$22.00

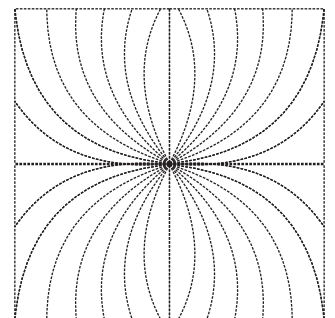
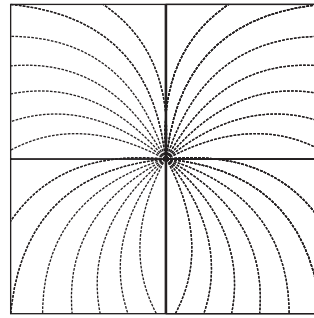
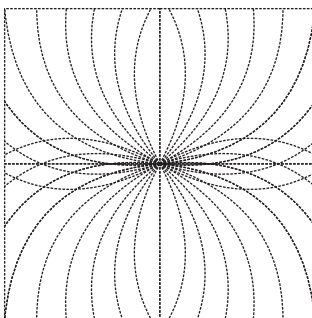
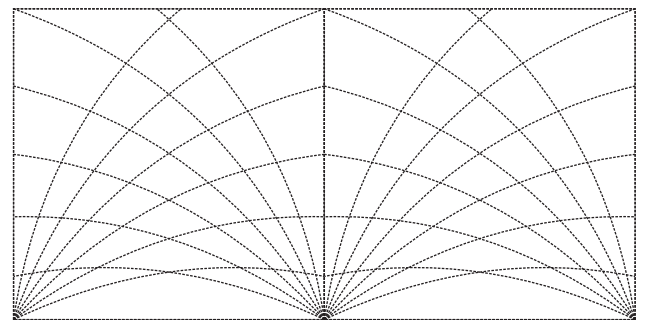
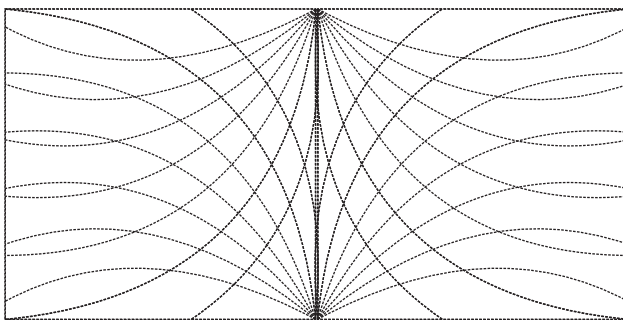
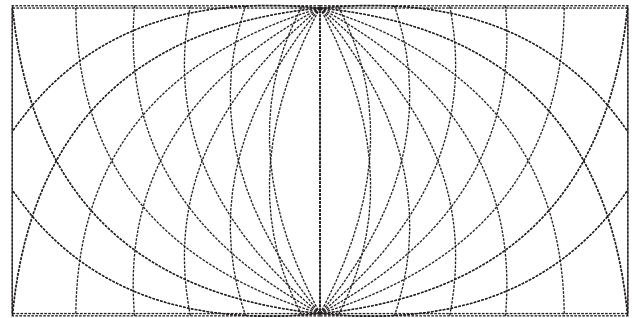
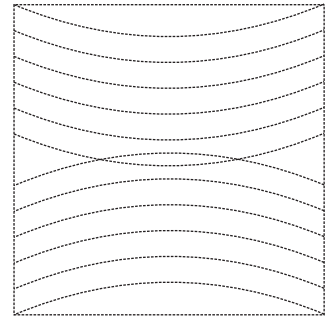
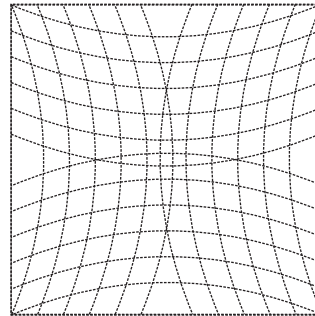



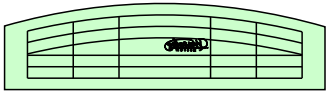

6" Curve 1 C6 1 \$20.00

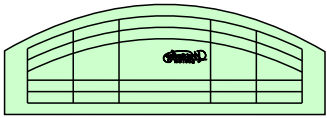

6" Curve 2 C6 2 \$20.00

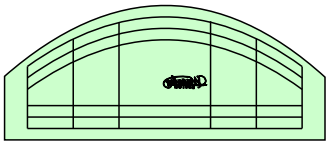

6" Curve 3 C6 3 \$20.00

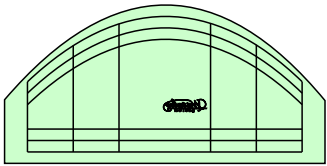

6" Curve 4 C6 4 \$20.00

The Inside Out Curves stitch the same curve on both sides of the tool

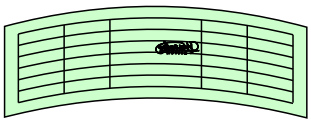

6" Inside Out Curve 1 C6 1 \$20.00

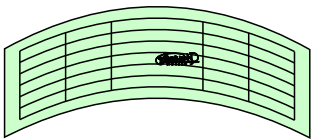

6" Inside Out Curve 2 C6 2 \$20.00

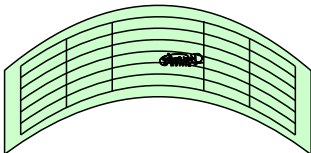

6" Inside Out Curve 3 C6 3 \$20.00

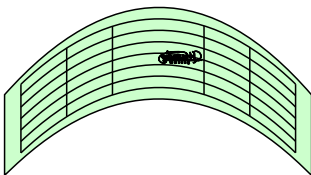

6" Inside Out Curve 4 C6 4 \$20.00

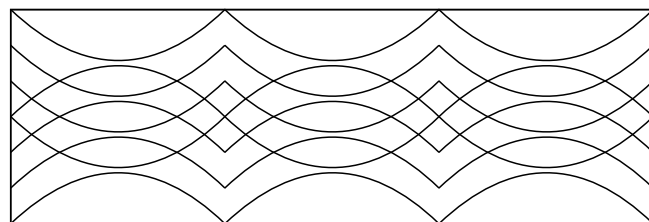
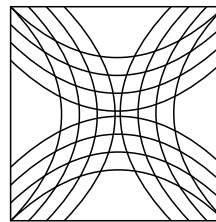
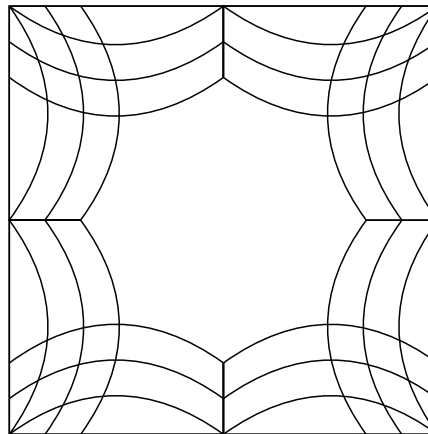
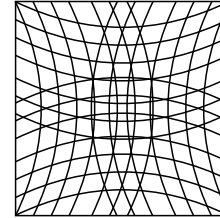
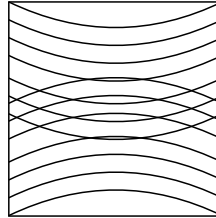
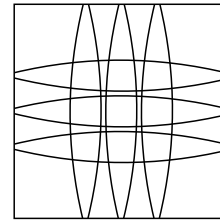
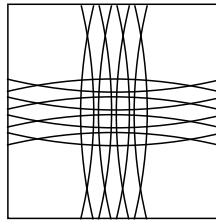

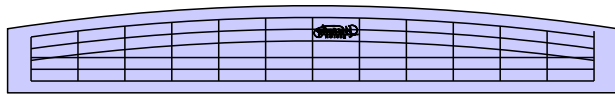

12" Curve 1 C12 1 \$25.00

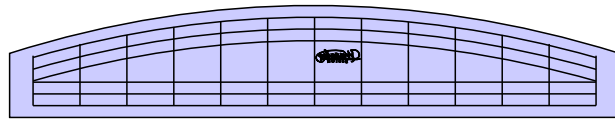

12" Curve 2 C12 2 \$25.00

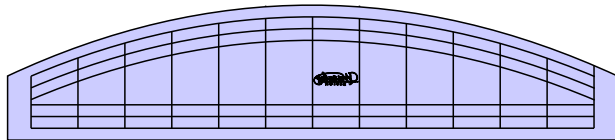

12" Curve 3 C12 3 \$25.00

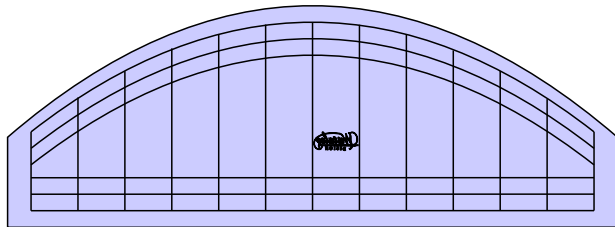

12" Curve 4 C12 4 \$25.00

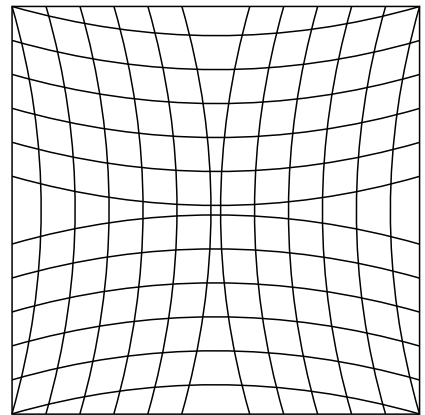
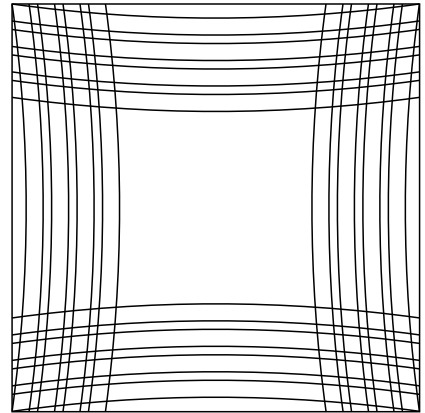

The Inside Out Curves stitch the same curve on both sides of the tool

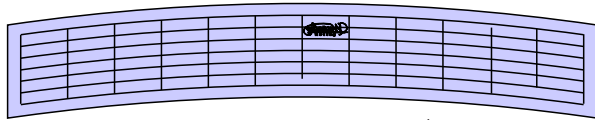

12" Inside Out Curve 1 C12 1 \$25.00

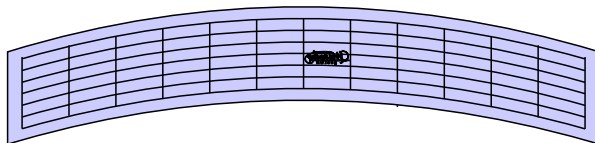

12" Inside Out Curve 2 C12 2 \$25.00

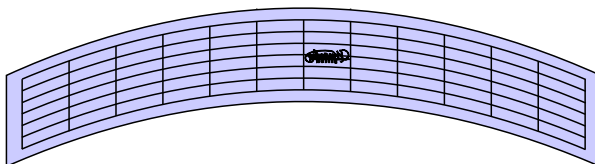

12" Inside Out Curve 3 C12 3 \$25.00

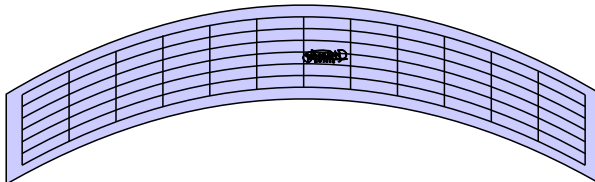

12" Inside Out Curve 4 C12 4 \$25.00

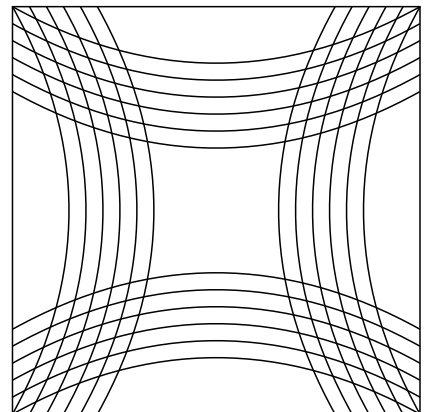
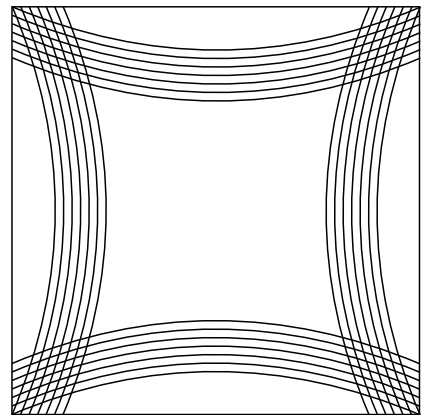

Both of the curves (inside and outside) will stitch the line the Arcs.  
It is easier to stitch in side a curve than outside the curve.

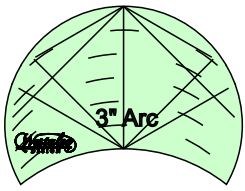

3" Arc      3A    \$10.00

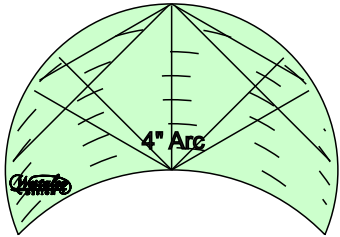

4" Arc      3A    \$12.00

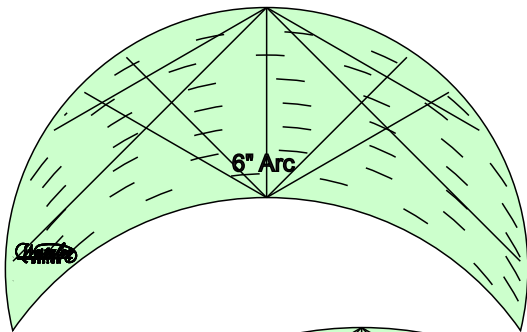

6" Arc      3A    \$18.00

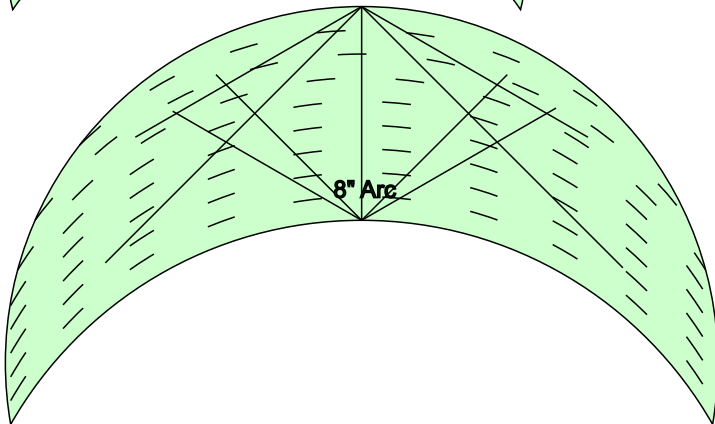

8" Arc      3A    \$20.00

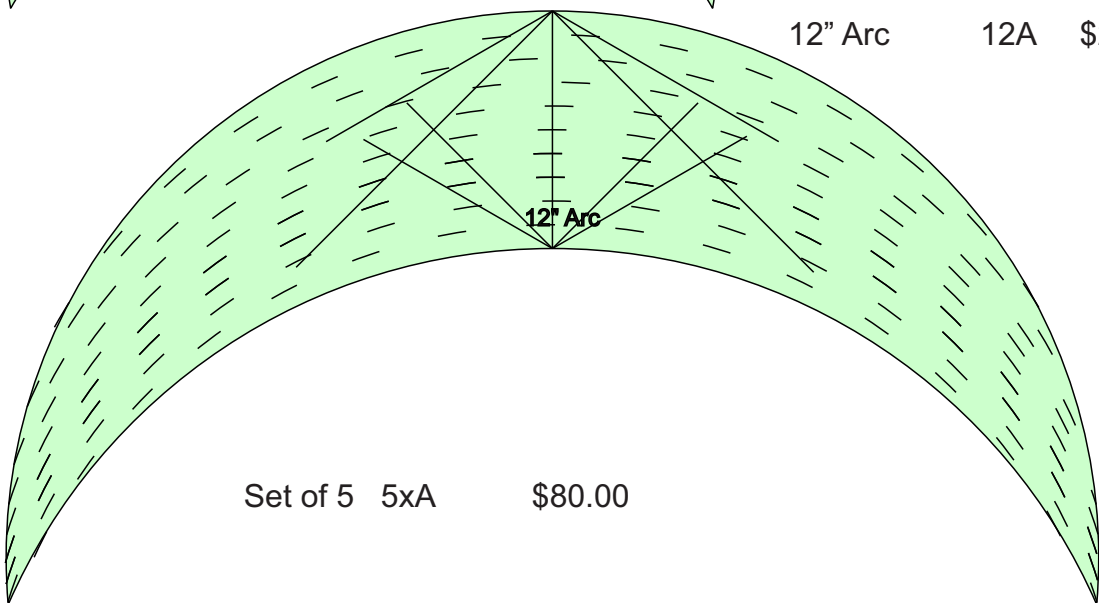

12" Arc      12A    \$28.00

Set of 5    5xA      \$80.00

# SERPENTINE

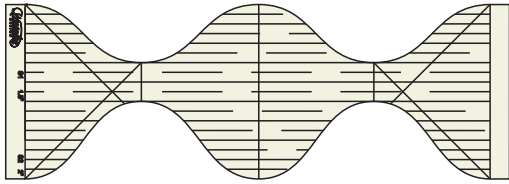

S1-2  
\$25.00

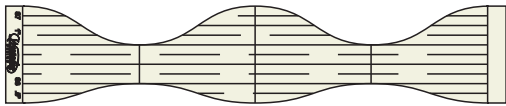

S7-8  
\$25.00

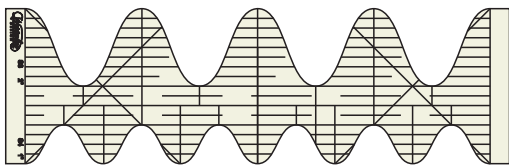

S3-4  
\$25.00

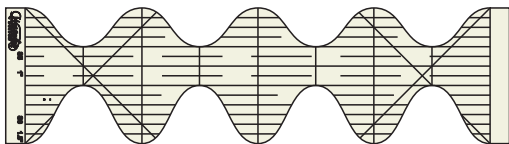

S5-6  
\$25.00

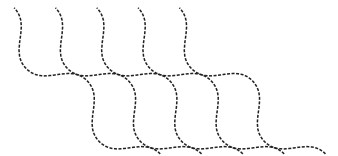
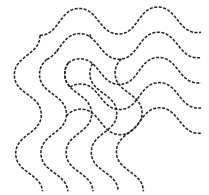
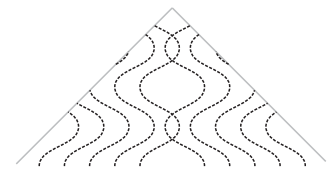
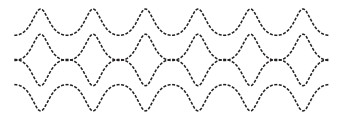
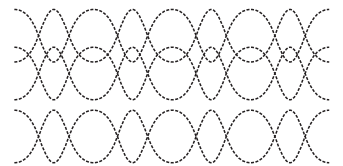
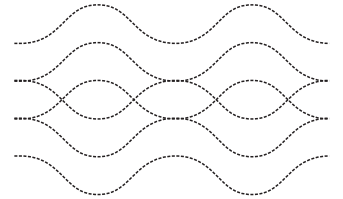
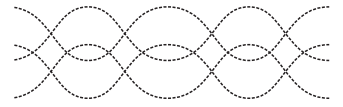
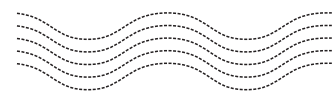
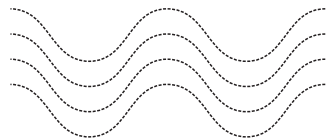
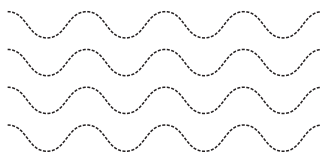
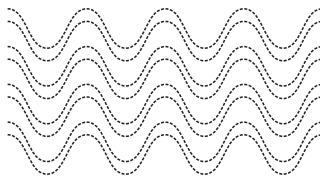
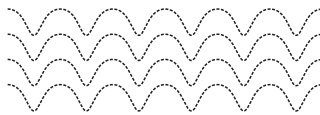
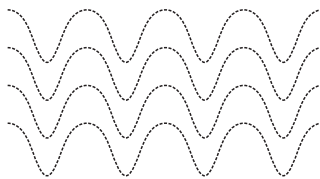
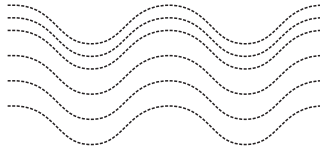
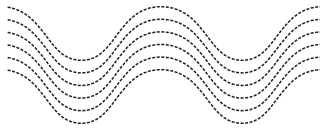

## CROSS HATCH GUIDE

For use on quilting frames only

This tool requires about 1 minute to set the angle and it is ready to use. The Black Fence is placed against the rolled quilt near the neck of the Long Arm Machine and with minimal pressure you can use the guide to stitch your cross hatch lines. The tool is not locked down and does not require any marking on the quilt.

The Guide enables complete flexibility when working around appliqué' while maintaining true cross hatch lines. The Laser cut lines in the Guides will allow you to keep the cross hatching accurate. Made of 8mm acrylic

Now available in 6mm acrylic for machines with low shank.

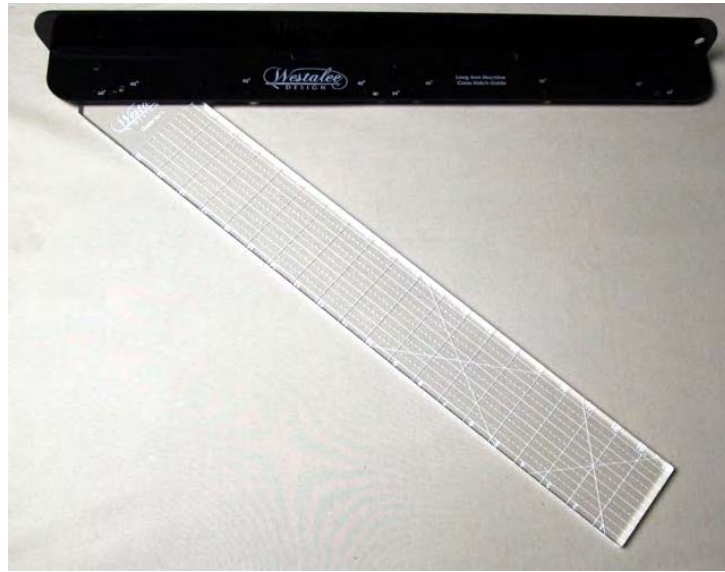

We have a range of specialty curve guides for the Cross Hatch Guide available  
 22" - \$42.00  
 16" - \$39.00

CHG  
 \$89.00

## MINI CROSS HATCH GUIDE

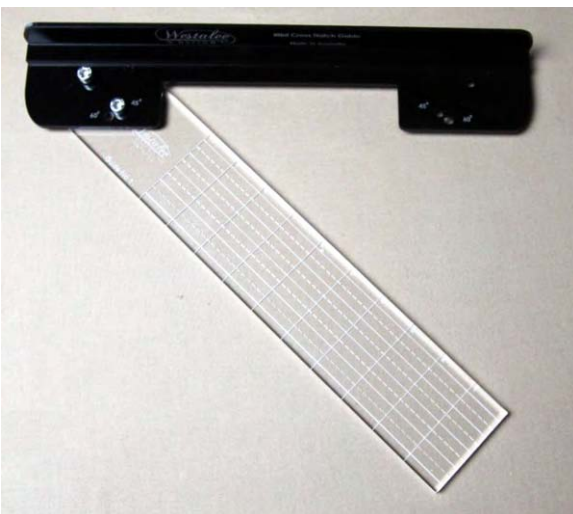

The Mini Cross Hatch Guide is for midarm and domestic machines in frames (*must have a Ruler foot & extension table*)

Made in 6mm acrylic

MCHG  
 \$49.00

## CORNER SELECTOR

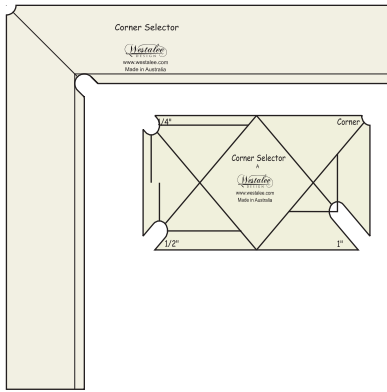

CS-1  
\$40.00

Use to find corners and set designs when using computer aided machines.

## MINI CLAMSHELL



The Mini Clam has 4 different sized half circles (or clams) - one on each side of the ruler - 1", 2" 3" and 4".

BBCS  
\$22.00

Designed by Belinda Betts

## MINI CURVE

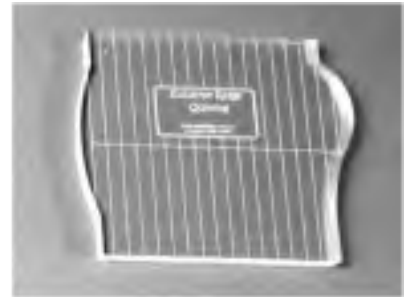

The tool has parallel lines a 1/4" apart, along with a line indicating the center of the curve which can be used to continuously curve the inside of a square or triangle.

BBMC  
\$12.00

## THE RIGHT ANGLE

Designed by Tonia Brooks

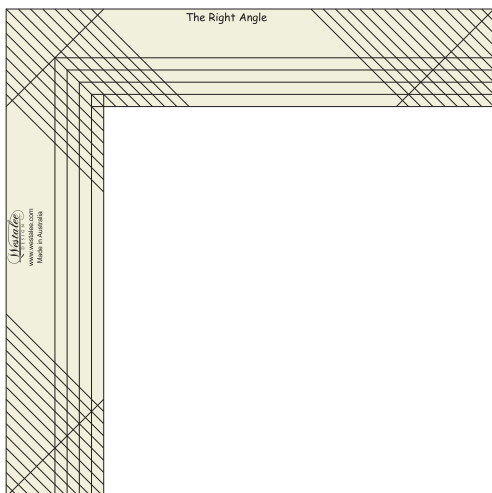

A handy ruler for stitching 45° lines in small borders and more.

The Right Angle is etched with 1/4" lines and 45° angles.

TRA  
\$26.00

Each tool has 1" - 2" - 3" - 4" - 5" - 6" curves

To make the most of these tools use the 4 together and play  
 The curves begin and end with a space for the hopping foot to rest

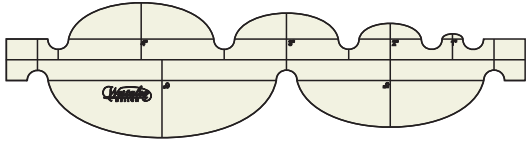

MAC-1 Shallow Ovals \$28.00

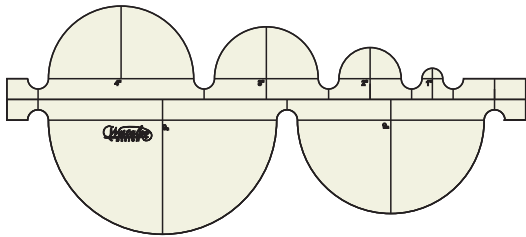

MAC-2 Circles \$28.00

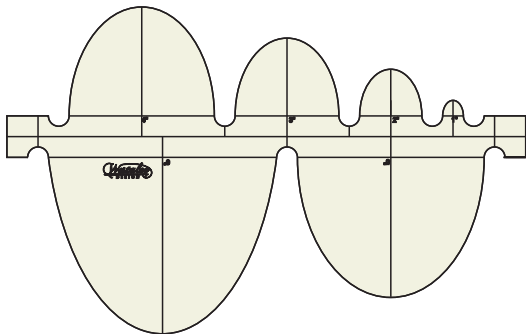
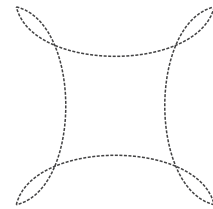
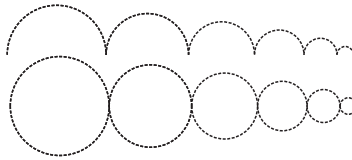

MAC-3 Deep Ovals \$30.00

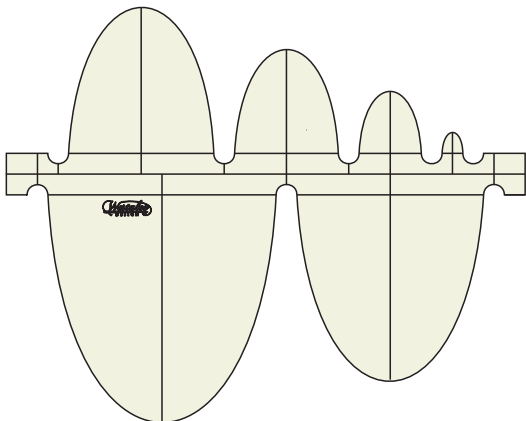
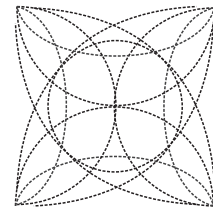
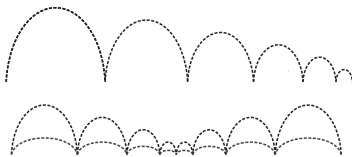

MAC-4 Deep Ovals 2 \$35.00

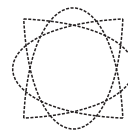
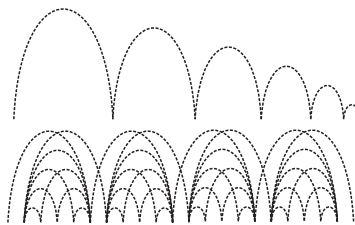

# CLAMSHELL RULERS

Clamshell - Oval Clamshell - Squat Oval Clamshell - Persian Clamshell

12" in Length

1" (12 bumps per 12" length) - 1 1/2" (8 bumps per 12" length) - 2" (6 bumps per 12" length)

3" (4 bumps per 12" length)

## PERSIAN CLAMSHELL

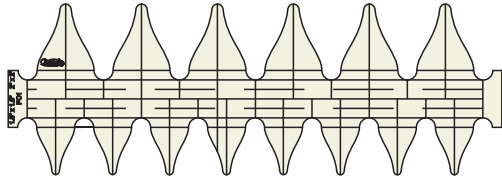

PC-01  
\$26.00

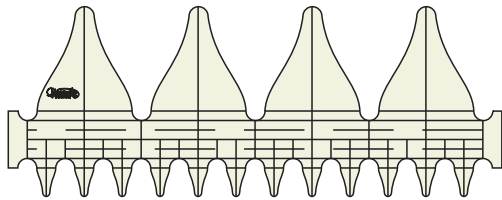
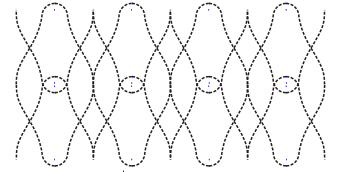
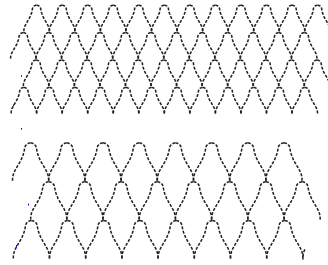

PC-02  
\$28.00

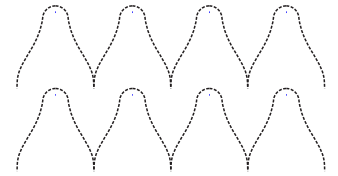
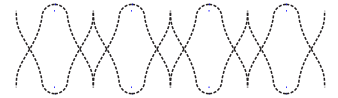
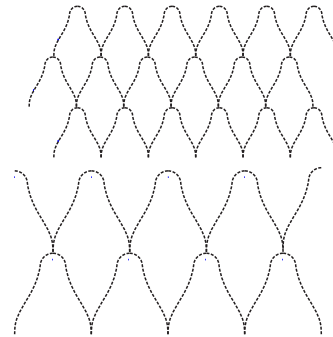

## SQUAT OVAL CLAMSHELLS CLAMSHELL

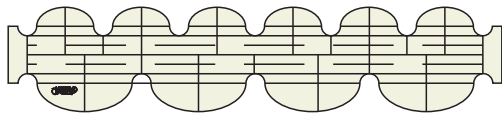

SOC1  
\$26.00

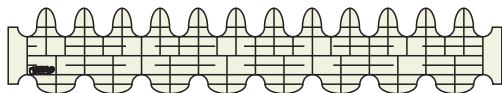
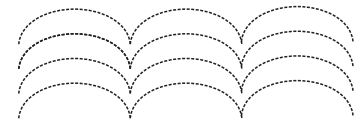
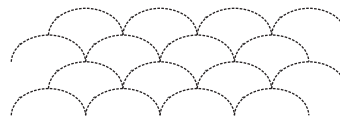
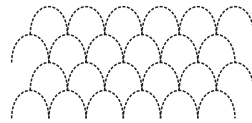

SOC2  
\$26.00

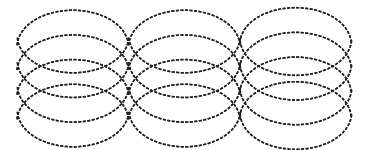
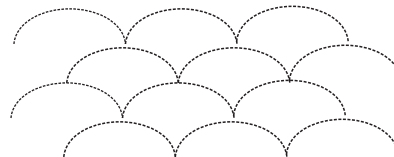



# CLAMSHELLS

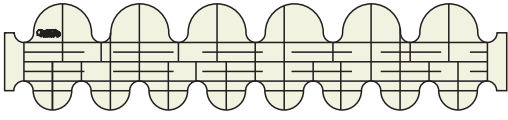

Cc1  
\$26.00

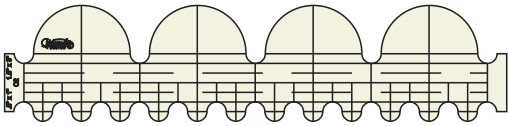
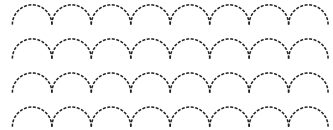
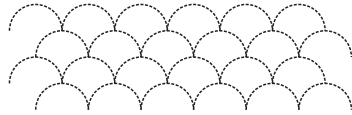

CC2  
\$26.00

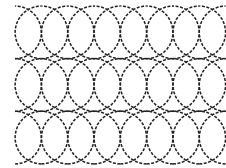
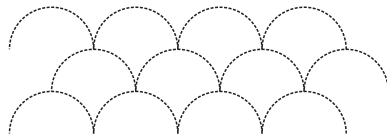

# OVAL CLAMSHELLS

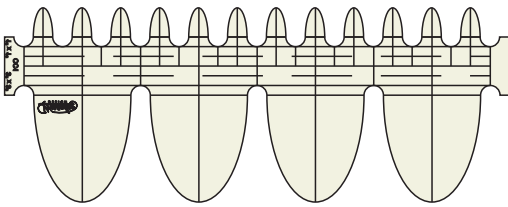

OC-1  
\$28.00

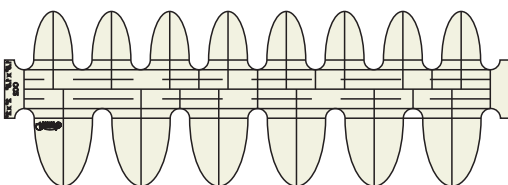
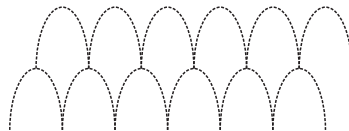
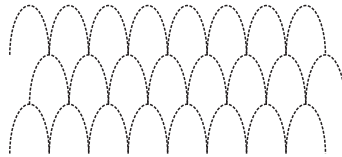
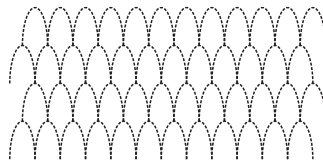

OC-2  
\$28.00

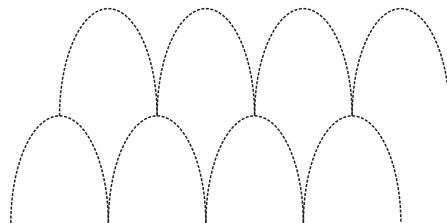

## 1/2" RULER FOOT for Gammil Longarm Quilting Machines

You must use a Ruler Foot when working with rulers and templates when stitching directly onto a quilt.

Ideally the Ruler Foot should measure 1/2" across the collar with the needle stitching at 1/4" from the ruler or template edge. This will make it easy to calculate spacings across a block or quilt.

Nolting, A1, Handy Quilter, Innova and Prodigy machines all have a true 1/2" round Ruler Foot. Gammil and APQS have a 9/16" Ruler Foot, which will stitch out at 9/32" from the ruler or template edge.

At Westalee Design we have been making all our templates since 2008 to suit both sizes. Our templates are made Machine specific and you will achieve the same result for either sized foot.

### **We have Great News for Gammil owners.**

We now manufacture a 1/2" round Ruler Foot to stitch a 1/4" from the template edge to be used with 1/4" or 3/8" thick templates.

Made from Stainless Steel Composite material, with good visibility from the front and back, supported at the sides, there is no way the Ruler Foot can slip under or over a template.

**Now available for Gammil Machines**

**\$76.00**



9/16" Gammill Foot



1/2" Ruler Foot by Westalee Design

We make a large selection of Straight Rulers in different Lengths and Widths  
 And if you have a special request just ask and we will make that for you.

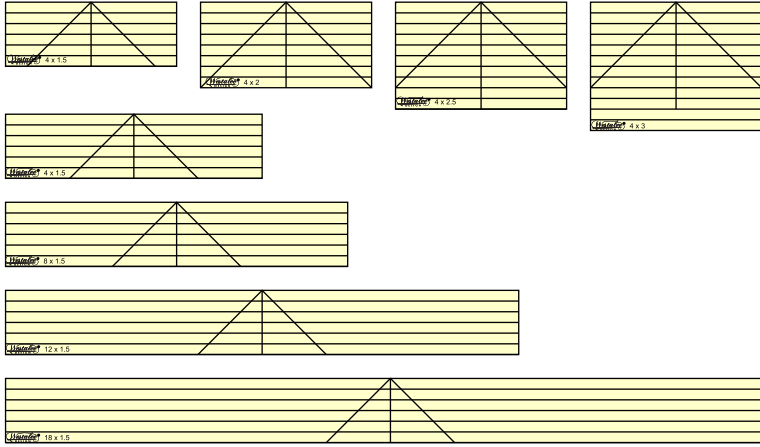

1.5 x 4	\$8.00	2 x 4	\$8.00	2.5 x 4	\$8.00	3 x 4	\$8.00
1.5 x 6	\$10.00	2 x 6	\$10.00	2.5 x 6	\$10.00	3 x 6	\$10.00
1.5 x 8	\$12.00	2 x 8	\$12.00	2.5 x 8	\$12.00	3 x 8	\$12.00
1.5 x 12	\$16.00	2 x 12	\$16.00	2.5 x 12	\$18.00	3 x 12	\$18.00
1.5 x 18	\$22.00	2 x 18	\$22.00	2.5 x 18	\$24.00	3 x 18	\$24.00

Dimensions shown are in inches

For more information on how to use the  
 Westalee Ruler Foot, Quilting Templates and Rulers:

[www.sewsteady.com](http://www.sewsteady.com)

[www.youtube.com/user/Westalee](http://www.youtube.com/user/Westalee)

[www.blogwestaleedesign.blogspot.com.au/](http://www.blogwestaleedesign.blogspot.com.au/)

All Westalee Tool, The Ruler Foot, Quilting Templates, Adjustable Rulers, Westalee Guided Templates, Longarm Tools, Patterns, Books and Video Tutorials are Protected by copyright law. They are the sole property of Westalee Design Pty. Ltd. Westalee Design is a Registered Trade Mark. All material including graphics, photos and drawings are not to be used without the written approval of the owners, Westalee Design Pty Ltd.

Content & Graphics © 2005~2015

Westalee Designs by Sew Steady USA Manufacturer / Distributor Contact:  
 Phone: [800-837-3261](tel:800-837-3261) or [541-653-9121](tel:541-653-9121) Web: [WWW.SEWSTEADY.COM](http://WWW.SEWSTEADY.COM) Email: [Info@sewsteady.com](mailto:Info@sewsteady.com)

Westalee Design is Australia's largest dedicated manufacturer of  
Patchwork & Quilting Tools



for  
Domestic Sewing Machines when fitted with the Westalee Ruler Foot  
Longarm and Midarm Quilting Machines & Sit down Machines

We design in Australia, manufacture in USA - all tools are precision laser cut.

All our Rulers and Templates have etched reference lines to enable  
accuracy and versatility.

Looking for something different?

*We also specialize in making custom quilting tools.*

*If you are quilting that special quilt and require a special tool please give us a call to discuss making that tool to your design.*