

BIANCA FLOORMOUNT BATH MIXER

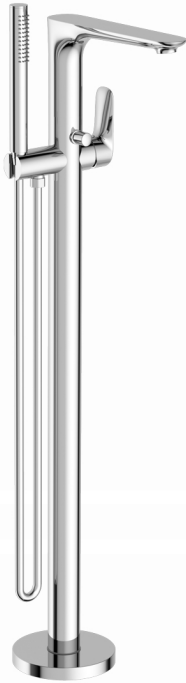

SPECIFICATION

PRODUCT CODE	YSW3215-03A
WELS RATING	3 STAR 9L/MIN
WATERMARK LICENSE	WM-060073
TEMPERATURE RATING	MIN 1°C-MAX 75°C
PRESSURE RATING	MIN 150KPa-MAX 500KPa

FINISH

NR321503aCH	chrome
NR321503aMB	matte black
NR321503aBN	brushed nickel
NR321503aGM	gun metal
NR321503aBG	brushed gold

MAINTENANCE AND CARE

All surfaces should be cleaned with mild liquid detergent or soap and water.

Do not use cream cleaners or citrus based cleaning products, as they are abrasive.

Use of unsuitable cleaning agents may damage the surface. Any damage caused in this way will not be covered by warranty

PACKAGING INCLUDES

- 1x mixer tap
- 1x hand shower (with non return valve)
- 1x pvc shower hose (with non return valve)
- 1x extension tube
- 1x floor cover plate
- 2x water pipes
- 1x mixer box
- 4x dynabolt
- 1x gloves
- 1x instruction
- 1x allen key pack

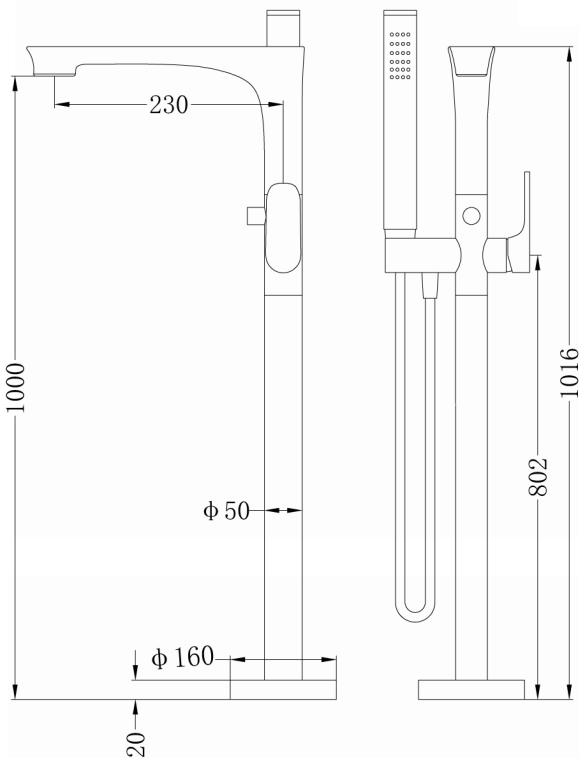

Dimensions are nominal measurements only.



Installation Instruction

Please inspection all spare parts list when you open box, if any problem, please contract with seller. Spare parts list as follow.

Part List

1. Mixer Tap x1pcs
2. Extension Tube x1pcs
3. Floor Cover Plate x1pcs
4. Water Pipes x2pcs
- 5 Mixer Box x1pcs
6. Dynabolt x4pcs
7. Hand Shower x1pcs
8. PVC Shower Hose x1pcs
9. Gloves x1pcs x1pcs
10. Instruction x1pcs
11. Allen Key Pack x1pcs
12. Leveling Plate x1pcs
13. Gradiometer x1pcs
14. Testing Plugs x2pcs
15. Non Return Valve x2pcs

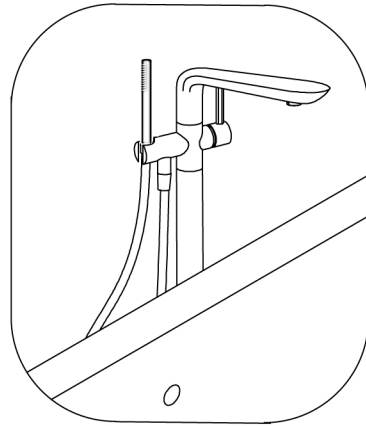
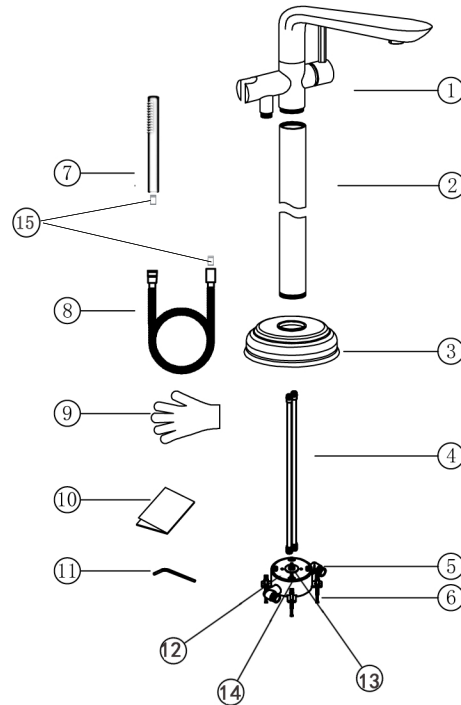

Notice: Not recommend to be installed on concrete slab

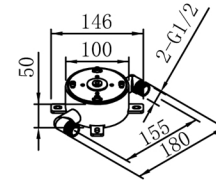

1. Mixer box should not finish more than 2mm above finish tile level



2. Connect hot and cold water use materials recommended Australian standard

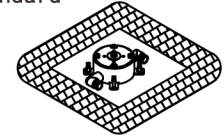

3. Adjust mixer box make sure in a level by gradiometer provided

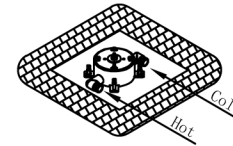

4. Test and check for water leaks

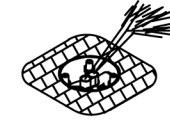

5. Undo 4 grub screws on the leveling plate and take out the gradiometer and testing plug.

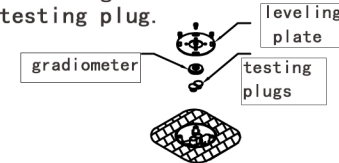

6. Attach the leveling plate onto the extension tube by provided grub screws

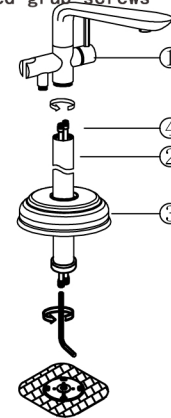

7. Screw hot and cold water pipes into the mixer body

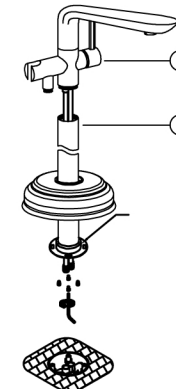

8. Fit floor cover plate onto the extension tube

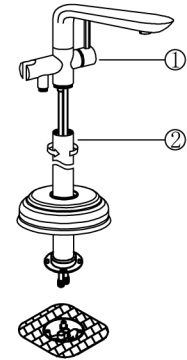

9. Screw the extension tube onto the mixer, and fix hot and cold water piper into mixer box by M5 grub screws

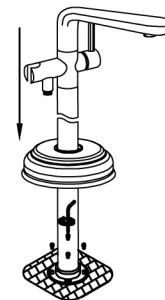

10. Connect hand shower rose with PVC hose

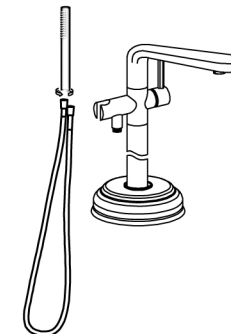

11. Flush pipes work and test, check for water leaks

