







Model Code: FRA700

Included Accessories

		
ICM	UMG	6020

Optional Accessories

		
DTA-18-316		

Dimensions

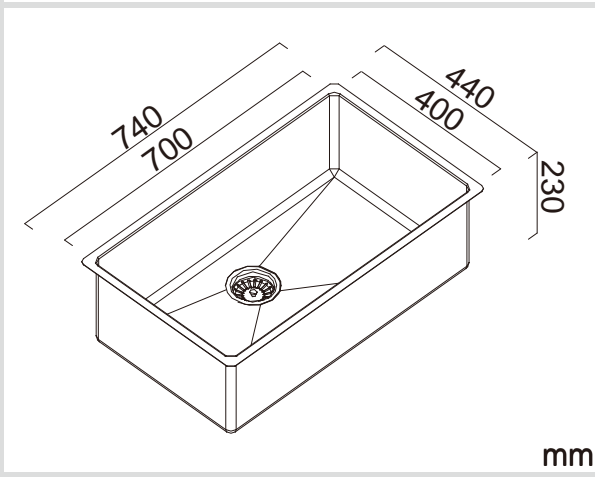

Specifications

Description	Single bowl, Inset or flush-mount Undermount Sink
Overall Sink Size	740mm x 440mm x 230mm deep
Bowl Dimensions	700mm x 400mm x 230mm deep
Drainer Length	N/A
Thickness	1.2mm
Material	Stainless steel SUS316

Installation

Fixings	Inset & Undermount clips supplied
Template	N/A
Min Cabinet Size	790mm
Waste Holes	1 x 90mm round Compatible with waste disposal
Sealing Strip	N/A

Plumbing

Waste Fittings	1 x (90mm x 2") basket waste included
Overflow	N/A

Packaging

Carton Type	EPS protection & Carton
Gross Weight	7.8Kg
Carton Size	823mm x 286mm x 513mm
Pack QTY	1

SURFACE FINISH



WASTE KIT

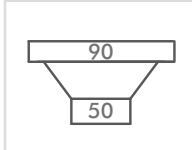

MATERIAL



INSTALLATION OPTIONS

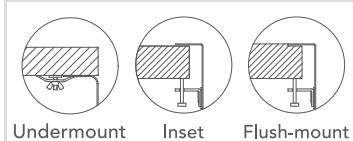

PROFILE

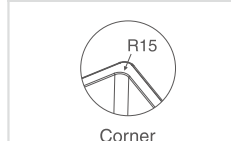

Abey are Australia's leaders in sinkware, designing and manufacturing to the world's highest quality specifications as well as sourcing and bringing you Europe's very best, leading edge designs – practical, affordable, inspirational, stylish, timeless or cutting edge. When you buy an Abey stainless steel sink you receive the highest quality and 25 year warranty. Abey and the manufacturer are continually seeking ways to improve the design specifications, aesthetic and production techniques of the products. As a result, alterations to the specifications and dimensions of the products and designs occur continually.