

Architrac® Series 94001 Assembled Set

TRACK STYLE

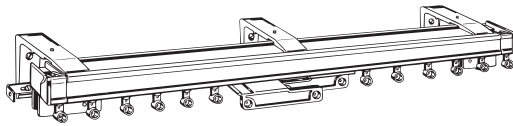

DIMENSIONS

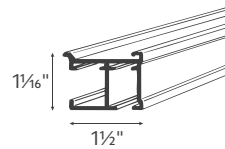

Track Overview

- AMP™ Motorization available
- Heavy duty, ball bearing pulleys
- Heavy duty, wheeled (Ripplefold™) or ball bearing (pleated) carriers
- Wall or ceiling mount available
- Multiple draw options available; manual or motorized draw
- Can be curved or bent. Not available on motorized tracks.
Curved and bent cannot be convex.

Available Track Colors

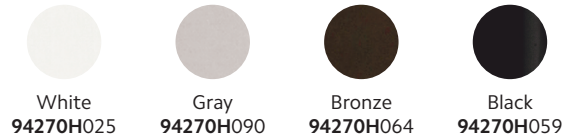

Available Draw Types



Specifications

PROFILE	DESCRIPTION	MATERIAL	HEADING STYLE	MOUNT	DRAW	MAX. TRACK SET LENGTH (FT.)	MAX. FABRIC WEIGHT (LBS.)	LBS. PER FT.		
	94001 Manual or Motorized Draw can be angular bent using 12" radius or circular curved (94001 cannot be convex curved or convex bent and AMP™ Motorization rods cannot be bent or curved)	Extruded of 0.050" 6063T5 aluminum alloy powder coat paint	Pleated, Ripplefold™	Ceiling, Wall, Recessed	One-Way	Manual	20	Manual	80	4
					One-Way	Motorized	16	Motorized	64	4
					Two-Way	Manual	40	Manual	160	4
					Two-Way	Motorized	16	Motorized	64	4

Maximum track lengths and maximum fabric weights do not apply to curved tracks. Send complete specifications to customer service for feasibility.

Installation

Install according to instructions.

Support Spacing: Place bracket at each end, place next bracket a maximum of 24" from first, then place remaining brackets at 48" intervals over the remainder of the track. Spacing may need to be shortened for heavier draperies.

WALL MOUNT

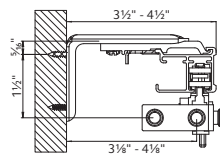

CEILING MOUNT

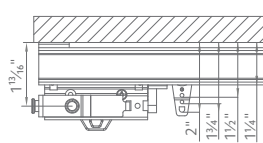

AMP™ MOTORIZATION MOUNT

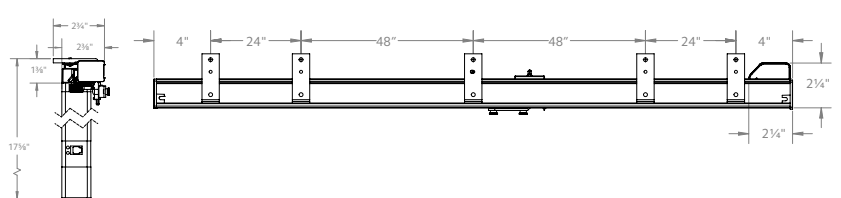

Bend Styles

All bends must include returns except corner with 90° bend. Architrac® Series 94001 with AMP™ Motorization cannot be bent or curved.

STYLE 1:
RECESS

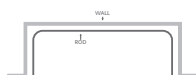

STYLE 2:
BOW



STYLE 3:
BAY



STYLE 4:
CORNER





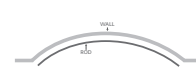





STYLE 5:
CURVED



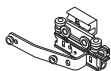

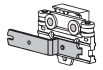
Track Components

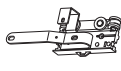
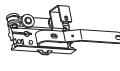







Wheeled Master Carriers

Item	Product Description	Notes
 Right 84110  Left 84111	Buttmaster Carriers Right 84110 Left 84111 Heading Style: Pleated, Ripplefold™ Color: 025 White, 059 Black	Drapery panels butt together at center, no flat areas to overlap 
 Right 84213  Left 84214	Buttmaster Carriers Right 84213 Left 84214 Heading Style: Ripplefold™ Color: 059 Black, 061 Zinc	
 Right 84103  Left 84104	Overlap Carriers Right 84103 Left 84104 Heading Style: Pleated, Ripplefold™ Color: 059 Black, 061 Zinc	
 Right 84107  Left 84108	Through Fabric Carriers Right 84107 Left 84108 Heading Style: Pleated Color: 061 Zinc	
 Right 84105  Left 84106	Over the Top Carriers Right 84105 Left 84106 Heading Style: Pleated Color: 061 Zinc	

Ball Bearing Wheeled Master Carriers

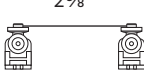
	25mm Ball Bearing Carrier 9670 Color: 025 White	
	16mm Ball Bearing Carrier 86700 Color: 025 White, 061 Gray, 064 Bronze, 059 Black	

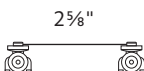
Ripplefold™ Wheeled Carriers

 1 7/8"	120% Ripplefold Carrier 82120 Color: 025 White, 059 Black	
 2 1/8"	100% Ripplefold Carrier 82100 Color: 025 White, 059 Black	
 2 3/8"	80% Ripplefold Carrier 82080 Color: 025 White, 059 Black	
 2 5/8"	60% Ripplefold Carrier 82060 Color: 025 White, 059 Black	
	Two Sides Snap Pendant 82001 Color: 025 White, 061 Gray, 064 Bronze, 059 Black,	To be used with Ripplefold wheeled carriers (82120, 82100, 82080, 82060)

AMP™ MOTORIZATION FEATURES

- ✔ AMP™ App with AMP™ USB Bridge.
- ✔ The slim design of the quiet, yet powerful motor and the position on the track allows the motor to tuck seamlessly behind your drapery panel, eliminating the need for the huge return flap needed on many competitive motorized tracks
- ✔ Easy to install motor simply clicks into the back of the coordinating track header and stays concealed behind the drapery panel
- ✔ Radio Frequency (RF) Remote and Wall Switches with fifteen channels
 - Easy programming and favorites setting
 - Smart motor sets end limits automatically
- ✔ Motor can be operated using the included cord free battery pack or directly plugged into a 120V AC outlet.
- ✔ Loss of power release disengages the motor from the carriers so the draperies may be opened in the event of an emergency
- ✔ Tug feature allows for smooth operation without the presence of a remote
- ✔ Available drapery headings:
 - Ripplefold™
 - Pleated
- ✔ Available on our most popular tracks:
 - Estate™ Traversing Rod in our Designer Metals™, Wood Trends™, Wrought Iron, Varia and Chroma Collections
 - Architrac® Series 94001

AMP™ MOTORIZATION SPECS

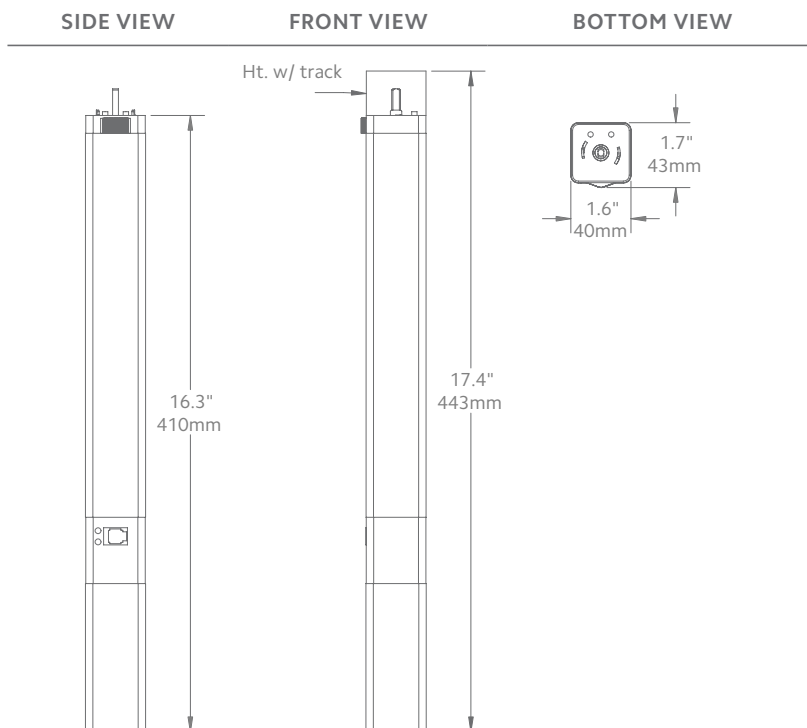

MOTORIZED TRACK FEATURES	AMP™ MOUNT
Power Supply	DC 16.5V=0.89A (100-240VAC 50/60Hz 0.5A)
Amperage	2.55Ah
Average Linear Speed	7.8 inches/sec
Power Consumption	40 watts
Torque	1.2Nm
Variable Speed	80, 100 & 120 rpm
Power Cable Length	6 feet
Certifications	UL/CE
Max Track Length	Estate™ – 16ft Architrac® 94001 – 40ft
Max. Load	64 lbs

Follow track specifications for drapery weight.

Architrac® & Estate™ Track Performance with AMP™ Motorization

DRAW	MIN. TRACK LENGTH	MAX. TRACK LENGTH	MAX. LBS. PER FOOT
ONE-WAY	18"	16'	4 LBS.
TWO-WAY	18"	16'	4 LBS.

Download the AMP™ APP to get started





Kirsch[®] is proud to extend a 10 year warranty on all Kirsch[®] Drapery Hardware products manufactured after July 1, 2018 using all Kirsch[®] components. This is part of our commitment to providing the highest quality products, which has been our continued tradition since 1907.

COVERED

by a 10 year warranty

- Kirsch[®] Drapery Hardware products are covered for defects in materials, workmanship or failure to operate for as long as the original retail purchaser owns the products (unless shorter periods are provided below).
- All internal mechanisms.
- Components and brackets.
- Operational cords for a full 7 years from the date of purchase.
- Repairs and/or replacements will be made with like or similar parts or products.
- Kirsch[®] motorization components are covered for 5 years from the date of purchase.

NOT COVERED

by a 10 year warranty

- Any conditions caused by normal wear and tear.
- Abuse, accidents, misuse or alterations to the product.
- Exposure to the elements (sun damage, wind, water/moisture, salt air) and discoloration or fading over time.
- Failure to follow our instructions with respect to measurement, proper installation, cleaning or maintenance.
- Shipping charges, cost of removal and reinstallation.

Kirsch[®] (or its licensed fabricators/distributor) will repair or replace the product or components found to be defective.

TO OBTAIN WARRANTY SERVICE

- Contact your original dealer (place of purchase) for warranty assistance.
- Contact Kirsch[®] at (800) 252-2512 for technical support, certain parts free of charge, for assistance in obtaining warranty service or for further explanation of our warranty.

NOTE: In no event shall Kirsch[®] or its licensed fabricators/distributor be liable or responsible for incidental or consequential damages or for any other indirect damage, loss, cost or expense. Some states do not allow the exclusion or limitation of incidental or consequential damages, so the above exclusion or limitation may not apply to you. This warranty gives you specific legal rights, and you may also have other rights which vary from state to state.

Different warranty periods and terms apply for commercial products and applications.