



GP-1000 Berm Flamer
GPK-1054 Berm Flamer Kit
GP-020 Alley Flamer Attachment



Assembly and Operating Instructions

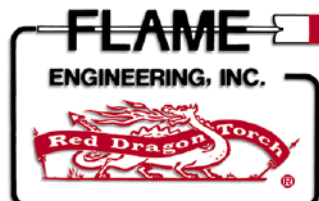

Table Of Contents	
Assembly Instructions	2-7
Start-up, Lighting and Operating Instructions	8
Check List for Daily Start Up and Warnings	9
Proper Purging Of LP-Gas Container	10
Vacuum Pre-Purged Domestic Tanks	11
Questions and Trouble Shooting	12

Background Information

Grapevine berm flaming is an excellent method of weed management. The first recorded flaming of grapevine berms occurred in Michigan in 1963 (NGPA 35), which also included a study of flaming blueberries and strawberries. The GP 750 and GP 1000 were originally designed for flaming grapevine berms but have been adapted for use in fruit and nut orchards. The flaming of grapevine berms helps to remove weeds and debris, thus reducing insect habitat and breeding grounds, which in turn lowers insect populations. The alley attachment is an option which allows one pass control of weeds on the berms and in the alley. As with all forms of agricultural flaming, grapevine berm flamers reduce herbicide use and operating costs.

Practices and Techniques

Flaming of grapevine berms can be done on a year-round basis. In the summer it is used approximately every two weeks and in the winter a pass will remove plant residues. The burners are set so that weeds in the row and on the side of the grapevine berms are flamed. In an orchard setting, the burners are set to control the weeds and grasses that grow under the tree canopy and between the trees. Ground speed will vary with weed pressure and gas pressure with an average speed of 3 miles per hour at 45 psi, producers can expect to use 11 to 21 gallons of fuel an hour. With the alley attachment, fuel consumption will double.

The GP 750 and the GP 1000 are an economical and effective method of weed control. In addition to saving growers' money and labor, the flamers reduce environmental damage from herbicide and pesticide use.

GP-1000 Trailer Assembly – for GPK-1054 Kits, Start at Mast Assembly Instructions

1. Slide axle into frame.
2. Loctite (or similar locking compound) set-screw into divot hole on axle – tighten securely. Tighten second setscrew directly into axle (no divot hole). See picture 1.
3. Slide hubs onto axle, making sure hub is securely against flange.
4. Place washer on and tighten axle nut and secure with cotter pin (be sure hub spins freely). See picture 2.
5. Tap dust cap onto end of hub.
6. Place tires onto hubs with valve stems to the outside and bolt.
7. Bolt on trailer jack using 3/8" x 1" bolts with flat washers on top and bottom, lock washers and nuts. See picture 3A.
8. Using retaining pin, secure base to bottom of stand. See picture 3B.
9. Bolt on coupler with 3/8" x 3" bolts using flat washers on top and bottom, lock washers and nuts. See picture 4A.

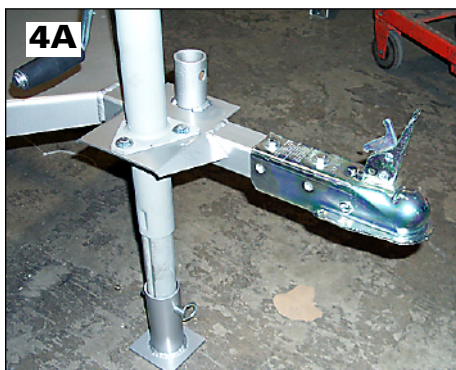
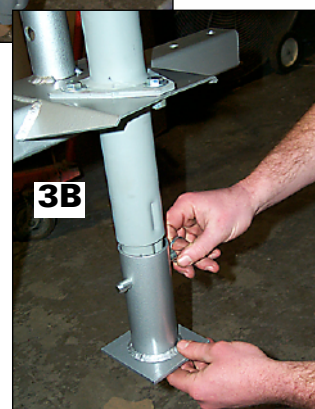
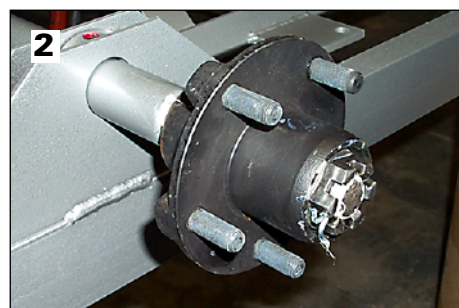
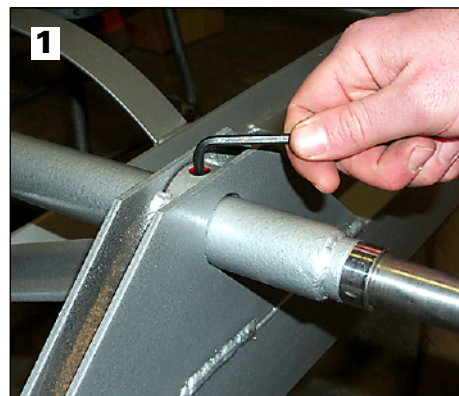

GP-1000 Tank Installation – for GPK-1054 Kits, Start at Mast Assembly Instructions

Note: Use only a New Tank equipped with a top mounted Liquid Withdrawal Valve and a top mounted Vapor Withdrawal Valve.

1. Connect valve guards with connecting bars using 3/8" x 2" bolts, lock-washers and nuts.
2. Place tank on the tank cradle bars on the trailer making sure the tank is in front of the alley attachment receiver bar. (Photo 1)
3. Place the valve guard on the top of the tank in line with the cable holes on the tank cradle (photo 1)
4. Place cable tension bolts through the cable holes on one side of the tank cradle (photo 2) and feed the cables through the cable brackets on the valve guards (photo 3) and through the cable hole on the opposite side of the tank cradle. Pull the cable hand tight and secure with cable clips (photo 4). Tighten tension bolts on other side until tank is secure (photo 2).

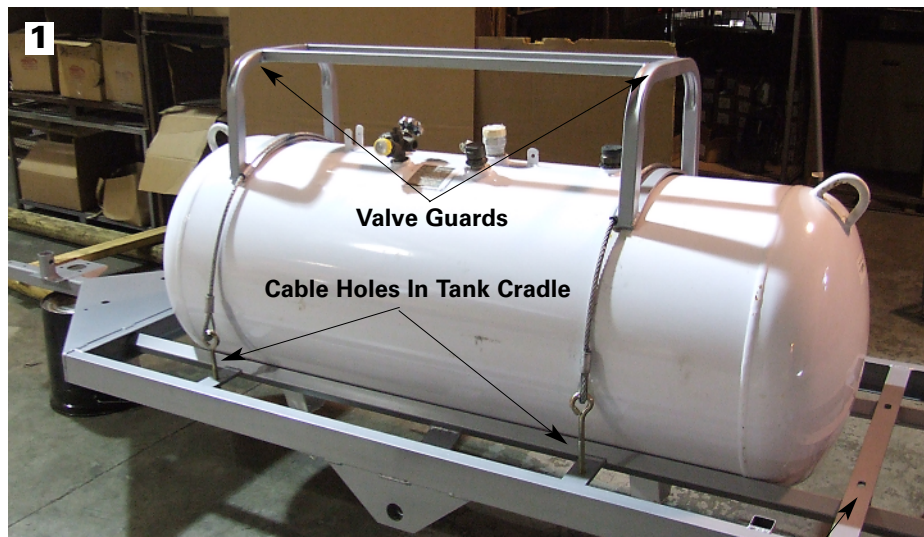

Alley Attachment Receiver Bar

GP-1000 and GPK-1054 Kit – Mast Assembly

Use thread sealant or Teflon® tape on all non-flared fittings

(Refer to picture 1 for steps 1 through 3)

1. Assemble brass tee (1A) onto bottom of nipple bracket (1B).
2. Assemble left and right solenoid/by-pass assemblies (1C) into right and left tee outlets – assemble so that the U-shaped hoses will face forward.
3. Assemble control head (1D) (regulator and gauge control assembly) to top of nipple – assemble so top elbow points toward the rear of unit.

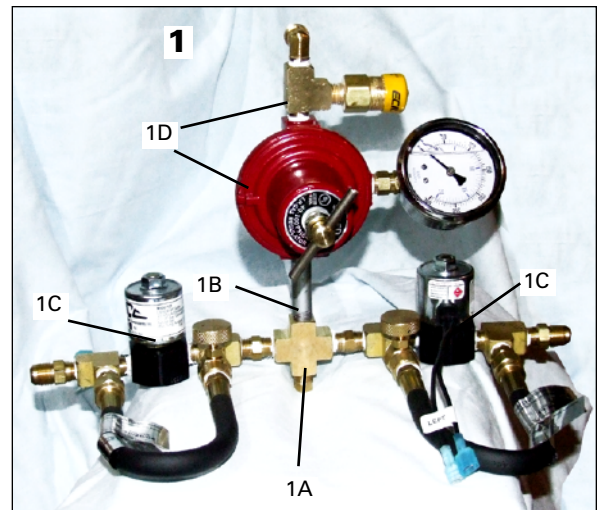

(Refer to picture 2 for steps 4 through 6)

4. Assemble mast onto trailer using 3/8" x 1" bolts with flat washers on top and bottom and a lock-washer and nut on bottom.
5. Insert 3/4" x 5" bolt, one nut on top of mast and one nut under the trailer. The boom arms will rest on the bolt. Boom arm height will be adjusted by running the bolt up or down.
6. Bolt mast brace on to the trailer (use 3/8" x 3" bolt, flat washers top and bottom and lock-washer with nut on bottom). Bolt mast brace to mast (use 3/8" x 1" bolt, flat washers on both sides and lock washer and nut on mast brace side).
7. Attach the nipple bracket of the control assembly to the mast using the 5/16" x 1" bolt. The regulator will be at the top. See picture 3.
8. Assemble strainer, solenoid and hose to tank.
9. Tighten hose into elbow on the regulator. See picture 3.

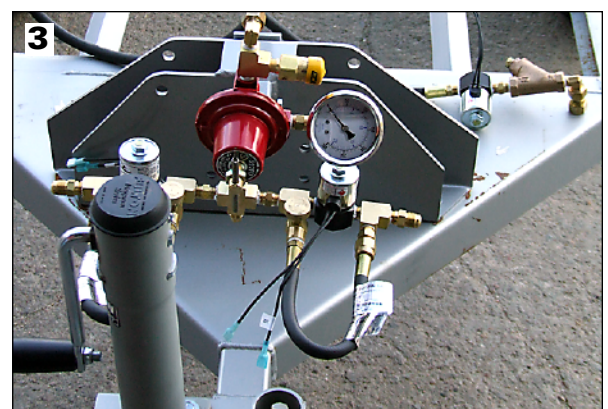
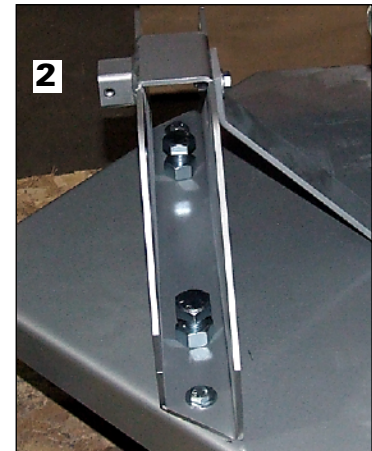

GP-1000 and GPK-1054 Kit – Boom Arm and Torch Assembly

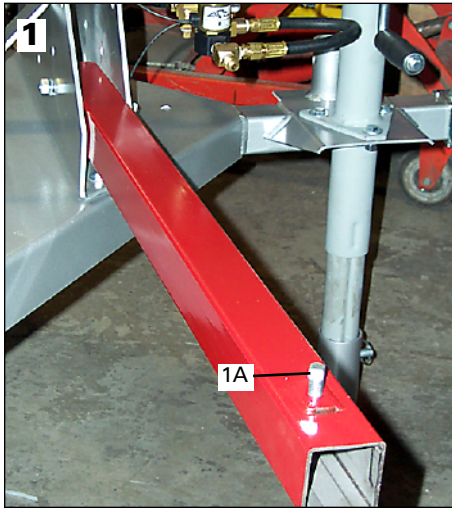

1. Bolt arms onto mast with 7/16" x 3" bolt, lock-nut. Make sure set screws (1A) are facing up.
2. Slide square tubing (mark L & R) into the corresponding arms with the spring pin (2A) towards the back and tighten the set screw (2B). See picture 2.
3. Assemble torch bar with spring hinge pin (3A) toward the front and secure with 3/8" x 3" bolt and lock nut. See picture 3.
4. Place springs on top and bottom set of pins on each arm and secure with 5/16" retainer caps. See picture 4.
5. Adjust arms to desired height with the 3/4" x 5" bolt in the mast.

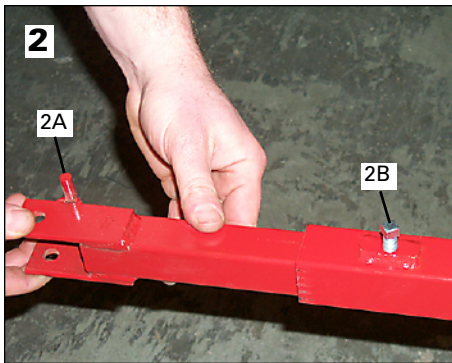

6. Place torches onto torch bars. Adjust to the desired angle and tighten the set-screws. See picture 5.
7. Attach 5' hoses with tees and 1' hoses to solenoid/by-passes. Attach 1' hoses coming off the tee to nipples (5A) on torches. See picture 5.

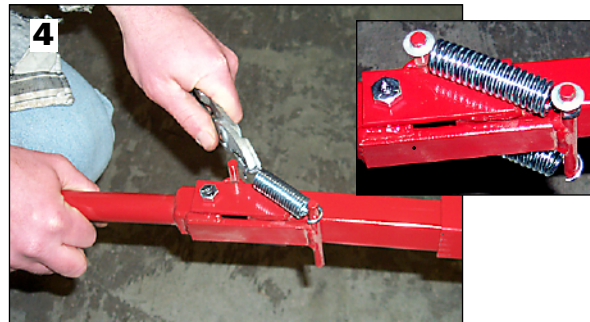
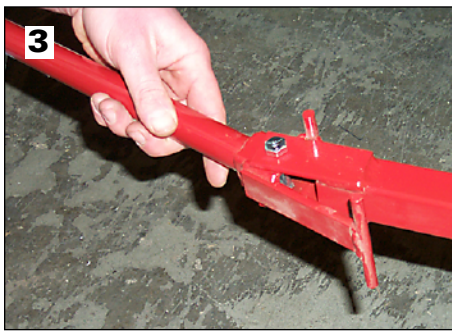

8. Lift the boom arms up and insert the two 1/2" retaining pins through the holes (5B) in the top of the mast to hold the boom vertically when transporting.

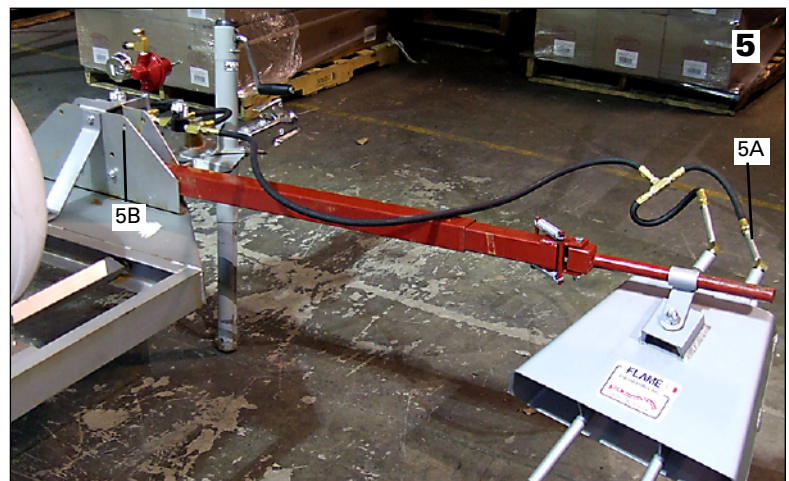

GP-020 Alley Attachment Assembly Instructions (Optional)

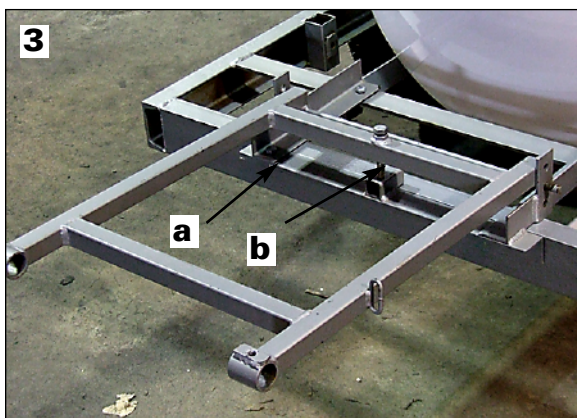
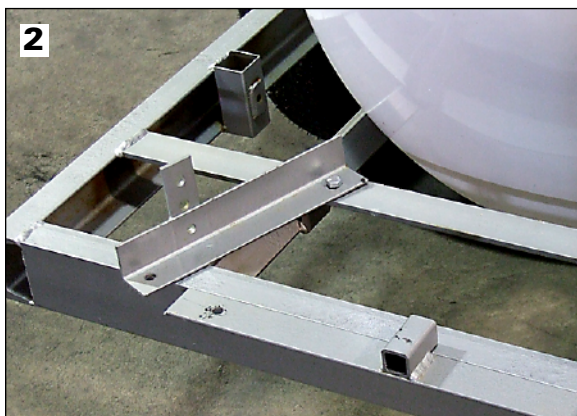
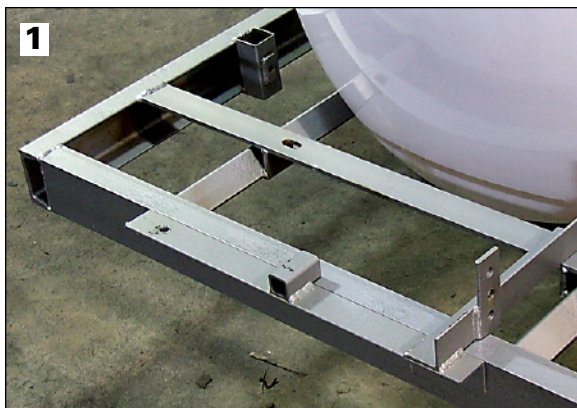

1. Bolt L-shaped bracket onto trailer.(See picture 1)
2. Bolt straight angle iron onto opposite side of trailer (leave loose). (See picture 2)
3. Put pins from torch bar holder into holes on brackets. (See picture 3)
4. Bolt straight angle iron onto L-shaped bracket. (See picture 3 arrow a)
5. Slide torch bar into holder and center. Then tighten set screws. (See picture 4 & 4b)
6. Adjust 7/16 x 2 1/2" bolt in center of torch bar holder to desired height. (See picture 3 arrow b)
7. Position torches on torch bar as needed. (See picture 5)

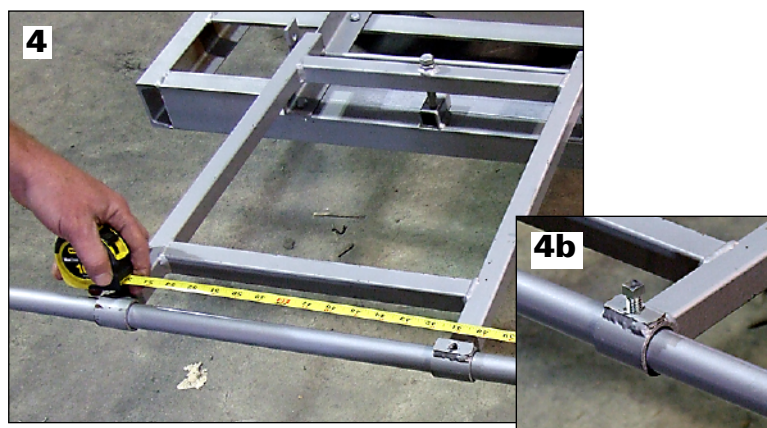

GP-020 Alley Attachment Assembly Instructions (Optional)

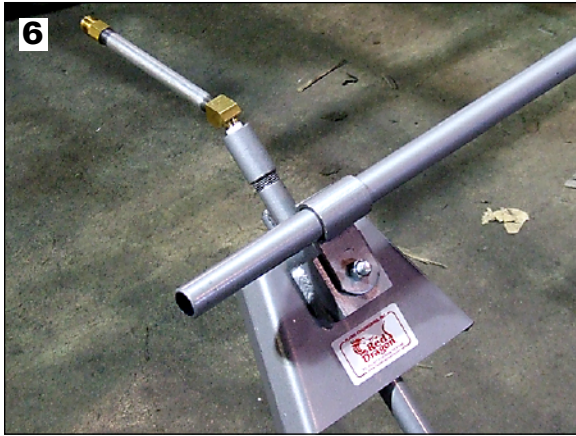

8. Tighten a nipple and brass flared fitting to each torch.
(See picture 6)

9. Connect 1/2" Tee to tank. (See picture 7)

10. Assemble control bracket (1" tubing) on to back of trailer.
(See picture 8)

11. Place controls into control bracket and tighten with 5/16 bolt.
(See picture 9)

12. Connect 5' hose from 1/2" Tee to the controls. (See picture 10)

13. Connect hose assembly to the bottom of the control.
(See picture 11)

14. Connect 1' hoses to fittings on torches. (See picture 12)

15. Connect alligator clips to battery. Connect short set of wires to solenoid by the tank. Connect longer set of wires to control solenoid.

16. Test for leaks throughout system.

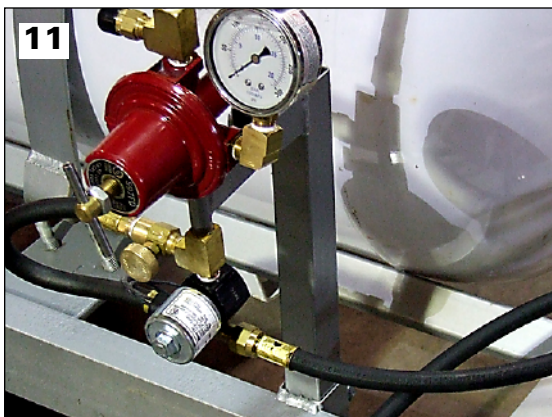
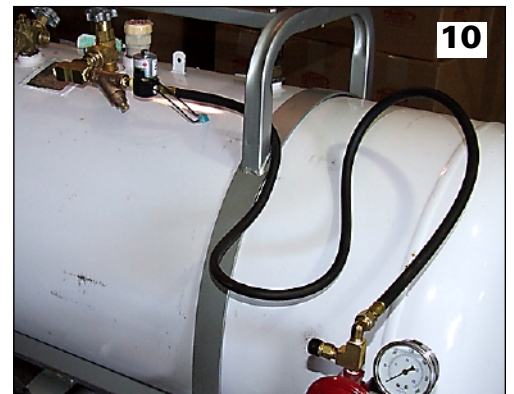
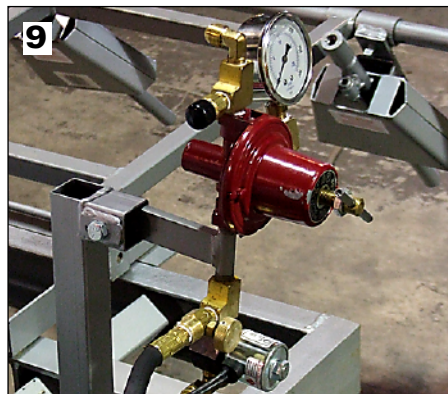
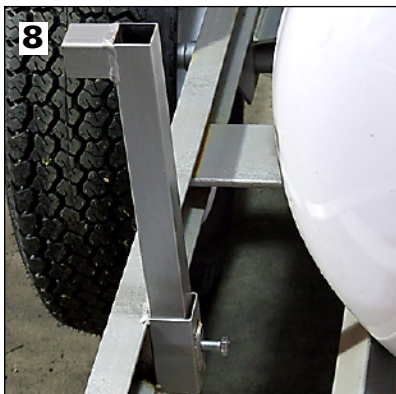
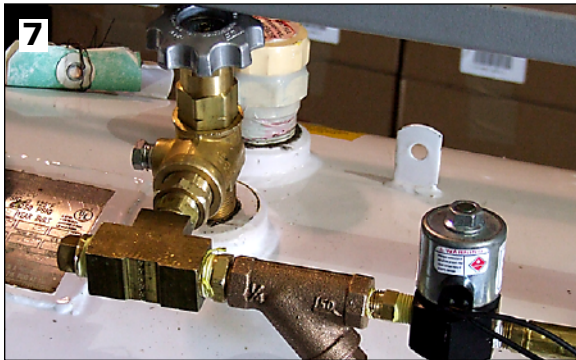

Start-up Procedure:

Note: Burp your Gauges. On the top of the pressure gauges, there is a little tab. At start-up, pull this tab up for a few seconds and then push it back in.

Step 1: Turn off all valves prior to lighting torches.

Step 2: Turn on tank valve slowly, press red master switch on & leak test all connections from the tank to the pilot bypass needle valves using soapy water or leak detector on every connection. If leaks are found, turn off tank valve and open the needle valve allowing the lines to bleed. Fix all leaks and start over from step 1 until no leaks are found.

Step 3: Following the Lighting Procedures below, light the right side torch and leak check all connections from the right pilot bypass needle valve to the torch using soapy water or leak detector on every connection. If leaks are found, turn off tank valve and allow lines to burn out. Repeat process until no leaks are found on the right side. Repeat this procedure for the left side until no leaks are found.

SEE WARNINGS AND CHECK LIST FOR DAILY START UP ON THE FOLLOWING PAGE.

Lighting Procedure:

Turn on tank valve master switch to on position. Adjust main regulator to 45-65 psi. Open pilot needle valves to light each torch one side at a time. Adjust pilots so that torches remain lit in wind. Turn on green full flame switch and verify working pressure of 45-65 psi.

Shut-Down Procedure:

Shut down by first turning the tank valve off. Then allow the gas in the system to burn out and turn the pilot valves off. Place the rocker switches on the control box in the off position.

Operating Tips:

For best results, flame when there is little or no wind, and when weeds and grasses are just emerging. Tall weeds and grasses may develop more extensive tap roots which are more difficult to control. Persistent weeds may require repeat applications, but most undesirable growth can be controlled by flaming.

To check the effectiveness of flaming, press weed leaf between thumb and forefinger. If a finger print appears, you have ruptured plant cells which generally indicates a good kill on weeds. Within minutes you'll see signs of stress, but on cool, cloudy days it may take a day or two to see the results of the flaming.

When stopping or turning you may switch to the pilot setting and resume full flame when returning through the alley.

Each torch is adjustable. It is best to adjust after sundown in low light so you can see the flame pattern.

Check List for Daily Start Up and Warnings

WARNING!

**Use Extreme Caution — flames from this unit can cause serious injury or death.
Do Not Operate this unit when leaks are present. Operate only in well ventilated areas.**

1. Fuel Tank Valve OFF
2. Pilot Valve(s) OFF
3. Regulator(s) OFF
4. Control Switch OFF

LEAK TEST

5. Fuel Tank Valve ON
CHECK FOR LEAKS FROM FUEL TANK TO SOLENOID
6. Press Red Master Switch On
7. Adjust Regulator(s) to 45-65 PSI
8. Pilot Valve OPEN
9. Light All Torches
Check All Connections and Components for Leaks.
Correct Leaks.
10. Adjust Main Line Regulator to Working Pressure Desired
11. Move control toggle switches to ON
12. Check for Leaks Throughout System
13. Correct ALL Leaks Malfunctioning Equipment
14. Cycle Control Switch Several Times
15. Fuel Tank Valve to OFF
16. Move Control Switch to OFF
17. Allow ALL Fuel to Burn Out of Lines and Controls when shutting down.

WARNING

**Use Extreme Caution - Do Not Operate this unit when leaks are present.
Use only in well ventilated areas. Do Not Operate this unit when any flammables are present.**

Flames produced by this unit can reach 2,000° and could cause serious burns and possibly death.

Proper Purging Of LP-Gas Container

The Importance of Purging

A very important step which must not be overlooked by LP-Gas distributors is the importance of properly purging new LP-Gas containers. Attention to this important procedure will promote customer satisfaction and greatly reduce service calls on new installations. Consider the following:

- Both ASME and DOT specifications require hydrostatic testing of vessels after fabrication. This is usually done with water.
- Before charging with propane, the vessel will contain the normal amount of air.

Both Water and Air are Contaminants

They seriously interfere with proper operation of the system and the connected appliances. If not removed, they will result in costly service calls and needless expense far exceeding the nominal cost of proper purging.

Neutralizing Moisture

Even if a careful inspection (using a pen flashlight) reveals no visible moisture, the container must still be neutralized, since dew may have formed on the walls; additionally, the contained air may have relative humidity up to 100%.

IMPORTANT - If a tank is allowed to run completely out, alcohol must be added when refilled. Propane is -44° F. If the ambient air temperature is higher, there will be a thermal transfer of latent heat, hot to cold, until the temperature equalizes. This will cause icing in the system if not neutralized with methanol.

A rule of thumb for neutralizing moisture in an ASME container calls for at least 1 pint of genuine absolute anhydrous methanol* (99.85% pure) for each 100 gallons of water capacity of the container. On this basis, the minimum volumes (US measurements) for typical containers would be as shown to the right:

Container Type	Minimum Volume Methanol Required
100 LB ICC Cylinder	1/8 pt. (2 fl. oz.)
500 gal. tank	5 pts. (2-1/2 qts.)
1000 gal. tank	10 pts. (1-1/4 gal.)
2000 gal. tank	20 pts. (2-1/2 gal.)

IMPORTANT - Avoid substitutes - they will not work. The secret of the effectiveness of methanol over all other alcohols is its high affinity for water plus a boiling point lower than all other alcohols, and most important: a boiling point lower than water.

The Importance of Purging Air

If the natural volume of atmosphere in the vessel is not removed before the first fill, these problems will result:

- Installations made in the spring and summer will experience excessive and false container pressures. This will cause the safety relief valve to open, blowing off the excess pressure.
- The air mixture present in the vapor space will be carried to the appliances. This may result in as many as 5 or more service calls from pilot light extinguishment.
- If a vapor return equalizing hose is not used, the contained air will be compressed above the liquid level, resulting in slow filling.
- If a vapor equalizing hose is used, the air and any moisture it contains, will be transferred from the storage tank to transport.

Additionally, if atmospheric air is properly purged from the storage tank;

- transfer will be faster,
- the pump will not stall,
- less energy will be required to fill the container.

Never Purge With Liquid

The wrong way of course is the easiest way. Never purge a container with liquid propane. To do so causes the liquid to flash into vapor, chilling the container, and condensing any moisture vapor on the walls where it remains while the pressure is being blown down. Additionally, less than 50% or as little as 25% of the air will be removed by this easy but wrong method.

Vacuum Pre-Purged Domestic Tanks

Read This Before Initial LP-Gas Filling of a Vacuum Pre-Purged Domestic Tank

This new container has been vacuum purged of air in accordance with the NPGA Safety Bulletin #133-89 (a). The service valve, vapor return valve and the fill valve have been equipped with tamper evident seals to indicate if the valve(s) have been opened. If the tamper evident seals have been violated, THE CONTAINER MUST BE REPURGED in accordance with NPGA Safety Bulletin #133-89 (a). (see proper purging on page 9)

Failure to properly purge a container can result in increased pressure, improper burning fuel mixture and odorant fade. Any of these conditions can result in personal injury, property damage or death.

Vacuum Verification Process:

To verify that a vacuum is present, remove the plastic wrap from the service valve, verify that the service valve hand wheel is close. Connect a vacuum pressure gauge to the service valve outlet connection and open the hand wheel. Visually check the vacuum pressure gauge dial for the presence of a vacuum. Close the service valve and disconnect the vacuum gauge. if the vacuum is not in accordance with NPGA Safety Bulletin #133-89 (a), THE CONTAINER MUST BE REPURGED.

Methanol Injection Process:

Inject methanol into the container through the service valve (before filling the container with LP-Gas) using the service valve outlet connection. Attach the POL connection to the service outlet connection. The POL connection should have a low pressure rubber hose extend into a container of methanol.

Slowly open the service valve to allow the vacuum in the vessel to pull the methanol into the vessel. The container of methanol should not be allowed to run dry and pull air into the vessel.

- The presence of a vacuum in the container does not eliminate the need for the introduction of methanol into the container.
- The rule of thumb for neutralizing moisture in an ASME container is to introduce at least one pint of genuine absolute anhydrous methanol (99.85% pure) for each 100 gallon of water capacity of the container. (see chart on page 9)

LP-Gas Injection Process:

After the completion of the methanol injection process, connect a hose from a source of LPG to the POL connection of the service valve. This hose can be used to inject either liquid or vapor product into the vessel. The appropriate amount of LPG to neutralize the vacuum pressure in the container will vary depending on the volume of the vessel. If liquid is used, 1 to 4 gallons of LPG is required for all vessels up to 1000 wg. If vapor is used, wait until there is no longer an audible transfer of vapor from the source of the LPG to the vessel.

Filling Process:

After the completion of the LP-Gas injection process, close the service valve and disconnect the POL connection. Remove the plastic wrap from the filler connection, remove the yellow cap and connect your filler hose to the vessel and proceed to fill in the normal manner.

Questions & Trouble Shooting

Installation Problems:

If you have problems, questions, or feel you are missing a part during installation, please call Flame Engineering toll free at 1-800-255-2469 and our trained staff will gladly help you.

Operation Problems:

If you have problems during operation, please check the following trouble shooting guidelines first. If you use this guide and still have problems call Flame Engineering and our staff will try to help remedy the situation.

Trouble Shooting Tips (Read This First Before Calling the Factory)

START WITH A CLEAN NEW TANK (We recommend only new tanks)

Always begin with a new properly prepped and purged, liquid tank, capable of delivering liquid to the torches. The liquid withdrawal must be from the top of the tank. DO NOT use a vapor withdrawal tank. Always perform the **Methanol Injection Process**, as described in this manual, before filling the tank with LP-Gas. Use only clean fuel to avoid line/torch blockage.

IF YOU EXPERIENCE FLAME OUT

Check the fuel strainer if you are experiencing flame out. Close tank valve. Clean accordingly. If tank debris is found in strainer or torches shortly after use, begin again with a clean, new purged tank. (See Your LP-Gas Dealer) Did you perform the Methanol Injection Process before filling the tank with LP-Gas?

IF YOU ARE GETTING A LOW FLAME

Check torch orifices for blockage. Clean thoroughly if necessary. Did you perform the Methanol Injection Process before filling the tank with LP-Gas?

IF NO FUEL IS GETTING THROUGH TO THE TORCHES

Check electrical connections to the solenoids and make certain all valves are free and clear of tank debris. Did you perform the Methanol Injection Process before filling the tank with LP-Gas?

