



## GF-2011 Multi-purpose Flamer

### Assembly and Operating Instructions

**Please Read All Instructions and Save These Instructions For Future Reference.**

- This device is intended for outdoor use only.
- This unit is designed for a vapor-withdrawal LP-Gas cylinder only.

### IMPORTANT WARNINGS:

#### DO NOT OPERATE THIS EQUIPMENT IF:

- You are subject to seizures, loss of consciousness, or fainting.
- You have been drinking alcohol, using illicit drugs, or prescription drugs that might effect your judgment or balance.
- You have not read or do not understand the operator's manual.
- You are not capable of safely operating this type of equipment.

#### DO NOT ALLOW CHILDREN TO OPERATE THIS EQUIPMENT.

#### FOR YOUR SAFETY!

If You Smell Gas:

1. Shut off gas to the device.
2. Extinguish any open flame.
3. Check the device for leaks using soapy water.
4. DO NOT attempt to relight the device until leaks are repaired and there is no gas smell.

DO NOT use this device in areas where gasoline or other liquids having flammable vapor are stored or used.



**FLAME ENGINEERING, INC.**  
PO Box 577 • 230 West Hwy 4 • LaCrosse, KS 67548  
800-255-2469 • 785-222-2873 • Fax 785-222-3619  
[www.FlameEngineering.com](http://www.FlameEngineering.com)

## This kit includes:

1. 1 x Handle
2. 1 x Regulator Assembly
  - 2A 1 x P-3200W\* (POL)
  - 2B 1 x 567RC (0-60 PSI Regulator)
  - 2C 1 x G-25\* (Liquid Pressure Gauge)
  - 2D 1 x HP48HG (4' Rubber LPG Hose)
  - 2E 1 x V-334\* (Flame Adjusting Needle Valve)
  - 2F 1 x F-422\* (1/4" Female Elbow)
  - 2G 1 x 101-SPA-Nipbrkt (SPA & RD Bracket)
  - 2H 1 x F-428\*(1/4" Female x 3/8" Male Flare Elbow)
3. 1 x HP65T (65" Hose)
4. 1 x Main Frame
5. 1 x Heat Shield
6. 2 x Axle
7. 1 x Axle Stabilizer Sleeve
8. 2 x GFW-24 (24" Diameter Wheel (3/4" Axle))
9. 1 x Rest Stand
10. 1 x Manifold T Support
11. 1 x Torch Manifold
  - 11A 5 x VT21/2-0 (Vapor Torch)
12. 1 x GF-2011 Hardware Packet
  - 12A 2 x Torch Manifold Mounting Bracket
  - 12B 4 x 100-120-034 (3/4" round locking collar)
  - 12C 1 x 100-303-062P (Tank Strap)
  - 12D 1 x 100-405-002 (5/32 allen wrench)
  - 12E 4 x 1/4" nut
  - 12F 4 x 1/4" lock washer
  - 12G 4 x 1/4" x 3/4" slotted bolt
  - 12H 5 x 3/8" x 1/2" bolt
  - 12I 1 x Manifold Nipple Assembly
13. 1 x GF-2011 Instruction Packet

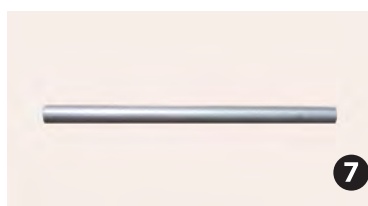
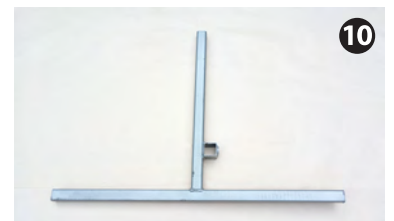
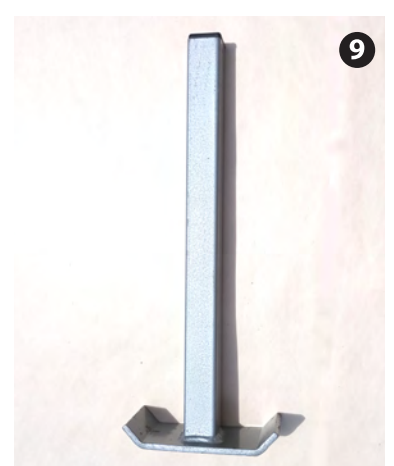

## GF-2011 Assembly Instructions.

1. Insert one Axle (#6) through right or left side of Main Frame (#4). The Axle will then go through Axle Stabilizer Sleeve (#7). **See picture 1.** If using two Axles, you will want 15 7/8" of Axle sticking out on each end. You may need to use a rubber mallet for light tapping to insert Axles. Once Axle is through you can tighten set screws with 5/32" Allen Wrench (#12D).
2. Repeat step 1 if using both Axles. **See picture 2.**
3. Slide one 3/4" Lock Collar (#12B) over both right and left Axle. **See picture 3.** Do not tighten Lock Collars at this time.
4. Slide 24" Wheel (#8) onto both right and left Axle. **See picture 4.**
5. Slide one 3/4" Lock Collar (#12B) onto both right and left side Axles. Line up with small, drilled depression in Axle and tighten set screws with 5/32" Allen Wrench. **See picture 5.**
6. Move right and left Locking Collars (#12B) on other side of Wheel's snug against Wheel and tighten set screws with 5/32" Allen Wrench. **See picture 6.**
7. Slide Manifold T Support (#10) into Main Frame (#4) and tighten with one 3/8" x 1/2" bolt. **See picture 7.**
8. Insert Rest Stand (#9) into Manifold T Support (#10) and tighten with one 3/8" x 1/2" bolt. **See picture 8.**
9. Attach Heat Shield (#5) to Main Frame (#4) with four 1/4" x 3/4" slotted bolts and tighten other side down with four 1/4" lock washer and nut. **See pictures 9 and 10.**
10. Attach one Torch Manifold Mounting Bracket (#12A) onto left side of Manifold T Support (#10) and tighten with one 3/8" x 1/2" bolt. **See picture 11.**
11. Insert Torch Manifold (#11) through left Torch Manifold Mounting Bracket (#12A). **See picture 12.**
12. Repeat steps 10 and 11 for right side and you will then set angle on Torch Manifold to 45° or the desired angle and tighten both supplied set screws with 5/32" Allen Wrench. **See picture 13.**

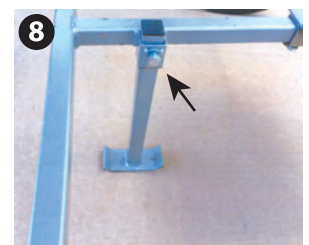
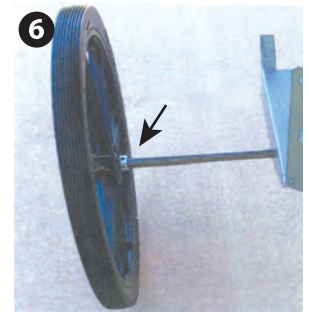
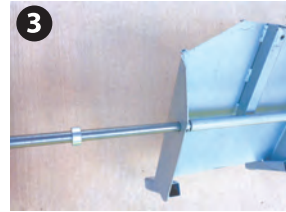
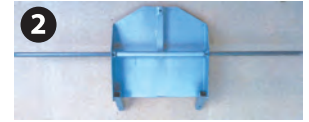
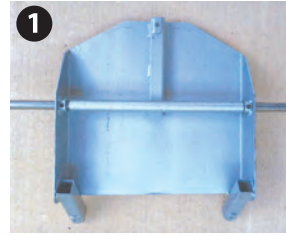

13. Insert Manifold Nipple Assembly (#12l) to Torch Manifold (#11) leaving nipple facing upper right or left side of Tank Heat Shield. **See picture 14.**



14. Insert HP65T (#3) hose through upper right or left hole that is on Tank Heat Shield and tighten into Manifold Nipple Assembly (#12l). **See pictures 15 and 16.**

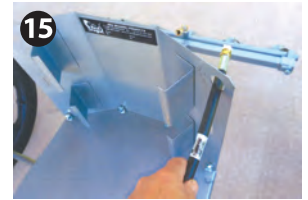

15. Insert Handle (#1) through right or left side of square tubing on Main Frame (#4) and tighten with 3/8" x 1/2" bolt. (Handle can be positioned so the operator can walk beside the vegetable bed on the right or left side, or the handle can be positioned so the operator can walk directly behind the flamer for areas like walkways or driveways.) **See pictures 17 and 18.**

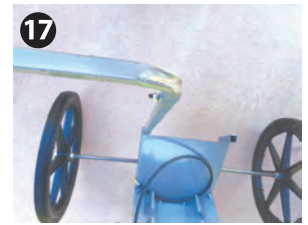

16. Mount Regulator Assembly (#2) with 5/16" lock washer nut onto bolt on handle. Attach and tighten loose end of HP65T (#3) to Flare fitting in Regulator Assembly. **See picture 19.**

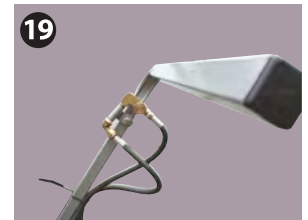

17. Set standard 20 lb. propane tank (Not included) onto Main Frame.



18. Run the Strap (#12C) through the slots on Heat Shield and around propane tank (Not included) and fasten to secure. **See picture 20.**

19. Attach the Regulator Assembly (#2) to propane tank using an open-end wrench or crescent wrench. This is going to be left-handed threads and needs to be tightened counterclockwise. Do not over tighten. **See picture 21.**

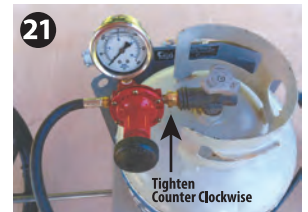

20. You are now ready to move on to lighting instructions.

## Connecting To The Supply Cylinder:

The propane supply cylinder used with this torch should be no less than 20 lb. capacity and must be designed, fabricated, tested and marked in accordance with regulations of the U.S. Department of Transportation, the Canadian Transport Commission or the Interstate Commerce Commission. Supply cylinders must be arranged to provide for vapor withdrawal from the operating cylinder.

1. Inspect the nut/nipple of the P.O.L. connection on the LP-Gas hose. Check for dents or physical damage. The O-ring should be present on nipple fitting. If damage is evident, call for replacement parts.
2. Be certain the supply cylinder valve is fully turned off. Remove the protective plastic plug from the cylinder valve outlet connection.
3. Connect the P.O.L. fitting to the propane supply cylinder by turning the left hand threaded P.O.L. nut counter clockwise into the cylinder valve outlet. Snug the connection tight with a wrench. DO NOT OVERTIGHTEN.

## Lighting Instructions:

### **IMPORTANT NOTE**

The P.O.L. contains an integral flow-check valve. Opening the LP-Gas cylinder valve rapidly can cause the valve to check. If the P.O.L. flow valve checks, close the LP-Gas cylinder valve, wait 10-15 seconds and slowly open the LP-Gas cylinder valve.

- If no leaks are found, proceed with lighting the torch.
- Always use a flint lighter to ignite the torch. DO NOT USE MATCHES OR CIGARETTE LIGHTER TO IGNITE THE TORCH.
- Be certain the flame adjusting valve is closed before opening the LP-Gas cylinder valve.

1. Slowly open the LP-Gas cylinder valve. Check all gas connections to the torches for leaks with a leak detection solution, such as soapy water. Leaks will be indicated by forming bubbles around the source. Please allow one minute for bubbles to appear. Repair all leaks and retest for leaks prior to lighting torches.
2. Open the flame adjusting needle valve 1/8 turn or until a small amount of gas is heard escaping. Using a flint lighter, ignite each torch. Do not place your hand or any part of your body in the path of the burners while lighting or operating the unit. DO NOT USE MATCHES OR CIGARETTE LIGHTER TO IGNITE THE TORCHES.
3. Adjust regulator to the desired pressure. Lower pressure settings conserve fuel. Use the lowest setting that will allow you an adequate rate of application.
4. Adjust the final size of the flames by using the flame adjusting needle valve.



### **FLAME ENGINEERING, INC.**

PO Box 577 • 230 West Hwy 4 • LaCrosse, KS 67548  
800-255-2469 • 785-222-2873 • Fax 785-222-3619  
[www.FlameEngineering.com](http://www.FlameEngineering.com)

## Operating Notes:

1. The torch manifold angle may be adjusted by loosening the collars (D) holding the manifold bar. The manifold may also be adjusted in or out from the unit by loosening the 3/8 x 1/2 bolt and sliding the tee bracket.
2. The wheel width may also be adjusted by loosening and moving the lock collars on the axle. The handle may also be assembled in a number of positions depending on which bracket you slide it into and which direction you point the "L" of the handle.
3. Recommended operating pressure is 20-25 PSI. The most efficient way is to light your torches at a low pressure and then dial the adjusting needle valve until you get a blue looking flame.
4. If flaming for an extended period, you may see the Propane tank frost up and your flame pressure drop. If this occurs, you will need to turn off your propane tank and let the tank defrost until using again. You can also have a spare tank on hand to switch out while another tank is thawing.

## To Shut Down:

1. Close the LP-Gas cylinder valve.
2. Allow the gas to burn out of hose. After the flame is no longer visible, turn the flame adjusting valve to the closed or "off" position. TO RESTART follow lighting instructions.

## Disconnecting From Supply Cylinder:

1. Be certain supply cylinder valve is turned off.
2. Disconnect the P.O.L. nut/nipple fitting on the LP hose from the propane supply.
3. Replace the protective plastic plug into the cylinder valve outlet.



### FLAME ENGINEERING, INC.

P.O. BOX 577 • 230 WEST Hwy 4 • LaCrosse, KS 67548  
800-255-2469 • 785-222-2873 • Fax 785-222-3619  
www.FlameEngineering.com

## Safety Check List:

- Gloves should be used at all times. Long sleeves, long pants & boots are recommended.
- Use only with cylinders equipped with vapor withdrawal valves.
- Secure cylinders in a level, upright position. Do not invert or lay cylinders on their sides.
- Do not apply flame to cylinders to check for leaks or to increase gas pressure.
- Keep torches, open flame and sources of ignition away from cylinders, regulators and hose.
- Do not operate torches or any equipment if the odor of LP-Gas is evident. Immediately shut off all valves and, using soapy water, check all equipment for leaks.
- Cylinder valves must be protected. Do not hoist a cylinder by the valve.
- Do not leave the unit unattended while in operation.
- This equipment is for outdoor use only with adequate ventilation.
- Have a type ABC fire extinguisher on the job site, easily accessible to the person operating the unit.

### WARNING:

Use extreme caution at all times. You are using an intense open flame. This torch produces an extremely hot and nearly invisible flame. Read and follow the Safety Check List and Daily Equipment Check List before attempting to operate this torch.

### CAUTION

- Propane is heavier than air which can cause it to accumulate in low areas. Be certain all areas are well ventilated.
- Propane has a distinct ODOR. If you smell it, IMMEDIATELY discontinue work, extinguish all flames, locate the leak and correct it, ventilate area before lighting torch.
- Use extreme caution at all times. This device has an intense open flame. Disregard of safe practices can result in severe fire damage, personal injury, or possible death.
- Never direct torch flame toward any person or animal.

**READ ALL INSTRUCTIONS & SAFETY PRECAUTIONS BEFORE OPERATING THIS MACHINE**

1. 1x Handle
2. 1 x Regulator Assembly
3. 1 x HP65T (65" Hose)
4. 1 x Main Frame
5. 1 x Tank Heat Shield
6. 2 x Axle
7. 1 x Axle Sleeve
8. 2 x GFW-24 (24" Diameter Wheel (3/4" Axle)
9. 1 x Rest Stand
10. 1 x Manifold T Support
11. 1 x Torch Manifold
- 12 A. 2 x Torch Manifold Mounting Bracket
- 12 B. 4 x 100-200-034P (3/4" Round Locking Collar)
- 12 I. 1 x Manifold Nipple Assembly

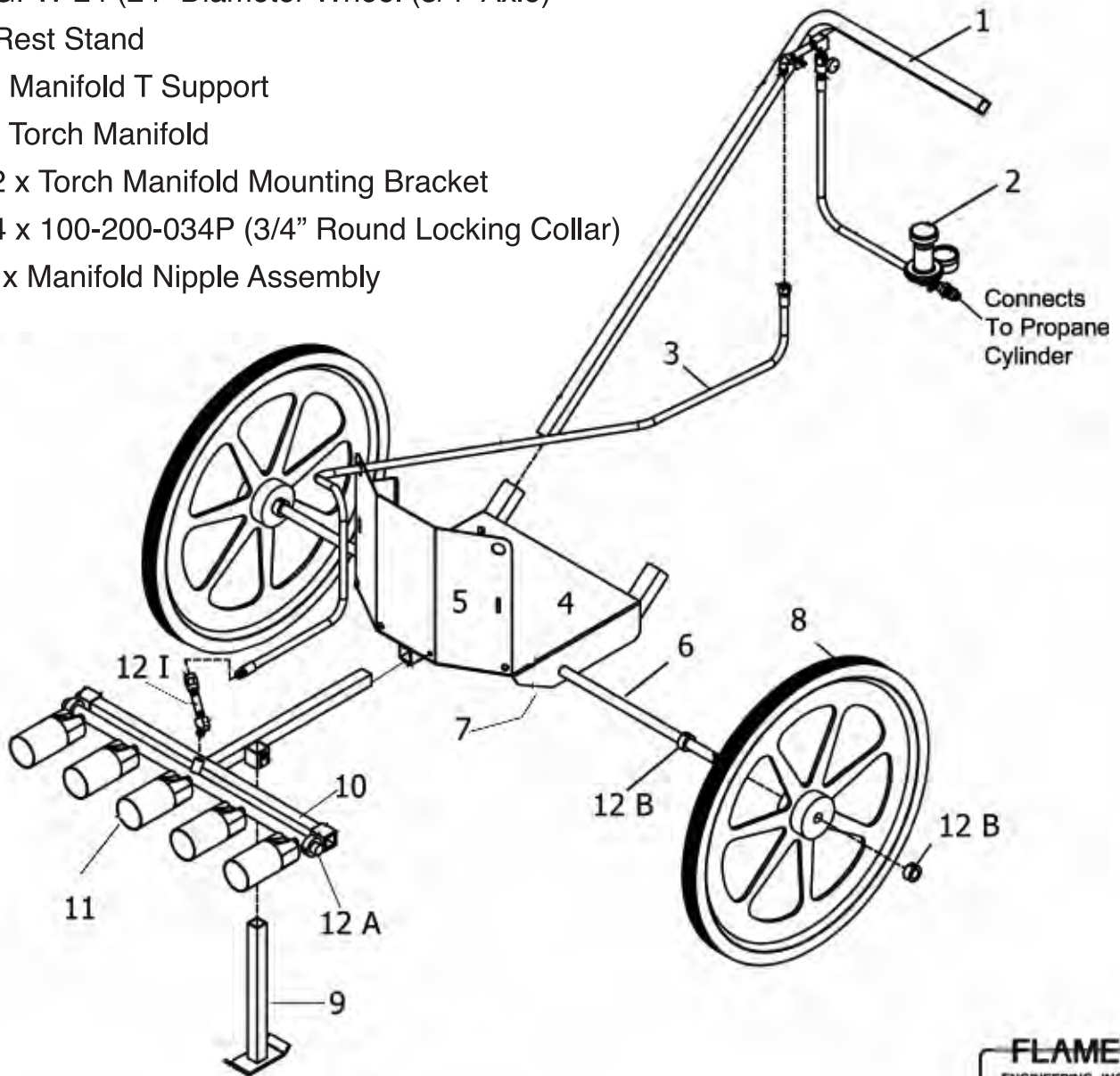

**NOTE: Where shaft collars are used to secure wheels or manifold, be sure set screws are installed to line up with small drilled depression in shaft.**



**FLAME ENGINEERING, INC.**  
PO Box 577 • 230 West Hwy 4 • LaCrosse, KS 67548  
800-255-2469 • 785-222-2873 • Fax 785-222-3619  
[www.FlameEngineering.com](http://www.FlameEngineering.com)