

Ford 5.0L Mustang GT Supercharger System Installation Instructions

2018-2020 Model Year*

*2018-2019 Model-Year 50 State Smog Legal Per CARB EO# D-213-38

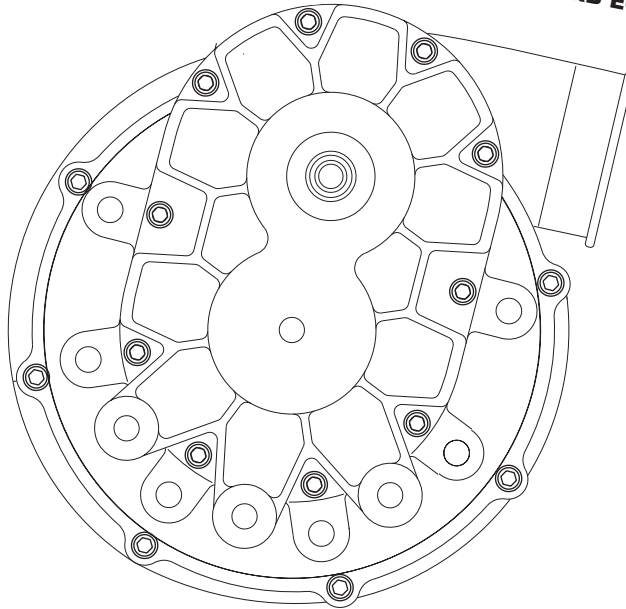

ENGINEERING, INC

1650 Pacific Avenue, Channel Islands, CA 93033-9901 • Phone (805) 247-0226
Fax: (805) 247-0669 • www.vortechsuperchargers.com • M-F 7:00 AM - 3:30 PM (PST)

FOREWORD

This manual provides information on the installation, maintenance and service of the Vortech supercharger kit expressly designed for this vehicle. All information, illustrations and specifications contained herein are based on the latest product information available at the time of this publication. Changes to the manual may be made at any time without notice. Contact Vortech Engineering for any additional information regarding this kit and any of these modifications at (805) 247-0226 7:00am-3:30pm PST.

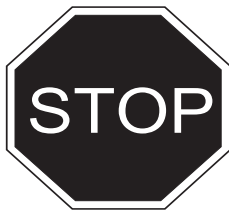

Take note of the following before proceeding:

1. Proper installation of this supercharger kit requires general automotive mechanic knowledge and experience. Please browse through each step of this instruction manual prior to beginning the installation to determine if you should refer the job to a professional installer/technician. Please contact your dealer or Vortech Engineering for possible installers in your area.
2. This product was designed for use on stock (un-modified, OEM) vehicles. The PCM (computer), engine, transmission, drive axle ratios and tire O.D. must be stock. If the vehicle or engine has been modified in any way, check with Vortech prior to installation and use of this product.
3. Use only premium grade fuel with a minimum of 91 octane (*R+M/2*).
4. Always listen for any sign of detonation (*knocking/pinging*) and discontinue hard use (*no boost*) until problem is resolved.
5. Vortech is not responsible for any clutch, transmission, drive-line or engine damage.

Exclusions from Vortech warranty coverage considerations include, but not limited to:

1. Neglect, abuse, lack of maintenance, abnormal operation or improper installation.
2. Continued operation with an impaired vehicle or sub-system.
3. The combined use of Vortech components with other modifications such as, but not limited to, exhaust headers, aftermarket camshafts, nitrous oxide, third party PCM programming or other such changes.

©2019 VORTECH ENGINEERING, INC

All rights reserved. No part of this publication may be reproduced, transmitted, transcribed, or translated into another language in any form, by any means without written permission of Vortech Engineering, Inc.

TABLE OF CONTENTS

FOREWORD	ii
TABLE OF CONTENTS	iii
IMPORTANT NOTES	iv
TOOL & SUPPLY REQUIREMENTS	v
PARTS LIST	vi
1. BASIC COMPONENT REMOVAL	1
2. SUPERCHARGER MOUNTING BRACKET INSTALLATION	11
3. ENGINE COOLING SYSTEM MODIFICATION	19
4. DISCHARGE TUBE ASSEMBLY & CHARGE AIR COOLER INSTALLATION	29
5. FUEL INJECTOR REPLACEMENT	45
6. FUEL PUMP BOOSTER INSTALLATION	51
7. PCV MODIFICATON & AIR INLET ASSEMBLY INSTALLATION	57
8. EMISSIONS LABEL INSTALLATION	63
9. REFLASH COMPUTER	65
10. FINAL CHECK	67
APPENDIX A - DIAGRAM, ASSEMBLY, SUPERCHARGER MOUNTING BRACKET	69
APPENDIX B - DIAGRAM, HARDWARE, SUPERCHARGER MOUNTING BRACKET	70
APPENDIX C - DIAGRAM, BELT ROUTING	71

NOTICE

This product is protected by state common law, copyright and/or patent. All legal rights therein are reserved. The design, layout, dimensions, geometry, and engineering features shown in this product are the exclusive property of Vortech Engineering, Inc. This product may not be copied or duplicated in whole or part, abstractly or fundamentally, intentionally or fortuitously, nor shall any design, dimension, or other information be incorporated into any product or apparatus without prior written consent of Vortech Engineering, Inc.

2018-2020 FORD MUSTANG GT

Installation Instructions

Congratulations on selecting the best performing and best backed automotive supercharger available today... the VORTECH® supercharger!

Before beginning this installation, please read through this entire instruction booklet and the Street Supercharger System Owner's Manual which includes the Limited Warranty Program, the Warranty Registration form and return envelope.

Vortech supercharger systems are performance improving devices. In most cases, increases in torque of 30-35% and horsepower between 35-45% can be expected with the boost levels specified by Vortech Engineering. This product is intended for use on healthy, well maintained engines. Installation on a worn-out or damaged engine is not recommended and may result in failure of the engine as well as the supercharger. Vortech Engineering is not responsible for engine damage.

Installation on new vehicles will not harm or adversely affect the break-in period so long as factory break-in procedures are followed.

For best performance and continued durability, please take note of the following key points:

1. Use only premium grade fuel 91 octane or higher (R+M/2).
2. The engine must have stock compression ratio.
3. If the engine has been modified in any way, check with Vortech prior to using this product.
4. Always listen for any sign of detonation (pinging) and discontinue hard use (no boost) until problem is resolved.
5. Before beginning installation, replace all spark plugs that are older than 1-year or 15,000 miles with original heat range plugs as specified by the manufacturer and reset timing to factory specifications (follow the procedures indicated within the factory repair manual and/or as indicated on the factory underhood emissions tag). Do not use platinum spark plugs unless they are original equipment. Change spark plugs every 20,000 miles.
6. **Oil-Fed Units Only:** Perform an oil & filter change upon completion of this installation & prior to test driving your vehicle. Thereafter, always use a high-grade SF rated engine oil or a high quality synthetic, & change the oil & filter every 3,000 miles. Never attempt to extend the oil change interval beyond 3,000 miles, regardless of oil manufacturer's claims as potential damage to the supercharger may result.

TOOL & SUPPLY REQUIREMENTS

- 1/4" drive & 3/8" drive ratchet and socket set: SAE & metric
- Open end wrenches: SAE & metric
- 1/4" drive & 3/8" drive ratchet extensions
- Torx 20 tool
- Screwdriver set
- Hose cutters
- Stepless / Oetiker clamp tool
- 3/8" fuel line quick disconnect tool
- Small reciprocating saw OR small hand saw
- Small drum sander OR small grinding wheel
- Drill motor
- Round file
- 9/32" drill bit, #4 or 7/32" drill bit
- Electrical Tape

If it has been 15,000 miles or more since your vehicle's last spark plug change, then you will also need:

- Spark plug socket
- NEW spark plugs

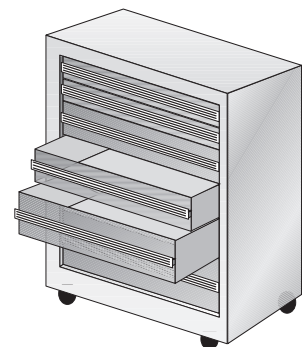



2018-2019 Ford Mustang GT, H.O.

Part No. 4FQ218-234JT

PARTS LIST

IMPORTANT: Before beginning installation, verify that all parts are included in the kit. Report any shortages or damaged parts immediately.

PART NO.	DESCRIPTION	QTY.	PART NUMBER	DESCRIPTION	QTY.
008110	SMALL SILVER DIE CUT DECAL	2	4FQ112-120	AIR INLET ASY, '18 MUST GT	1
008130	LICENSE PLATE FRAME, VORTECH1		008358	DECAL, INLET, '11+ MSTG GT VORT	1
008447	1 YR S/C STRT INFO PKG ASY VORT	1	4FQ012-110	INLET DUCT, 2015 MUSTANG GT	1
009035	S/C LUBE, BOTTLED, 3-PACK	1	5W001-039	1" HEAT SHRINK TUBING	3IN
2F329-244	V3-JT S/C ASY, '18 MUST GT, BLK 1		5W001-082	SLEEVE, FLEX BRAID .75" NOM.	1FT
4FQ020-025	INSTR MAN, '18-'20 MUST GT	1	7J006-093	6MM WASHER, PLATED	2
4FQ111-019	MNTG BRKT ASY, '18 MUST GT	1	7P250-045	1/4 MALE NPT X 3/8 MALE BARB	1
2A017-875-27	SPACER, .875OD X .404ID X 1.895L	4	7P375-106	PCV VALVE, FORD, 3/8" HOSE	1
2A017-875-28	SPACER, .875 OD X 2.730 LONG	1	7P500-039	1/2 NPT X 5/8 BARB 90 , PLATED	1
2A017-876-13	SPACER, .875OD X .328ID X 2.730L	2	7P625-091	5/8 X 5/8 X 90 BARB ELBOW, PLASTIC	1
2A017-876-14	SPACER, .875OD X .328ID X 2.058L	2	7P625-375	REDUCER, 5/8 BARB TO 3/8 BARB	1
2A017-876-15	SPACER, .875OD X .328ID X 2.146L	1	7PS400-200	SLEEVE, BLACK 4.0D X 2.0	1
2A017-876-16	SPACER, .875OD X .328ID X 1.928L	1	7PS400-351	REDUCER SLEEVE,4.0 X 3.5 X 2.35L	1
2A046-020	BELT, 6 RIB X 102", 5061020 DAYCO	1	7PS425-400	REDUCER, SILICONE BUMP, 4.25" X 4"	1
4FQ010-015	MNTG PLT, OUTER, '18 MUST GT	1	7R002-052	#52 SAE TYPE F SS HOSE CLAMP	1
4FQ010-025	MNTG PLT, INNER, '18 MUST GT	1	7R002-064	#64 SAE TYPE F SS HOSE CLAMP	4
4FQ017-021	SPCR, .875/1.25OD X .328ID X 1.782L	1	7R004-002	STEPLESS CLAMP, 17.0	2
4FQ017-031	IDLER SPACER, .875OD X .363L	4	7R004-004	STEPLESS CLAMP, 25.6	7
4GF016-161	IDLER, 3.0, 6-RIB GROOVED, MOD	1	7R004-007	STEPLESS CLAMP, 28.6	1
4PCS016-160	IDLER, 6 RIB SMOOTH, 3.5", COMP.	1	7U030-056	3/8 PCV/VAC RUBBER HOSE	3 FT
4TX016-150	IDLER, 2.75 DIA, SMOOTH, 7 RIB	2	7U033-000	5/8" PCV HOSE	2.5 FT
7A375-126	3/8-16 X 1.25 HHCS, GR8, PLT	5	7U100-055	TIE WRAP, 7.5" NYLON	10
7A375-352	3/8-16 X 3.5" HX HD GR8	4	8A004-007-1	BLK OFF PLT, VORT, FORD SLOT MAF	1
7A357-353	3/8-16 X 3.50" BHCS	1	4FQ114-040	ENG COOLNT MOD ASY, '18 MUST 1	
7C080-064	M8 X 1.25 X 65MM BHCS CL10.9	1	4FQ010-100	BRKT A, SURGE TANK, '18 MUST GT	1
7C080-081	M8 X 1.25 X 80 HXHD CL10.9	1	4FQ010-110	BRKT B, SURGE TANK, '18 MUST GT	1
7C080-101	M8 X 1.25 X 100MM BHCS CL10.9	1	7A250-051	1/4-20 X .50 HHCS GR5 ZINC PLTD	2
7C080-200	M8 X 1.25 X 200MM STUD	2	7A312-100	5/16-18 X 1 HHCS, GR5, PLATED	1
7F008-021	NUT, M8 X 1.25, SERRATED FLG	2	7F312-017	5/16-18 NYLOCK NUT	1
7J312-000	5/16 FLAT WASHER-SAE	3	7K250-001	1/4" AN WASHER	2
7K375-040	3/8 AN960 FLAT WASHER PLATED	9	7K312-001	5/16 AN WASHER, PLATED	2
4FQ112-084	DISCH ASY, '18 MUST GT, BLK 1		7P375-075	3/4" HOSE BARB UNION, BRASS	1
2A017-875-10	SPACER, .875 OD X .430 LONG	1	7P375-098	TEE, 3/8" INCH, PLASTIC	1
4FQ012-090	DISCH TUBE C, '15-'18 MUSTANG GT	1	7R002-024	#24 SAE TYPE F SS HOSE CLAMP	2
4FQ012-151	DISCH TUBE B '18 MUSTANG	1	7R004-007	STEPLESS CLAMP, 28.6	2
4FQ017-081	SPACER, TB, '18 MUST GT	1	7R004-008	STEPLESS CLAMP, 18.5	2
4FQ020-027	TMPLT, RAD BRKT MOD, '18 MUST GT	1	7U030-109	VAC HOSE, 7/64 ID	.50 FT
4FQ112-104	DISCH TUBE D, '15-'18 MUST GT BLK	1	8N155-110	SURGE TANK, WELDED, '18 MUST GT	1
4FQ112-184	DISCH TUBE A, '18 MUST GT, BLK	1	5A003-150	PRGRMR, LIVERNOIS, '18 MUST 1	
7C040-008	M4-.7 X 8MM SCHD SS	2	5A102-036	ASY,VOLT BST,PNP,'15+ MUST GT 1	
7C060-022	M6 X 1.0 X 22MM SHCS LYSH SC	4	8D204-064	ASY, MAXFLOW BYPASS VALVE 1	
7C060-031	M6 X 1.0 X 30 BUTN HD ZN PLT	4	8F160-046	FUEL INJ ASY, '11+ MUST GT 1	
7F008-021	NUT, M8 X 1.25, SERRATED FLG	4	8H040-205	AIR FILTER, '15+ MUST GT 1	
7J312-875	5/16" WASHER, 7/8" OD, CUSTOM	4	8PN101-054	CHRG AIR CLR, '05+ MUST GT 1	
7P125-109	FTG, 1/8NPT - 1/4 BARB, AL	1			
7PS300-300	SLEEVE, BLACK, 3.00D X 3.00	2			
7PS300-301	BUMP HOSE, 3.00D X 3.00L	1			
7PS350-301	REDUCER, BLK 3.5-3.0 X 3.0L	1			
7PS350-304	SLEEVE, BLACK 3.50" D X 3.0" L	1			
7PS400-350	REDUCER, BLK 4.0-3.5 X 3.0L	1			
7PS400-364	ELBOW,4.0 X 3.5 S-SHAPED, '18 MUST	1			
7R002-048	#48 SAE TYPE F SS HOSE CLAMP	7			
7R002-056	#56 SAE TYPE F SS HOSE CLAMP	5			
7R002-064	#64 SAE TYPE F SS HOSE CLAMP	2			
7U012-238	O-RING, 2-238, 3.484ID X .139	1			
7U030-218	7/32 VAC HOSE, BUNA-N	3.5 FT			
7U100-066	TIE WRAP, 11" NYLON	3			
7U375-056	1" VACUUM CAP FOR 1" NIPPLE	1			
8A003-074	MAF, 3.8 ID, BLACK	1			



2018-2020 Ford Mustang GT, H.O. Tuner Kit

Part No. 4FQ218-334JT

PARTS LIST

IMPORTANT: Before beginning installation, verify that all parts are included in the kit. Report any shortages or damaged parts immediately.

PART NO.	DESCRIPTION	QTY.	PART NUMBER	DESCRIPTION	QTY.
008110	SMALL SILVER DIE CUT DECAL	2	4FQ112-120	AIR INLET ASY, '18 MUST GT	1
008130	LICENSE PLATE FRAME, VORTECH	1	008358	DECAL, INLET, '11+ MSTG GT VORT	1
008447	1 YR S/C STRT INFO PKG ASY VORT	1	4FQ012-110	INLET DUCT, 2015 MUSTANG GT	1
009035	S/C LUBE, BOTTLED, 3-PACK	1	5W001-039	1" HEAT SHRINK TUBING	31N
2F329-244	V3-JT S/C ASY, '18 MUST GT, BLK	1	5W001-082	SLEEVE, FLEX BRAID .75" NOM.	1FT
4FQ020-025	INSTR MAN, '18-'20 MUST GT	1	7J006-093	6MM WASHER, PLATED	2
4FQ111-019	MNTG BRKT ASY, '18 MUST GT	1	7P250-045	1/4 MALE NPT X 3/8 MALE BARB	1
2A017-875-27	SPACER, .875OD X .404ID X 1.895L	4	7P375-106	PCV VALVE, FORD, 3/8" HOSE	1
2A017-875-28	SPACER, .875 OD X 2.730 LONG	1	7P500-039	1/2 NPT X 5/8 BARB 90 , PLATED	1
2A017-876-13	SPACER, .875OD X .328ID X 2.730L	2	7P625-091	5/8 X 5/8 X 90 BARB ELBOW, PLASTIC	1
2A017-876-14	SPACER, .875OD X .328ID X 2.058L	2	7P625-375	REDUCER, 5/8 BARB TO 3/8 BARB	1
2A017-876-15	SPACER, .875OD X .328ID X 2.146L	1	7PS400-200	SLEEVE, BLACK 4.0D X 2.0	1
2A017-876-16	SPACER, .875OD X .328ID X 1.928L	1	7PS400-351	REDUCER SLEEVE, 4.0 X 3.5 X 2.35L	1
2A046-020	BELT, 6 RIB X 102", 5061020 DAYCO	1	7PS425-400	REDUCER, SILICONE BUMP, 4.25" X 4"	1
4FQ010-015	MNTG PLT, OUTER, '18 MUST GT	1	7R002-052	#52 SAE TYPE F SS HOSE CLAMP	1
4FQ010-025	MNTG PLT, INNER, '18 MUST GT	1	7R002-064	#64 SAE TYPE F SS HOSE CLAMP	4
4FQ017-021	SPCR, .875/1.25OD X .328ID X 1.782L	1	7R004-002	STEPLESS CLAMP, 17.0	2
4FQ017-031	IDLER SPACER, .875OD X .363L	4	7R004-004	STEPLESS CLAMP, 25.6	7
4GF016-161	IDLER, 3.0, 6-RIB GROOVED, MOD	1	7R004-007	STEPLESS CLAMP, 28.6	1
4PCS016-160	IDLR, 6 RIB SMOOTH, 3.5", COMP.	1	7U030-056	3/8 PCV/VAC RUBBER HOSE	3 FT
4TX016-150	IDLER, 2.75 DIA, SMOOTH, 7 RIB	2	7U033-000	5/8" PCV HOSE	2.5 FT
7A375-126	3/8-16 X 1.25 HHCS, GR8, PLT	5	7U100-055	TIE WRAP, 7.5" NYLON	10
7A375-352	3/8-16 X 3.5" HX HD GR8	4	8A004-007-1	BLK OFF PLT, VORT, FORD SLOT MAF	1
7A357-353	3/8-16 X 3.50" BHCS	1	4FQ114-040	ENG COOLNT MOD ASY, '18 MUST	1
7C080-064	M8 X 1.25 X 65MM BHCS CL10.9	1	4FQ010-100	BRKT A, SURGE TANK, '18 MUST GT	1
7C080-081	M8 X 1.25 X 80 HXHD CL10.9	1	4FQ010-110	BRKT B, SURGE TANK, '18 MUST GT	1
7C080-101	M8 X 1.25 X 100MM BHCS CL10.9	1	7A250-051	1/4-20 X .50 HHCS GR5 ZINC PLTD	2
7C080-200	M8 X 1.25 X 200MM STUD	2	7A312-100	5/16-18 X 1 HHCS, GR5, PLATED	1
7F008-021	NUT, M8 X 1.25, SERRATED FLG	2	7F312-017	5/16-18 NYLOCK NUT	1
7J312-000	5/16 FLAT WASHER-SAE	3	7K250-001	1/4" AN WASHER	2
7K375-040	3/8 AN960 FLAT WASHER PLATED	9	7K312-001	5/16 AN WASHER, PLATED	2
4FQ112-084	DISCH ASY, '18 MUST GT, BLK	1	7P375-075	3/4" HOSE BARB UNION, BRASS	1
2A017-875-10	SPACER, .875 OD X .430 LONG	1	7P375-098	TEE, 3/8" INCH, PLASTIC	1
4FQ012-090	DISCH TUBE C, '15-'18 MUSTANG GT	1	7R002-024	#24 SAE TYPE F SS HOSE CLAMP	2
4FQ012-151	DISCH TUBE B '18 MUSTANG	1	7R004-007	STEPLESS CLAMP, 28.6	2
4FQ017-081	SPACER, TB, '18 MUST GT	1	7R004-008	STEPLESS CLAMP, 18.5	2
4FQ020-027	TMPLT, RAD BRKT MOD, '18 MUST GT	1	7U030-109	VAC HOSE, 7/64 ID	.50 FT
4FQ112-104	DISCH TUBE D, '15-'18 MUST GT BLK	1	8N155-110	SURGE TANK, WELDED, '18 MUST GT	1
4FQ112-184	DISCH TUBE A, '18 MUST GT, BLK	1	8D204-064	ASY, MAXFLOW BYPASS VALVE	1
7C040-008	M4-.7 X 8MM SCHD SS	2	8H040-205	AIR FILTER, '15+ MUST GT	1
7C060-022	M6 X 1.0 X 22MM SHCS LYSH SC	4	8PN101-054	CHRG AIR CLR, '05+ MUST GT	1
7C060-031	M6 X 1.0 X 30 BUTN HD ZN PLT	4			
7F008-021	NUT, M8 X 1.25, SERRATED FLG	4			
7J312-875	5/16" WASHER, 7/8" OD, CUSTOM	4			
7P125-109	FTG, 1/8NPT - 1/4 BARB, AL	1			
7PS300-300	SLEEVE, BLACK, 3.00D X 3.00	2			
7PS300-301	BUMP HOSE, 3.00D X 3.00L	1			
7PS350-301	REDUCER, BLK 3.5-3.0 X 3.0L	1			
7PS350-304	SLEEVE, BLACK 3.50" D X 3.0" L	1			
7PS400-350	REDUCER, BLK 4.0-3.5 X 3.0L	1			
7PS400-364	ELBOW, 4.0 X 3.5 S-SHAPED, '18 MUST	1			
7R002-048	#48 SAE TYPE F SS HOSE CLAMP	7			
7R002-056	#56 SAE TYPE F SS HOSE CLAMP	5			
7R002-064	#64 SAE TYPE F SS HOSE CLAMP	2			
7U012-238	O-RING, 2-238, 3.484ID X .139	1			
7U030-218	7/32 VAC HOSE, BUNA-N	3.5 FT			
7U100-066	TIE WRAP, 11" NYLON	3			
7U375-056	1" VACUUM CAP FOR 1" NIPPLE	1			
8A003-074	MAF, 3.8 ID, BLACK	1			

This page was left intentionally blank.

1. BASIC COMPONENT REMOVAL

- A. Prior to unplugging the battery, you will need to roll down both windows as you will be working within the vehicle in a later step. This is done to prevent potential window damage as both windows rest within a channel in the body of the vehicle when they are rolled up.
(See Fig. 1-a)



Fig. 1-a: Roll Down Windows

- B. Remove the battery cover by removing the 3x plastic fasteners & pulling the battery cover forward. Unplug the battery leads.
(See Fig. 1-b)



Fig. 1-b: Unplug Battery Leads

- C. If your vehicle is equipped with a strut tower brace, remove the 4x 15mm-headed nuts & remove the strut tower brace from the vehicle.
(See Fig. 1-c)



Fig. 1-c: Remove Strut Tower Brace

1. BASIC COMPONENT REMOVAL, cont'd

- D. Remove 8x plastic fasteners securing the radiator support cover. Pop the center section of each fastener upward and then the larger part of the fastener will loosen. Proceed to remove the cover.

(See Fig. 1-d)



Fig. 1-d: Remove Radiator Support Cover

- E. Remove the 6x 8mm-headed fasteners & 2x 5.5mm-headed fasteners securing the front bumper cover to the upper radiator support.

(See Fig. 1-e)

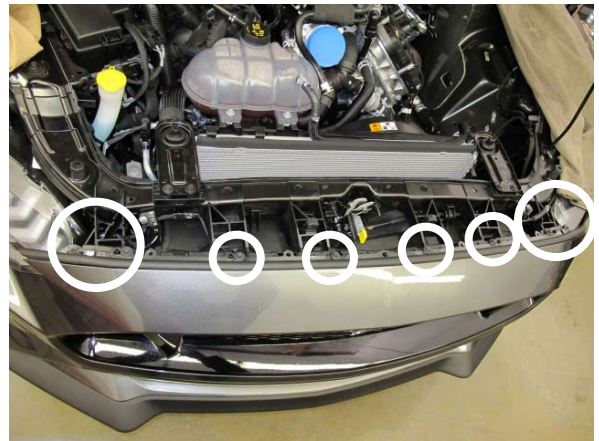

Fig. 1-e: Remove Front Bumper Cover Fasteners

- F. Remove the 3x plastic fasteners securing the fender liners to the fenders & lower splash guard. To remove these fasteners, simply push down on the center. Do this for both sides.

(See Fig. 1-f)



Fig. 1-f: Remove Fender Liner Fasteners

1. BASIC COMPONENT REMOVAL, cont'd

- G. Remove the 2x plastic fasteners securing the lower splash guard to the fender liners. Pop the center section of each fastener upward and then the larger part of the fastener will loosen. Do this for both sides.

(See Fig. 1-g)

NOTE: Performance-Pack Vehicle splash-guard shown in Fig. 1-g. Base-model vehicle splash guard may vary.



Fig. 1-g: Remove Plastic Fasteners

- H. Located on each side of the engine bay, behind each headlight, is a triangle-shaped opening. In the following step, you will use this opening as it allows for easier access to the corner bracket fasteners securing the corners of the front bumper cover to the fenders.

(See Fig. 1-h)

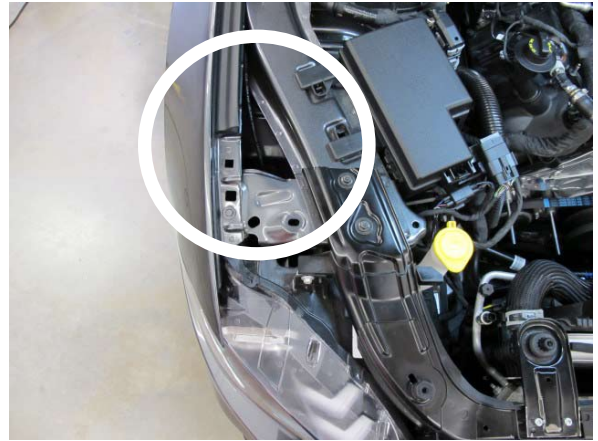

Fig. 1-h: Access Opening

- I. On both corners of the front bumper cover, remove the 2x 10mm-headed fasteners securing the corner brackets. Do this for both sides.

(See Fig. 1-i)

NOTE: It is easiest to use 1/4" drive tools for this step.



Fig. 1-i: Remove Corner Bracket Fasteners

1. BASIC COMPONENT REMOVAL, cont'd

- J. Pull the fender liner away from the vehicle. With the corner bracket fasteners removed, detach the corner brackets from the vehicle by pulling them down. The corner brackets are held in place by a plastic push fastener, so you will need to use some force to remove them from the vehicle. Do this for both sides.
(See Fig. 1-j)



Fig. 1-j: Remove Corner Brackets

- K. Remove the lower splash guard by removing the 19x 7mm-headed fasteners & 2x plastic fasteners. Pop the center section of each plastic fastener upward and then the larger part of the fastener will loosen.
(See Fig. 1-k)



Fig. 1-k: Remove Lower Splash Guards

- L. Reach up behind the front bumper cover & unplug the bumper light connector. Do this for both sides.
(See Fig. 1-l)



Fig. 1-l: Unplug Bumper Lights

1. BASIC COMPONENT REMOVAL, cont'd

- M. Pull the corners of the front bumper cover away from the fender. Carefully remove the front bumper cover from the vehicle, exposing the bumper support.
(See Fig. 1-m)



Fig. 1-m: Remove Front Bumper Cover

- N. Unplug the electrical connector from the ambient air temperature sensor, then detach the harness from the front bumper support. Remove the sensor & set aside for reinstallation in a later step.
(See Fig. 1-n)

NOTE: Vehicles equipped with Active Grille Shutters, proceed to Step O. All others, skip to Step T.

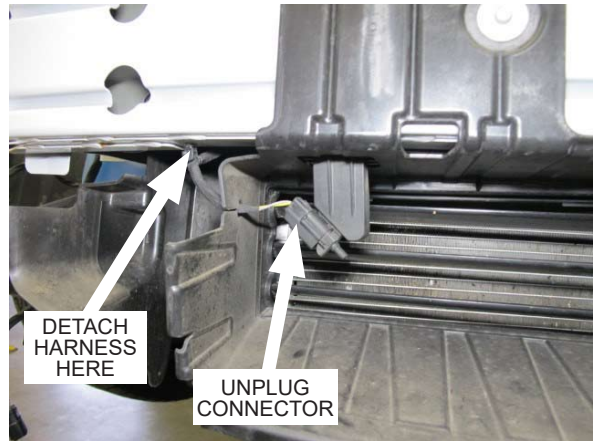

Fig. 1-n: Remove Ambient Air Temperature Sensor

- O. In order to install the charge air cooler, it will be necessary to remove the active grille shutters. Once removed, they will not be reused.
(See Fig. 1-o)



Fig. 1-o: Remove 8mm-Headed Fasteners

1. BASIC COMPONENT REMOVAL, cont'd

- P. Remove the 2x plastic fasteners securing the top of the active grille shutters to the upper radiator support.
(See Fig. 1-p)

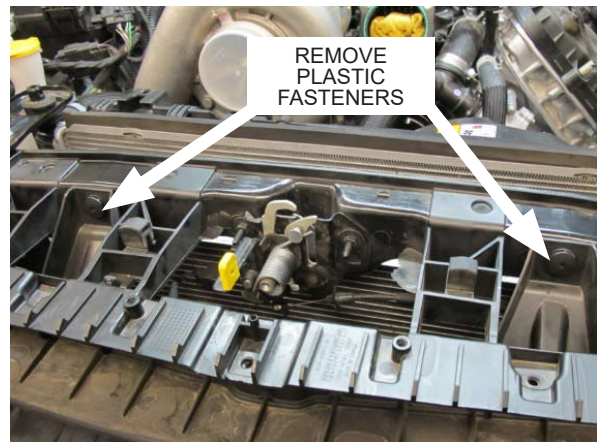

Fig. 1-p: Remove Plastic Fasteners

- Q. Remove the 2x 8mm-headed fasteners securing the middle section of the active grille shutters to the front bumper support. Next, remove the 2x 8mm-headed fasteners securing the bottom of the active grille shutters.
(See Fig. 1-q)

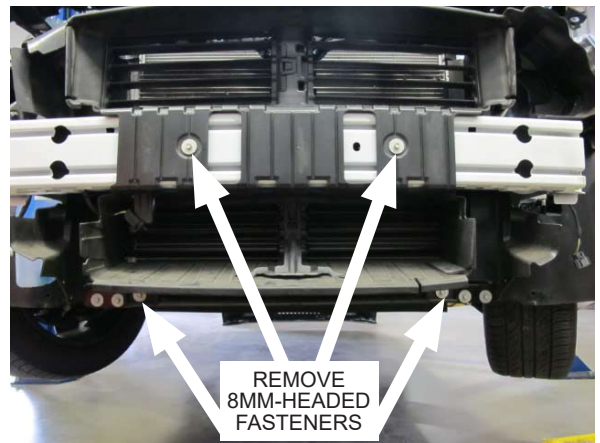

Fig. 1-q: Remove 8mm-Headed Fasteners

- R. In order to remove the active grille shutters, you will need to reach behind the active grille shutter assembly & detach the arm that connects the upper & lower active grille shutters together from the back side. Remove the 2x 5.5mm-headed fasteners securing the arm to the upper active grille shutters, then pry the arm away.
(See Fig. 1-r)

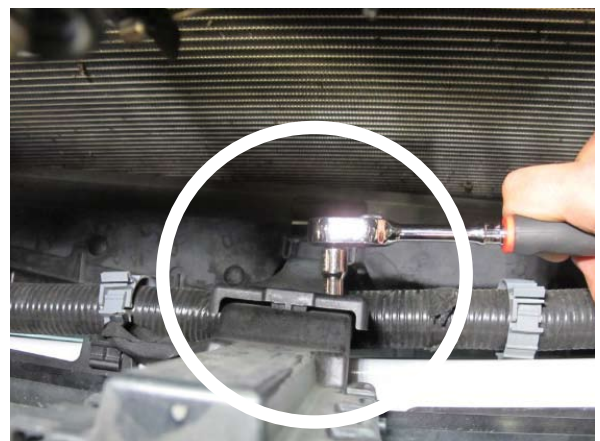

Fig. 1-r: Remove 2x 5.5mm-Headed Fasteners

1. BASIC COMPONENT REMOVAL, cont'd

- S. With the active grille shutter arm detached, pull the active grille shutter assembly away from the vehicle, then reach from behind & disconnect the active grille shutter motor. Once disconnected, remove the active grille shutter assembly & set aside. They will not be reused.
(See Fig. 1-s)



Fig. 1-s: Unplug Motor & Remove Active Grille Shutter Assembly

- T. There are 2x detachable panels that cover 2x 10mm-headed fasteners securing the engine cover. Remove the 2x panels & remove the 2x 10mm-headed fasteners. With the fasteners removed, pull up on the engine cover & remove it from the vehicle.
(See Fig. 1-t)



Fig. 1-t: Remove Engine Cover

- U. Detach any hoses attached to the air inlet tube. Loosen the hose clamps securing the air inlet tube to the throttle body & air box, then proceed to remove the air inlet tube from the vehicle. It will not be reused.
(See Fig. 1-u)



Fig. 1-u: Remove OEM Air Inlet

1. BASIC COMPONENT REMOVAL, cont'd

- V. Unplug the MAF sensor connector, then detach the harness from the air box lid. Remove the 10mm-headed fastener securing the air box to the vehicle. With the fastener removed, proceed to remove the air box assembly from the vehicle.

(See Fig. 1-v)

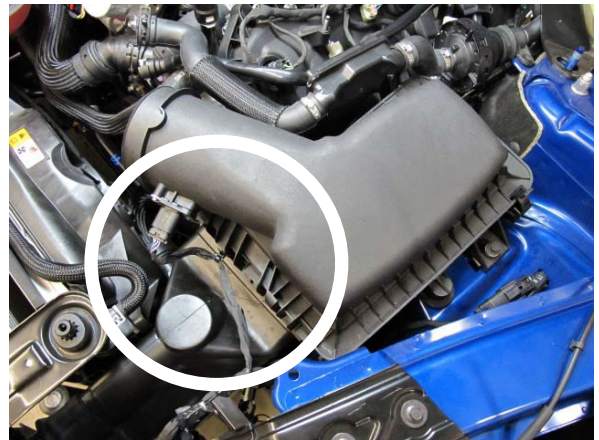

Fig. 1-v: Remove Air Box

- W. Remove the radiator cap from the engine coolant reservoir near the passenger side front of the engine compartment. Locate the engine coolant drain valve at the bottom passenger side corner of the radiator. Open the valve and drain the coolant into a clean container for later reuse. Once enough coolant has been drained, proceed to close the valve.

(See Fig. 1-w)



Fig. 1-w: Drain Engine Coolant

- X. Unclamp and remove the 2x small hoses from the upper portion of the coolant reservoir, then unclamp & remove the larger hose from the bottom of the coolant reservoir. Be prepared to catch any spillage. Remove the 2x 10mm-headed fasteners securing the coolant reservoir. Remove the reservoir and set it aside. It will not be reused.

(See Fig. 1-x)



Fig. 1-x: Remove Coolant Reservoir

1. BASIC COMPONENT REMOVAL, cont'd

- Y. Release the quick release upper radiator hose connection to the thermostat housing by pulling the spring clip back and sliding the hose fitting off. Remove the upper radiator hose and set it aside for later modification. Remove the coolant hose to the right of the "Y" fitting, above the thermostat housing & set it aside for modification in a later step.
(See Fig. 1-y)

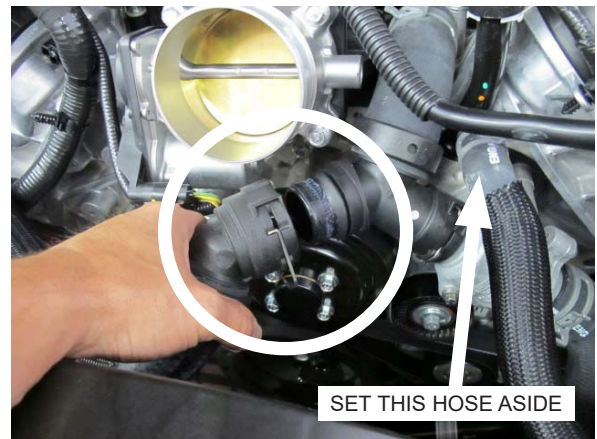

Fig. 1-y: Remove Upper Radiator Hose

- Z. Use a 15mm wrench to rotate the belt tensioner counter-clockwise to release tension from the 6-rib accessory drive belt. Remove the belt and set it aside as it will not be reused.
(See Fig. 1-z)



Fig. 1-z: Remove Accessory Drive Belt

- AA. Unplug the electrical connector from the throttle body by sliding the red clip outward and depressing the tab. Remove the 4x 8mm-headed fasteners securing the throttle body to the intake manifold & set them aside as they will be reused in a later step. Remove the throttle body and set it aside, ensuring that the o-ring remains on the intake manifold. Temporarily place a rag in the intake manifold to keep foreign debris from entering the engine.
(See Fig. 1-aa)

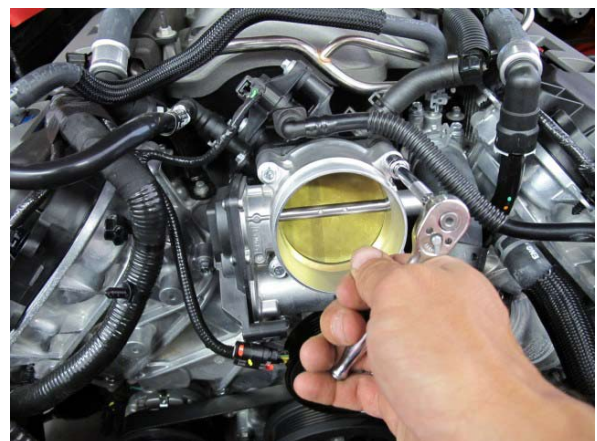

Fig. 1-aa: Remove Throttle Body

1. BASIC COMPONENT REMOVAL, cont'd

- AB. Remove the threaded clips from the coolant reservoir mounts, then proceed to cut off the coolant reservoir mount closest to the driver side of the vehicle. You will also need to grind down the tab with the rubber grommet located to the right of the coolant reservoir mount that will be ground down. This is to make room for the provided air inlet tube. You may need to make further adjustments once installed.

(See Fig. 1-ab)



Fig. 1-ab: Modify Fan Shroud

- AC. Remove the passenger side headlight by removing the 2x 10mm-headed fasteners & 1x 13mm-headed fastener. Disconnect the electrical plug & set the headlight aside.

(See Fig. 1-ac)

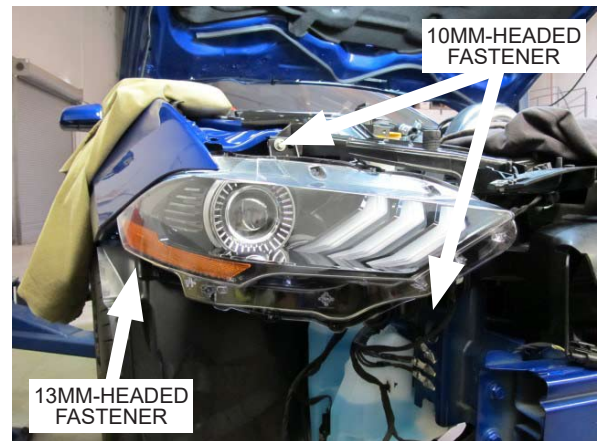

Fig. 1-ac: Remove Passenger Side Headlight

2. SUPERCHARGER MOUNTING BRACKET INSTALLATION

NOTE: Use blue thread locker on all supercharger mounting bracket assembly hardware.

- A. Remove the following 3x 10mm-headed screws securing the engine front cover on the passenger side:
- The uppermost screw
 - The screw just above the A/C compressor
 - The screw between the A/C compressor & the crank shaft.

(See Fig. 2-a)



Fig. 2-a: Remove 3x Engine Cover Fasteners

- B. Inspect the supercharger mounting bracket assembly and familiarize yourself with its components and configuration. The new belt should be routed so that the ribbed side engages the ribbed idler pulley and the smooth side rides on the other pulleys. The belt will remain within the supercharger mounting bracket assembly during installation. Note the multiple mounting locations of the ribbed idler, used to compensate for different supercharger pulley sizes and belt lengths. All 4x idler mounting bolts should be hand-tight during installation to facilitate alignment.

(See Fig. 2-b)



Fig. 2-b: Inspect Supercharger Mounting Bracket Assembly

- C. Locate the smooth idler closest to the top of the supercharger mounting bracket assembly. This idler & its associated hardware will need to be temporarily removed in order to install the supercharger mounting bracket assembly to the vehicle. Set aside for reinstallation in a later step.

(See Fig. 2-c)

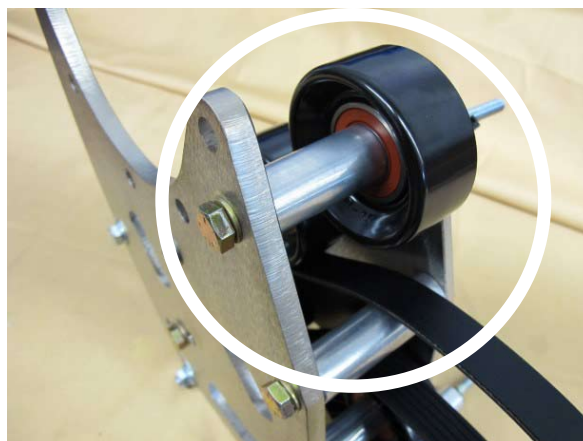

Fig. 2-c: Remove Smooth Idler Pulley & Set Aside

2. SUPERCHARGER MOUNTING BRACKET INSTALLATION, cont'd

- D. Remove the 4x spacers that are circled in Fig. 2-d. Make note of their location within the supercharger mounting bracket assembly as they are all different lengths.

(See Fig. 2-d)

NOTE: If by accident you forget the original location of the spacers, refer to **Appendix A & Appendix B** near the back of this manual for an assembly diagram.

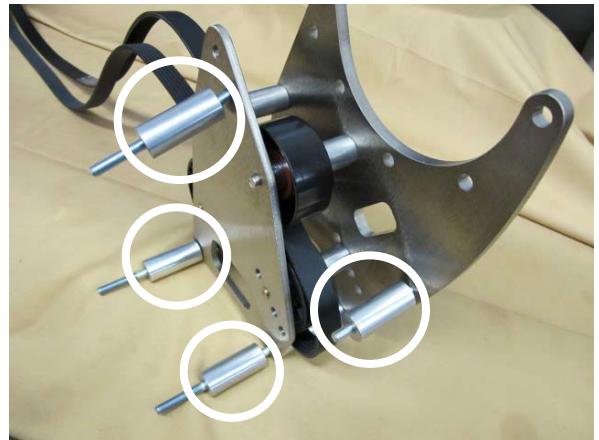

Fig. 2-d: Remove Spacers & Set Aside

- E. Near the bottom of the supercharger mounting bracket assembly there are 2x 2.730" spacers sandwiched in between the supercharger mounting plates. These spacers are usually held in place by the 2x M8 x 200mm studs, which will be removed during the next step. These spacers need to remain in place during installation of the supercharger mounting bracket assembly.

(See Fig. 2-e)

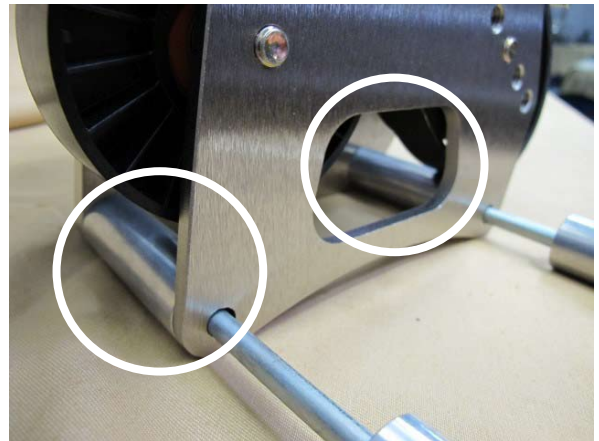

Fig. 2-e: 2x 2.730" Spacers

- F. Remove the 2x M8 x 200mm studs from the supercharger bracket assembly. Remove the nuts & washers from the studs, then proceed to install the studs into the lower 2x engine cover fastener holes in the locations of the previously-removed fasteners (one on each side of the A/C compressor).

(See Fig. 2-f)



Fig. 2-f: Install Threaded Spacers

2. SUPERCHARGER MOUNTING BRACKET INSTALLATION, cont'd

- G. Slide 1x 2.058" spacer over the stud to the left of the A/C compressor. Slide 1x 2.146" spacer over the stud to the right of the A/C compressor. Measuring from the front of the spacer, leave 3.75" of the M8 x 200mm stud exposed. (See Fig. 2-g)



Fig. 2-g: Install 1x 2.058" & 1x 2.146" Spacers

- H. As mentioned in the note in Step E, the 2x 2.730" spacers sandwiched in between the supercharger mounting plates are normally held in place by the 2x M8 x 200mm studs. During the installation of the supercharger mounting bracket assembly to the vehicle, make sure that the 2x M8 x 200mm studs pass through the mounting plates & both spacers. (See Fig. 2-h)

NOTE: Slightly tightening the 4x 3/8-16 x 3.50" screws holding the supercharger mounting bracket assembly together will trap the 2x 2.730" spacers & help keep them in place while during installation.



Fig. 2-h: Keep 2x 2.730" Spacers In Place

- I. Position the supercharger mounting bracket assembly in the engine compartment, then slide the 2x lower mounting holes onto the 2x M8 x 200mm studs, making sure they pass through both mounting plates & the 2x 2.730" spacers sandwiched in between the mounting plates. (See Fig. 2-i)



Fig. 2-i: Install Supercharger Mounting Bracket Assembly

2. SUPERCHARGER MOUNTING BRACKET INSTALLATION, cont'd

- J. Locate the previously removed 2.058" spacer & place it between the rear mounting plate & the uppermost engine timing cover hole. Using a 5mm hex tool, secure the M8 x 100mm button head cap screw to the uppermost engine timing cover hole.
(See Fig. 2-j)



Fig. 2-j: Install 1x 2.058" Spacer

- K. Locate the previously removed 1.928" spacer, M8 x 80mm screw & 5/16 washer. Place the spacer in between the front mounting plate & cylinder head. Using the M8 x 80mm screw & 5/16 washer, secure the front plate & spacer to the cylinder head.
(See Fig. 2-k)

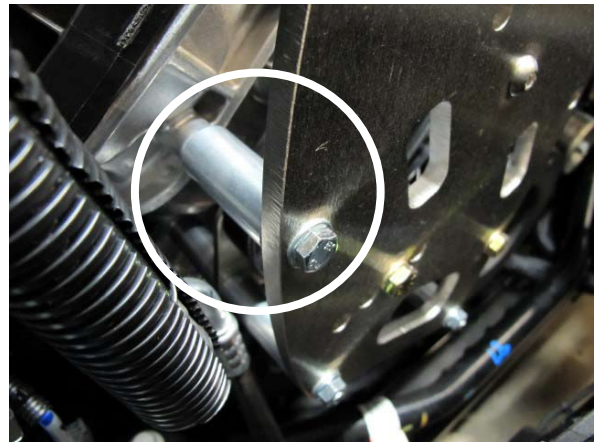

Fig. 2-k: Install 1x 1.928" Spacer

- L. Locate the previously removed 2x M8 flanged nuts & 2x 5/16 washers & use them to secure the lower section of the supercharger mounting bracket to the previously installed 2x M8 x 200mm studs.
(See Fig. 2-l)



Fig. 2-l: Install 2x M8 Nuts & 2x 5/16" Washers

2. SUPERCHARGER MOUNTING BRACKET INSTALLATION, cont'd

- M. Locate the previously removed smooth idler, 1.895" spacer, pilot spacer, 3/8-16 x 3.50" screw & 3/8 AN washer. Place the smooth idler, 1.895" spacer & pilot spacer into their appropriate location between the mounting plates, then secure with the 3/8-16 x 3.50" screw & 3/8 AN washer.

(See Fig. 2-m)



Fig. 2-m: Install Previously Removed Smooth Idler Pulley

- N. On the right side of the supercharger mounting bracket assembly between the upper & lower smooth idlers there is another 2.730" spacer secured by a 3/8-16 x 3.50" screw & a 3/8 AN washer. Remove this spacer & hardware & set aside for reinstallation in a later step. This spacer is temporarily removed to gain better access to one of the 5x supercharger mounting screw locations. All other supercharger mounting bracket hardware can be tightened at this time.

(See Fig. 2-n)



Fig. 2-n: Remove This 1x 2.730" Spacer & Set Aside

- O. Notice the mounting holes on the front mounting plate. 3x of the screws can be easily accessed. However, the 2x screws that are circled will require the use of a long 9/16" boxed end wrench for ease of installation.

(See Fig. 2-o)



Fig. 2-o: Use long 9/16" Wrench To Install These Screws

2. SUPERCHARGER MOUNTING BRACKET INSTALLATION, cont'd

- P. Prior to installing the supercharger to the supercharger mounting bracket assembly, it is suggested that you lubricate the threads in the mounting bosses on the supercharger. To do this, locate the provided 5x 3/8-16 x 1.25" screws, lightly coat the screw threads with lubricant & screw them into the mounting bosses until they bottom out. Once complete, remove the screws from the mounting bosses. This process makes it easier to install the hard to reach supercharger mounting screws.

(See Fig. 2-p)



Fig. 2-p: Lubricate Supercharger Mounting Boss Threads

- Q. Place the supercharger onto the front mounting plate & begin to thread the 5x 3/8-16 x 1.25" supercharger mounting screws by hand, making sure to use 3/8 AN washers on all 5x screws. Once in position, proceed to tighten all 5x 3/8-16 x 1.25" supercharger mounting screws.

(See Fig. 2-q)



Fig. 2-q: Install Supercharger

- R. With the supercharger secured to the supercharger mounting bracket assembly, proceed to reinstall the previously removed 2.730" spacer, make sure that the drive belt runs above & below the spacer. Secure with the previously removed 3/8-16 x 3.50" screw & 3/8 AN washer.

(See Fig. 2-r)

NOTE: It may be necessary to slightly loosen the mounting bracket hardware directly above & below this screw hole in order for this spacer to slide back into place.



Fig. 2-r: Reinstall Previously Removed 1x 2.730" Spacer

2. SUPERCHARGER MOUNTING BRACKET INSTALLATION, cont'd

- S. Locate **Appendix C** near the back of this manual for the belt routing diagram. Route the belt as shown. Once in position, use a 15mm wrench to rotate the belt tensioner counter-clockwise, then slide the new drive belt over the smooth idler on the tensioner. Once the belt is in position & properly routed, release the tension on the belt tensioner.

(See Fig. 2-s)



Fig. 2-s: Install Supercharger Drive Belt

This page was left intentionally blank.

3. ENGINE COOLING SYSTEM MODIFICATON

NOTE: The following steps will show one upper radiator bracket being modified. However, be sure to do all steps for both upper radiator brackets.

- A. In order to provide adequate space for the discharge tubes, the upper radiator brackets will need to be modified in order to tilt the radiator assembly forward. Remove the 2x 10mm-headed fasteners & remove both upper radiator brackets from the vehicle.

(See Fig. 3-a)

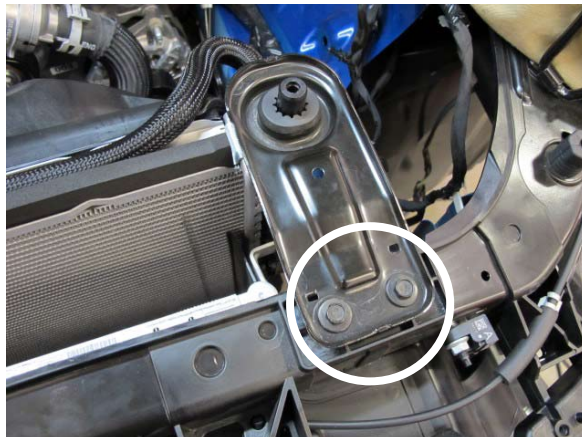

Fig. 3-a: Remove Upper Radiator Brackets

- B. On the underside of the radiator brackets, you will notice 2x protruding tabs. Using a grinding tool, remove the 2x protruding tabs.

(See Fig. 3-b)



Fig. 3-b: Remove 2x Protruding Tabs

- C. Locate the provided upper radiator modification template. Using a razor blade, cut out the 2x holes on the template with the 2x arrows pointing towards them. Line up the "cut out" holes to the existing holes on the underside of the upper radiator brackets. Secure the templates to the upper radiator brackets using tape or spray-on adhesive. Use a center punch to mark the centers of the holes to be drilled.

(See Fig. 3-c)



Fig. 3-c: Center Punch The Holes To Be Drilled

3. ENGINE COOLING SYSTEM MODIFICATON, cont'd

- D. Using a 9/32" drill bit & drill motor, drill out the center punched holes. On the hole that needs to be slotted, we suggest drilling out the hole closest to the edge of the upper radiator bracket, then use a small round file to safely slot the hole.

(See Fig. 3-d)



Fig. 3-d: Use Round File To Slot Hole

- E. Using a cutting tool, the original holes of the upper radiator mounting brackets will need to be cut off, just in front of the indented section of the upper radiator bracket. Use Fig. 4-r as an example.

(See Fig. 3-e)



Fig. 3-e: Cut The Upper Radiator Bracket As Shown

- F. Using a grinding tool, grind down the raised edges near the front of the upper radiator brackets down to a taper.

(See Fig. 3-f)



Fig. 3-f: Grind Down Raised Edges To A Taper

3. ENGINE COOLING SYSTEM MODIFICATON, cont'd

- G. Now that the upper radiator brackets are modified, loosely install them to the vehicle, but do not secure them with any fasteners at this time.
(See Fig. 3-g)



Fig. 3-g: Reinstall Modified Upper Radiator Brackets

- H. Making sure not to damage the coolant hose, carefully cut the OEM plastic hose clamp on the hose running between the "Y" on the thermostat housing & the engine water neck. Resecure the hose using one of the provided #24 hose clamps.
(See Fig. 3-h)



Fig. 3-h: Install #24 Hose Clamp

- I. Locate the previously removed OEM upper radiator hose. Remove the OEM spring clamp & set aside. Cut off 2" from the end of the hose.
(See Fig. 3-i)



Fig. 3-i: Upper Radiator Hose (OEM Configuration)

3. ENGINE COOLING SYSTEM MODIFICATON, cont'd

- J. Cut away the OEM plastic hose clamp on the quick-release end of the upper radiator hose, taking care not to damage the hose. Separate the hose from the quick-release fitting, then cut 1" off of the end of the hose.

(See Fig. 3-j)



Fig. 3-j: Remove Plastic Hose Clamp

- K. The upper radiator hose will need to be flipped when reinstalled to the vehicle in order to provide adequate space between the upper radiator hose & the supercharger. The end of the hose originally attached to the quick-release fitting will now be attached to the upper radiator inlet. The opposite end will now be attached to the quick-release fitting.

(See Fig. 3-k)



Fig. 3-k: Upper Radiator Hose (New Configuration)

- L. Once both ends of the hose are attached & properly clocked, secure the radiator side of the hose using the previously removed OEM spring clamp. Use the supplied #24 hose clamp to secure the quick-release side of the hose.

(See Fig. 3-l)



Fig. 3-l: Secure Quick-Release To Hose Using #24 Hose Clamp

3. ENGINE COOLING SYSTEM MODIFICATON, cont'd

- M. Locate the OEM molded coolant hose on the driver side of the radiator & turn it 90° so it points towards the bottom of the vehicle.
(See Fig. 3-m)



Fig. 3-m: Rotate The Driver Side OEM Molded Coolant Hose 90°

- N. Locate the upper OEM molded coolant hose near the top of the engine & rotate it 180° so it points near the driver side shock tower.
(See Fig. 3-n)

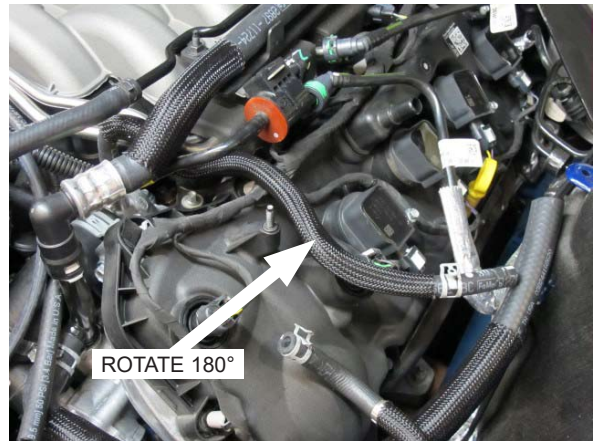

Fig. 3-n: Rotate Upper OEM Molded Coolant Hose 180°
(Rotated View Shown)

- O. The sound tube that normally goes from the OEM air inlet into the cabin of the vehicle will need to be cut in order to make room for the provided coolant tank that will be installed in a later step. Cut the sound tube as shown & install the provided cap. Be sure not to damage any brake lines, fuel lines or wiring during this process.
(See Fig. 3-o)

NOTE: For a cleaner looking installation, we suggest cutting the sound tube as short as possible so its out of sight, but making sure to leave enough material to install the cap.

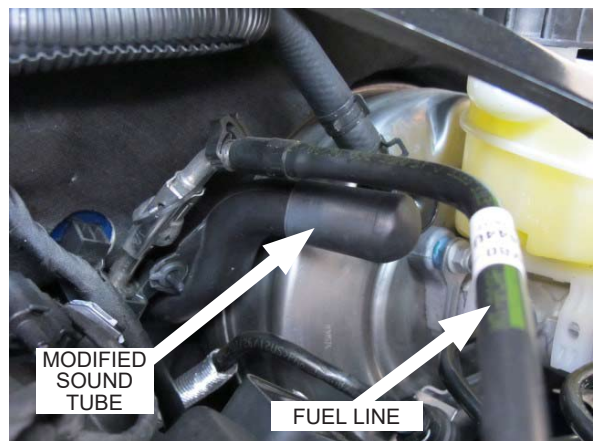

Fig. 3-o: Modified Sound Tube w/Cap

3. ENGINE COOLING SYSTEM MODIFICATON, cont'd

- P. There is an EVAP hose secured to the driver side shock tower by a plastic fastener. Release the plastic fastener from the driver side shock tower & push the EVAP hose aside. This is done to make room for the provided coolant tank that will be installed in a later step.

(See Fig. 3-p)



Fig. 3-p: Release EVAP Hose From Driver Side Shock Tower

- Q. Locate coolant tank bracket B that is provided with this kit, as well as the provided 5/16-18 x 1.00" screw, 5/16-18 nylock nut & 2x 5/16 washers. There is a small stand-off with a hole that is located on the driver side shock tower. With coolant tank bracket B placed on top off the stand-off, secure it with the provided hardware, but do not tighten it at this time.

(See Fig. 3-q)

NOTE: In some cases, it may be necessary to clean up the inside of the hole on the stand-off as there may be a thick layer of paint, making it difficult to fit the provided 5/16-18 x 1.00" screw.



Fig. 3-q: Secure Coolant Tank Bracket B

- R. Locate the provided coolant tank & coolant tank bracket A. Remove the 15mm-headed fastener as shown in Fig. 3-k, then loosely secure coolant tank bracket A as shown. Next, locate the 2x provided 1/4-20 x .50" screws & 2x 1/4" washers & loosely secure the provided coolant tank to coolant tank bracket A & coolant tank bracket B.

(See Fig. 3-r)



Fig. 3-r: Loosely Attach Coolant Tank

3. ENGINE COOLING SYSTEM MODIFICATON, cont'd

- S. You will notice that the coolant tank brackets are both slotted. This is done to allow you to move the coolant tank for proper clearance. Temporarily reinstall the engine cover & strut tower brace (if equipped) & position the coolant tank so the radiator cap is clear of both components but also making sure that the coolant tank doesn't come into contact with the underside of the strut tower brace. Once in position, proceed to tighten all coolant tank hardware. You may remove the engine cover & strut tower brace at this time.

(See Fig. 3-s)



Fig. 3-s: Position Coolant Tank

- T. Locate the upper OEM molded coolant hose that was rotated in Step G & attach it to the upper hose bung on the provided coolant tank. Secure using the OEM spring clamp.

(See Fig. 3-t)



Fig. 3-t: Attach Upper OEM Molded Coolant Hose

- U. Locate the previously removed 3/4" OEM coolant hose that was attached to the underside of the OEM coolant tank. Temporarily remove the 2x OEM spring clamps & the protective nylon cover. If you look closely, one of the ends of the hose is labeled "ENG", which means it is the engine side of the hose. Attach the opposite end of the hose to the provided coolant tank as shown in Fig. 3-n & route it towards the coolant fitting located above the thermostat housing. The engine side of the hose will be modified in the next step.

(See Fig. 3-u)

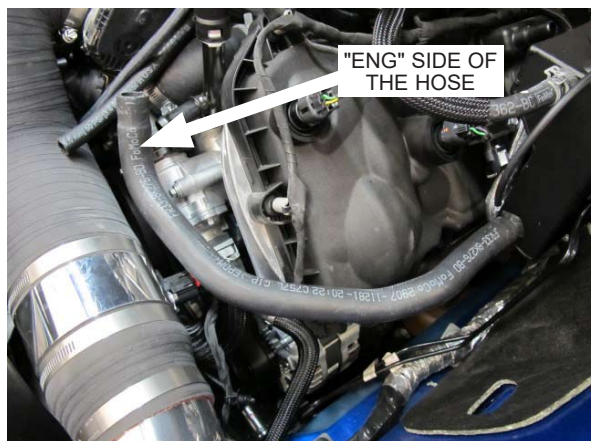

Fig. 3-u: OEM 3/4" Coolant Hose (Unmodified)

3. ENGINE COOLING SYSTEM MODIFICATON, cont'd

- V. Cut the hose as shown & rotate the engine side of the hose 90° then attach it to the coolant fitting located above the thermostat housing. Locate the provided 3/4" brass hose mender & 2x 28.6 stepless clamps & use them to mend the hose back together.
(See Fig. 3-v)



Fig. 3-v: OEM 3/4" Coolant Hose (Modified)

- W. With the 3/4" OEM coolant hose properly modified, reinstall the protective nylon cover & secure both ends of the hose using the 2x OEM spring clamps.
(See Fig. 3-w)



Fig. 3-w: Secure Modified OEM 3/4" Coolant Hose

- X. The OEM molded coolant hose on the driver side of the radiator will need to tee into the upper OEM molded radiator hose. Measure 5" back from the coolant tank end of the upper OEM molded coolant hose & cut. Slide a 18.5 stepless clamp onto each end of the hose, then place the provided 3/8" plastic tee in between the hose, making sure that the open end of the tee is pointing towards the bottom of the vehicle. Once in position, secure the tee using the previously installed 18.5 stepless clamps.
(See Fig. 3-x)



Fig. 3-x: Secure 3/8" Plastic Tee

3. ENGINE COOLING SYSTEM MODIFICATON, cont'd

- Y. Locate the OEM molded coolant hose on the driver side of the radiator & attach it to the remaining open end of the 3/8" tee that was previously installed in Step Q. Secure using the OEM spring clamp. At this point, proceed to refill your coolant system. Be sure to only fill the coolant tank about half way, leaving enough space in the tank to allow for coolant expansion. The half way mark is the point where the narrow section of the tank expands to the wider upper section. To aid in refilling the cooling system, periodically squeeze the larger upper & lower radiator hoses. This helps circulate the coolant within the cooling system. Be sure not to overfill the coolant tank.

(See Fig. 3-y)

NOTE: Periodically check the coolant level once the car is running & the cooling system purges.



Fig. 3-y: Refill Cooling System

This page was left intentionally blank.

4. DISCHARGE TUBE ASSEMBLY & CHARGE AIR COOLER INSTALLATION

- A. Locate the supplied .80" black anodized aluminum throttle body spacer & 1/8" NPT hose barb fitting. Install the 1/8" NPT fitting into the port of the throttle body spacer as shown. Be sure to use pipe sealant on the threads of the 1/8" NPT fitting.

(See Fig. 4-a)



Fig. 4-a: Install 1/8" NPT Fitting

- B. Locate the supplied .80" black anodized aluminum throttle body spacer. Install the included large o-ring into the groove in the spacer. This o-ring seals against the throttle body & the smooth side of the spacer seals against the OEM o-ring in the intake manifold. If you used a rag to temporarily cover the intake manifold opening, remove it at this time. Check the o-ring for any damage. If all looks well, clean the throttle body mounting surface of any foreign debris, then proceed to install the throttle body spacer using the supplied 4x M6 x 30mm button head cap screws. Make sure to point the 1/8" NPT fitting towards the top of the vehicle.

(See Fig. 4-b)



Fig. 4-b: Install Throttle Body Spacer

- C. Locate the previously removed throttle body. With the electrical connector on the throttle body pointed towards the top of the vehicle, align the 4x mounting holes with the 4x offset threaded holes on the throttle body spacer. Use the OEM throttle body screws to secure the throttle body to the throttle body spacer. Ensure that both o-ring seals stay in place. Carefully snip the strip of tape securing the throttle body electrical harness to the connector housing. Reconnect the connector to the throttle body. Make sure the throttle body electrical harness & any other items are routed away from moving parts and sharp edges and secure.

(See Fig. 4-c)



Fig. 4-c: Reinstall Throttle Body

4. DISCHARGE TUBE ASSEMBLY & CHARGE AIR COOLER INSTALLATION, cont'd

- D. In order to provide adequate space for the discharge tubes, the windshield washer fluid reservoir will need to be slightly relocated. Place a clean drain pan underneath the windshield washer fluid reservoir, then proceed to remove the windshield washer fluid pump from the windshield washer fluid reservoir, allowing the windshield washer fluid to drain. Set the windshield washer fluid pump aside as it does not need to be reinstalled at this time.

(See Fig. 4-d)



Fig. 4-d: Drain Windshield Washer Fluid Reservoir

- E. There are a series of electrical harnesses & a windshield washer fluid line attached to the windshield washer reservoir, which need to be detached. Proceed to detach them at this time.

(See Fig. 4-e)



Fig. 4-e: Detach Electrical Harnesses & Windshield Washer Fluid Line

- F. Disconnect the windshield washer fluid level sensor at this time.

(See Fig. 4-f)

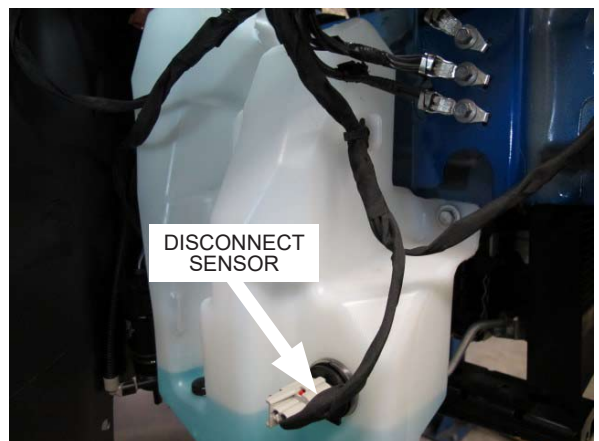

Fig. 4-f: Disconnect Windshield Washer Fluid Level Sensor

4. DISCHARGE TUBE ASSEMBLY & CHARGE AIR COOLER INSTALLATION, cont'd

- G. There are 3x 10mm-headed fasteners securing the windshield washer fluid reservoir to the vehicle. Remove the fasteners, then proceed to remove the windshield washer fluid reservoir. Set the 3x fasteners aside.

(See Fig. 4-g)

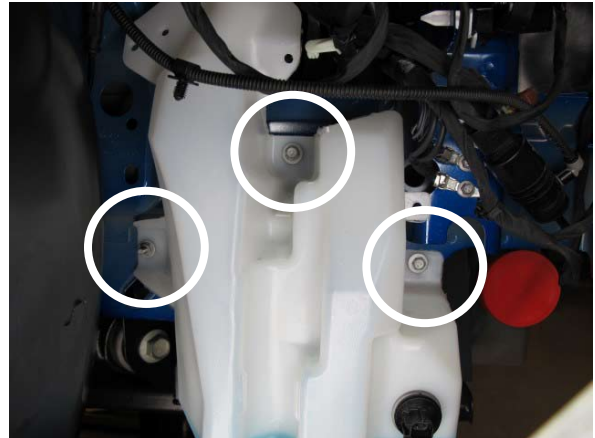

Fig. 4-g: Remove Windshield Washer Fluid Reservoir

- H. There is a tab on the right side of the windshield washer fluid reservoir that needs to be modified. Draw a straight line to the left of the electrical harness mounting hole, then proceed to cut that section off.

(See Fig. 4-h)

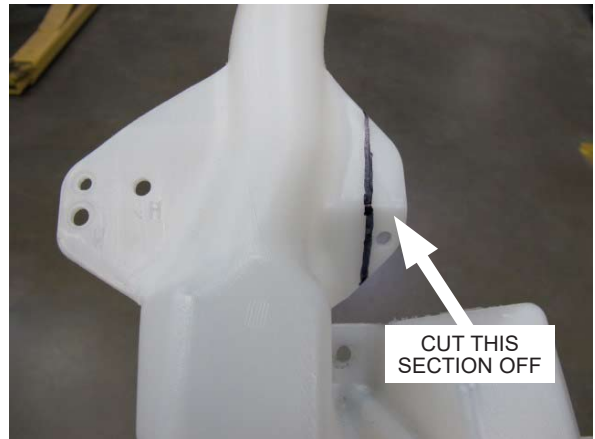

Fig. 4-h: Modify Windshield Washer Fluid Reservoir

- I. Locate the fuse box on the passenger side of the vehicle. On the front-left side of the fuse box is a tie wrap that secures a part of the main harness to a plastic guard. Cut off the tie wrap at this time as the harness will be slightly repositioned. It may be necessary to remove some of the tape from the harness to allow for more movement.

(See Fig. 4-i)



Fig. 4-i: Remove Harness Tie Wrap

4. DISCHARGE TUBE ASSEMBLY & CHARGE AIR COOLER INSTALLATION, cont'd

- J. There is a steel bracket located along side the ECU harness connectors. To prevent possible damage to the harness that runs along side of the steel bracket, be sure to route the harness on top of the steel bracket..

(See Fig. 4-j)

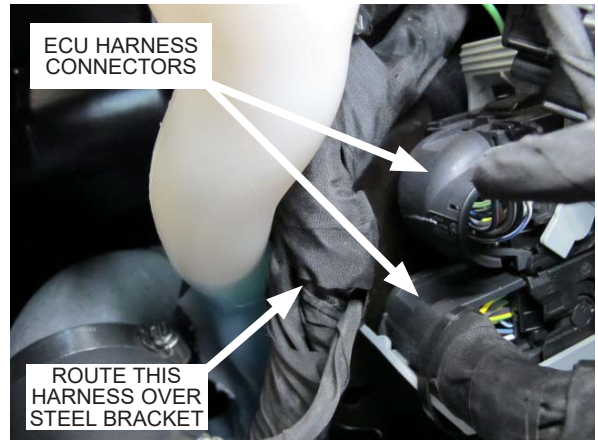

Fig. 4-j: Route Harness As Shown

- K. Reinstall the windshield washer fluid reservoir, making sure that the harness runs behind the filler neck. This is done in order to provide space for the provided discharge tubes that will be installed in a later step. Secure using the 3x OEM 10mm-headed fasteners.

(See Fig. 4-k)



Fig. 4-k: Reinstall Windshield Washer Fluid Reservoir

- L. Reinstall the windshield washer fluid pump & reconnect the windshield washer fluid level sensor. The only harnesses that should be routed in front of the windshield washer fluid reservoir are that of the windshield washer fluid pump, windshield washer fluid sensor & the harness for the headlight connector. Reattach the electrical connector & windshield washer fluid line to their original location on the left side of the windshield washer fluid reservoir.

(See Fig. 4-l)



Fig. 4-l: Reinstall Windshield Washer Fluid Pump & Windshield Washer Fluid Level Sensor

4. DISCHARGE TUBE ASSEMBLY & CHARGE AIR COOLER INSTALLATION, cont'd

- M. Detach the cooling fan connector from the fan shroud. Push the connector towards the bottom of the vehicle, making sure to leave it connected. This is done in order to provide space for the provided discharge tubes that will be installed in a later step
(See Fig. 4-m)



Fig. 4-m: Detach Cooling Fan Connector From Fan Shroud

- N. **Performance-Pack Vehicles Only:** There is an unused plug for the active grille shutters located behind the front bumper support. Remove the plug from the front bumper support at this time. It will be relocated in a later step.
(See Fig. 4-n)



Fig. 4-n: Remove Unused Plug From Front Bumper Support

- O. You will notice a wire harness running along the rear of the front bumper support secured by 3x gray clips. Free the harness from the front bumper support.
(See Fig. 4-o)

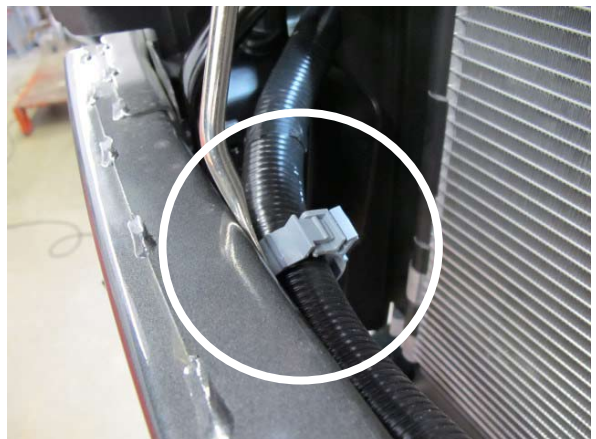

Fig. 4-o: Detach Wire Harness

4. DISCHARGE TUBE ASSEMBLY & CHARGE AIR COOLER INSTALLATION, cont'd

- P. Remove the gray clips from the wire harness discard them. They will not be reused.
(See Fig. 4-p)



Fig. 4-p: Remove Gray Wire Harness Clips

- Q. Part of the harness that runs along the rear of the front bumper support is secured to one of the front bumper support screws by a black plastic harness retainer. Remove the retainer from the screw & cut off the retainer from the harness.
(See Fig. 4-q)



Fig. 4-q: Remove Plastic Harness Clip

- R. **Performance-Pack Vehicles Only:** There are 2x plastic fasteners securing the lower radiator shroud to the driver & passenger side radiator shrouds. Pop the center section of each plastic fastener upward and then the larger part of the fastener will loosen. Discard the 2x fasteners & the lower radiator shroud as they will not be reused.
(See Fig. 4-r)

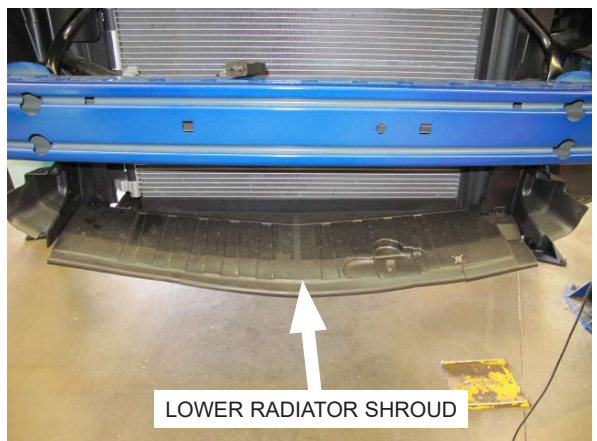

Fig. 4-r: Remove Lower Radiator Shroud

4. DISCHARGE TUBE ASSEMBLY & CHARGE AIR COOLER INSTALLATION, cont'd

- S. **Performance-Pack Vehicles Only:** There are 6x plastic fasteners securing the upper radiator shroud to the upper radiator support. Simply pull down on the upper radiator shroud to release the fasteners from the upper radiator support. Set the upper radiator shroud aside for modification in a later step.

(See Fig. 4-s)

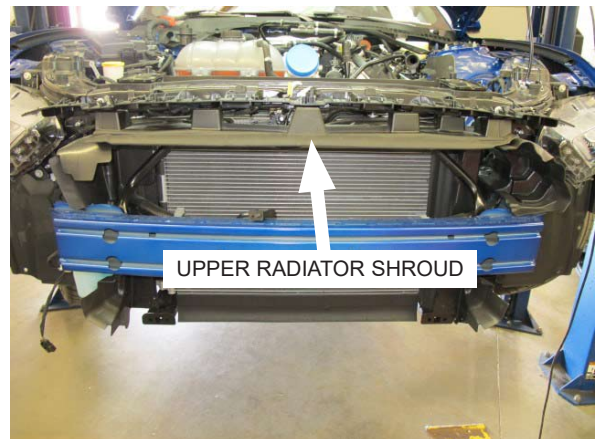

Fig. 4-s: Remove Upper Radiator Shroud

- T. Remove the 4x 13mm-headed fasteners securing the front braces to the upper radiator support & front bumper support, then proceed to remove the front braces from the vehicle.

(See Fig. 4-t)

NOTE: Certain base-model vehicles do not come equipped with the optional front braces.

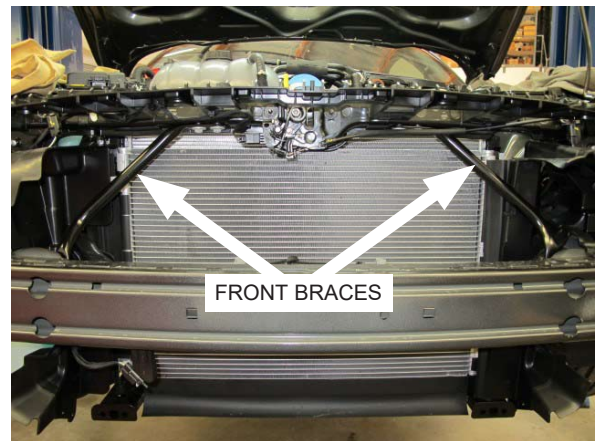

Fig. 4-t: Remove Front Braces

- U. Remove the driver & passenger side radiator shroud. Each radiator shroud is held in place by a plastic fastener. Simply pull each radiator shroud away from the vehicle to release the plastic fastener. Set each radiator shroud aside for modification in a later step.

(See Fig. 4-u)

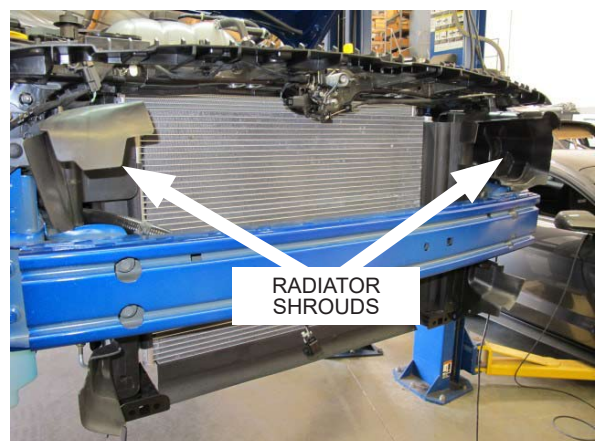

Fig. 4-u: Remove Radiator Shrouds

4. DISCHARGE TUBE ASSEMBLY & CHARGE AIR COOLER INSTALLATION, cont'd

- V. Remove the shroud that's located on the driver side of the A/C condenser & set aside. It will not be reused.

(See Fig. 4-v)

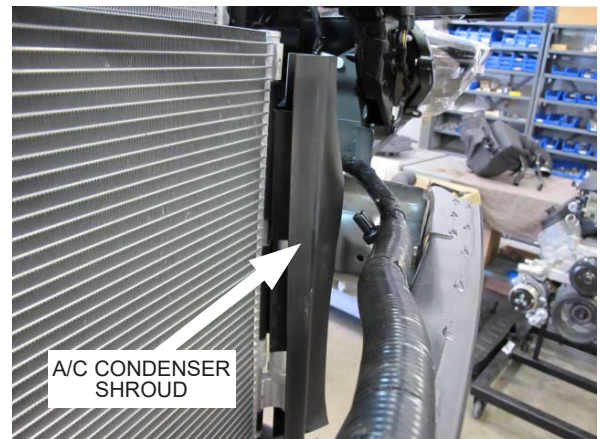

Fig. 4-v: Remove A/C Condenser Shroud

- W. Prior to installing the provided charge air cooler, the driver & passenger side radiator shrouds will need to be modified as shown.

(See Fig. 4-w)



Fig. 4-w: Modify Radiator Shrouds

- X. Back out the 4x innermost screws of the front bumper support, leaving about 1/2" of the screw protruding from the back side. Raise the charge air cooler into position, making sure to align the charge air cooler brackets to the 4x screws previously backed out. Once aligned, begin to thread the screws through the charge air cooler brackets. Route the wire harness along the top side of the front bumper support. Attach the ambient air temperature sensor back into its original location & plug in its electrical connector.

(See Fig. 4-x)



Fig. 4-x: Charge Air Cooler Installation

4. DISCHARGE TUBE ASSEMBLY & CHARGE AIR COOLER INSTALLATION, cont'd

- Y. If your vehicle is not equipped with the front braces, proceed to install the charge air cooler against the bumper support, then secure with the provided M8 x 1.25 flanged nuts & 5/16 washers. For vehicles equipped with the front braces, reuse the factory hardware, making sure the charge air cooler brackets are sandwiched between the lower brace mounts & front bumper support.

(See Fig. 4-y)



Fig. 4-y: Secure Charge Air Cooler

- Z. **Performance-Pack Vehicles Only:** Locate the unused active grille shutter plug that was originally installed behind the front bumper support & remove the white plug fastener. It will not be reused.

(See Fig. 4-z)



Fig. 4-z: Remove Plug Retainer

- AA. **Performance-Pack Vehicles:** Using a tie wrap, secure the unused active grille shutter plug to the large harness, making sure that the plug is either on top or in front of the harness.

(See Fig. 4-aa)

Base-Model Vehicles: Wrap the end of the active grille shutter plug with electrical tape. This is done to keep foreign debris from entering the plug. Using a tie wrap, secure the active grille shutter plug to the large harness, making sure that the plug is either on top or in front of the harness.



Fig. 4-aa: Secure Plug To Harness

4. DISCHARGE TUBE ASSEMBLY & CHARGE AIR COOLER INSTALLATION, cont'd

- AB. **Performance-Pack Vehicles Only:** Since the radiator assembly is now tilted forward, it will be necessary to modify the center section of the previously removed upper radiator shroud. Measure 1" inward from the flat edge of the upper radiator. Draw a cut line using a marker or a piece of tape, then proceed to cut off the center section only. Use Fig. 4-aj as reference. (See Fig. 4-ab)

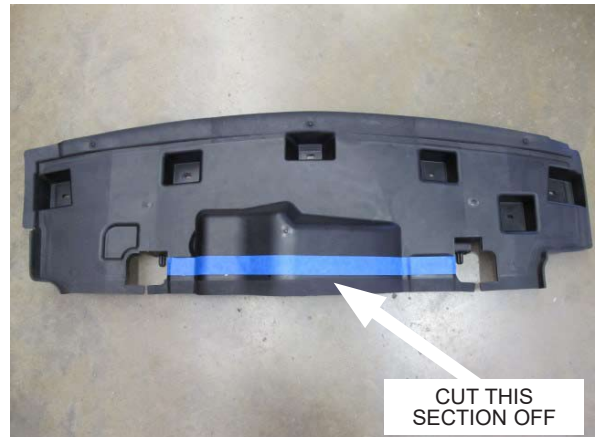

Fig. 4-ab: Modify Upper Radiator Shroud

- AC. **Performance-Pack Vehicles Only:** With the upper radiator shroud modified, proceed to reinstall it to the vehicle & secure using the appropriate OEM plastic fasteners. (See Fig. 4-ac)

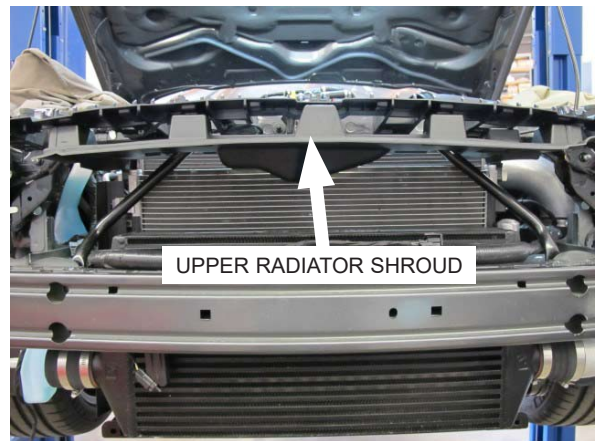

Fig. 4-ac: Reinstall Upper Radiator Shroud

- AD. Located on the driver side of the vehicle is the horn assembly. Unplug the horns & remove them from the vehicle. Remove the threaded clip that the horn fastener is attached to & set it aside with the 8mm-headed fastener. They will be reinstalled in a new location in a later step. (See Fig. 4-ad)



Fig. 4-ad: Remove Horn Assembly

4. DISCHARGE TUBE ASSEMBLY & CHARGE AIR COOLER INSTALLATION, cont'd

AE. **Automatic Transmission Vehicles:** There are a set of transmission cooler lines that run along the passenger side of the engine towards a heat exchanger near the front of the vehicle. Because they are routed near the space where discharge tube A will be installed, the transmission cooler lines need to be moved away from the engine. Located on the passenger side engine mount is a transmission cooler line bracket. Remove the nut that secures the transmission cooler line bracket to the engine mount. Using the provided .430" spacer & place it in between the transmission cooler line bracket & the engine mount, then resecure using the previously removed nut.

(See Fig. 4-ae)

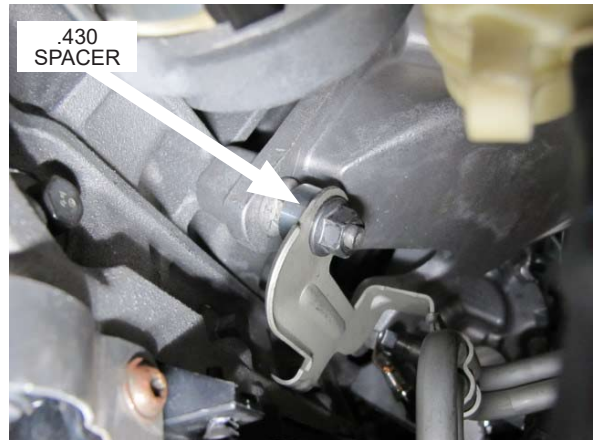

Fig. 4-ae: Install A/T Cooler Line Spacer

AF. You will notice that one of the A/C line is in the path of where discharge tube A will be. In order to provide adequate space, bend the A/C line in towards the fan shroud. Do this in small steps in order to avoid damaging the A/C line.

(See Fig. 4-af)

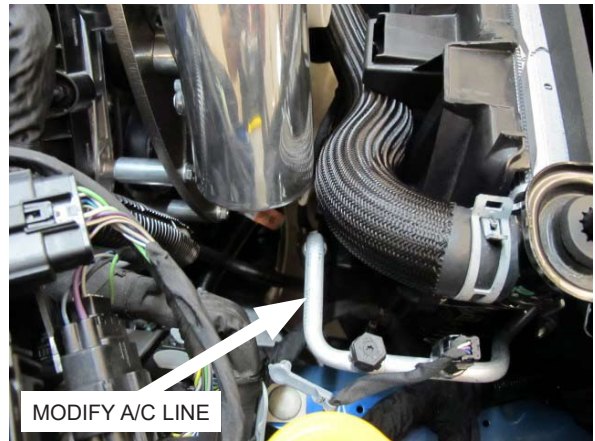

Fig. 4-af: Modify A/C Line

AG. **Manual Transmission Vehicles:** Locate the provided bypass valve & install it onto discharge tube A as shown, making sure to use the provided gasket between the bypass valve & the mounting flange. Secure using the provided 2x 1/4-20" x .75 socket head cap screws.

(See Fig. 4-ag)



Fig. 4-ag: Install Bypass Valve (Manual Transmission Vehicles)

4. DISCHARGE TUBE ASSEMBLY & CHARGE AIR COOLER INSTALLATION, cont'd

- AH **Automatic Transmission Vehicles:** Locate the provided bypass valve & install it onto discharge tube A as shown, making sure to use the provided gasket between the bypass valve & the mounting flange. Secure using the provided 2x 1/4-20" x .75 socket head cap screws.
(See Fig. 4-ah)



Fig. 4-ah: Install Bypass Valve
(Automatic Transmission Vehicles)

- AI. Position discharge tube A as shown without the silicone sleeves. The end of the tube with the bypass valve flange will be installed closest to the supercharger. Once the tube is in place, proceed to install the silicone sleeves to the discharge tube as shown. Loosely attach 4x #48 hose clamps to the silicone sleeves.
(See Fig. 4-ai)

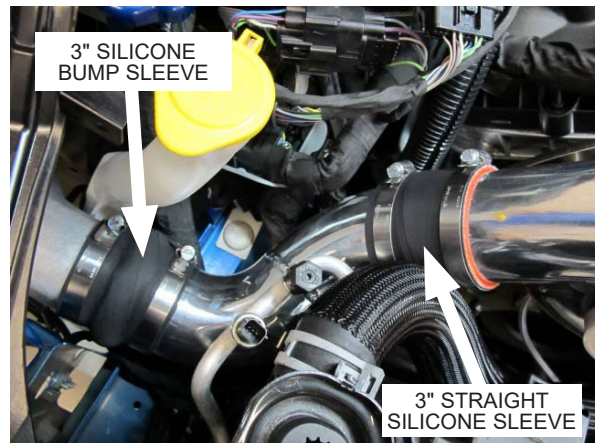

Fig. 4-ai: Install Discharge Tube A

NOTE: To install discharge tube A, it will need to be installed from the underside of the supercharger, between the fan shroud & the supercharger mounting bracket assembly. We suggest wrapping the tube in blue painters tape or a shop rag to avoid scratching the tube. It is also helpful to do this step with the upper radiator brackets removed, as it allows you to pull the radiator assembly forward for added clearance.

- AJ. Loosely attach a straight 3" silicone sleeve & 2x #48 hose clamps to the passenger side of the charge air cooler. The tab that protrudes downward from the front bumper support will need to be bent forward towards the front of the vehicle to provide space for discharge tube B.
(See Fig. 4-aj)



Fig. 4-aj: Install Silicone Sleeve & Hose Clamps

4. DISCHARGE TUBE ASSEMBLY & CHARGE AIR COOLER INSTALLATION, cont'd

AK. Install discharge tube B into the straight 3" silicone sleeve on the charge air cooler & the 3" silicone bump sleeve on discharge tube A. Reinstall the passenger side headlight at this time. Temporarily reinstall the front bumper cover on the vehicle in order to position discharge tube B properly as it is a tight fit behind the passenger side headlight & front bumper cover. Once discharge tube B is in the proper position, proceed to tighten all of the #48 hose clamps on discharge tube A & discharge tube B. Remove the front bumper cover once this step is complete, but leave the headlight installed. Be sure to reconnect the headlight plug & resecure the headlight hardware.

(See Fig. 4-ak)



Fig. 4-ak: Install Discharge Tube B

AL. The harness that the MAF sensor connector is attached to is secured to the vehicle in 2x places as shown in Fig. 4-ar. Remove the harness from these 2x mounting places.

(See Fig. 4-al)

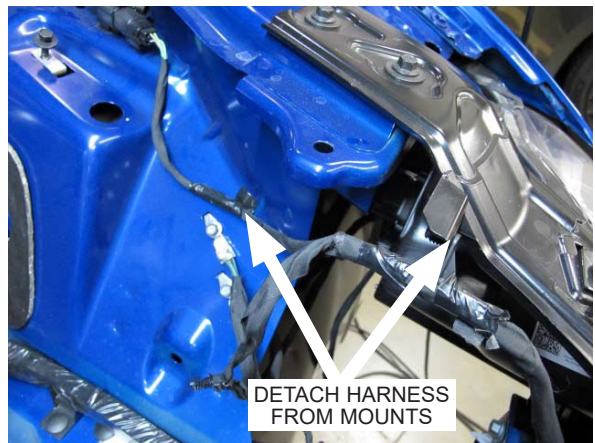

Fig. 4-al: Detach Harness

AM. Loosely attach a 3.5" to 3.0" silicone reducer sleeve, a #48 hose clamp & a #56 hose clamp to the driver side of the charge air cooler. One of the legs of discharge tube C is slightly longer than the other. Install the shorter end of the tube into the silicone reducer sleeve. Loosely install a straight 3.5" silicone sleeve & 2x #56 hose clamps to the other end of discharge tube C. The tab that protrudes downward from the front bumper support will need to be bent forward towards the front of the vehicle to provide space for discharge tube C.

(See Fig. 4-am)



Fig. 4-am: Install Discharge Tube C

4. DISCHARGE TUBE ASSEMBLY & CHARGE AIR COOLER INSTALLATION, cont'd

AN. Install discharge tube D into the straight 3.5" silicone sleeve on discharge tube C. Be sure to route the MAF sensor harness underneath the tube.

(See Fig. 4-an)



Fig. 4-an: Install Discharge Tube D

AO. Locate the provided MAF sensor housing. Remove the MAF sensor from the OEM air box & set the OEM T-20 screws aside for reinstallation in a later step. Insert the MAF sensor into the MAF sensor housing & secure using the provided M4-7 screws. Be sure not to damage the o-ring on the MAF sensor.

(See Fig. 4-ao)

NOTE: The MAF sensor is directional & will only fit into the MAF housing one way.



Fig. 4-ao: Install MAF Sensor To MAF Housing

AP. Locate the provided S-shaped silicone sleeve, 4.0" to 3.5" silicone reducer sleeve & 2x #64 hose clamps & loosely assemble them as shown in Fig. 4-av. There is a "FLOW" arrow on the MAF sensor housing indicating the direction of air flow. When installing the MAF sensor housing to the silicone sleeves, be sure that the flow arrow is pointed towards the S-shaped silicone sleeve.

(See Fig. 4-ap)



Fig. 4-ap: Assemble MAF Sensor Housing & Sleeves As Shown

4. DISCHARGE TUBE ASSEMBLY & CHARGE AIR COOLER INSTALLATION, cont'd

AQ. Install the S-shaped silicone sleeve, MAF sensor housing & 4.0" to 3.5" silicone reducer sleeve onto discharge tube C & the throttle body, loosely securing both ends with 2x #56 hose clamps. The worm gear on the #56 hose clamp closest to discharge tube C will need to be installed so it's closest to the fan shroud. Make sure that the MAF sensor plug is pointed directly towards the engine. With all of the discharge tubes & silicone sleeves in position & free of any obstructions, proceed to tighten all of the hose clamps.

(See Fig. 4-aq)



Fig. 4-aq: Secure All Hose Clamps

AR. Locate the provided 3.5' length of 7/32" vacuum hose. Attach one end of the hose to the vacuum fitting located at the top of the throttle body spacer.

(See Fig. 4-ar)



Fig. 4-ar: Attach Vacuum Hose To 1/4" Fitting

AS. Route the 7/32" vacuum line along the front of the motor & across the front of the supercharger mounting bracket assembly, then attach it to the vacuum fitting on the bypass valve. Making sure that the vacuum hose is free of any obstructions, use the provided 2x 11" length tie wraps to secure the vacuum hose to the upper radiator hose.

(See Fig. 4-as)



Fig. 4-as: Attach Vacuum Hose To Bypass Valve
(M/T Bypass Valve Picture, Same For A/T)

4. DISCHARGE TUBE ASSEMBLY & CHARGE AIR COOLER INSTALLATION, cont'd

- AT. Just to the right of the original mounting location of the horn assembly is a tab with 3x holes. Locate the previously removed OEM threaded clip & attach it to the lowest hole on the tab. (See Fig. 4-at)



Fig. 4-at: Relocate OEM Threaded Clip

- AU. Locate the OEM horn assembly & install it as shown, securing it with the previously removed OEM 8mm-headed fastener. Loosen the 10mm-headed fastener securing the horn closest to the bottom of the vehicle. Rotate the horn clockwise so the horn plug is pointed towards the top of the vehicle, then resecure the 10mm-headed fastener. Once in position, reconnect the horn connector to the horn assembly. (See Fig. 4-au)



Fig. 4-au: Install Horn Assembly

- AV. With the discharge tubes in position, proceed to secure the upper radiator brackets using the provided M6 x 22mm socket head cap screws in place of the OEM 10mm-headed screws. (See Fig. 4-av)

NOTE: In some instances, we have seen that the A/C condenser isn't fully seated to its mounts. Since the modified upper radiator mounts will cause the radiator assembly to be tilted forward, it's necessary to check that the top of the A/C condenser doesn't come into contact with the underside of the hood latch mechanism. Adjust the A/C condenser as necessary.



Fig. 4-av: Reinstall Modified Upper Radiator Brackets

5. FUEL INJECTOR REPLACEMENT

- A. Remove the 4x 10mm-headed fasteners securing the plastic heater hose guides. Set the passenger side guide aside for later reinstallation. Reposition the vacuum tube assembly mounted along the driver side heater hose guide to allow room for fuel rail removal. (See Fig. 5-a)



Fig. 5-a: Remove Fuel Injector Rail Fasteners

- B. The driver side plastic heater hose guide has an EVAP solenoid attached to it. Leave the heater hose guide in the vehicle & reposition it to allow room for fuel rail removal. (See Fig. 5-b)



Fig. 5-b: Set Driver Side Heater Hose Guide Aside

- C. Remove the foam insulation from each fuel rail & set them aside. The passenger side foam insulation will be modified in a later step. (See Fig. 5-c)

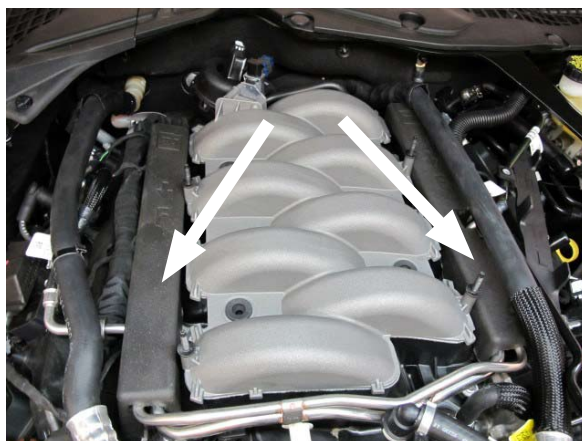

Fig. 5-c: Remove Fuel Injector Foam Insulation

5. FUEL INJECTOR REPLACEMENT, cont'd

- D. Unplug each of the 8x fuel injector electrical connectors.
(See Fig. 5-d)



Fig. 5-d: Disconnect Fuel Injectors

- E. Unplug the fuel rail pressure sensor connector, located on the driver side fuel rail.
(See Fig. 5-e)



Fig. 5-e: Disconnect Fuel Rail Pressure Sensor

- F. Detach the low pressure fuel feed line from the driver side fuel rail. To release the fuel feed line, pull back on the green tabs on the quick disconnect fitting, then push them down. Place a rag under the fuel feed line to catch any fuel that may spill.
(See Fig. 5-f)



Fig. 5-f: Disconnect Low Pressure Fuel Feed Line

5. FUEL INJECTOR REPLACEMENT, cont'd

- G. Using a 3/8" fuel line quick disconnect tool, detach the direct injection fuel line from the passenger side of the fuel rail. Place a rag under the fuel line to catch any fuel that may spill. Proceed to remove the fuel rail assembly from the vehicle.
(See Fig. 5-g)



Fig. 5-g: Disconnect Direct Injection Fuel Line

- H. Remove the 4x 10mm-headed screws securing the fuel rails to the intake manifold. Lift the fuel rails up & away from the engine. Drain the fuel from the rails.
(See Fig. 5-h)



Fig. 5-h: Remove Fuel Rail Assembly

- I. Note the orientation of the OEM injectors in the fuel rails. Remove the retaining clips & remove the OEM injectors. 2x supplied fuel injectors will be oriented differently than OEM. This will be covered in Step 5-j & 5-k.
(See Fig. 5-i)



Fig. 5-i: Make Note Of Fuel Injector Orientation

5. FUEL INJECTOR REPLACEMENT, cont'd

- J. On the driver side fuel rail, the fuel injector that is furthest from the fuel rail pressure sensor will need to be rotated 90° clockwise from its original position. Leave the retaining clip for that injector off at this time. Install the rest of the driver side fuel rail injectors in their original position & secure with the retaining clips at this time.

(See Fig. 5-j)

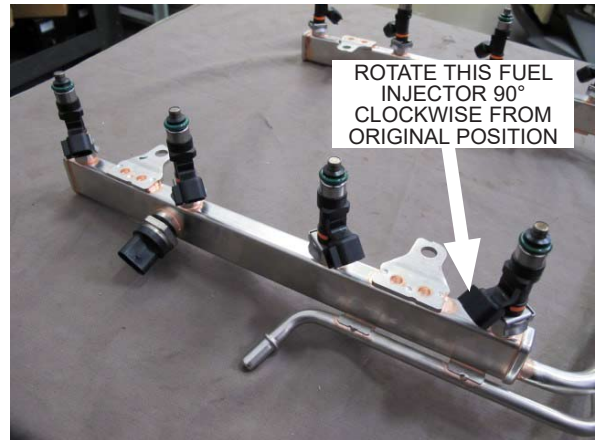

Fig. 5-j: Rotate Fuel Injector 90° Clockwise

- K. On the passenger side fuel rail, the fuel injector that is furthest from the direct injection fuel feed line will need to be rotated 90° clockwise from its original position. Leave the retaining clip for that injector off at this time. Install the rest of the passenger side fuel rail injectors in their original position & secure with the retaining clips at this time.

(See Fig. 5-k)

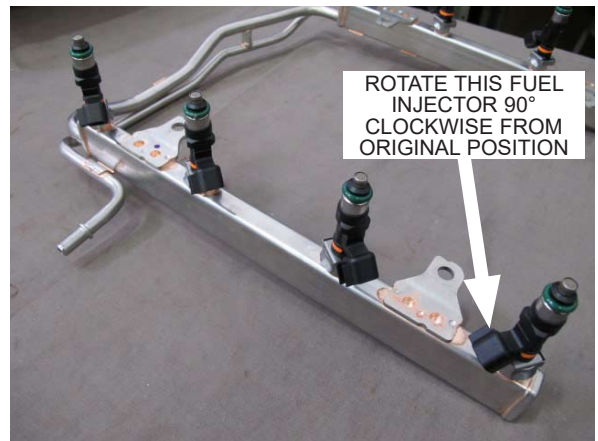

Fig. 5-k: Rotate Fuel Injector 90° Clockwise

- L. The retaining clips that secure the 2x fuel injectors that are rotated 90° need to be installed as shown. Failure to do so may result in improper fuel injector fitment for these 2x injectors.

(See Fig. 5-l)

NOTE: The retaining clip must be installed in the exact orientation for proper fuel injector fitment. However, if you still encounter a fitment issue, it may be necessary to leave the retaining clip off of the 2x injectors that are rotated 90° from their original location.

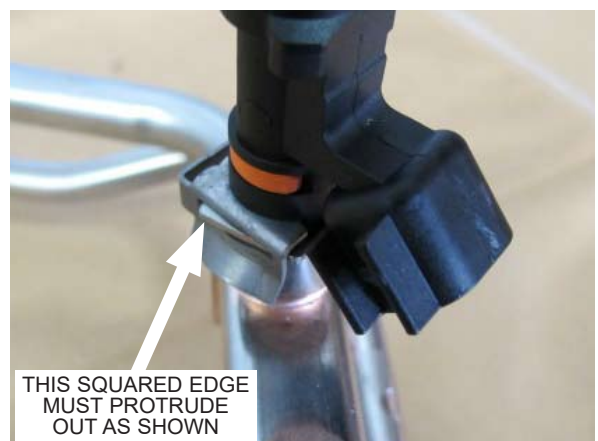

Fig. 5-l: Clock Fuel Rail Retaining Clip As Shown

5. FUEL INJECTOR REPLACEMENT, cont'd

- M. Locate the passenger side fuel rail cover. On the outer edge near the "R" stamp, measure & cut a 1" square. This is done to allow clearance for one of the fuel injector connectors. (See Fig. 5-m)



Fig. 5-m: Modify Passenger Side Fuel Rail Cover

- N. Locate the 4x OEM aluminum fuel rail spacers that are lightly pressed into the intake manifold. Using a pair of pliers, pull them free & replace them with the supplied shorter fuel rail spacers. (See Fig. 5-n)

NOTE: In some cases, it will be difficult to remove the fuel rail spacers. If this is the case, we suggest rotating the fuel rail spacers while simultaneously pulling them upward.



Fig. 5-n: Install Provided Fuel Rail Spacers

- O. Install the fuel rail/injector assembly into the intake manifold. Secure the fuel rails with the provided 4x M6 x 90mm socket head cap screws & 4x M6 washers. Reconnect all fuel lines, fuel rail pressure sensor & fuel injectors at this time, then proceed to reinstall all fuel rail insulators, heater hose guides & remaining fasteners. (See Fig. 5-o)



Fig. 5-o: Secure Fuel Rail Assembly

This page was left intentionally blank.

6. FUEL PUMP BOOSTER INSTALLATION

NOTE: The provided mounting bracket for the fuel pump booster is not compatible with convertible vehicles at this time. Please consult your local fabricator for a custom solution.

- A. In order to access the fuel pump driver module, it will be necessary to remove the lower rear seat cushion. There are 2x retainers located underneath the front bolsters that secure the lower rear seat cushion to the vehicle.

(See Fig. 6-a)



Fig. 6-a: Rear Seat Retainer Location

- B. In order to release the lower rear seat cushion from the vehicle, press the retainer lever inwards then pull the lower rear seat cushion upwards.

(See Fig. 6-b)



Fig. 6-b: Rear Seat Retainer

- C. Located near the driver side rear interior panel is the fuel pump driver module. Unplug the electrical connector at this time.

(See Fig. 6-c)

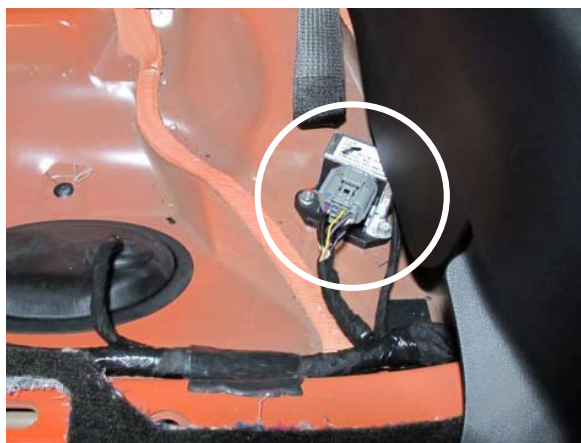

Fig. 6-c: Unplug Fuel Pump Driver Module

6. FUEL PUMP BOOSTER INSTALLATION, cont'd

- D. Locate the upper rear seat release strap & fold the upper rear seat down.
(See Fig. 6-d)



Fig. 6-d: Fold Upper Rear Seat Down

- E. Detach the rear seatbelt guide from the driver side rear interior panel. The seatbelt passes through the rear seatbelt guide, so it can remain in the vehicle.
(See Fig. 6-e)



Fig. 6-e: Detach Small Plastic Trim

- F. Remove the interior panel directly above the driver side door sill by pulling it upwards, releasing the retainer clips.
(See Fig. 6-f)



Fig. 6-f: Remove Interior Panel Above Driver Side Door Sill

6. FUEL PUMP BOOSTER INSTALLATION, cont'd

- G. The driver side rear interior panel needs to be removed. To remove, pull from the top of the panel & pull away from the window. Work your way around the panel to release all of the retaining clips.
(See Fig. 6-g)



Fig. 6-g: Remove Driver Side Rear Interior Panel

- H. Locate the driver side rear interior panel & lay it down as shown. There is a foam insulation block that needs to be removed to make space for the fuel pump booster.
(See Fig. 6-h)



Fig. 6-h: Foam Insulation Block

- I. Remove the 2x metal clips securing the insulation block. Discard the insulation block & 2x metal clips as they will not be reused.
(See Fig. 6-i)



Fig. 6-i: Remove Foam Insulation Block

6. FUEL PUMP BOOSTER INSTALLATION, cont'd

- J. Located near the driver side seatbelt assembly is a flat surface where the fuel pump booster will be mounted.

(See Fig. 6-j)



Fig. 6-j: Fuel Pump Booster Mounting Location

- K. Locate the fuel pump booster mounting plate & use it as a template to mark your drill holes. Align the edge of the fuel pump booster mounting plate with the edge of the flat mounting surface. Mark the 2x mounting holes, then center punch the marks. Using a #4 drill bit, drill out the 2x mounting hole marks. Be sure to use a sharp drill bit.

(See Fig. 6-k)

NOTE: Although a #4 drill bit is optimal for this step, you can substitute it with a 7/32" drill bit if necessary.

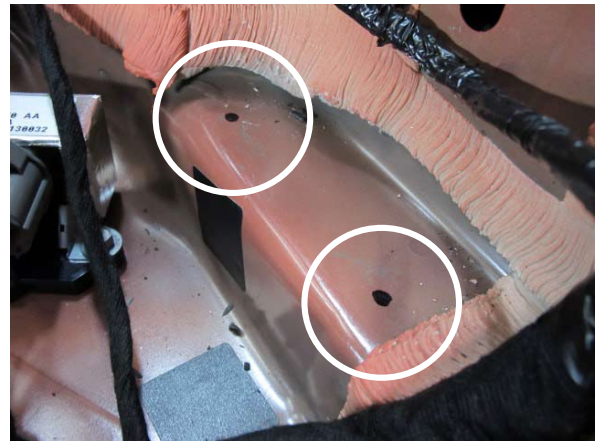

Fig. 6-k: Mark & Drill Mounting Holes

- L. Attach the fuel pump booster to the mounting plate using the supplied 4x 10-24 x .50 socket head screws, 4x 10-24 nylock nuts & 4x #10 flat washers. Install the assembly to the vehicle & secure using the provided 2x #14 hex head self-tapping screws.

(See Fig. 6-l)



Fig. 6-l: Mount Fuel Pump Booster

6. FUEL PUMP BOOSTER INSTALLATION, cont'd

- M. Locate the provided fuel pump booster adapter harness & install it in-line between the OEM fuel pump driver module & main vehicle harness. Connect the fuel pump booster to the fuel pump booster adapter harness. Take the factory plug & tuck it behind the main harness, making sure that the plug ends up under the fuel pump booster.
(See Fig. 6-m)



Fig. 6-m: Install Adapter Harness

- N. The brown wire on this fuel pump booster will not be used. Tape the open end of the wire shut, then tape it to the black ground wire.
(See Fig. 6-n)



Fig. 6-n: Brown Wire
(Unused)

- O. Using an 8mm socket, remove the ground screw located on the driver side 'B' pillar. Locate the black ground wire with the ring terminal from the fuel pump booster and ground it as shown. Resecure using the previously removed screw.
(See Fig. 6-o)

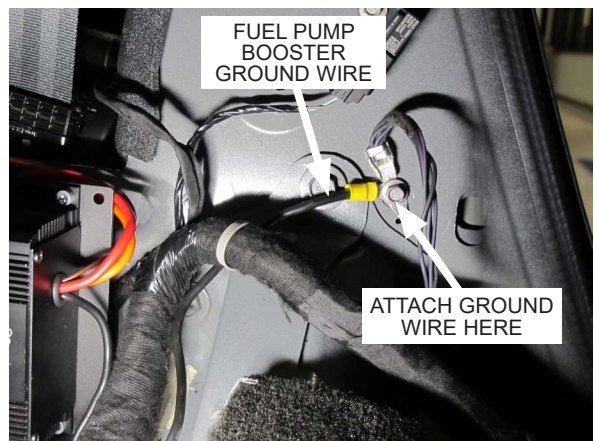

Fig. 6-o: Attach Fuel Pump Booster Ground Strap

6. FUEL PUMP BOOSTER INSTALLATION, cont'd

- P. Reinstall the driver side rear interior panel. Reinstall the rear seatbelt guide to the driver side rear interior panel. Test fit the lower rear seat cushion & check clearance between the underside of the rear seat cushion & the adapter harness. If all clears, reinstall the lower rear seat cushion.
(See Fig. 6-p)



Fig. 6-p: Reinstall Driver Side Rear Interior Panel

- Q. Reinstall the interior panel directly above the driver side door sill. Once all panels are re-installed, proceed to reconnect the battery.
(See Fig. 6-q)



Fig. 6-q: Reinstall Interior Panel Above Driver Side Door Sill

7. PCV MODIFICATION & AIR INLET ASSEMBLY INSTALLATION

- A. Locate the passenger side hard plastic PCV tube. Both quick-release fittings need to be removed from the plastic tube. Use a razor blade to carefully slit each end of the plastic tube until it can be split away from the barbed fittings inside. Take care not to damage the fittings.

(See Fig. 7-a)



Fig. 7-a: Remove Both Quick-Release Fittings

- B. Locate the driver side hard plastic PCV tube. The 45° quick-release fitting needs to be removed from the plastic tube. Use a razor blade to carefully slit the plastic tube until it can be split away from the barbed fitting inside. Be sure not to damage the fitting.

(See Fig. 7-b)



Fig. 7-b: Remove 45° Quick-Release Fitting

- C. Locate the provided lengths of 5/8" hose & 3/8" hose. Cut 3x pieces of 5/8" hose to 2" lengths & 1x piece 3/8" hose to 4" length. Using the provided check valve, brass 5/8" to 3/8" reducer, 2x #17 stepless clamps, a #25.6 stepless clamp & a #28.6 stepless clamp, assemble the straight section of the PCV assembly as shown. Secure the stepless clamps at this time. The 2x OEM quick-release fittings & 5/8" x 90° plastic elbow are shown for reference as they will be installed in a later step.

(See Fig. 7-c)



Fig. 7-c: Assemble Straight Section Of PCV Assembly

7. PCV MODIFICATION & AIR INLET ASSEMBLY INSTALLATION, cont'd

- D. Locate the provided flex braid sleeve & heat shrink tubing. Slide the flex braid sleeve over the straight section of the PCV assembly & cut to the proper length. Next, cut the heat shrink tubing into 2x pieces that are roughly 1" in length & use to secure the flex braid sleeve in place, then use a heat gun to shrink the heat shrink tubing. Next, loosely install the OEM 45° quick-release fitting & a #25.6 stepless clamp to the brass side of the PCV assembly, then install the 5/8" x 90° plastic elbow, 3x #25.6 stepless clamps, 1x OEM 90° quick-release fitting & the remaining length of 2" 5/8" hose to the check valve side of the PCV assembly.

(See Fig. 7-d)



Fig. 7-d: Loosely Assemble OEM Quick-Release Fittings As Shown

- E. Temporarily install & position the loosely assembled PCV assembly to the vehicle, making sure that the check valve is closest to the valve cover. With the PCV assembly in position, remove it from the vehicle & proceed to secure all remaining stepless clamps. Reinstall it onto the vehicle once complete.

(See Fig. 7-e)



Fig. 7-e: Install PCV Assembly

- F. Locate the provided MAF block-off plate & 6mm washers. Using the OEM T-20 screws, secure the MAF block-off plate onto the OEM air box.

(See Fig. 7-f)



Fig. 7-f: Install MAF Block-Off Plate

7. PCV MODIFICATION & AIR INLET ASSEMBLY INSTALLATION, cont'd

- G. Temporarily install the OEM air box & check for clearance next to the previously installed coolant tank. It may be necessary to trim near one of the air box latches.
(See Fig. 7-g)



Fig. 7-g: Trim Air Box As Necessary

- H. Remove the air box lid & replace the OEM air filter with the provided air filter, then proceed to secure the OEM air box onto the vehicle using the OEM 10mm-headed fastener.
(See Fig. 7-h)



Fig. 7-h: Install Provided Air Filter & Secure OEM Air Box

- I. Cut an 18" length of 5/8" hose. Install the remaining OEM 90° quick-release fitting on one end of the hose & secure using a #25.6 stepless clamp. Attach the quick-release fitting to its OEM location, then route the other end of the hose towards the front of the vehicle as it will be attached to the provided air inlet in a later step.
(See Fig. 7-i)



Fig. 7-i: Attach Breather Hose To Air Inlet

7. PCV MODIFICATION & AIR INLET ASSEMBLY INSTALLATION, cont'd

- J. There is a hose & quick-release fitting coming off of the OEM check valve assembly located above the throttle body. Remove this hose as it will not be reused.
(See Fig. 7-j)

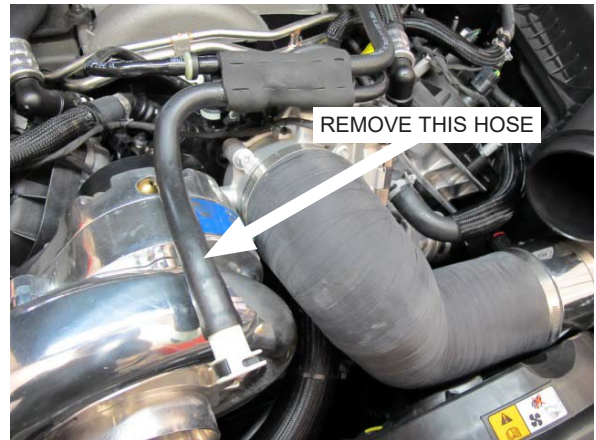

Fig. 7-j: Remove Hose & Quick-Release Fitting

- K. Cut a 24" length of 3/8" hose & attach it where the previously removed OEM hose was attached. Next, route the hose around the back side of the throttle body & over towards the air inlet tube.
(See Fig. 7-k)



Fig. 7-k: Install 24" Length Of 3/8" Hose

- L. Locate the provided 4.25" to 4.0" silicone bump reducer sleeve, 4.0" straight silicone sleeve & 4x #64 hose clamps. Install the silicone reducer sleeve to the air box & the straight silicone sleeve to the supercharger inlet. Loosely attach the 4x #64 hose clamps to the sleeves, then install the provided air inlet tube. Do not secure the hose clamps at this time.
(See Fig. 7-l)



Fig. 7-l: Loosely Install Air Inlet Tube

7. PCV MODIFICATION & AIR INLET ASSEMBLY INSTALLATION, cont'd

- M. On the air inlet tube, attach the 3/8" hose to the 3/8" barbed fitting & the 5/8" hose to the 5/8" barbed fitting. Secure the 5/8" hose using a #25.6 stepless clamp. The 3/8" hose doesn't require any clamps. With the hoses installed & the air inlet tube in position, proceed to tighten the 4x #64 hose clamps to secure the air inlet tube.

(See Fig. 7-m)



Fig. 7-m: Install 3/8" Hose, Then Secure Air Inlet Tube

- N. Since the radiator assembly has been tilted forward, you will need to modify the upper radiator mounting tabs to allow proper fitment of the upper radiator support cover. Grind down the mounting tabs until they are about level with the rubber bushing on the upper radiator support mounts.

(See Fig. 7-n)



Fig. 7-n: Modify Radiator Mounting Tabs

- O. Test fit the upper radiator support cover & check for clearance. When you reinstall the upper radiator support cover, 2x holes will no longer require the use of plastic push fasteners. Leave these holes empty.

(See Fig. 7-o)



Fig. 7-o: Check Upper Radiator Support Cover

7. PCV MODIFICATION & AIR INLET ASSEMBLY INSTALLATION, cont'd

- P. Reinstall all previously removed panels, engine cover, strut tower brace, front bumper cover & splash guards. Check for proper fitment & clearance during reinstallation. You may reconnect the battery at this time.

(See Fig. 7-p)



Fig. 7-p: Reinstall Necessary Components & Perform Final Check

8. EMISSIONS LABEL INSTALLATION

NOTE: This section applies to 'Complete' super-charger systems that do not have the CARB E.O. number stamped on the supercharger serial tag.

- A. Located underneath the hood to the left side of the hood latch is the "Vehicle Emissions Control Information" label. Clean the surface below the label using a clean rag.

(See Fig. 8-a)



Fig. 8-a: Underside Of Hood

- B. Locate the provided CARB E.O. label & affix it to the hood, directly below the "Vehicle Emissions Control Information" label.

(See Fig. 8-b)



Fig. 8-b: Affix Emissions Label As Shown

This page was left intentionally blank.

9. REFLASH COMPUTER

NOTE: This section applies to **'Complete'** supercharger systems. All others proceed to **Section 10**.

NOTE: The software provided to load the tune to the handheld device is compatible only with Windows 7 and newer based computers and can be found at <https://www.livernoismotorsports.com/downloads>. **The handheld device is sent out without a tune**, so you will need to provide a tune request via email to Livernois Motorsports.

- A. Install Livernois MyCalibrator software on your Windows 7, 8, 8.1, or 10 machine:
1. After install is complete, connect device to PC via supplied USB cable.
 2. The program should connect automatically with the tuner displaying serial number, firmware version number, and will check for updates. Please follow all on-screen prompts and fully complete all updates for MyCalibrator Software and MyCalibrator Touch Tuner before connecting to vehicle.
 3. Complete registration prompt.
- B. Before connecting:
1. Turn off all accessories and unplug any electronic devices from any power or USB ports (A/C, radio, auto lights, etc.).
 2. Set the device on a stable, flat surface.
 3. Do not touch anything until it finishes.
 4. Do not let anyone else approach the vehicle. Do not open the doors and be sure that the radio is in the **'OFF'** position.
 5. Be sure your vehicle's battery is sufficiently charged, otherwise use a battery tender to ensure that the battery doesn't fall below 12 volts.
 6. On vehicles with active cruise control and rain sensing wipers, it is normal for the warning light on top of the dash and the wipers to turn on (unless rain sensing is shut off).
 7. For vehicles with push-button ignition, **KEEP YOUR FOOT OFF THE BRAKE**, then press the start button once to enter **'RUN'** mode. **DO NOT START THE VEHICLE**.
 8. Retrieve the ECU Code / S.W. Code by selecting **'MODULE INFO'** from the main menu.
 9. Record and provide these 2 codes, along with all other items identified in section 'D' on page 66.
- C. Installation:
1. Saving your stock tune file:
 - i. With the device still connected to the OBD-II port, vehicle in run mode, and the engine turned off, select the **'PROGRAM VEHICLE'** option in the main menu and follow the on-screen prompts to read/save your stock tune file. Do not turn off the ignition until the device prompts you to do so.
 2. Sending your stock tune to Livernois Motorsports:
 - i. Connect MyCalibrator Touch to Windows PC.
 - ii. Run MyCalibrator Program.
 - iii. Confirm that the VIN now displays on MyCalibrator Program.
 - iv. Allow program to send stock file to Livernois Motorsports for backup purposes.
 3. Requesting your Vortech Supercharger Tune:
 - i. Email Livernois Motorsports with the items identified in section 'D' below.
 4. Downloading your Tune:
 - i. After receiving your email/communication from Livernois Motorsports stating your tune file is ready, connect MyCalibrator Touch to Windows PC.
 - ii. Run MyCalibrator Program.
 - iii. Allow download process to complete.
 - iv. Confirm program now shows **'VORTECH TUNE'** in addition to the **'STOCK'** file.

9. REFLASH COMPUTER

C. Installation (continued):

5. Installing your Tune:

- i. Turn off all accessories & unplug any electronic devices from any power or USB ports (A/C, radio, auto lights, etc.).
- ii. Set the device on a stable, flat surface.
- iii. Do not touch anything until it finishes.
- iv. Do not let anyone else approach the vehicle. Do not open the doors and be sure that the radio is in the **'OFF'** position.
- v. Be sure your vehicle's battery is sufficiently charged, otherwise use a battery tender to ensure that the battery doesn't fall below 12 volts.
- vi. On vehicles with active cruise control and rain sensing wipers, it is normal for the warning light on top of the dash and the wipers to turn on (unless rain sensing is shut off).
- vii. For vehicles with push-button ignition, **KEEP YOUR FOOT OFF THE BRAKE**, then press the start button once to enter **'RUN'** mode. **DO NOT START THE VEHICLE.**
- viii. Select **'PROGRAM VEHICLE'** option from main menu.
- ix. Select **'PRELOADED TUNES'** option on the tuner.
- x. Touch and drag to select **'VORTECH TUNE'**.
- xi. Confirm **'VORTECH TUNE'** is selected and follow all on screen prompts.

6. After install of tuning:

- i. Check vehicle for any possible fuel leaks, and if none present, start vehicle.
- ii. If your vehicle is equipped with an automatic transmission, several miles and/or days of driving may be required for all adaptive learning to complete. Do not be alarmed at shift quality immediately after installing of tune. It is recommended to do light throttle driving until shift quality has stabilized.

D. When sending in your tune request via email, please include the required information below:

1. First Name
2. Last Name
3. Street Address
4. City
5. ZIP / Postal Code
6. Phone Number
7. Email Address
8. Serial Number From Device
9. Vehicle Year
10. Vehicle Make
11. Vehicle Model
12. Engine
13. Octane of Fuel**
14. ECU / Strategy Code
15. SW ID Number

******(Vortech tune **requires** use of 91 octane fuel. Use of another fuel will void emissions compliance.)

Email all tune requests to:

tuning@livernoismotorsports.com

Livernois Motorsports business hours - 9:00am - 6:00pm EST

Please allow 24-48 business hours to create the tune.

10. FINAL CHECK

WARNING: Do not attempt to operate the vehicle until all components are installed and all operations are completed including the final check.

- A. If your vehicle has gone over 15,000 miles since its last spark plug change, you will need to change the spark plugs now *before* test driving the vehicle.
- B. Check all fittings, nuts, bolts and clamps for tightness. Pay particular attention to oil and fuel lines around moving parts, sharp edges and exhaust system parts. Make sure all wires and lines are properly secured with clamps or tie-wraps.
- C. Check all fluid levels, making sure that your tank(s) is/are filled with 91 octane or higher fuel before commencing test drive.
- D. Start the engine and allow to idle a few minutes, then shut off.
- E. Recheck to be sure that no hoses, wires, etc. are near exhaust headers or moving parts. Look also for any signs of fluid leakage.
- F. **PLEASE TAKE SPECIAL NOTE:** Operating the vehicle without ALL the subassemblies completely and properly installed may cause **FAILURE OF MAJOR COMPONENTS.**
- G. Test drive the vehicle.
- H. Always listen carefully for engine detonation. Discontinue heavy throttle usage if detonation is heard.
- I. Read the **STREET SUPERCHARGER SYSTEM OWNER'S MANUAL AND RETURN THE WARRANTY REGISTRATION FORM** within thirty (30) days of purchasing your supercharger system to qualify.

For internally lubricated V3 units only

This supercharger has been factory pre-filled with special Vortech synthetic lubricant. Oil does not need to be added to a brand new unit; however a fluid level check should be performed.

Prior to operating the supercharger on the vehicle and after installation onto the vehicle:

Remove the factory installed flat-head brass shipping plug (not the dipstick) from the top of the supercharger case. Replace the sealed shipping plug with the supplied "vented" plug. Do not operate the supercharger without it. Check the supercharger fluid level.

Fluid level checking procedure:

1. Ensure that the .06" copper sealing washer is located on the dipstick base.
2. Thread the clean dipstick into the unit until it seats.
3. Once the dipstick has seated, remove the dipstick from the unit. Fluid should register in the crosshatched area on the dipstick.
4. **DO NOT OVERFILL!!!** Drain excess fluid from the unit if it is above the maximum level on the dipstick.

Check the fluid level using the dipstick at least every 2,500 miles.

Initial supercharger fluid change must be performed at 2,500 miles. The supercharger fluid must be changed at least every 7,500 miles.

Drain the fluid, refill the unit with 4 oz. of Vortech V3 synthetic lubricating fluid and then confirm proper oil level using the dipstick. **DO NOT OVERFILL!!!**

WARNING: Use of any other fluid other than the special Vortech /Paxton synthetic lubricant will void the warranty and may cause component failure.

This page was left intentionally blank.

APPENDIX A. DIAGRAM, ASSEMBLY, SUPERCHARGER MOUNTING BRACKET

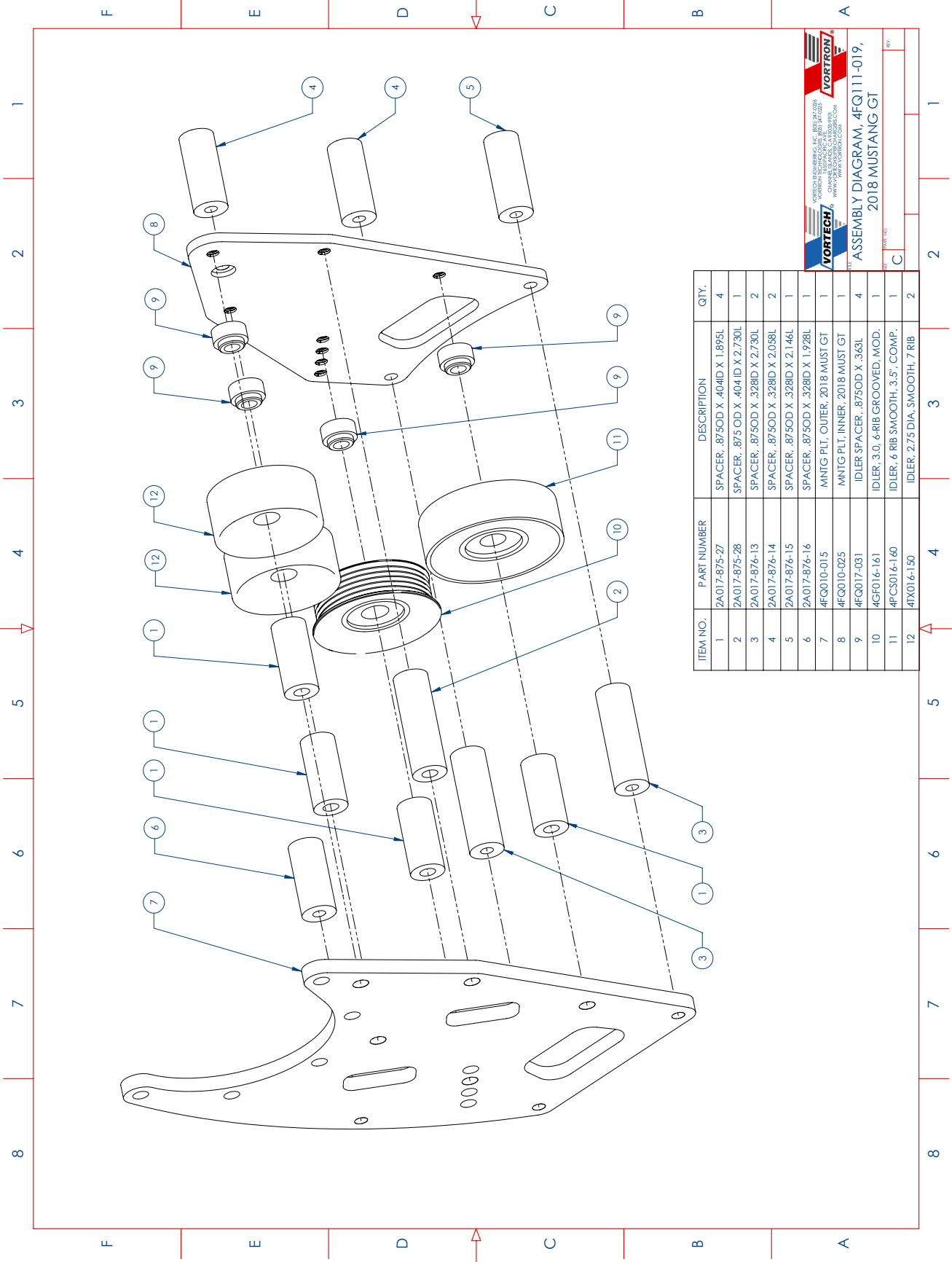

ITEM NO.	PART NUMBER	DESCRIPTION	QTY.
1	2A017-875-27	SPACER, .8750D X .404ID X 1.895L	4
2	2A017-875-28	SPACER, .875 OD X .404 ID X 2.730L	1
3	2A017-876-13	SPACER, .8750D X .328ID X 2.730L	2
4	2A017-876-14	SPACER, .8750D X .328ID X 2.098L	2
5	2A017-876-15	SPACER, .8750D X .328ID X 2.146L	1
6	2A017-876-16	SPACER, .8750D X .328ID X 1.928L	1
7	4FQ010-015	MNTG PLT, OUTER, 2018 MUST GT	1
8	4FQ010-025	MNTG PLT, INNER, 2018 MUST GT	1
9	4FQ017-031	IDLER SPACER, .8750D X .363L	4
10	4GF016-161	IDLER, 3.0, 6-RIB GROOVED, MOD.	1
11	4FCS016-160	IDLER, 6 RIB SMOOTH, 3.5", COMP.	1
12	4FX016-150	IDLER, 2.75 DIA, SMOOTH, 7 RIB	2

VORTECH
 VORTECH ENGINEERING, INC. 8651 347 0224
 VORTRON TECHNOLOGIES, INC. 8601 347 0222
 10000 W. 14TH AVENUE, SUITE 1000
 DENVER, CO 80202-1000
 WWW.VORTECH.COM



VORTRON
 VORTRON TECHNOLOGIES, INC. 8601 347 0222
 10000 W. 14TH AVENUE, SUITE 1000
 DENVER, CO 80202-1000
 WWW.VORTRON.COM

110 ASSEMBLY DIAGRAM, 4FQ111-019,
 2018 MUSTANG GT
 REV: 167

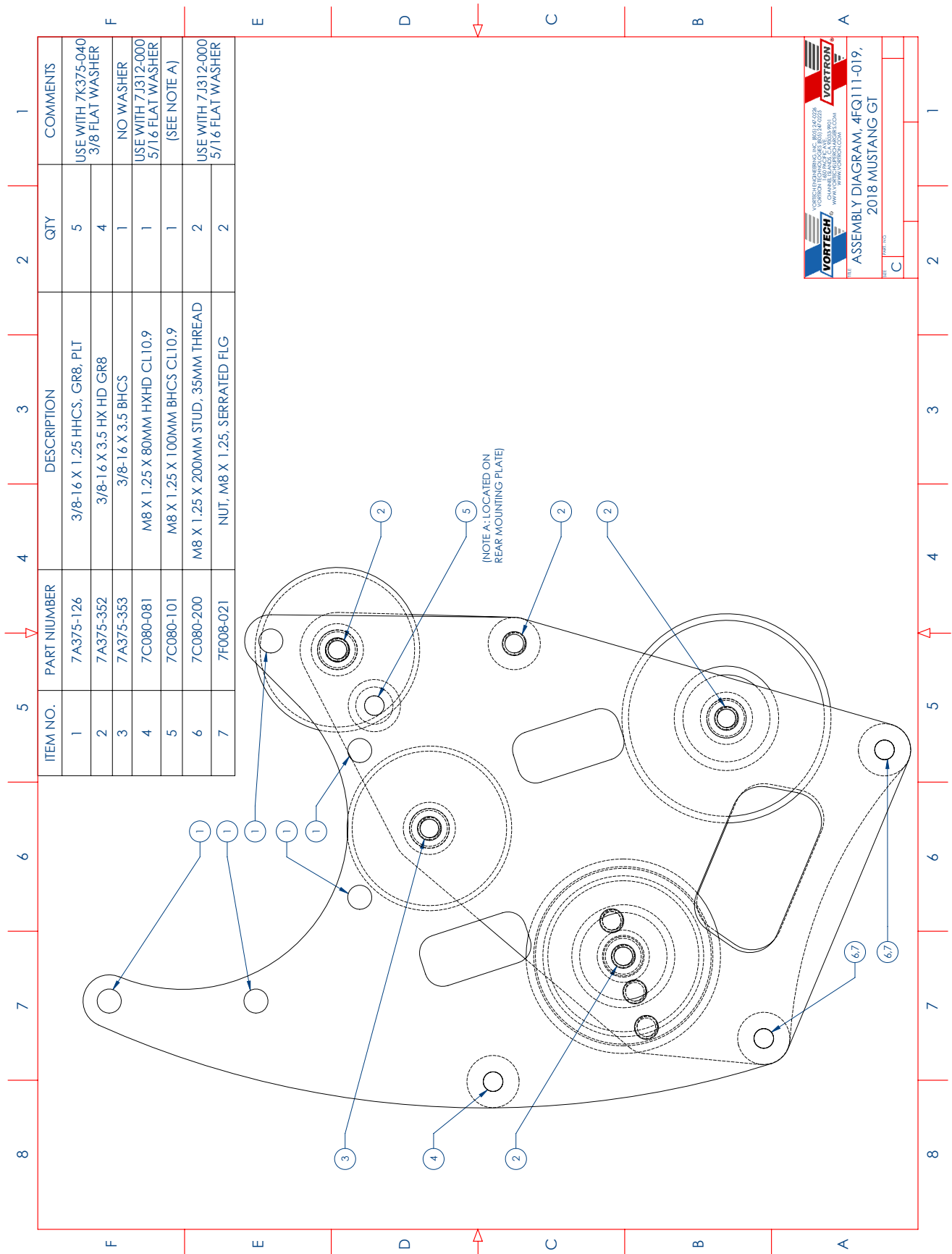
APPENDIX B. DIAGRAM, HARDWARE, SUPERCHARGER MOUNTING BRACKET

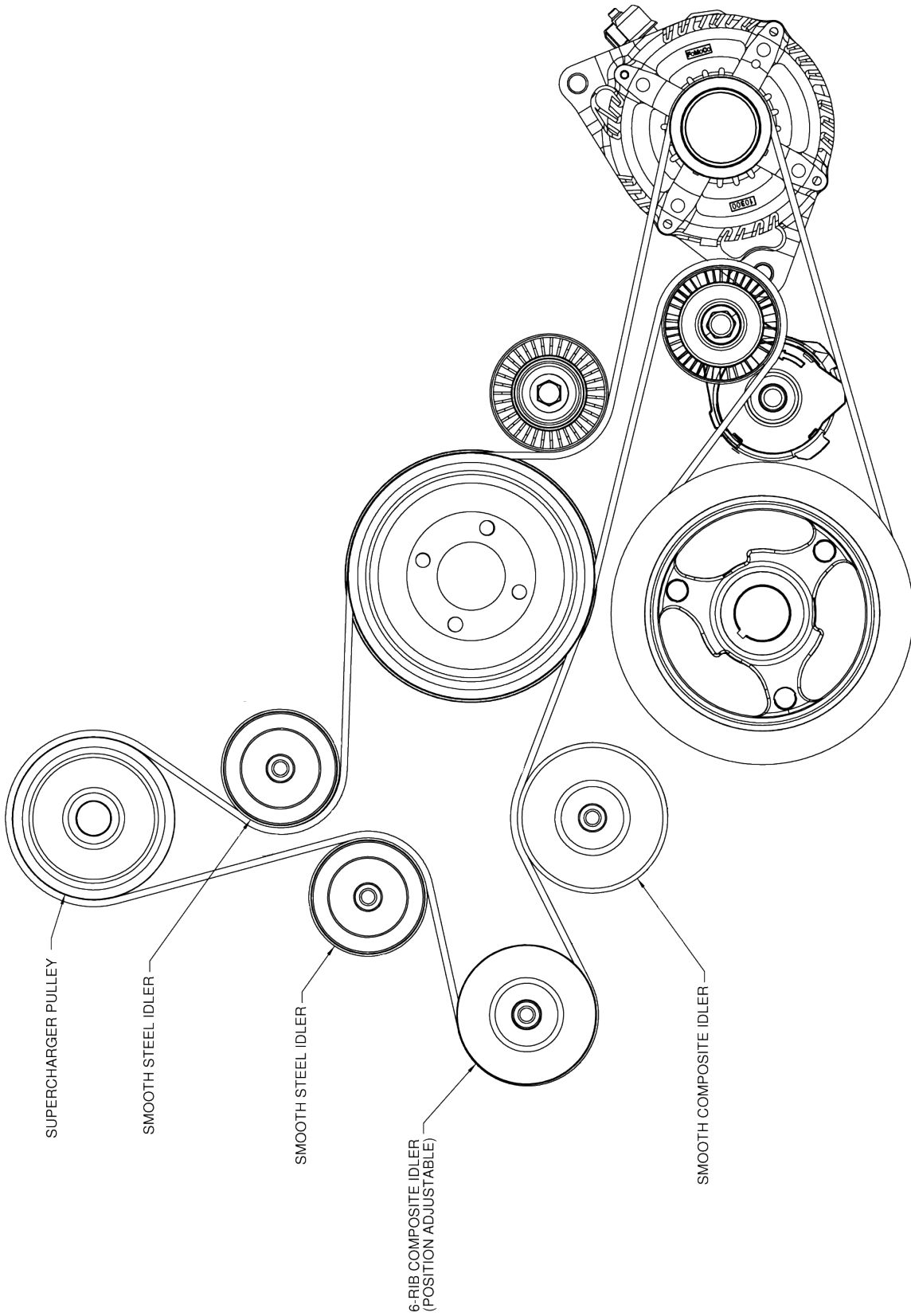

APPENDIX C. DIAGRAM, BELT ROUTING





ENGINEERING, INC

1650 Pacific Avenue, Channel Islands, CA 93033-9901 • Phone (805) 247-0226
Fax: (805) 247-0669 • www.vortechsuperchargers.com • M-F 7:00 AM - 3:30 PM (PST)