

Ford 5.0L Mustang GT Supercharger System Installation Instructions

2015-2017 Model Year
50 State Smog Legal Per CARB EO# D-213-36

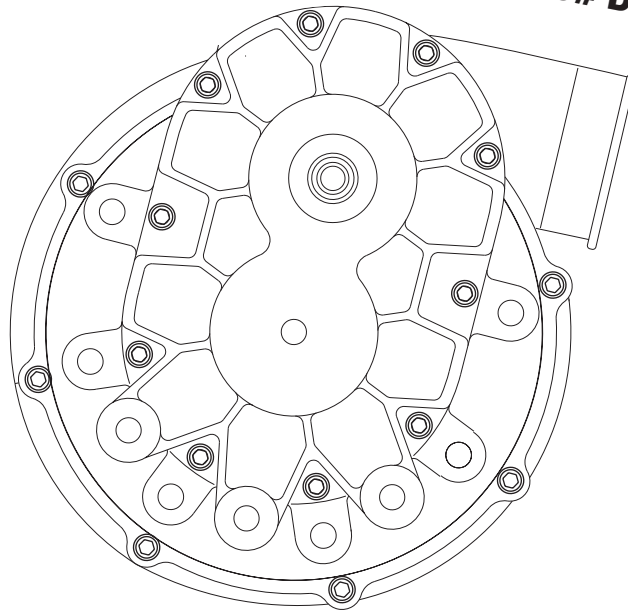

ENGINEERING, INC

1650 Pacific Avenue, Channel Islands, CA 93033-9901 • Phone (805) 247-0226
Fax: (805) 247-0669 • www.vortechsuperchargers.com • M-F 7:00 AM - 3:30 PM (PST)

FOREWORD

This manual provides information on the installation, maintenance and service of the Vortech supercharger kit expressly designed for this vehicle. All information, illustrations and specifications contained herein are based on the latest product information available at the time of this publication. Changes to the manual may be made at any time without notice. Contact Vortech Engineering for any additional information regarding this kit and any of these modifications at (805) 247-0226 7:00am-3:30pm PST.



Take note of the following before proceeding:

1. Proper installation of this supercharger kit requires general automotive mechanic knowledge and experience. Please browse through each step of this instruction manual prior to beginning the installation to determine if you should refer the job to a professional installer/technician. Please contact your dealer or Vortech Engineering for possible installers in your area.
2. This product was designed for use on stock (un-modified, OEM) vehicles. The PCM (computer), engine, transmission, drive axle ratios and tire O.D. must be stock. If the vehicle or engine has been modified in any way, check with Vortech prior to installation and use of this product.
3. Use only premium grade fuel with a minimum of 91 octane (*R+M/2*).
4. Always listen for any sign of detonation (*knocking/pinging*) and discontinue hard use (*no boost*) until problem is resolved.
5. Vortech is not responsible for any clutch, transmission, drive-line or engine damage.

Exclusions from Vortech warranty coverage considerations include, but not limited to:

1. Neglect, abuse, lack of maintenance, abnormal operation or improper installation.
2. Continued operation with an impaired vehicle or sub-system.
3. The combined use of Vortech components with other modifications such as, but not limited to, exhaust headers, aftermarket camshafts, nitrous oxide, third party PCM programming or other such changes.

©2020 VORTECH ENGINEERING, INC

All rights reserved. No part of this publication may be reproduced, transmitted, transcribed, or translated into another language in any form, by any means without written permission of Vortech Engineering, Inc.

TABLE OF CONTENTS

FOREWORD	ii
TABLE OF CONTENTS	iii
IMPORTANT NOTES	iv
TOOL & SUPPLY REQUIREMENTS	v
PARTS LIST	vi
1. BASIC COMPONENT REMOVAL	1
2. MISCELLANEOUS PREPARATION	9
3. SUPERCHARGER ASSEMBLY PREPARATION & INSTALLATION	11
3.1 MOUNTING BRACKET ASSEMBLY DIAGRAM	19
3.2 BELT ROUTING DIAGRAM	20
4. PCV SYSTEM MODIFICATION	21
5. CHARGE AIR COOLER (CAC) & DISCHARGE TUBE INSTALLATION	23
6. FUEL INJECTOR REPLACEMENT	29
7. ENGINE COOLING SYSTEM MODIFICATION	31
8. AIR INLET ASSEMBLY INSTALLATION	37
8.1 VACUUM ROUTING DIAGRAM - 2015-2016 & EARLY-MODEL 2017 VEHICLES	42
8.2 VACUUM ROUTING DIAGRAM - LATE-MODEL 2017 VEHICLES	46
9. BYPASS VALVE CONNECTION	47
10. MISCELLANEOUS REASSEMBLY	49
11. OIL FEED INSTALLATION (OIL-FED UNITS ONLY)	51
12. OIL DRAIN INSTALLATION (OIL-FED UNITS ONLY)	53
13. REFLASH COMPUTER	55
14. FINAL CHECK	57

NOTICE

This product is protected by state common law, copyright and/or patent. All legal rights therein are reserved. The design, layout, dimensions, geometry, and engineering features shown in this product are the exclusive property of Vortech Engineering, Inc. This product may not be copied or duplicated in whole or part, abstractly or fundamentally, intentionally or fortuitously, nor shall any design, dimension, or other information be incorporated into any product or apparatus without prior written consent of Vortech Engineering, Inc.

'15-'17 FORD MUSTANG GT

Installation Instructions

Congratulations on selecting the best performing and best backed automotive supercharger available today... the VORTECH® supercharger!

Before beginning this installation, please read through this entire instruction booklet and the Street Supercharger System Owner's Manual which includes the Limited Warranty Program, the Warranty Registration form and return envelope.

Vortech supercharger systems are performance improving devices. In most cases, increases in torque of 30-35% and horsepower between 35-45% can be expected with the boost levels specified by Vortech Engineering. This product is intended for use on healthy, well maintained engines. Installation on a worn-out or damaged engine is not recommended and may result in failure of the engine as well as the supercharger. Vortech Engineering is not responsible for engine damage.

Installation on new vehicles will not harm or adversely affect the break-in period so long as factory break-in procedures are followed.

For best performance and continued durability, please take note of the following key points:

1. Use only premium grade fuel 91 octane or higher (R+M/2).
2. The engine must have stock compression ratio.
3. If the engine has been modified in any way, check with Vortech prior to using this product.
4. Always listen for any sign of detonation (pinging) and discontinue hard use (no boost) until problem is resolved.
5. Perform an oil and filter change upon completion of this installation and prior to test driving your vehicle. Thereafter, always use a high grade SF rated engine oil or a high quality synthetic, and change the oil and filter at least every 3,000 miles. Never attempt to extend the oil change interval beyond 3,000 miles, regardless of oil manufacturer's claims as potential damage to the supercharger may result.
6. Before beginning installation, replace all spark plugs that are older than 1 year or 15,000 miles with original heat range plugs as specified by the manufacturer and reset timing to factory specifications (follow the procedures indicated within the factory repair manual and/or as indicated on the factory underhood emissions tag). Do not use platinum spark plugs unless they are original equipment. Change spark plugs every 20,000 miles.

TOOL & SUPPLY REQUIREMENTS

- Factory repair manual
- 3/8" socket and drive set: SAE & metric
- 1/2" socket and drive set: SAE & metric
- Adjustable wrench
- Open end wrenches: metric
- TORX T-20 driver
- Utility knife
- **Oil-Fed Kits:** 3/8" NPT tap, center punch, 5/8" tapered punch, heavy grease, 8 quarts manufacturer-specified engine oil, oil filter, oil filter wrench

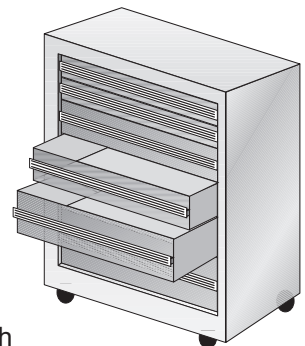

If it has been 35,000 miles or more since your vehicle's last spark plug change, then you will also need:

- Spark plug socket
- NEW spark plugs



2015-2017 Ford Mustang GT, H.O.

Part No. 4FQ218-064L

PARTS LIST

IMPORTANT: Before beginning installation, verify that all parts are included in the kit. Report any shortages or damaged parts immediately.

PART NO.	DESCRIPTION	QTY.	PART NUMBER	DESCRIPTION	QTY.
008110	DECAL, VINYL, VORTECH	2	4FQ114-030	ENG COOL SYS MOD ASY, '15 MUST	1
008130	LICENSE PLATE FRAME, VORTECH1		5W001-085	SLEEVE, FLEX BRAID 1.5" NOM.	1
008447	1 YR S/C WARRANTY PKG	1	7P312-050	5/16 UNION HOSE MENDER	1
009035	S/C LUBE, BOTTLED, 3-PACK	1	7P375-050	3/8 HOSE UNION, BRASS	1
2F329-214	S/C ASSEMBLY, 2015 MUSTANG GT1		7P375-075	3/4" HOSE BARB UNION, BRASS	1
4FQ020-015	INSTR.MAN., '15 FORD MUSTANG GT	1	7P375-098	TEE, 3/8 INCH, PLASTIC	1
4FQ111-013	MNTG BRKT ASY, G2, 2015 MUST 1		7R002-024	#24 SAE TYPE F SS HOSE CLAMP	2
2A017-875-27	SPACER, .875OD X .404ID X 1.895L	4	7R004-001	STEPLESS CLAMP, 15.7-70	4
2A017-875-28	SPACER, .875 OD X 2.730 LONG	1	7R004-002	STEPLESS CLAMP, 17.0-70	7
2A017-876-13	SPACER, .875OD X .328ID X 2.730L	2	7R004-007	STEPLESS CLAMP, 28.6 X 7MM	2
2A017-876-14	SPACER, .875OD X .328ID X 2.058L	2	7U030-056	3/8 PCV/VAC RUBBER HOSE	2.5
2A017-876-15	SPACER, .875OD X .328ID X 2.146L	1	7U030-065	HOSE, 3/4 X 90° RUBBER, SHORT	1
2A017-876-16	SPACER, .875OD X .328ID X 1.928L	1	7U030-109	VAC HOSE, 7/64 ID	.50FT
2A046-031	BELT, 6 RIB X 103.31 EFF. LENGTH	1	7U031-016	5/16 PCV/VAC RUBBER HOSE	1
4FQ010-011	MNTG PLT, OUTER, 2011 MSTG 5.0	1	7U038-000	3/4 HEATER HOSE	3
4FQ010-021	MNTG PLT, INNER, 2011 MSTG 5.0	1	8N155-090	WATER TANK WELD ASY, 2015 MUST	1
4FQ017-021	SPCR, .875/1.25OD X .328ID X 1.782L	4	4FQ112-094	DISCH ASY, 2015 MUST 5.0 BLK 1	1
4FQ017-031	SPCR, .875ODX.404IDX.363L W/66 PLT	1	4FQ012-090	DISCH. TUBE C, 2015 MUST GT	1
4GF016-161	PULLEY, 3" IDLER, GROOVED, MOD	1	4FQ012-134	DISCH. DUCT A, V-7, 2015 MUST GT	1
4PCS016-160	PULLEY, IDLER, SRT10 TRUCK	1	4FQ017-051	SPACER, TB, 1.25, 2011 MUST GT	1
4TX016-150	IDLER, 2.75 DIA, SMOOTH, 7 RIB	2	4FQ112-080	ASY, DISCH. TUBE B, 2015 MUST GT	1
7A375-126	3/8-16 X 1.25 HHCS, GR8, PLT	5	4FQ112-104	ASY, DISCH. TUBE D, 2015 MUST GT	1
7A375-352	3/8-16 X 3.5" HX HD GR8	5	7C040-008	M4-.7 X 8MM SCHD SS	2
7C080-064	M8 X 1.25 X 65MM BHCS CL10.9	1	7C060-080	M6 X 1.00 X 80 SHCS CL 12.9	4
7C080-081	M8 X 1.25 X 80 HXHD CL10.9	1	7F008-021	NUT, M8 X 1.25, SERRATED FLG	4
7C080-101	M8-1.25 X 100 BHCS CL10.9	1	7J006-093	6MM WASHER, PLATED	4
7C080-200	M8-1.25 X 200MM STUD, 35MM THREAD	2	7J312-875	5/16" WASHER, 7/8" OD, CUSTOM	4
7F008-021	NUT, M8 X 1.25, SERRATED FLG	2	7P062-187	1/16 NPT X 3/16 HOSE BARB	1
7J312-000	5/16 FLAT WASHER-SAE	3	7P157-219	REDUCER UNION, 5/32" TO 7/32"	1
7K375-040	3/8 AN960 FLAT WASHR PLATED	9	7P500-016	TEE, .5X.5X1/16NPT, METAL	1
7K375-050	3/8 WASHER, STAINLS, .030THK	1	7PS300-277	SLEEVE, BUMP REDUCER, 3.0- 2.75	1
4FQ112-110	AIR INLET ASSY, '15 MUSTANG GT1		7PS300-300	SLEEVE, BLACK, 3.00D X 3.00	2
008358	DECAL, INLET, 2011 MSTG GT VORT	1	7PS300-301	BUMP HOSE, 3.00D X 3.00L	1
4FQ012-110	AIR INLET DUCT, 2015 MUSTANG	1	7PS350-301	REDUCER, BLK 3.5-3.0 X 3.0L	1
5W001-039	1" HEAT SHRINK TUBING	3	7PS350-304	SLEEVE, BLACK 3.50" D X 3.0" L	1
5W001-082	SLEEVE, FLEX BRAID 0.75" NOM.	.75	7PS400-350	REDUCER, BLK 4.0-3.5 X 3.0L	1
7C040-008	M4-.7X8MM SCHD SS	2	7PS400-354	ELBOW, 4.0 X 3.5 S-SHAPE, SILICONE	1
7J006-093	6MM WASHER, PLATED	2	7R002-044	#44 SAE TYPE F SS HOSE CLAMP	1
7P250-045	1/4 MALE NPT X 3/8 MALE BARB	1	7R002-048	#48 SAE TYPE F SS HOSE CLAMP	7
7P375-039	3/8 NPT X 5/8 BARB 90°	1	7R002-056	#56 SAE TYPE F SS HOSE CLAMP	5
7P375-098	TEE, 3/8" INCH, PLASTIC	1	7R002-064	#64 SAE TYPE F SS HOSE CLAMP	2
7P375-106	PCV VALVE, FORD 3/8" HOSE	1	7U012-238	O-RING, 2-238, 3.484ID X .139	1
7P375-378	VALVE, CHECK, 3/8 BARB X 3/8 BARB	1	7U030-046	5/32" VACUUM LINE	.25
7P500-039	1/2 NPT X 5/8 BARB 90, PLATED	1	7U030-218	7/32 VAC HOSE, BUNA-N	5FT
7P625-091	5/8 X 5/8 90° BARB ELBOW, PL	1	8A003-074	MAF, 3.8 ID, BLACK	1
7P625-375	REDUCER, 5/8 BARB TO 3/8 BARB	1	8H040-175	FILTER, 1.75" I.D., RACE BYPASS	1
7PS375-100	SLEEVE, 3.75 X 1.0 3-PLY MATTE BLK	1	8D204-064	RACE BYPASS VALVE, G3 BLK/SAT1	
7PS400-200	SLEEVE, BLACK 4.0D X 2.0	1	8PN101-054	WELDED CORE ASY,05 MUST, BLK1	
7PS400-225	BUMP SLEEVE, 4.0 X 2.25, BLACK	1	8F160-046	FUEL INJECTOR ASSY, 2011 MSTG1	
7PS400-351	REDUCER SLEEVE, 4.0 X 3.5 X 2.35L	1	4FQ017-041	SPCR, FUEL RAIL, EV14, 2011 MSTG GT	4
7R002-052	352 SAE TYPE F SS HOSE CLAMP	1	8F060-046	FUEL INJ, 47LB EV14	8
7R002-064	#64 SAE TYPE F SS HOSE CLAMP	4	7C060-091	M6 X 1.0 X 90MM SHCS PLT GR12.9	4
7R004-002	STEPLESS CLAMP, 17.0-70	4	7J250-001	1/4 WASHER, SAE, PLATED	4
7R004-004	STEPLESS CLAMP, 25.6 X 7MM WIDE	7	8H040-205	AIR FILTER, 2015 MSTG GT PANEL1	
7R004-007	STEPLESS CLAMP, 28.6 X 7MM WIDE	1	5A003-070	SCT TUNER, 11-15 MUSTANG GT 1	
7U030-056	3/8 PCV/VAC RUBBER HOSE	3FT			
7U033-000	5/8 PCV HOSE	1.75FT			
7U100-055	TIE WRAP, 7.5" NYLON	10			
7U375-056	1" VACUUM CAP FOR 1" NIPPLE	1			
8A004-007-1	BLK OFF PLT, VORT, FORD SLOT MAF	1			



2015-2017 Ford Mustang GT, H.O. Tuner Kit

Part No. 4FQ218-164L

PARTS LIST

IMPORTANT: Before beginning installation, verify that all parts are included in the kit. Report any shortages or damaged parts immediately.

PART NO.	DESCRIPTION	QTY.	PART NUMBER	DESCRIPTION	QTY.
008110	DECAL, VINYL, VORTECH	2	4FQ114-030	ENG COOL SYS MOD ASY, '15 MUST	1
008130	LICENSE PLATE FRAME, VORTECH	1	5W001-085	SLEEVE, FLEX BRAID 1.5" NOM.	1
008447	1 YR S/C WARRANTY PKG	1	7P312-050	5/16 UNION HOSE MENDER	1
009035	S/C LUBE, BOTTLED, 3-PACK	1	7P375-050	3/8 HOSE UNION, BRASS	1
2F329-214	S/C ASSEMBLY, 2015 MUSTANG GT1		7P375-075	3/4" HOSE BARB UNION, BRASS	1
4FQ020-015	INSTR.MAN.,'15 FORD MUSTANG GT	1	7P375-098	TEE, 3/8 INCH, PLASTIC	1
4FQ111-013	MNTG BRKT ASY, G2, 2015 MUST	1	7R002-024	#24 SAE TYPE F SS HOSE CLAMP	2
2A017-875-27	SPACER, .875OD X .404ID X 1.895L	4	7R004-001	STEPLESS CLAMP, 15.7-70	4
2A017-875-28	SPACER, .875 OD X 2.730 LONG	1	7R004-002	STEPLESS CLAMP, 17.0-70	7
2A017-876-13	SPACER, .875OD X .328ID X 2.730L	2	7R004-007	STEPLESS CLAMP, 28.6 X 7MM	2
2A017-876-14	SPACER, .875OD X .328ID X 2.058L	2	7U030-056	3/8 PCV/VAC RUBBER HOSE	2.5
2A017-876-15	SPACER, .875OD X .328ID X 2.146L	1	7U030-065	HOSE, 3/4 X 90° RUBBER, SHORT	1
2A017-876-16	SPACER, .875OD X .328ID X 1.928L	1	7U030-109	VAC HOSE, 7/64 ID	.50FT
2A046-031	BELT, 6 RIB X 103.31 EFF. LENGTH	1	7U031-016	5/16 PCV/VAC RUBBER HOSE	1
4FQ010-011	MNTG PLT, OUTER, 2011 MSTG 5.0	1	7U038-000	3/4 HEATER HOSE	3
4FQ010-021	MNTG PLT, INNER, 2011 MSTG 5.0	1	8N155-090	WATER TANK WELD ASY, 2015 MUST	1
4FQ017-021	SPCR, .875/1.25OD X .328ID X 1.782L	1	4FQ112-094	DISCH ASY, 2015 MUST 5.0 BLK	1
4FQ017-031	SPCR, .875ODX.404IDX.363L W/.66 PLT	4	4FQ012-090	DISCH. TUBE C, 2015 MUST GT	1
4GF016-161	PULLEY, 3" IDLER, GROOVED, MOD	1	4FQ012-134	DISCH. DUCT A, V-7, 2015 MUST GT	1
4PCS016-160	PULLEY, IDLER, SRT10 TRUCK	1	4FQ017-051	SPACER, TB, 1.25, 2011 MUST GT	1
4TX016-150	IDLER, 2.75 DIA, SMOOTH, 7 RIB	2	4FQ112-080	ASY, DISCH. TUBE B, 2015 MUST GT	1
7A375-126	3/8-16 X 1.25 HHCS, GR8, PLT	5	4FQ112-104	ASY, DISCH. TUBE D, 2015 MUST GT	1
7A375-352	3/8-16 X 3.5" HX HD GR8	5	7C040-008	M4-.7 X 8MM SCHD SS	2
7C080-064	M8 X 1.25 X 65MM BHCS CL10.9	1	7C060-080	M6 X 1.00 X 80 SHCS CL 12.9	4
7C080-081	M8 X 1.25 X 80 HXHD CL10.9	1	7F008-021	NUT, M8 X 1.25, SERRATED FLG	4
7C080-101	M8-1.25 X 100 BHCS CL10.9	1	7J006-093	6MM WASHER, PLATED	4
7C080-200	M8-1.25 X 200MM STUD, 35MM THREAD	2	7J312-875	5/16" WASHER, 7/8" OD, CUSTOM	4
7F008-021	NUT, M8 X 1.25, SERRATED FLG	2	7P062-187	1/16 NPT X 3/16 HOSE BARB	1
7J312-000	5/16 FLAT WASHER-SAE	3	7P157-219	REDUCER UNION, 5/32" TO 7/32"	1
7K375-040	3/8 AN960 FLAT WASHR PLATED	9	7P500-016	TEE, .5X.5X1/16NPT, METAL	1
7K375-050	3/8 WASHER, STAINLS, .030THK	1	7PS300-277	SLEEVE, BUMP REDUCER, 3.0- 2.75	1
4FQ112-110	AIR INLET ASSY, '15 MUSTANG GT1		7PS300-300	SLEEVE, BLACK, 3.00D X 3.00	2
008358	DECAL, INLET, 2011 MSTG GT VORT	1	7PS300-301	BUMP HOSE, 3.00D X 3.00L	1
4FQ012-110	AIR INLET DUCT, 2015 MUSTANG	1	7PS350-301	REDUCER, BLK 3.5-3.0 X 3.0L	1
5W001-039	1" HEAT SHRINK TUBING	3	7PS350-304	SLEEVE, BLACK 3.50" D X 3.0" L	1
5W001-082	SLEEVE, FLEX BRAID 0.75" NOM.	.75	7PS400-350	REDUCER, BLK 4.0-3.5 X 3.0L	1
7C040-008	M4-.7X8MM SCHD SS	2	7PS400-354	ELBOW, 4.0 X 3.5 S-SHAPE, SILICONE	1
7J006-093	6MM WASHER, PLATED	2	7R002-044	#44 SAE TYPE F SS HOSE CLAMP	1
7P250-045	1/4 MALE NPT X 3/8 MALE BARB	1	7R002-048	#48 SAE TYPE F SS HOSE CLAMP	7
7P375-039	3/8 NPT X 5/8 BARB 90°	1	7R002-056	#56 SAE TYPE F SS HOSE CLAMP	5
7P375-098	TEE, 3/8" INCH, PLASTIC	1	7R002-064	#64 SAE TYPE F SS HOSE CLAMP	2
7P375-106	PCV VALVE, FORD 3/8" HOSE	1	7U012-238	O-RING, 2-238, 3.484ID X .139	1
7P375-378	VALVE, CHECK, 3/8 BARB X 3/8 BARB	1	7U030-046	5/32" VACUUM LINE	.25
7P500-039	1/2 NPT X 5/8 BARB 90, PLATED	1	7U030-218	7/32 VAC HOSE, BUNA-N	5FT
7P625-091	5/8 X 5/8 90° BARB ELBOW, PL	1	8A003-074	MAF, 3.8 ID, BLACK	1
7P625-375	REDUCER, 5/8 BARB TO 3/8 BARB	1	8H040-175	FILTER, 1.75" I.D., RACE BYPASS	1
7PS375-100	SLEEVE, 3.75 X 1.0 3-PLY MATTE BLK	1	8D204-064	RACE BYPASS VALVE, G3 BLK/SAT1	
7PS400-200	SLEEVE, BLACK 4.0D X 2.0	1	8PN101-054	WELDED CORE ASY,05 MUST, BLK1	
7PS400-225	BUMP SLEEVE, 4.0 X 2.25, BLACK	1	8H040-205	AIR FILTER, 2015 MSTG GT PANEL1	
7PS400-351	REDUCER SLEEVE, 4.0 X 3.5 X 2.35L	1			
7R002-052	352 SAE TYPE F SS HOSE CLAMP	1			
7R002-064	#64 SAE TYPE F SS HOSE CLAMP	4			
7R004-002	STEPLESS CLAMP, 17.0-70	4			
7R004-004	STEPLESS CLAMP, 25.6 X 7MM WIDE	7			
7R004-007	STEPLESS CLAMP, 28.6 X 7MM WIDE	1			
7U030-056	3/8 PCV/VAC RUBBER HOSE	3FT			
7U033-000	5/8 PCV HOSE	1.75FT			
7U100-055	TIE WRAP, 7.5" NYLON	10			
7U375-056	1" VACUUM CAP FOR 1" NIPPLE	1			
8A004-007-1	BLK OFF PLT, VORT, FORD SLOT MAF	1			

This page was left intentionally blank.

1. BASIC COMPONENT REMOVAL

- A. Remove 8x plastic fasteners securing the black plastic cover above the grille and radiator. Pop the center section of each fastener upward and then the larger part of the fastener will loosen. Remove the cover and set aside for later re-installation.
(See Fig. 1-a)



Fig. 1-a: Remove Plastic Cover

- B. Remove the 6x 8mm-headed fasteners securing the front bumper cover to the upper radiator support. Set aside for later re-installation.
(See Fig. 1-b)



Fig. 1-b: Remove Bumper Cover Fasteners

- C. There are 2x 5.5mm-headed fasteners (1x per side) hidden underneath the weather stripping on the top of the bumper cover near the headlights. Remove these fasteners & set aside for later re-installation.
(See Fig. 1-c)



Fig. 1-c: Remove 5.5mm-Headed Fastener

1. BASIC COMPONENT REMOVAL, cont'd

- D. Remove the 4x plastic fasteners securing the fender liners to the fenders & front undertray. Do this for both sides.

(See Fig. 1-d)



Fig. 1-d: Remove Fender Liner Fasteners

- E. Remove the 19x 7mm-headed fasteners & 2x plastic fasteners securing the front undertray to the bumper cover & K-member.

(See Fig. 1-e)



Fig. 1-e: Remove Front Undertray

- F. There are 2x 7mm-headed fasteners (1x per side) securing the corners of the front bumper cover to the fender. You will need to pull back the fender liner to access this fasteners & remove.

(See Fig. 1-f)



Fig. 1-f: Bumper Corner Fastener
(Bumper Removed)

1. BASIC COMPONENT REMOVAL, cont'd

- G. With the front undertray removed, reach up behind the front bumper cover & unplug the fog light connectors. Do this for both sides.

(See Fig. 1-g)



Fig. 1-g: Unplug Fog Light Connectors

- H. Pull the corners of the front bumper cover away from the fender. Carefully remove the front bumper cover from the vehicle, exposing the bumper support.

(See Fig. 1-h)



Fig. 1-h: Remove Front Bumper Cover

- I. You will notice a wire harness running along the back side of the bumper support secured by 3x gray clips. Free the harness from the bumper support.

(See Fig. 1-i)



Fig. 1-i: Detach Wire Harness

1. BASIC COMPONENT REMOVAL, cont'd

- J. Release the gray clips from the wire harness & set aside. These will not be reused.

(See Fig. 1-j)



Fig. 1-j: Remove Gray Wire Harness Clips

- K. Unplug the clip from the ambient air temp sensor, then release the harness from the bumper support. Also, remove the sensor & set aside for later re-installation.

(See Fig. 1-k)

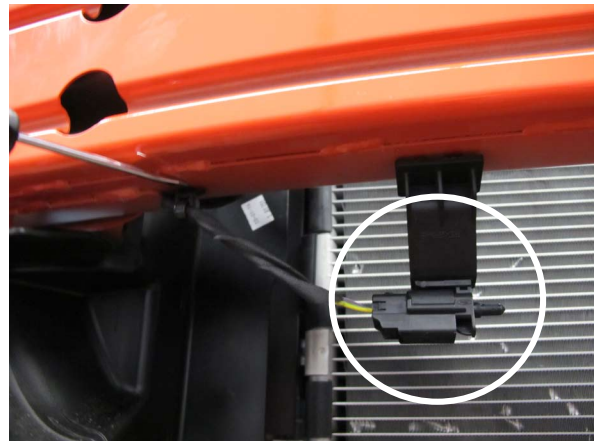

Fig. 1-k: Remove Ambient Air Temp Sensor

- L. Remove the both radiator shrouds. These will be trimmed in a later step.

(See Fig. 1-l)

NOTE: If your vehicle is equipped with the optional front braces, they will need to be removed at this time. Remove the 4x 13mm-headed fasteners securing the braces to the upper radiator support & front bumper support.



Fig. 1-l: Remove Radiator Shrouds

1. BASIC COMPONENT REMOVAL, cont'd

- M. Remove the engine cover, disconnect the hoses going to the intake tube & proceed to remove the intake tube from the vehicle. It will not be reused.
(See Fig. 1-m)



Fig. 1-m: Remove Intake Tube

- N. Remove the interior sound tube by pulling it towards the front of the vehicle.
(See Fig. 1-n)



Fig. 1-n: Remove Interior Sound Tube

- O. Remove the pressure cap from the engine coolant reservoir near the passenger side front of the engine compartment. Locate the engine coolant drain valve at the bottom passenger side corner of the radiator. Open the valve and drain the coolant into a clean container for later reuse. Drain enough to empty the reservoir and below the level of the upper radiator hose.
(See Fig. 1-o)

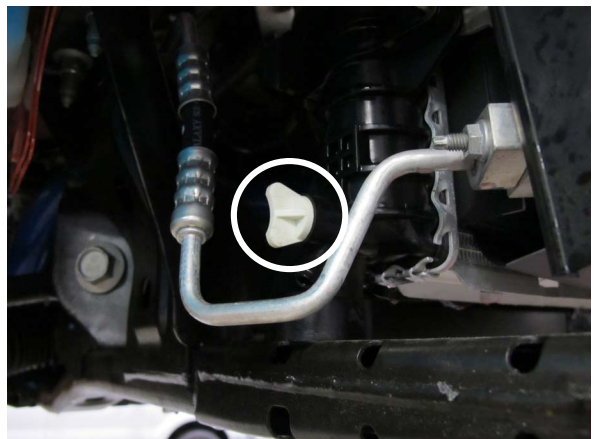

Fig. 1-o: Drain Engine Coolant

1. BASIC COMPONENT REMOVAL, cont'd

- P. Unclamp and disconnect the 2x small hoses from the upper portion of the coolant reservoir & disconnect the larger hose from the bottom of the coolant reservoir. Be prepared to catch any spillage. Remove the 2x 10mm-headed fasteners securing the coolant reservoir. Remove the reservoir and set it aside. It will not be reused.

(See Fig. 1-p)

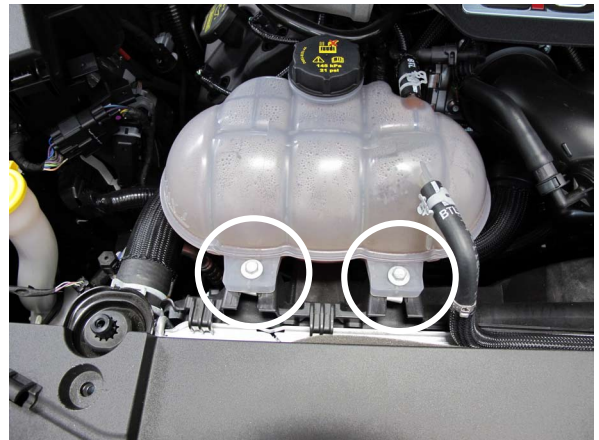

Fig. 1-p: Remove Coolant Reservoir

- Q. Release the upper radiator hose clamp connection to the radiator. Release the quick release upper radiator hose connection to the thermostat housing by pulling the spring clip back and sliding the hose fitting off. Remove the upper radiator hose and set it aside for later modification. Remove the coolant hose to the right of the "Y" fitting, above the thermostat housing & set it aside. It will not be reused.

(See Fig. 1-q)



Fig. 1-q: Remove Upper Radiator Hose

- R. Use a 15mm wrench to rotate the belt tensioner counter-clockwise to release tension from the outer 6-rib accessory drive belt. Remove the belt and set it aside as it will not be reused.

(See Fig. 1-r)



Fig. 1-r: Remove Accessory Drive Belt

1. BASIC COMPONENT REMOVAL, cont'd

- S. Remove the 2x T-20 fasteners securing the MAF insert to the OEM airbox. Remove the MAF insert and set aside for later use.

(See Fig. 1-s)



*Fig. 1-s: MAF Insert
(shown with OEM airbox removed)*

- T. Unplug the electrical connector from the throttle body by sliding the red clip outward and depressing the tab. Remove the 4x 8mm-headed screws securing the throttle body to the intake manifold. These fasteners will not be reused. Remove the throttle body and set it aside for later reinstallation, ensuring that the sealing gasket remains in the intake manifold. Temporarily place a rag in the intake manifold to keep foreign debris from entering the intake manifold.

(See Fig. 1-t)

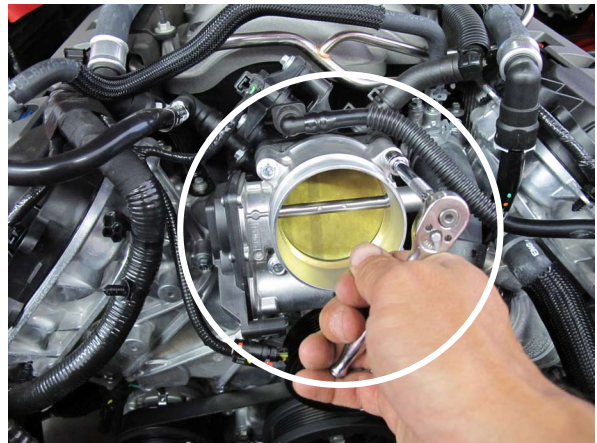

Fig. 1-t: Remove Throttle Body

This page was left intentionally blank.

2. MISCELLANEOUS PREPARATION

- A. Free the large wiring harness from the 2x mounting locations on the engine front cover forward of the passenger side cylinder head. Use extra care when disengaging the lower clip from the threaded hole in the engine cover as this threaded hole will be used in a later step. If part of the clip breaks off in the threaded hole, carefully extract it without damaging the threads. Route the harness higher up along the passenger side valve cover. (See Fig. 2-a)

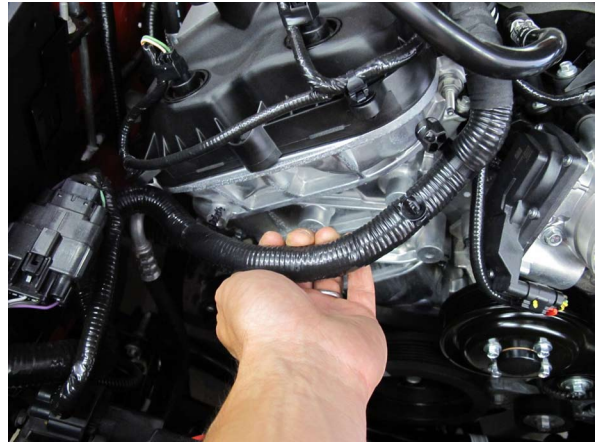

Fig. 2-a: Detach Wiring Harness

- B. Cut off the coolant reservoir mount closest to the drivers side of the vehicle. This is to make room for the new air inlet tube. You may need to make further adjustments when you install the air inlet tube. (See Fig. 2-b)

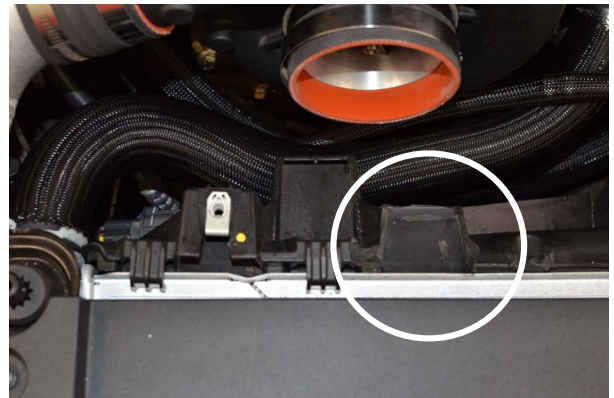

Fig. 2-b: Coolant Reservoir Mount (Removed)

- C. Remove the battery cover by removing the 3x plastic fasteners & pulling the battery cover forward. (See Fig. 2-c)



Fig. 2-c: Remove Battery Cover

2. MISCELLANEOUS PREPARATION, cont'd

- D. If your vehicle is equipped with a strut tower brace, you may remove it at this time.
(See Fig. 2-d)



Fig. 2-d: Remove Strut Tower Brace

- E. Unplug the battery leads.
(See Fig. 2-e)



Fig. 2-e: Unplug Battery Leads

3. SUPERCHARGER ASSEMBLY PREPARATION & INSTALLATION

- A. Using a coarse file or similar tool, remove approximately 1/8" from the front edge of the passenger side valve cover tab. This will ensure proper supercharger-to-valve cover clearance during installation.

(See Fig. 3-a)



Fig. 3-a Modify Tab

- B. Remove the following 3x 10mm-headed screws securing the engine front cover on the passenger side:

- The uppermost screw
- The screw just above the A/C compressor
- The screw between the A/C compressor and the crankshaft

(See Fig. 3-b)

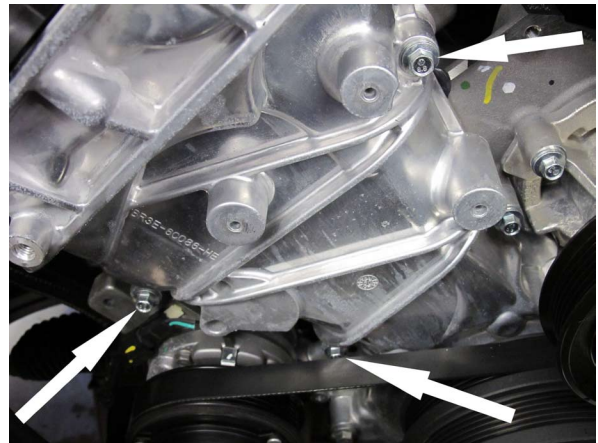

Fig. 3-b: Remove Engine Cover Screws

- C. Inspect the supercharger mounting plate/idler pulley assembly and familiarize yourself with its components and configuration. The new belt should be routed so that the ribbed side engages the ribbed idler pulley and the smooth side rides on the other pulleys. Note the multiple mounting locations of the ribbed idler, used to compensate for different supercharger pulley sizes and belt lengths. All 4x idler mounting bolts should be hand-tight during installation to facilitate alignment.

(See Fig. 3-c)



Fig. 3-c: Inspect Mounting Bracket Assembly

3. SUPERCHARGER ASSEMBLY PREPARATION & INSTALLATION, cont'd

- D. Remove the smooth idler, 1.895" spacer, pilot spacer, 3/8-16 x 3.50" screw & 3/8 AN washer closest to the top of the bracket & set aside for re-use in a later step. Remove the 1.928" spacer, M8 x 80mm screw & 5/16 washer & set aside for re-use in a later step. Remove the 2.058" spacer from the M8 x 100mm button-head screw & set aside for re-use in a later step. Also, discard the provided cone-shaped 1.782" spacer & M8 x 65mm button head screw included in this bracket assembly. They are not required on this model-year vehicle.

(See Fig. 3-d)

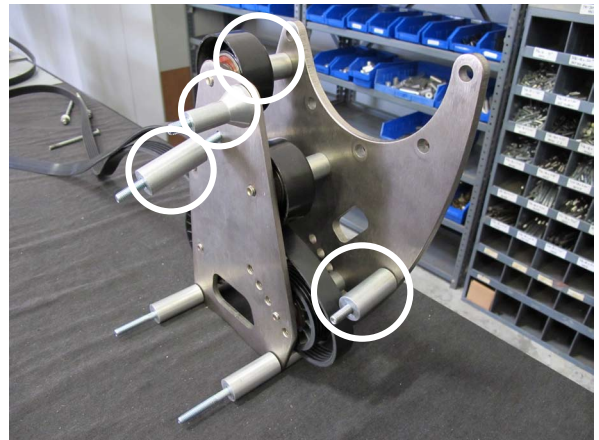

Fig. 3-d: Remove Spacers & Hardware (Circled)

- E. Remove the 2.058" spacer, 2.146" spacer, 2x M8 x 200mm studs, 2x M8 flanged nuts & 2x 5/16" washers & set aside for use in a later step.

(See Fig. 3-e)

NOTE: The 2x 2.730" spacers sandwiched in between the mounting plates (not shown) are held in place by the 2x M8 x 200mm studs. These spacers need to remain in place during installation of the mounting bracket assembly.

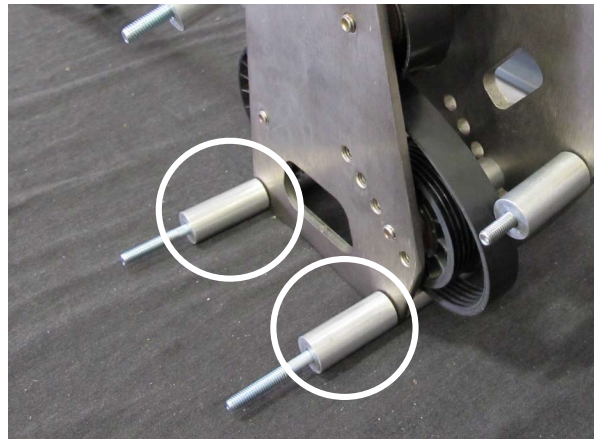

Fig. 3-e: Remove Spacers & Hardware (Circled)

- F. Thread the 2x provided M8 x 200mm studs into the lower 2x engine cover fastener holes, in the locations of the previously-removed fasteners (one just above the A/C compressor and one between the A/C compressor and the crankshaft). Use a small amount of blue thread lock on the threads.

(See Fig. 3-f)

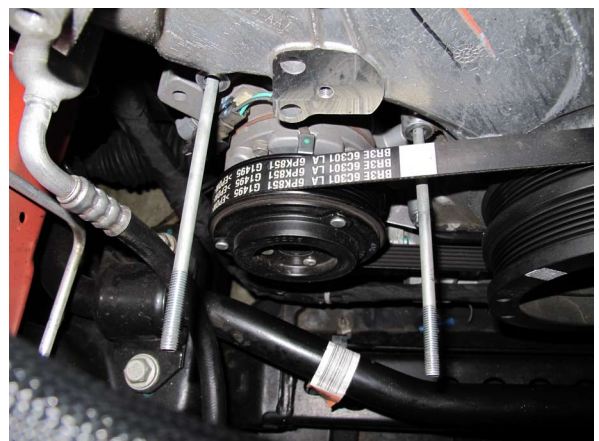

Fig. 3-f: Thread Studs Into Engine Cover Fastener Holes

3. SUPERCHARGER ASSEMBLY PREPARATION & INSTALLATION, cont'd

- G. Slide 1x 2.058" spacer over the stud above the A/C compressor. Slide 1x 2.146" spacer over the stud between the A/C compressor and the crankshaft. Measuring from the face of the spacers (closest to the front of the vehicle), leave 3.75" of the M8 x 200mm stud exposed. (See Fig. 3-g)

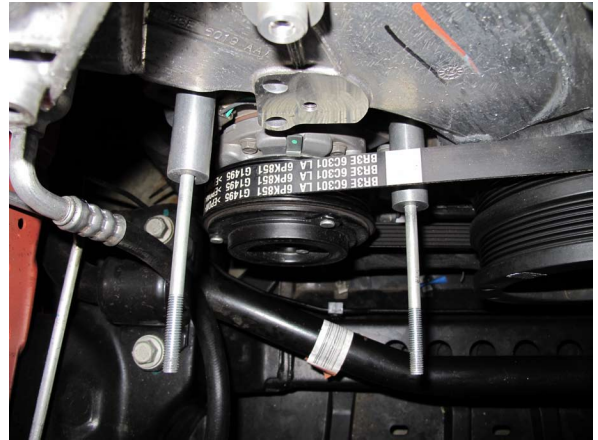

Fig. 3-g: Slide 2.058" & 2.146" Spacers Onto Studs

- H. As mentioned in the note in Step E, the 2x 2.730" spacers sandwiched in between the mounting plates are normally held in place by the 2x M8 x 200mm studs. During the installation of the mounting bracket assembly to the vehicle, make sure that the 2x M8 x 200mm studs pass through the mounting plates & both spacers. (See Fig. 3-h)

NOTE: Slightly tightening the 4x 3/8-16 x 3.50" screws holding the mounting bracket assembly together will trap the 2x 2.730" spacers & help keep them in place while you install the mounting bracket assembly to the vehicle.

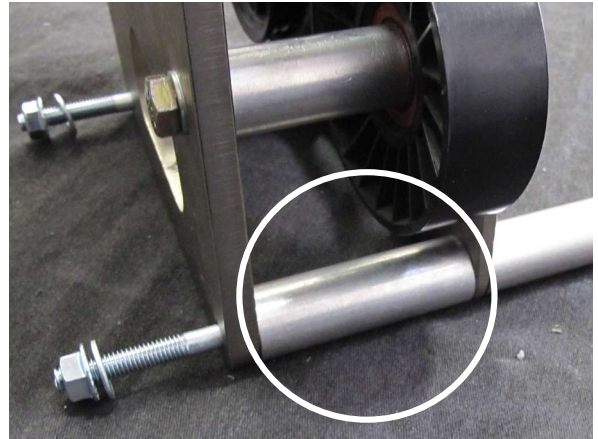

Fig. 3-h: Trap 2x 2.730" Spacers Between Mounting Plates

- I. Position the mounting bracket assembly in the engine compartment, then slide the 2x lower mounting holes onto the 2x M8 x 200mm studs, making sure they pass through both mounting plates & the 2x 2.730" spacers sandwiched in between the mounting plates. (See Fig. 3-i)

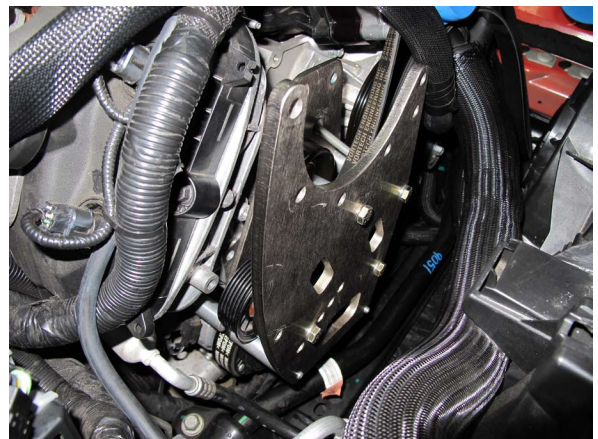

Fig. 3-i: Slide Mounting Bracket Assembly Onto Studs

3. SUPERCHARGER ASSEMBLY PREPARATION & INSTALLATION, cont'd

- J. Locate the previously removed 2.058" spacer & place it between the rear mounting plate & the uppermost engine timing cover hole. Using a 5mm hex tool, secure the M8 x 100mm button head screw to the uppermost engine timing cover hole. (See Fig. 3-j)



Fig. 3-j: Secure Top Of Rear Mounting Plate

- K. Locate the previously removed 1.928" spacer, M8 x 80mm screw & 5/16 washer. Place the spacer in between the front mounting plate & cylinder head. Using the M8 x 80mm screw & 5/16 washer, secure the front plate & spacer to the cylinder head. (See Fig. 3-k)

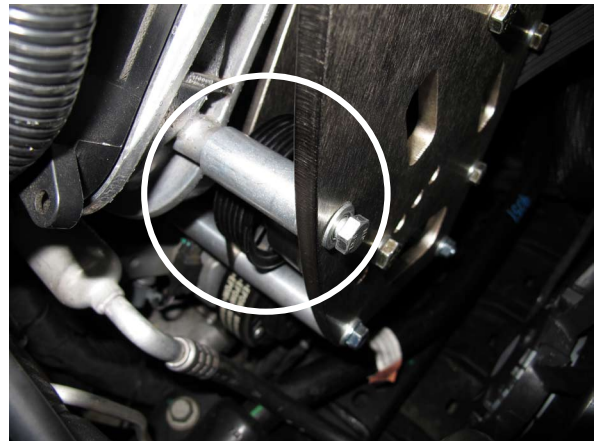

Fig. 3-k: Secure Left Side Of Front Mounting Plate

- L. Locate the previously removed 2x M8 flanged nuts & 2x 5/16 washers & use them to secure the lower section of the bracket to the previously installed 2x M8 x 200mm studs. (See Fig. 3-l)



Fig. 3-l: Secure Lower Mounting Bracket Fasteners

3. SUPERCHARGER ASSEMBLY PREPARATION & INSTALLATION, cont'd

- M. Locate the previously removed smooth idler, 1.895" spacer, pilot spacer, 3/8-16 x 3.50" screw & 3/8 AN washer. Place the smooth idler, 1.895" spacer & pilot spacer into their appropriate location between the mounting plates, then secure with the 1x 3/8-16 x 3.50" screw & 3/8 AN washer. (See Fig. 3-m)



Fig. 3-m: Re-Install Upper Smooth Idler

- N. On the right side of the mounting bracket assembly between the upper & lower smooth idlers, there is a 2.730" spacer secured by a 3/8-16 x 3.50" screw & a 3/8 AN washer. Remove this spacer & hardware & set aside for re-use in a later step. This spacer is temporarily removed to gain better access to 1x of the 5x supercharger mounting screws. (See Fig. 3-n)

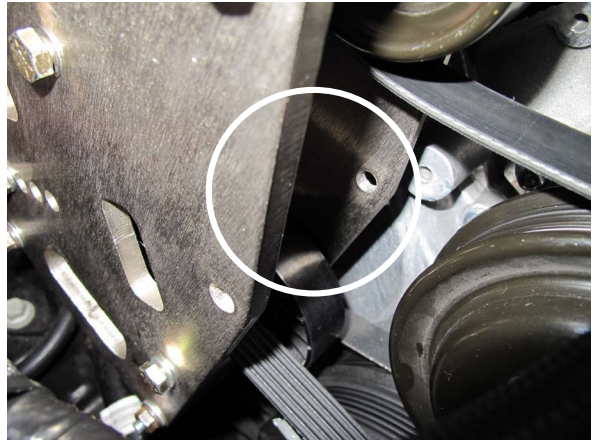

Fig. 3-n: Temporarily Remove Spacer (Circled)

- O. Notice the mounting holes on the front mounting plate. 3x of the screws can be easily accessed. However, the 2x screws that are circled will require the use of a long 9/16" boxed end wrench for ease of installation. (See Fig. 3-o)

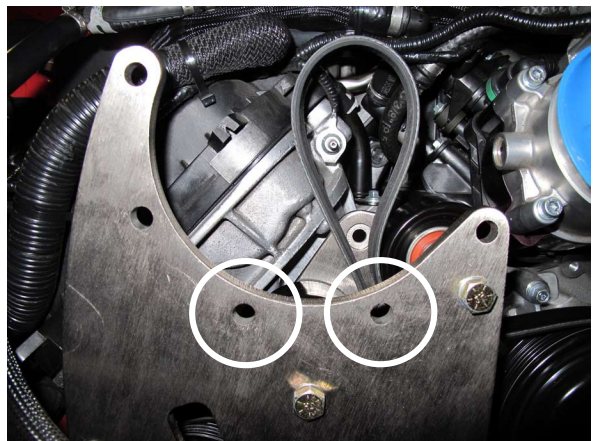

Fig. 3-o: Supercharger Mounting Holes

3. SUPERCHARGER ASSEMBLY PREPARATION & INSTALLATION, cont'd

- P. Prior to installing the supercharger to the mounting bracket assembly, it is suggested that you lubricate the threads in the mounting bosses on the supercharger. To do this, locate the provided 5x 3/8-16 x 1.25" screws, lightly coat the screw threads with lubricant & screw them into the mounting bosses until they bottom out. Once complete, remove the screws from the mounting bosses. This process makes it easier to install the hard to reach supercharger mounting screws.
(See Fig. 3-p)

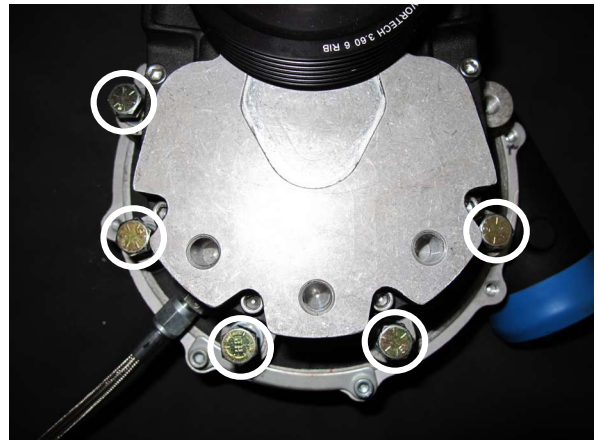

Fig. 3-p: Lubricate Threaded Bosses

- Q. Place the supercharger onto the mounting bracket cradle & begin to thread the 5x 3/8-16 x 1.25" supercharger mounting screws by hand, making sure to use 3/8 AN washers on all 5x screws. Once in position, proceed to tighten all 5x 3/8-16 x 1.25" supercharger mounting screws.
(See Fig. 3-q)

NOTE: Engine Oil Fed Units Only: Locate the included length of black braided 1/2" oil drain hose. Remove the shipping cap from the 1/2" barbed oil drain fitting on the bottom of the supercharger and attach the drain hose with the included #8 worm gear clamp. For oil feed & drain line instructions, proceed to Section 11, then return to Section 4 once complete.



Fig. 3-q: Mount Supercharger To Bracket & Secure

- R. With the supercharger secured to the mounting bracket, proceed to re-install the previously removed 2.730" spacer, make sure that the drive belt runs above & below the spacer. Secure with the previously removed 3/8-16 x 3.50" screw & 3/8 AN washer. At this time, proceed to tighten all mounting bracket hardware.
(See Fig. 3-r)

NOTE: In some cases, you may need to loosen the 2x 3/8-16 x 3.50" screws securing the upper & lower smooth idler to provide enough room to slide the 2.730" spacer back into its original position.

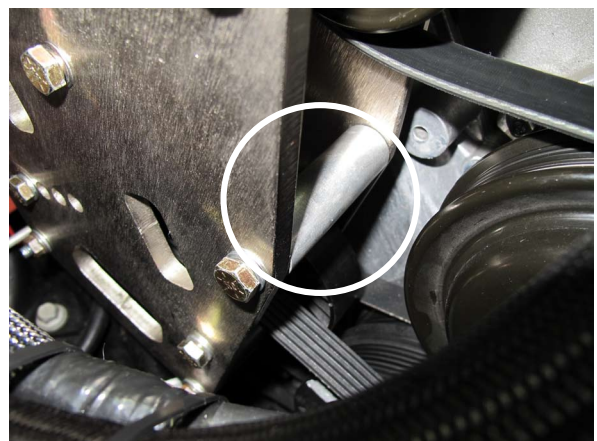

Fig. 3-r: Re-Install Spacer (Circled)

3. SUPERCHARGER ASSEMBLY PREPARATION & INSTALLATION, cont'd

- S. Use the Belt Routing Diagram (Fig. 3.2) on Pg. 20 to route the new drive belt. Once in position, use a 15mm wrench to rotate the belt tensioner counter-clockwise, then slide the new drive belt over the smooth idler on the tensioner. Once the belt is in position & properly routed, release the tension on the belt tensioner.

(See Fig. 3-s)

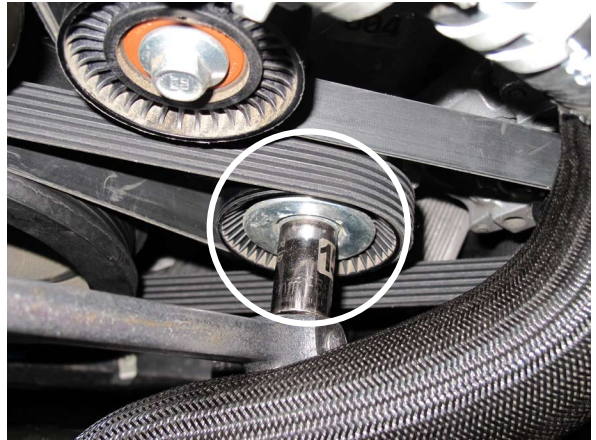

Fig. 3-s: Route Drive Belt

- T. Making sure not to damage the coolant hose, carefully cut the OEM plastic hose clamp on the hose running between the "Y" on the thermostat housing and the engine water neck. Re-secure the hose using the provided #24 hose clamp.

(See Fig. 3-t)



Fig. 3-t: #24 Hose Clamp

- U. Locate the supplied 1.25" black anodized aluminum throttle body spacer. Install the included large O-ring into the groove in the spacer. This O-ring seals against the throttle body & the smooth side of the spacer seals against the OEM O-ring in the intake manifold.

(See Fig. 3-u)



Fig. 3-u: Place O-Ring In Anodized Spacer

3. SUPERCHARGER ASSEMBLY PREPARATION & INSTALLATION, cont'd

- V. If you used a rag to temporarily cover the intake manifold opening, remove it at this time. Check the O-ring for any damage. If all looks well, clean the throttle body mounting surface of any foreign debris.

(See Fig. 3-v)



Fig. 3-v: Clean T-Body Flange & Verify O-Ring Placement

- W. Reinstall the throttle body, rotated 180° from its original orientation (upside-down), using this spacer, the 4x included M6 x 80mm socket head cap screws & 4x included 6mm washers. Ensure that both O-ring seals stay in place. Carefully snip the strip of tape securing the throttle body electrical harness to the connector housing. Reconnect the connector to the throttle body. Route the large wiring harness near the passenger side valve cover, throttle body electrical harness & any other items away from moving parts and sharp edges and secure.

(See Fig. 3-w)

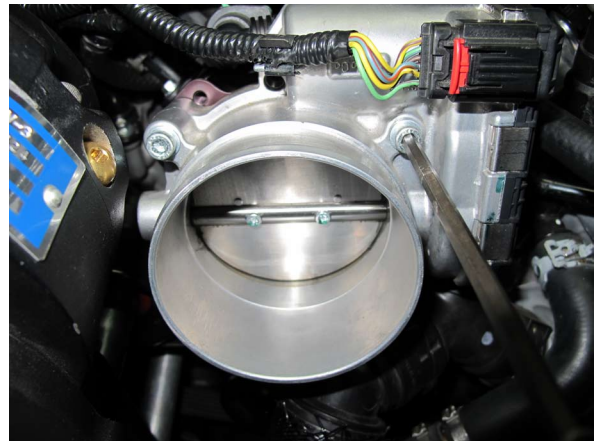

Fig. 3-w: Re-Install T-Body 180° From Original Orientation

3. SUPERCHARGER ASSEMBLY PREPARATION & INSTALLATION, cont'd

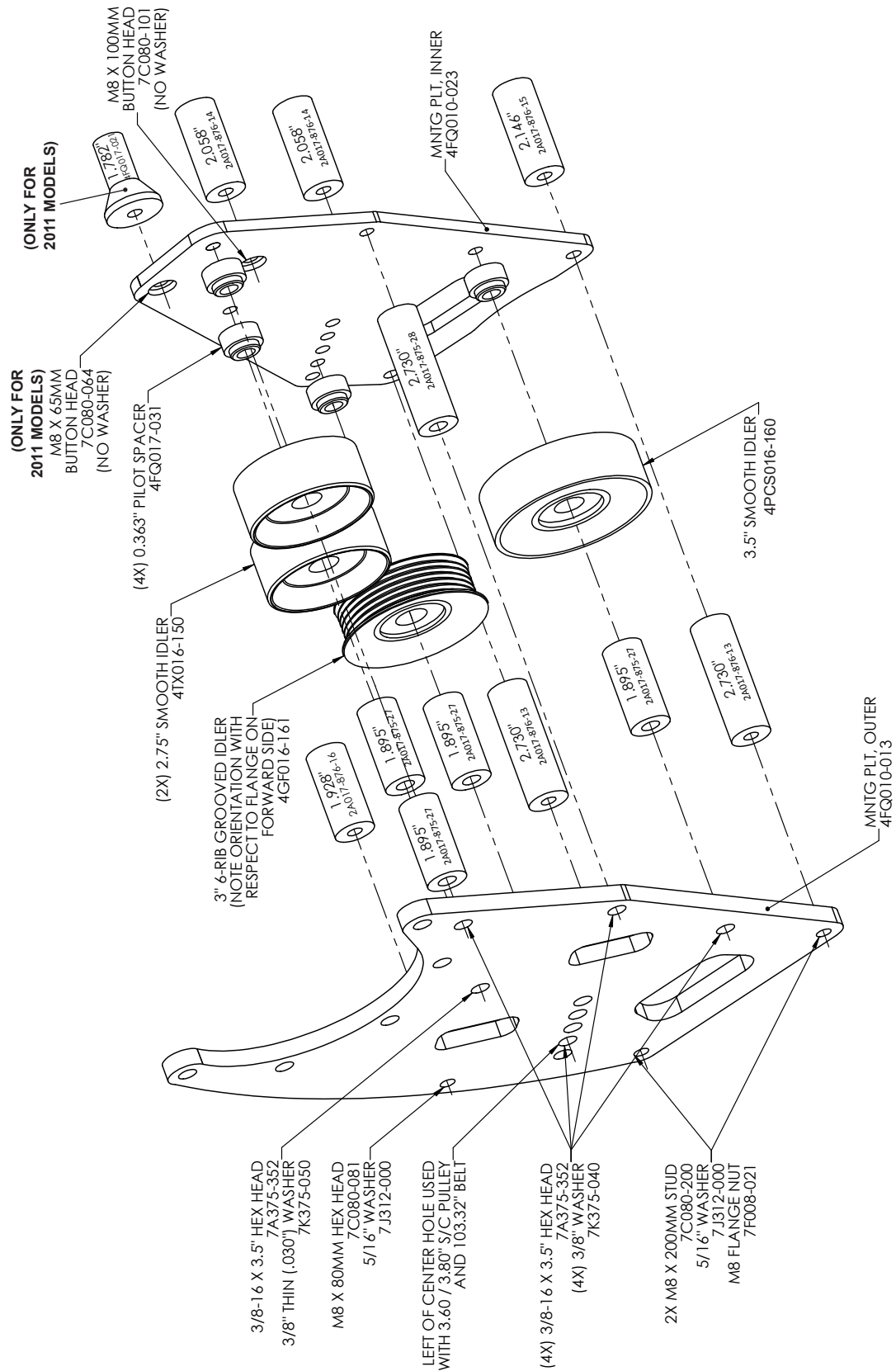

FIG 3.1 - MOUNTING BRACKET ASSEMBLY DIAGRAM

3. SUPERCHARGER ASSEMBLY PREPARATION & INSTALLATION, cont'd

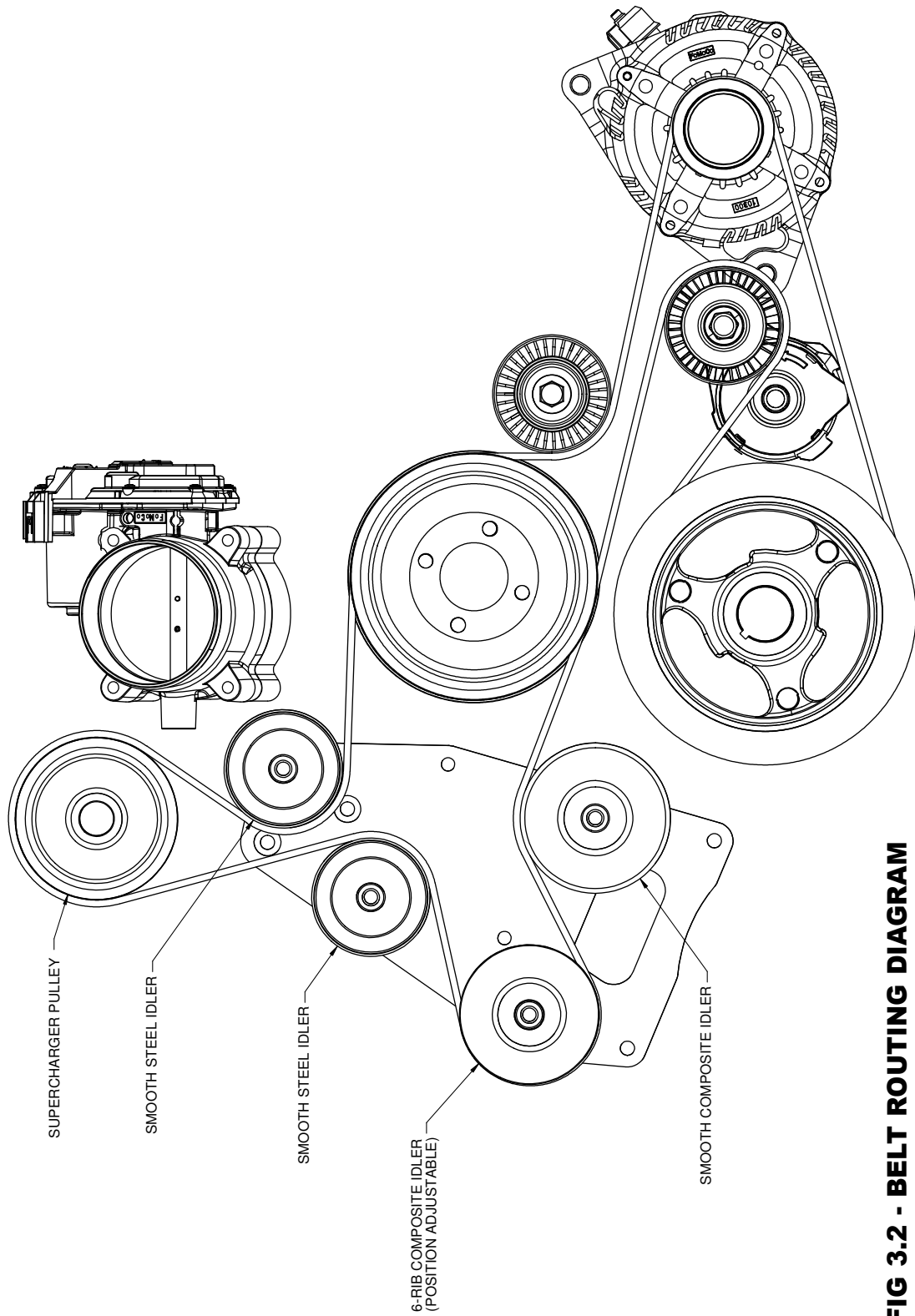

FIG 3.2 - BELT ROUTING DIAGRAM

4. PCV SYSTEM MODIFICATION

- A. Use a razor blade to carefully slit each end of the plastic tube until it can be split away from the barbed fittings inside. Take care not to damage the fittings.
(See Fig. 4-a)



Fig. 4-a: OEM Passenger Side PCV Hose (Fittings Removed)

- B. Locate the supplied PCV valve, 5/8" to 3/8" brass reducer, 90° 5/8" fitting, 5/8" hose & 3/8" hose. Assemble the passenger side breather assembly as shown. Note that the hose lengths are called out in Fig. 4-b. The 3/8" hose is secured with 2x #17 stepless clamps. The PCV valve is secured to the 5/8" hose using 1x #28.6 stepless clamps while the remaining 5/8" fittings are secured using #25.6 stepless clamps.
(See Fig. 4-b)

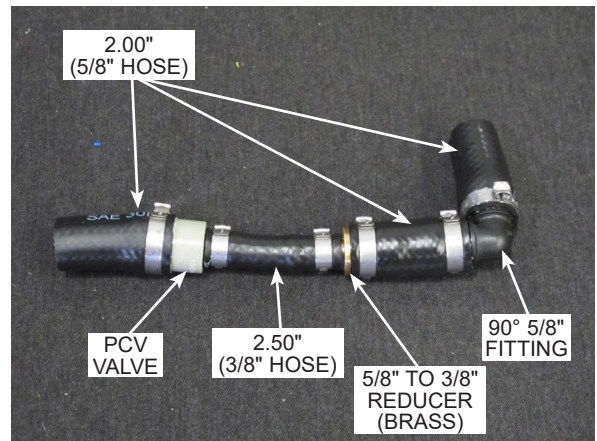

Fig. 4-b: PCV Assembly Layout

- C. Test fit the assembly as shown. Clock the assembly as needed for clearance to the supercharger pulley. Once in position, remove the assembly & secure the stepless clamps, then wrap the assembly with the provided flex braid sleeve & shrink wrap.
(See Fig. 4-c)



Fig. 4-c: Modified Passenger Side PCV Hose

This page was left intentionally blank.

5. CHARGE AIR COOLER & DISCHARGE TUBE INSTALLATION

- A. Prior to installing the cooler, the radiator shrouds will need to be modified as shown.

(See Fig. 5-a)

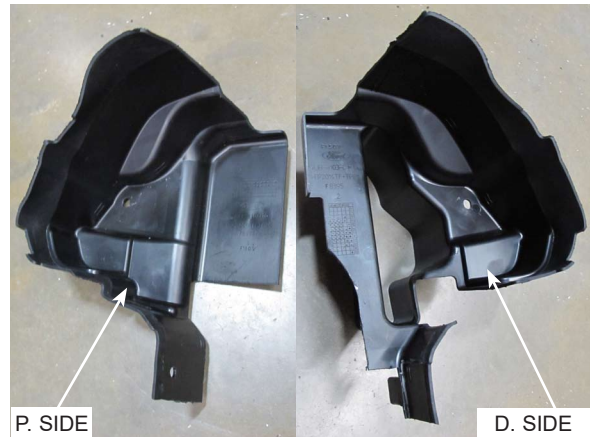

Fig. 5-a: Modified Radiator Shrouds

- B. Back out the 4x inner-most screws of the bumper support, leaving about 1/2" of the screw protruding from the back side. **Vehicles equipped with the Ford Performance Pack will need to remove the 4x nuts securing the brace to the back side of the bumper support prior to backing out the screws.** Raise the cooler into position, making sure to align the cooler brackets to the 4x screws previously backed out. Once aligned, begin to thread the screws through the cooler brackets. Route the wire harness along the top side of the bumper support. Attach the ambient air temp sensor back to its factory location & plug in the electrical connector.

(See Fig. 5-b)

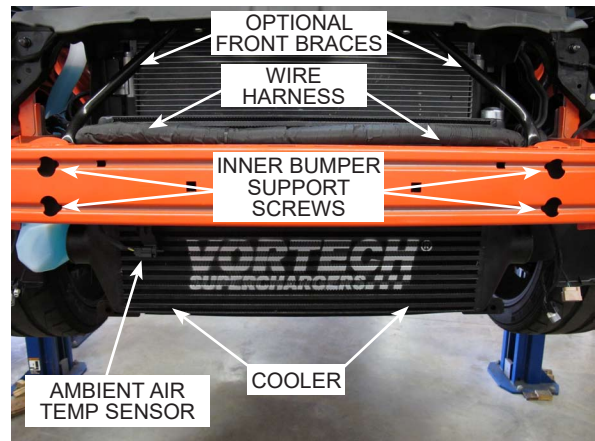

Fig. 5-b: CAC Installation

- C. If your vehicle is not equipped with the optional front braces, proceed to install the cooler against then bumper support, then secure with the provided M8 x 1.25 flanged nuts & 5/16 washers. Vehicles equipped with the optional front braces, reuse the factory hardware, making sure the cooler bracket is sandwiched between the lower brace mounts & bumper support.

(See Fig. 5-c)

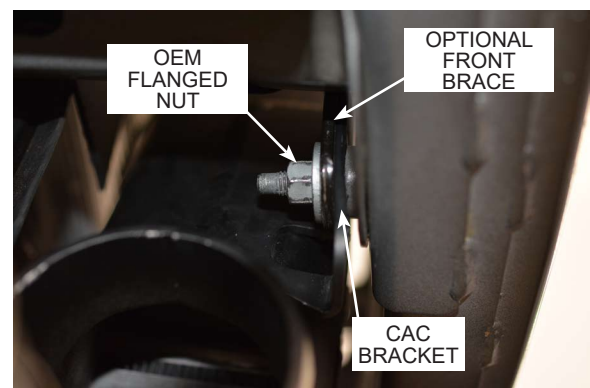

Fig. 5-c: CAC Installation - Vehicles w/ Front Braces

5. CHARGE AIR COOLER & DISCHARGE TUBE INSTALLATION, cont'd

- D. Remove the 10mm-headed fastener securing the air box, then remove the air box from the vehicle. Remove the snorkel from the air box & set aside. It will not be reused.

(See Fig. 5-d)



Fig. 5-d: Remove Air Box

- E. Install a straight 3" silicone sleeve & 2x #48 hose clamps to the passenger side of the cooler. Install a 3" silicone bump sleeve & 2x #48 hose clamps to the end of Tube B with the smaller bend. Slide the open end of Tube B into the silicone coupler on the cooler. For proper clearance between the body of the vehicle & the windshield washer reservoir, you will need to bend the steel tab, closest to the bypass valve flange, towards the front of the vehicle.

(See Fig. 5-e)

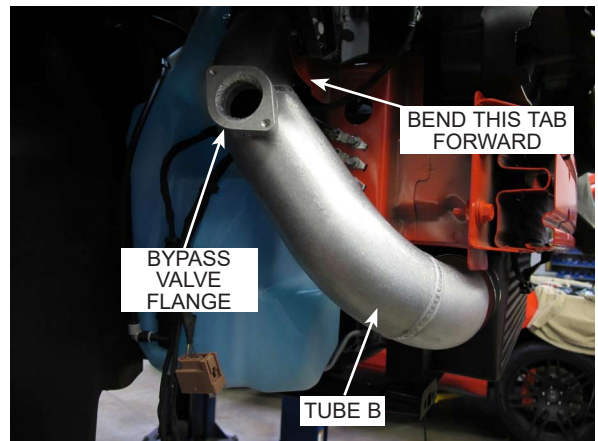

Fig. 5-e: Tube B Installation

- F. Install the 3.00"-2.75" silicone bump reducer sleeve to the volute. The volute end of the sleeve uses a #44 hose clamp, while the tube end uses a #48 hose clamp. Install Tube A & clock it accordingly.

(See Fig. 5-f)

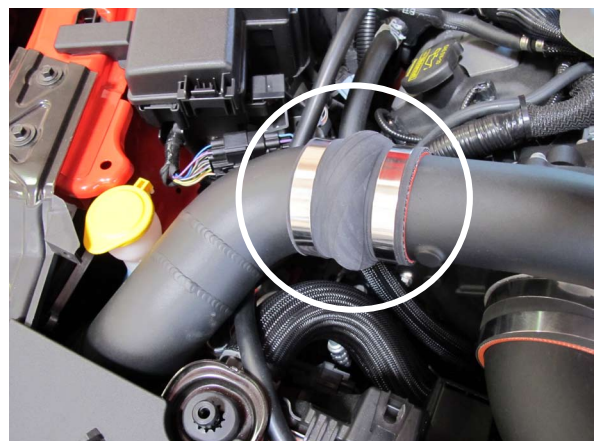

Fig. 5-f: Tube A Installation

5. CHARGE AIR COOLER & DISCHARGE TUBE INSTALLATION, cont'd

- G. Make sure Tube A is clocked in a manner to clear the windshield washer reservoir.

(See Fig. 5-g)



Fig. 5-g: Windshield Reservoir Clearance

- H. With tubes A & B in place, attach the bypass valve with the supplied hardware & gasket to the bypass valve flange on Tube B. Make sure that the opening of the bypass valve is facing towards the back of the vehicle. Once secured, attach the supplied 1" filter to the bypass valve & tighten the supplied hose clamp.

(See Fig. 5-h)

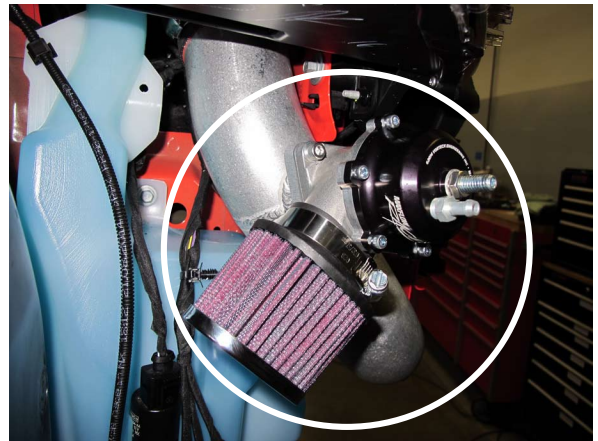

Fig. 5-h: Bypass Valve Mounting

- I. Install the 3.50"-3.00" reducer sleeve to the driver side of the cooler. Secure the cooler end of the reducer sleeve with a #48 hose clamp. Locate Tube C, which has two 90° bends, and slide it into the silicone sleeve on the cooler & secure with a #56 hose clamp. Install a 3.50" silicone sleeve & 2x #56 hose clamps onto the open end of the Tube C.

(See Fig. 5-i)

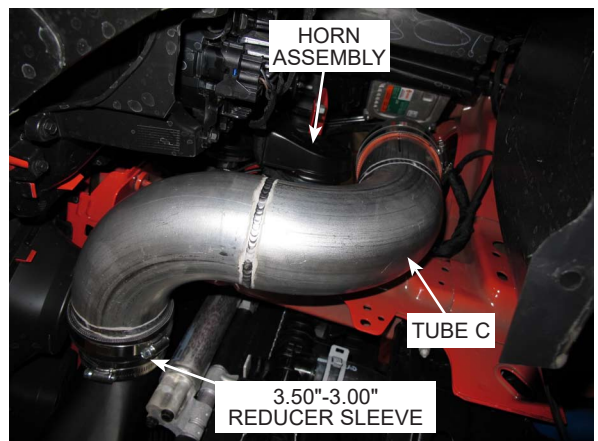

Fig. 5-i: Tube C Installation

5. CHARGE AIR COOLER & DISCHARGE TUBE INSTALLATION, cont'd

- J. Make sure that Tube C is clear of the horn. You may need to relocate the horn wiring harness to keep it from resting against Tube C.
(See Fig. 5-j)



Fig. 5-j: Horn Clearance

- K. Locate Tube D & insert the one end of the tube into the silicone sleeve previously attached on Tube C. Attach the supplied 4.00"-3.50" silicone reducer sleeve & #56 hose clamp to the other end of Tube D, then install the MAF housing. Be sure to have the "FLOW" arrow on the MAF flange facing towards the throttle body.
(See Fig. 5-k)

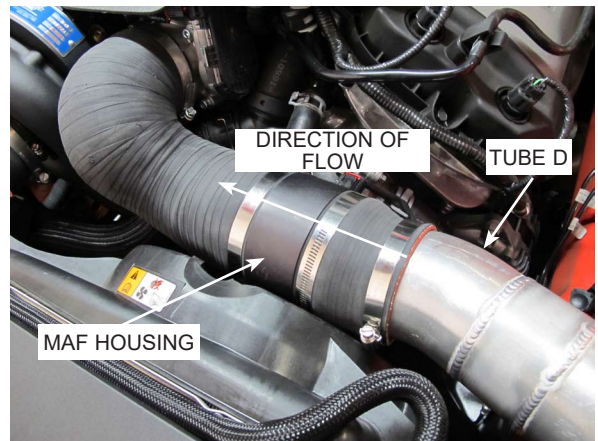

Fig. 5-k: Tube D & MAF Housing Installation

- L. Attach the throttle body sleeve & #56 hose clamp to the throttle body, then attach the other end of the sleeve to the MAF housing. Use 2x #64 hose clamps to secure the MAF housing. Once in place, insert the MAF sensor into the flange & secure with the provided M4-.7 x 8mm screws. Connect the MAF plug to the sensor. Verify that all tubes are free of any obstructions then proceed to tighten all of the hose clamps.
(See Fig. 5-l)

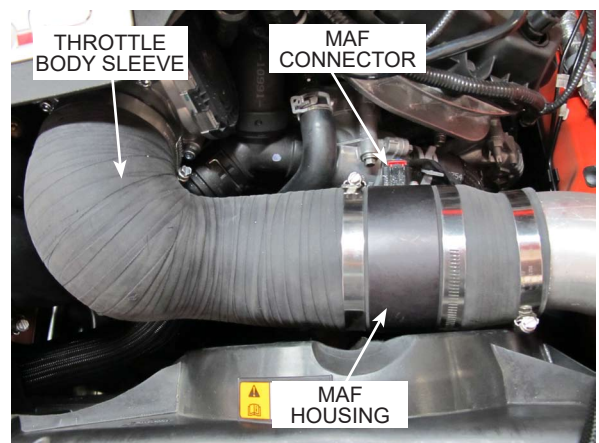

Fig. 5-l: Throttle Body Sleeve Installation

5. CHARGE AIR COOLER & DISCHARGE TUBE INSTALLATION, cont'd

- M. Trimming of the air box lid may be required to clear the discharge tube. Trim as necessary.
(See Fig. 5-m)

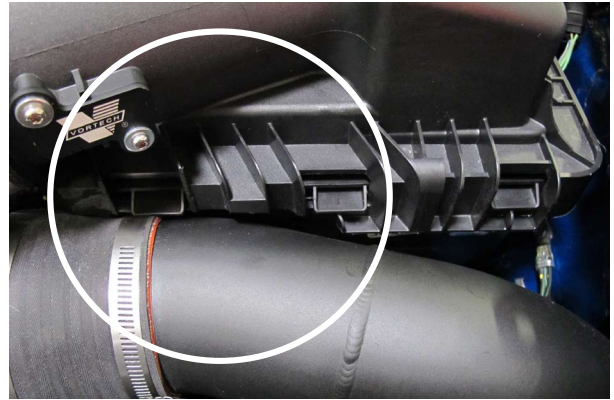

Fig. 5-m: Trimmed Air Box Lid

- N. Due to vehicle variances, slight trimming of the hood liner may be required for proper clearance between the hood & the supercharger volute. Trim area as necessary.
(See Fig. 5-n)



Fig. 5-n: Hood Liner

- O. **8-Rib / V-7 Only:** The supercharger bracket included in 8-Rib systems positions the supercharger approximately 1/4" further forward than a 6-rib drive system. This may cause interference with the bottom of the OEM hood liner and in some cases the OEM hood. In addition, using a V-7 supercharger with an 8-rib system may require further clearance due to the larger size of the volute. Vortech suggests placing a few strips of modeling clay on the top of the supercharger volute, then carefully lower the hood, making sure it does not latch shut. Lift the hood & make note of the underhood area that may need to be modified, then clearance as necessary.
(See Fig. 5-o)



Fig. 5-o: Modeling Clay

This page was left intentionally blank.

6. FUEL INJECTOR REPLACEMENT

- A. Disconnect the fuel feed line from the fitting near the driver side fuel rail.

(See Fig. 6-a)

NOTE: The fuel line may be pressurized.
Take care to avoid spray and spills.

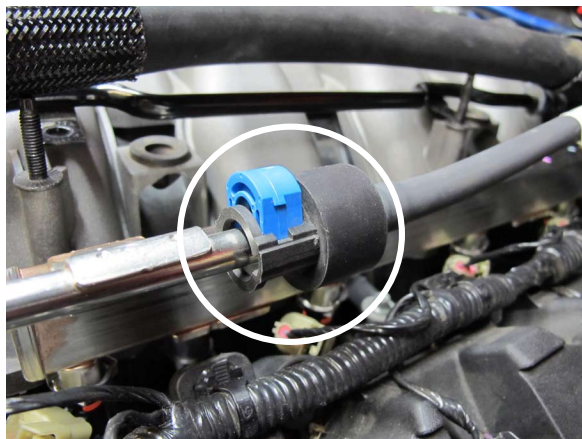

Fig. 6-a: Disconnect Fuel Feed Line

- B. Remove the 4x 10mm hex nuts securing the plastic heater hose guides and set the guides aside for later reinstallation. Reposition the vacuum tube assembly mounted under the driver side heater hose guide to facilitate fuel rail removal. Remove the foam insulation from each fuel rail (2x pieces total). Unplug each of the 8x fuel injector electrical connectors.

(See Fig. 6-b)



Fig. 6-b: Hose Guide Removal

- C. Remove the 4x 10mm-headed screws securing the fuel rails to the intake manifold (2x per side). Lift the fuel rails (with injectors attached) up and away from the engine, taking care not to spill fuel from the feed fitting. Drain the fuel from the rails.

(See Fig. 6-c)



Fig. 6-c: Remove Fuel injector Rail Assembly

6. FUEL INJECTOR REPLACEMENT, cont'd

- D. Locate the 4x OEM aluminum fuel rail spacers lightly pressed into the intake manifold and pull them free. Replace them with the supplied shorter fuel rail spacers and insert them into the intake manifold in place of the OEM spacers.

(See Fig. 6-d)



Fig. 6-d: Aluminum Fuel Rail Spacers

- E. Note the orientation of the OEM injectors in the fuel rails. Disengage the retaining clips and remove the OEM injectors. Install the supplied high-flow injectors into the fuel rails in the same orientation as the OEM injectors and secure in the original fashion with the OEM retaining clips.

(See Fig. 6-e)



Fig. 6-e: Fuel Rail / Injector Assembly Detail

- F. Install the rail/injector assembly into the intake manifold. Secure the fuel rails with the 4x included M10 x 90mm socket head cap screws with washers. Connect the fuel injector electrical connectors to each of the 8x injectors. Place the foam insulation back over each fuel rail. Place the vacuum tube assembly back into position on the studs near the driver side fuel rail. Reinstall the plastic heater hose guides and secure with the OEM 10mm hex nuts. Route the heater hoses over them in the OEM fashion. Reconnect the fuel feed line to the fitting on the fuel rail assembly. Make sure it is securely connected in the OEM fashion.

(See Fig. 6-f)

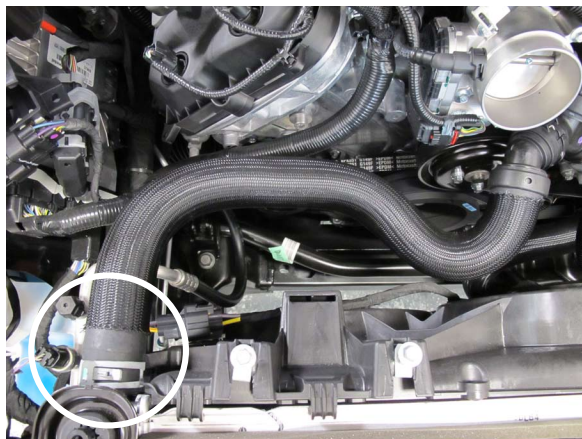

Fig. 6-f: Re-securing Fuel Rails

7. ENGINE COOLING SYSTEM MODIFICATION

- A. Locate the previously-removed OEM upper radiator hose. Remove the factory spring clamp & set aside. Cut off 2" from the end of the hose.

(See Fig. 7-a)



*Fig. 7-a: Upper Radiator Hose
(OEM Configuration)*

- B. Cut away the OEM plastic hose clamp on the quick-release end of the radiator hose, taking care not to damage the hose. Separate the hose from the quick-release fitting, then cut 1" off of the end of the hose.

(See Fig. 7-b)



Fig. 7-b: Cut Plastic Hose Clamp

- C. The upper radiator hose will need to be flipped when re-installed on the vehicle in order to provide adequate space between the upper radiator hose & the supercharger. The end of the hose originally attached to the quick-release fitting will now be attached to the upper radiator inlet. The opposite end will now be attached to the quick-release fitting.

(See Fig. 7-c)



*Fig. 7-c: Upper Radiator Hose
(New Configuration)*

7. ENGINE COOLING SYSTEM MODIFICATION, cont'd

- D. Once both ends of the hose are attached & properly clocked, secure the radiator-side of the hose using the previously removed spring clamp. Use the supplied #24 hose clamp on the quick-release side of the hose.

(See Fig. 7-d)

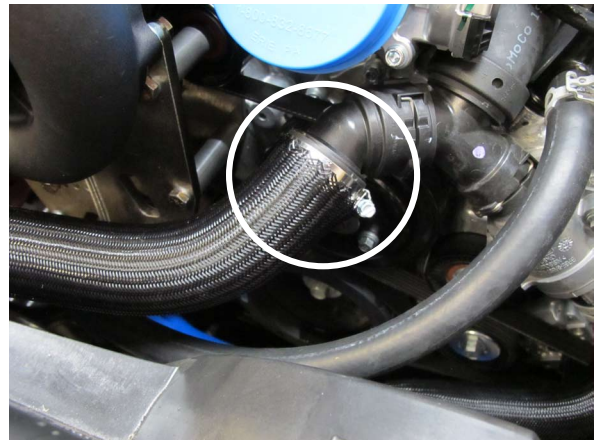

Fig. 7-d: #24 Hose Clamp

- E. To the right of the passenger side shock tower you will see a ground strap for the electric power steering system. Remove the 8mm-headed fastener securing the ground strap & relocate this ground strap to the harness mount directly below the original mounting location for this ground strap. Re-use OEM hardware.

(See Fig. 7-e)

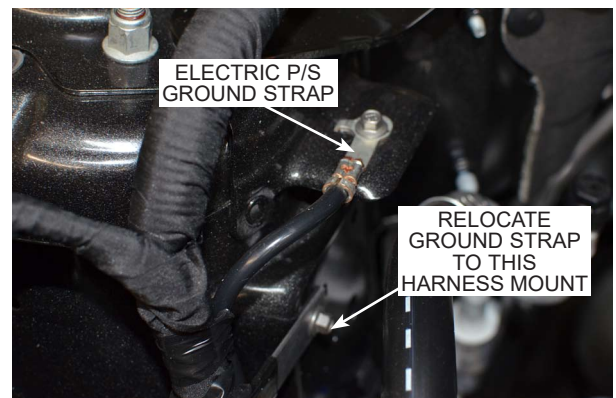

Fig. 7-e: Ground Strap Relocation

- F. Remove the 13mm-headed screw on the brace to the right of the battery & attach the new coolant reservoir as shown.

(See Fig. 7-f)

NOTE: Base model vehicles will need to modify the section pointed out in Fig. 7-f for proper fitment of the coolant reservoir.

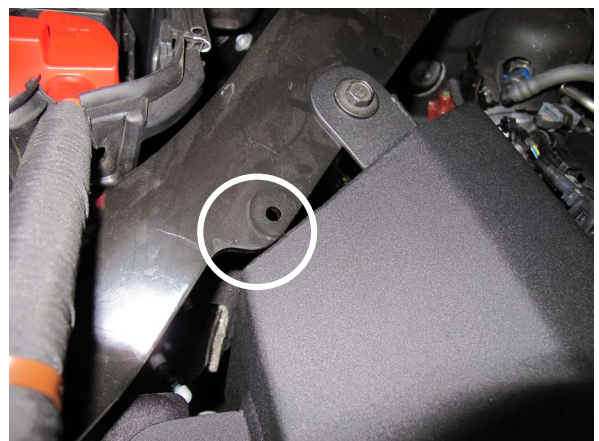

Fig. 7-f: Coolant Reservoir Mount #1

7. ENGINE COOLING SYSTEM MODIFICATION, cont'd

- G. The second mount of the coolant reservoir will be mounted where the electric power steering ground strap was previously attached. Reuse the 8mm-headed fastener to fasten the coolant reservoir. (See Fig. 7-g)



Fig. 7-g: Coolant Reservoir Mount #2

- H. Locate the included 3/8" hose and cut a 2" piece. Install the piece onto the hose barb on the replacement coolant reservoir and secure with an included #17 stepless clamp. (See Fig. 7-h)



Fig. 7-h: Ø3/8" x 2" Hose

- I. Slide another #17 stepless clamp onto the 2" piece and then insert the black plastic TEE as shown, so one leg points forward and one points to the driver side. Secure with the #17 stepless clamp. (See Fig. 7-i)



Fig. 7-i: Ø3/8" x 2" Hose + 3/8" Tee

7. ENGINE COOLING SYSTEM MODIFICATION, cont'd

- J. Locate the small coolant hose running from the driver side front of the engine previously disconnected from the OEM coolant reservoir. Cut off the molded bends of the hose.
(See Fig. 7-j)



Fig. 7-j: Small Coolant Hose

- K. Use the included 5/16" hose, 5/16" barbed hose unions, and #15.7 stepless clamps to extend the upper coolant hose along the top of the engine. Route the hose under the large wiring harness and secure away from moving parts and sharp edges. Trim to length and secure the hose to the plastic TEE using the #15.7 stepless clamps.
(See Fig. 7-k)



Fig. 7-k: Small Coolant Hose

- L. Locate the coolant overflow hose running along the top of the radiator (previously disconnected from the OEM coolant reservoir). Pull back the abrasion sleeve and cut off the molded elbows of the hose. Use the included 3/8" hose, 3/8" barbed hose union, and #17 stepless clamps to extend the coolant overflow hose along the top of the radiator, under discharge tube and around to the area of the replacement coolant reservoir. Secure using #17 stepless clamps.
(See Fig. 7-l)

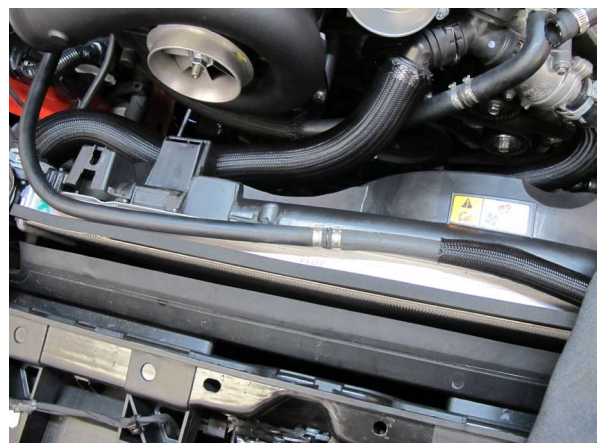

Fig. 7-l: Coolant Overflow Hose Cut & Splice

7. ENGINE COOLING SYSTEM MODIFICATION, cont'd

- M. Trim the 3/8" hose to length & secure it to the plastic TEE using a #17 stepless clamp.
(See Fig. 7-m)

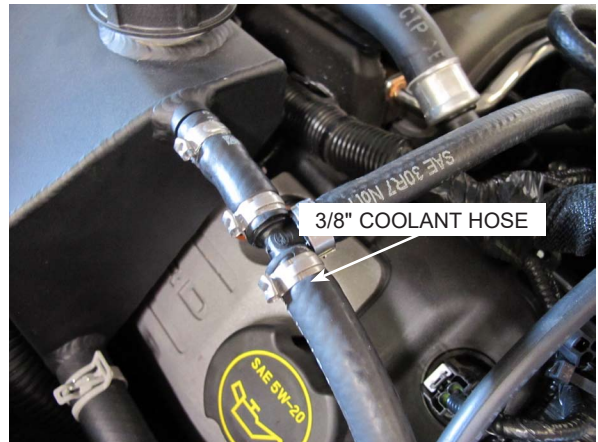

Fig. 7-m: Coolant Overflow Hose

- N. Locate the provided 3/4" 90° hose elbow, 3/4" brass hose union & 2x 28.6 stepless clamps. Slide the hose union into one end of the hose elbow & the other end into the length of provided 3/4" hose. Use the 2x 28.6 stepless clamps to secure the hoses to the brass hose union. Attach the other end of the hose elbow to the drivers side heater tube & secure with the OEM hose clamp.
(See Fig. 7-n)



Fig. 7-n: 3/4" 90° Hose Elbow

- O. Route the open end of the new 3/4" coolant hose (with OEM abrasion sleeve attached) across the front of the motor & attach to the new coolant reservoir on the passenger side. Use zip ties to secure the 3/4" coolant hose to the upper radiator hose.
(See Fig. 7-o)



Fig. 7-o: 3/4" Coolant Hose Routing

7. ENGINE COOLING SYSTEM MODIFICATION, cont'd

- P. Attach the provided length of 7/64 rubber hose to the brass fitting next to the threaded bung & route it towards the bottom of the vehicle. Refill the engine cooling system via the replacement coolant reservoir with the previously-drained coolant. Filter if needed, ensuring no contaminants enter the cooling system. The coolant reservoir should be approximately 1/2 full. Do not overfill. Close the reservoir with the OEM cap from the OEM coolant reservoir.

(See Fig. 7-p)

NOTE: Periodically check the coolant level once the car is running & the cooling system purges.



Fig. 7-p: 3/4" Coolant Reservoir

8. AIR INLET ASSEMBLY INSTALLATION

- A. Trimming of the OEM air box lid may be required to clear the discharge tube. Trim as necessary, then proceed to install the OEM air box assembly back into the vehicle & secure using the OEM fastener.

(See Fig. 8-a)

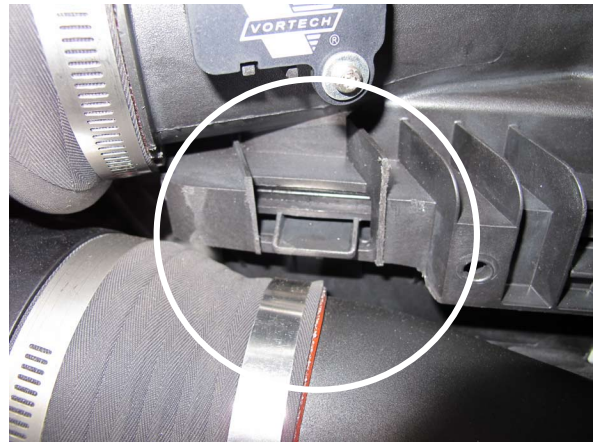

Fig. 8-a: Trimmed Air Box Lid

- B. Locate the provided air inlet duct. Using the provided $\text{\O}4.00''$ to $\text{\O}3.50''$ silicone reducer sleeve, loosely attach the air inlet duct to the supercharger air inlet. Next, locate the provided $\text{\O}4.00''$ silicone bump sleeve & $\text{\O}3.75 \times 1.00''$ length silicone ring adapter. Attach the silicone ring adapter to the OEM air box inlet (this is done for proper fitment of the $\text{\O}4.00''$ silicone bump sleeve), then use the $\text{\O}4.00''$ silicone bump sleeve to join the air inlet duct to the OEM air box. Loosely secure using the provided hose clamps.

(See Fig. 8-b)

NOTE: If your kit is equipped with a V-7 supercharger, use the $\text{\O}4.00 \times 2.00''$ length silicone sleeve in place of the $\text{\O}4.00$ to $\text{\O}3.50$ reducer sleeve. Also, use a #64 hose clamp in place of the #56 hose clamp.



Fig. 8-b: Attach Air Inlet Duct To Air Box

- C. For the next few steps, we suggest leaving the air inlet assembly hose clamps loose, as you will be fitting various lengths of hose to the provided air inlet duct.

(See Fig. 8-c)



Fig. 8-c: Leave Air Inlet Assembly Loose At This Time

8. AIR INLET ASSEMBLY INSTALLATION, cont'd

NOTE: Vehicles equipped with recirculating Intake Manifold Runner Control solenoids as seen in Fig. 8-d, proceed to Step D. Vehicles equipped with vented Intake Manifold Runner Control solenoids as seen in Fig. 8-p on Pg. 43, proceed to Step P.

- D. If your vehicle is equipped with recirculating vents on the Intake Manifold Runner Control solenoids as seen in Fig. 8-d, you will need to reference the Vacuum Routing Diagram (Fig. 8.1) located on Pg. 42 for proper installation.

(See Fig. 8-d)



Fig. 8-d: Recirculating IMRC Solenoids

- E. Remove the protective cover from the OEM dual check valve assembly. The following hoses will need to be removed from the dual check valve assembly:

a. Remove the hard plastic vacuum hose from the dual check valve assembly by slicing it the end with a razor blade. The other end of the hose is connected to a hard plastic tube with another check valve that runs beneath the passenger side of the intake manifold. Slice the hose at the check valve & remove it from the hard plastic tube.

b. Remove breather hose "A" from the dual check valve assembly. It will not be reused.

c. Remove breather hose "B" from the hard plastic tube that runs beneath the drivers side of the intake manifold.

(See Fig. 8-e)

- F. With the hoses removed, you should be left with the ports on the left side of the dual check valve exposed.

(See Fig. 8-f)

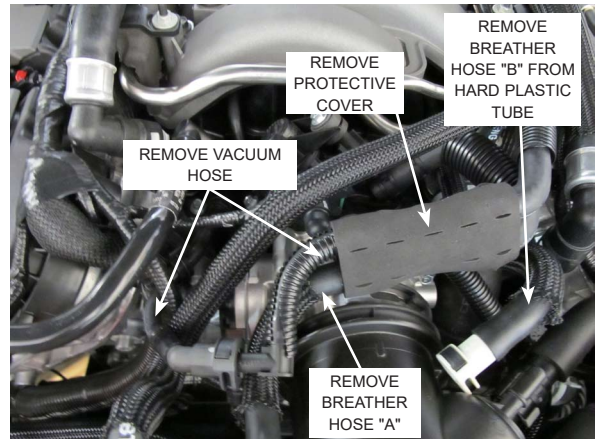

Fig. 8-e: Dual Check Valve Assembly

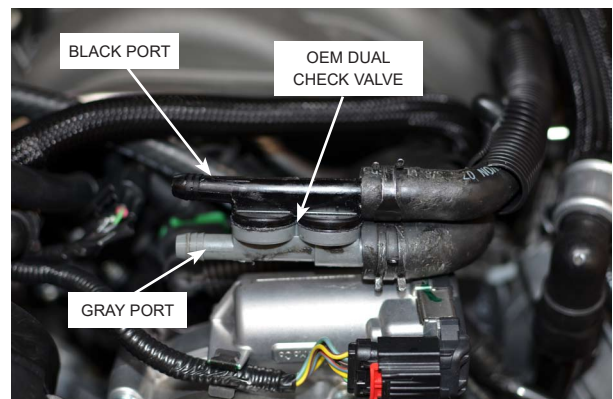

Fig. 8-f: Dual Check Valve Assembly (Hoses Removed)

8. AIR INLET ASSEMBLY INSTALLATION, cont'd

- G. Cut a piece of 3/8" hose, roughly 1.5" in length, & attach it to the open end of the hard plastic tube that runs beneath the drivers side of the intake manifold. Route the hose under the fuel rail cross over tube. Insert the provided 3/8" plastic tee into the open end of the 3/8" hose.

(See Fig. 8-g)

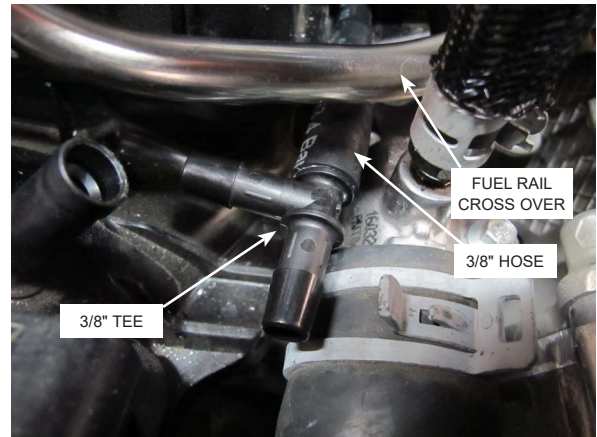

Fig. 8-g: 3/8" Hose & Tee Attached to Hard Plastic Tube (Drivers Side)

- H. Cut a 12" section & 2.5" section of 3/8" hose. Locate the provided 3/8" check valve & assemble it as shown in Fig. 8-e. Note the direction of flow on the check valve. Secure the check valve with 2x 17.0 stepless clamps.

(See Fig. 8-h)

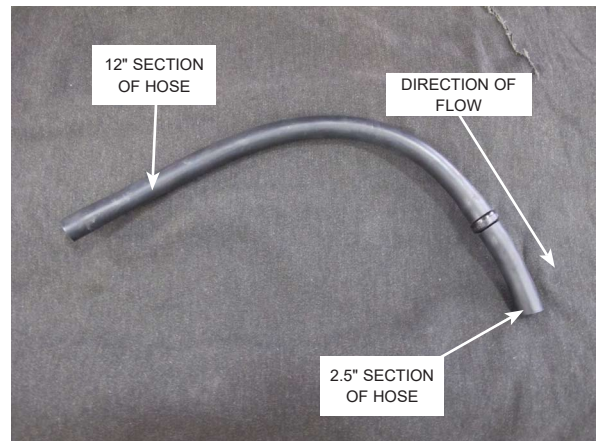

Fig. 8-h: Hose Arrangement w/Provided Check Valve

- I. Attach the long section of 3/8" hose to the previously installed 3/8" plastic tee, then attach the short section of hose to the gray port on the dual check valve assembly. The arrow on the provided check valve should be pointing toward the gray port of the dual check valve.

(See Fig. 8-i)

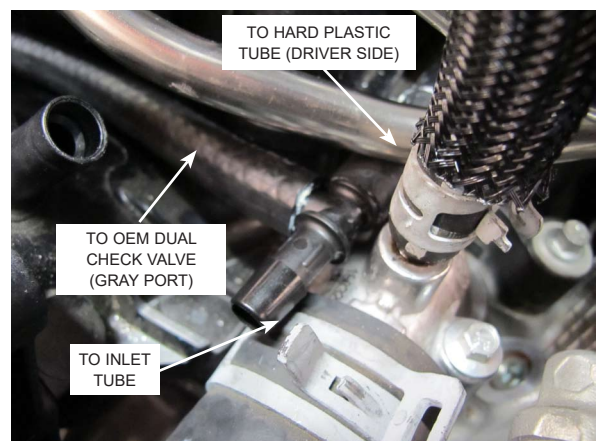

Fig. 8-i: Long Section Of 3/8" Hose Attached To Tee (Reference)

8. AIR INLET ASSEMBLY INSTALLATION, cont'd

- J. Attach a length of 3/8" hose to the other hard plastic tube which runs underneath the passenger side of the intake manifold.
(See Fig. 8-j)

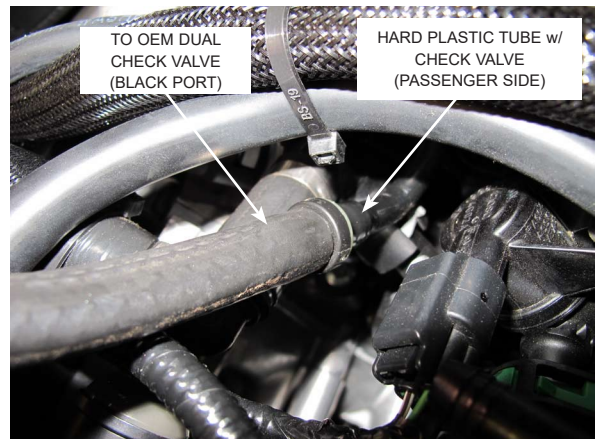

Fig. 8-j: 3/8" Hose - Hard Plastic Tube (Passenger Side)

- K. Attach the open end of the 3/8" hose to the black port on the dual check valve assembly.
(See Fig. 8-k)

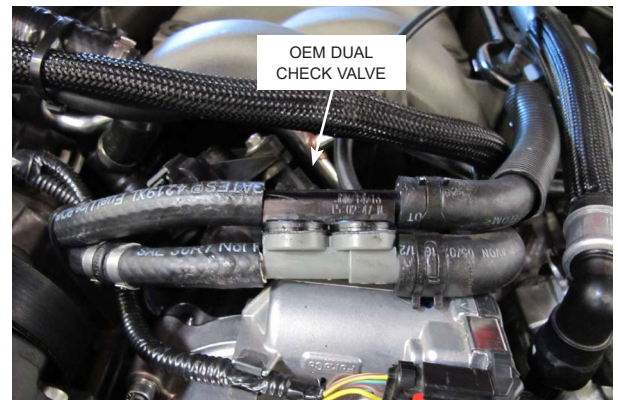

Fig. 8-k: 3/8" Hose Attachment

- L. Attach a length of 3/8" hose to the remaining leg of the 3/8" tee. Route the hose towards the front of the vehicle & attach the hose to the 3/8" barbed fitting on the supplied supercharger air inlet.
(See Fig. 8-l)

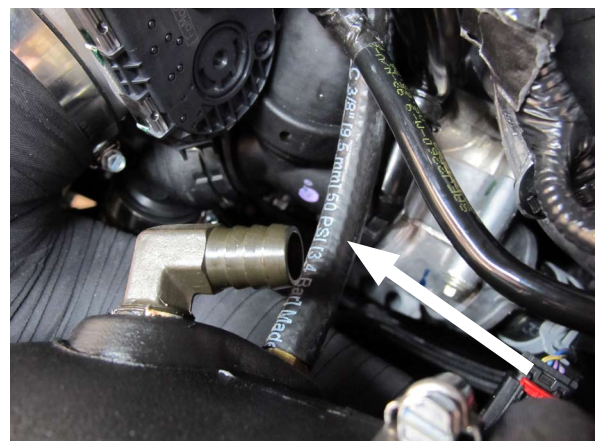
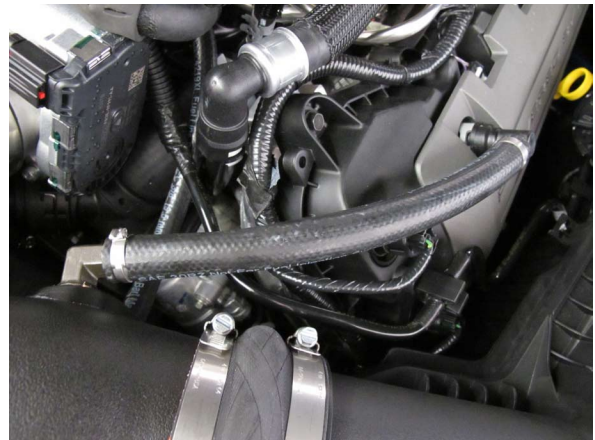

Fig. 8-l: 3/8" Hose From Tee To 3/8" Air Inlet Barb

8. AIR INLET ASSEMBLY INSTALLATION, cont'd

- M. Locate the provided 5/8" hose & cut an 11" length. Locate the OEM drivers side breather hose & remove the 90° quick release connector from the hose. Insert the quick release connector into the 5/8" hose, then attach the other end of the hose to the 5/8" barbed fitting on the supplied supercharger air inlet. Secure using 2x 25.6 steplessclamps. (See Fig. 8-m)



8-m: 5/8" Breather Hose

- N. Use the provided MAF port cover to block off the original location for the MAF sensor. Re-use the OEM hardware & the 2x supplied 6mm washers to secure the MAF port cover. Proceed to secure all hose clamps on the air inlet assembly at this time. (See Fig. 8-n)



Fig. 8-n: Air Inlet to Airbox Connection; MAF Port Cover

- O. Locate the 1" vacuum cap & slide it onto the bung of the diaphragm on the sound tube. Secure it using one of the provided zip ties. (See Fig. 8-o)



Fig. 8-o: 1" Vacuum Cap

8. AIR INLET ASSEMBLY INSTALLATION, cont'd

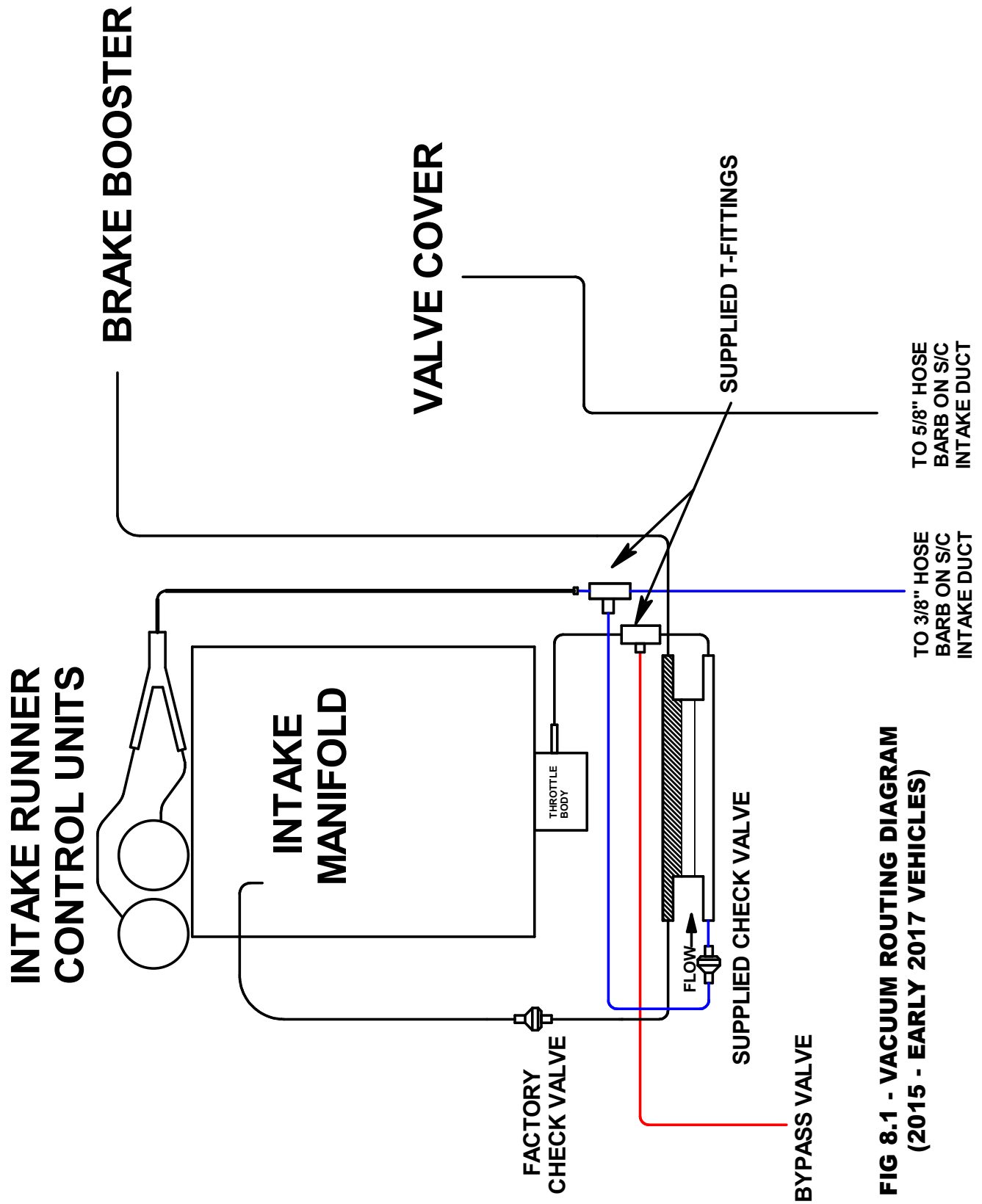

**FIG 8.1 - VACUUM ROUTING DIAGRAM
(2015 - EARLY 2017 VEHICLES)**

8. AIR INLET ASSEMBLY INSTALLATION, cont'd

NOTE: Vehicles equipped with vented Intake Manifold Runner Control solenoids as seen in Fig. 8-m proceed to Step P. All others proceed to Section 9.

- P. If your vehicle is equipped with individual breathers on the Intake Manifold Runner Control solenoids as seen in Fig. 8-m, you will need to reference the Vacuum Routing Diagram (Fig. 8.2) located on Pg. 46 for proper installation.
(See Fig. 8-p)



Fig. 8-p: Vented IMRC Solenoids

- Q. Remove the protective cover from the OEM dual check valve assembly. The following hoses will need to be removed from the dual check valve assembly:

a. Remove the hard plastic vacuum hose from the dual check valve assembly by slicing it the end with a razor blade. The other end of the hose is connected to a hard plastic tube with another check valve that runs beneath the passenger side of the intake manifold. Slice the hose at the check valve & remove it from the hard plastic tube.

b. Remove breather hose "A" from the dual check valve assembly. It will not be reused.

(See Fig. 8-q)

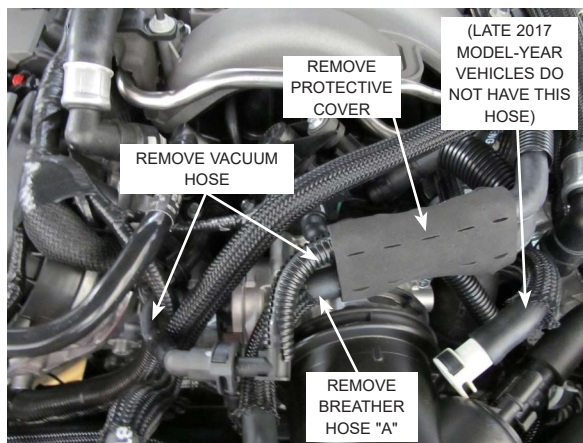

Fig. 8-q: Dual Check Valve Assembly

- R. With the hoses removed, you should be left with the ports on the left side of the dual check valve exposed.

(See Fig. 8-r)

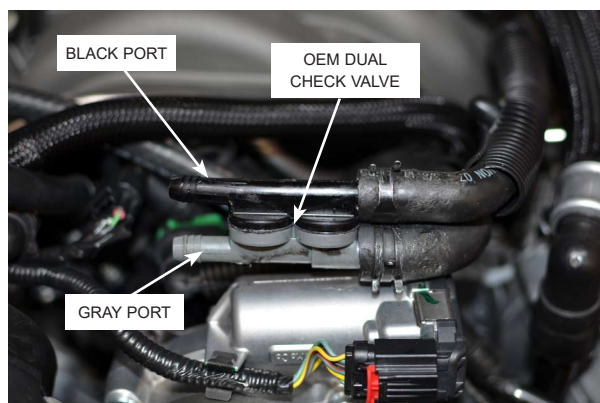

Fig. 8-r: Dual Check Valve Assembly
(Hoses Removed)

8. AIR INLET ASSEMBLY INSTALLATION, cont'd

- S. Attach a length of 3/8" hose to the hard plastic tube which runs underneath the passenger side of the intake manifold.

(See Fig. 8-s)

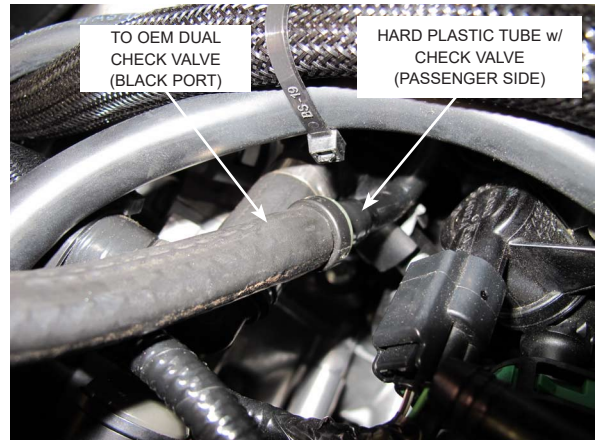

Fig. 8-s: 3/8" Hose - Hard Plastic Tube (Passenger Side)

- T. Attach the open end of the 3/8" hose to the black port on the dual check valve assembly. Next, attach a length of 3/8" hose to the remaining gray port then loop it around the throttle body & have it come out towards the front of the vehicle on the drivers side of the throttle body.

(See Fig. 8-t)



Fig. 8-t: 3/8" Hose Attachments

- U. Attach a length of 3/8" hose to the remaining leg of the 3/8" tee. Route the hose towards the front of the vehicle & attach the hose to the 3/8" barbed fitting on the supplied supercharger air inlet.

(See Fig. 8-u)

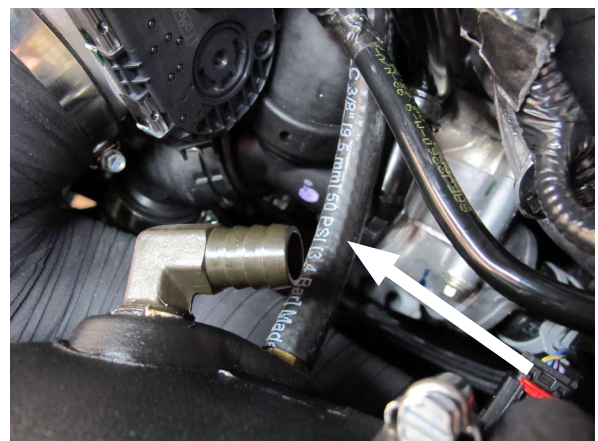
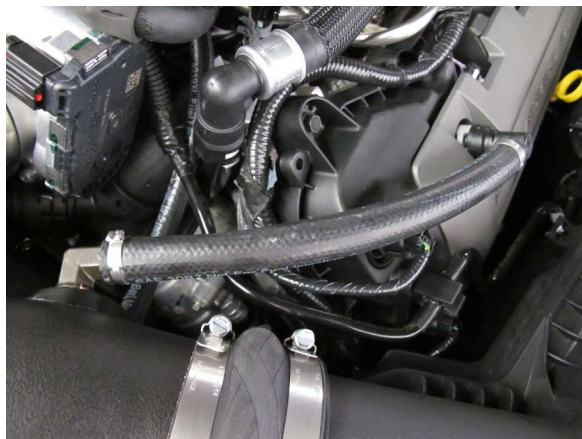

Fig. 8-u: 3/8" Hose From Dual Check Valve To 3/8" Air Inlet Barb

8. AIR INLET ASSEMBLY INSTALLATION, cont'd

- V. Locate the provided 5/8" hose & cut an 11" length. Locate the OEM drivers side breather hose & remove the 90° quick release connector from the hose. Insert the quick release connector into the 5/8" hose, then attach the other end of the hose to the 5/8" barbed fitting on the supplied supercharger air inlet. Secure using 2x 25.6 steplessclamps. (See Fig. 8-v)



8-v: 5/8" Breather Hose

- W. Use the provided MAF port cover to block off the original location for the MAF sensor. Re-use the OEM hardware & the 2x supplied 6mm washers to secure the MAF port cover. Proceed to secure all hose clamps on the air inlet assembly at this time. (See Fig. 8-w)



Fig. 8-w: Air Inlet to Airbox Connection; MAF Port Cover

- X. Locate the 1" vacuum cap & slide it onto the bung of the diaphragm on the sound tube. Secure it using one of the provided zip ties. (See Fig. 8-x)



Fig. 8-x: 1" Vacuum Cap

8. AIR INLET ASSEMBLY INSTALLATION, cont'd

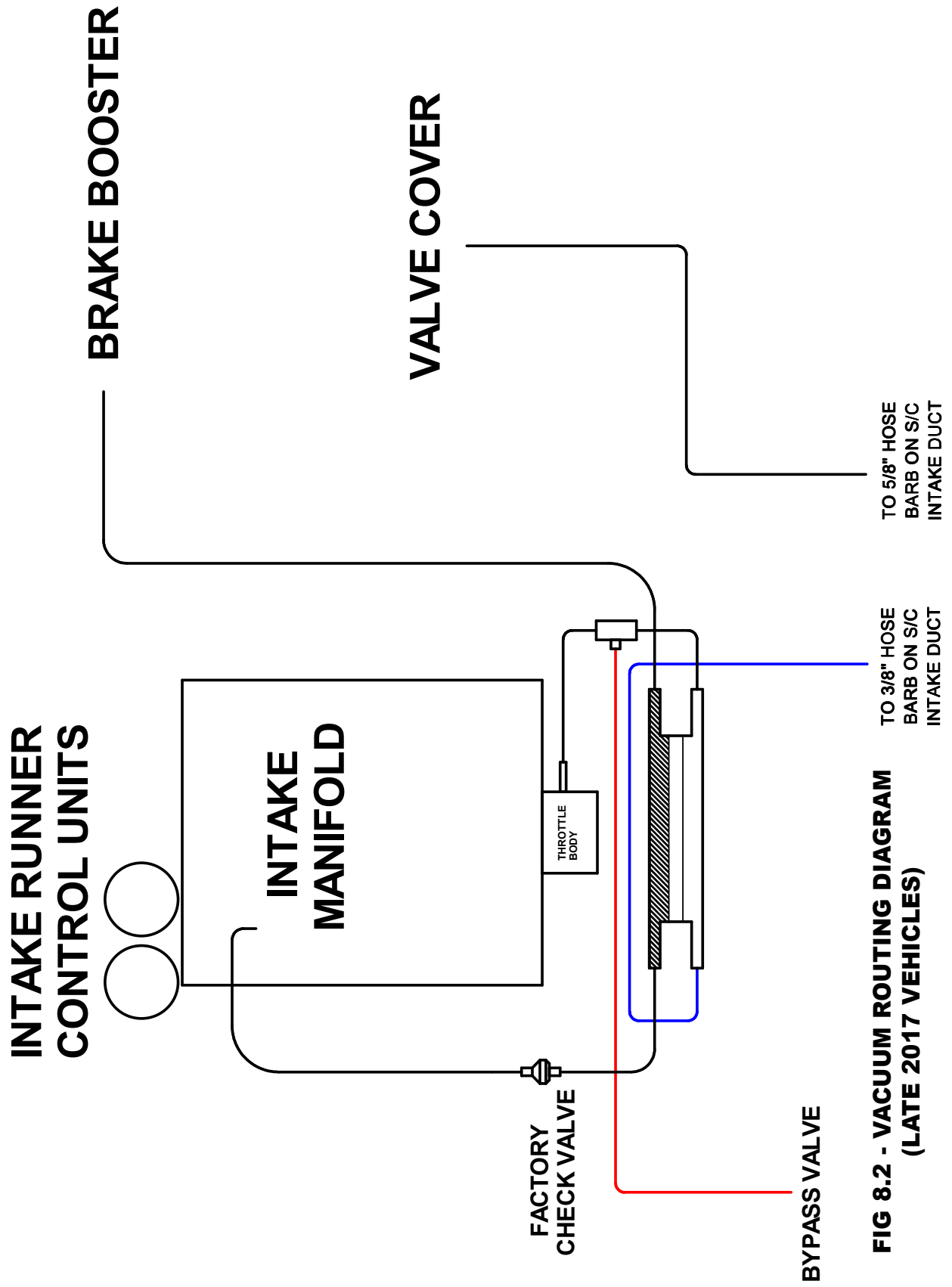

**FIG 8.2 - VACUUM ROUTING DIAGRAM
(LATE 2017 VEHICLES)**

9. BYPASS VALVE CONNECTION

- A. Locate the supplied vacuum tee fittings & assemble them as shown.

(See Fig. 9-a)



Fig. 9-a: Vacuum Tee Assembly

- B. Cut the OEM vacuum hose shown & insert the vacuum tee as shown.

(See Fig. 9-b)

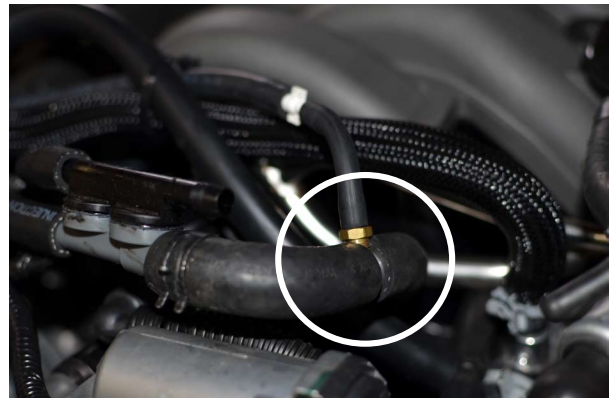

Fig. 9-b: Vacuum Tee Installation

- C. Attach the 7/32-5/32 reducer fitting & short length of 5/32 vacuum hose to the vacuum tee. Locate the supplied 7/32 vacuum hose & attach it to the reducer fitting. Run the vacuum hose along the top of the vehicle, across to the passenger side of the car. Route the vacuum hose down to the discharge tube with the bypass valve, making sure to avoid damaging the hose. Use the supplied zip ties to secure the vacuum hose.

(See Fig. 9-c)

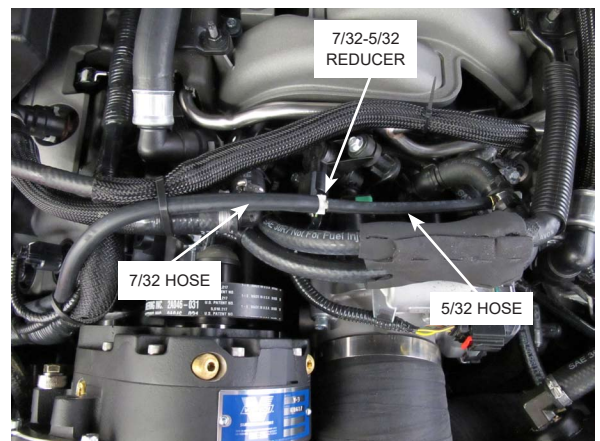

Fig. 9-c: Vacuum Hose Routing

9. BYPASS VALVE CONNECTION, cont'd

- D. Attach the open end of the 7/32 vacuum hose to the vacuum port on located on the top of the bypass valve.

(See Fig. 9-d)

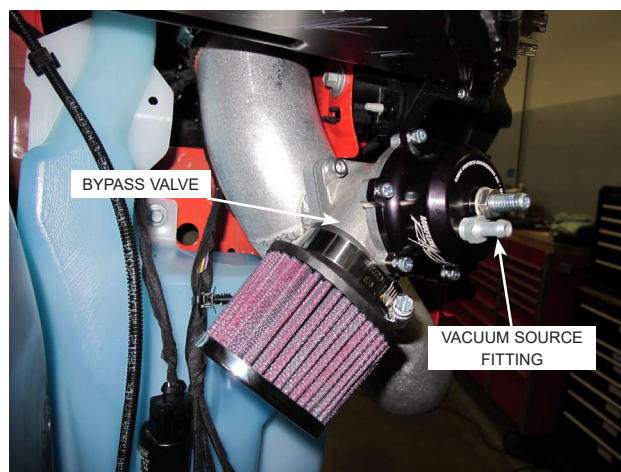

Fig. 9-d: Bypass Valve

10. MISCELLANEOUS REASSEMBLY

- A. Trim the passenger side front corner of the engine cover as shown. Start with a small cut and check fitment, only trimming away as much as necessary for clearance. (See Fig. 10-a)
- B. Reinstall all previously removed panels & bumper cover. Check for proper fitment & clearance during reinstallation.
- C. Plug the battery back in & secure the leads.



Fig. 10-a: Engine Cover Cut Detail

This page was left intentionally blank.

11. OIL FEED INSTALLATION (OIL-FED UNITS ONLY)

NOTE: There are 2x spacers included in the oil feed assembly. Discard those 2x spacers as they do not get used on these model-year vehicles.

- A. Locate the supercharger oil feed port on the passenger side of the supercharger.
(See Fig. 11-a)



Fig. 11-a: Supercharger Oil Feed Location

- B. Remove the blue plastic plug from the supercharger oil feed port and install the included -4AN male fitting.
(See Fig. 11-b)

NOTE: Use only clean engine oil on the pipe threads. Teflon tape or pipe sealant is not recommended as it might loosen and cause blockage of the small oil feed orifice resulting in possible supercharger failure.

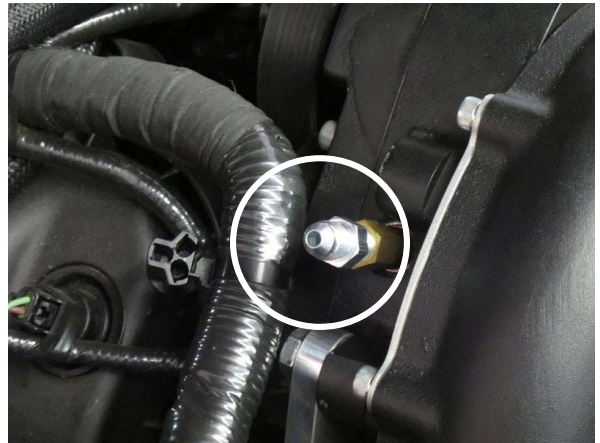

Fig. 11-b: -4AN Oil Feed Fitting Installed

- C. Connect the 90° end of the included -4AN braided oil feed hose to the supercharger oil feed fitting. Route the hose downward and toward the driver side between the supercharger discharge and the forward mounting plate. Continue routing the oil feed hose to the lower driver side area of the engine, passing it rearward between the alternator and the engine oil filter. Use extra care to secure the hose away from moving parts and sharp edges.
(See Fig. 11-c)

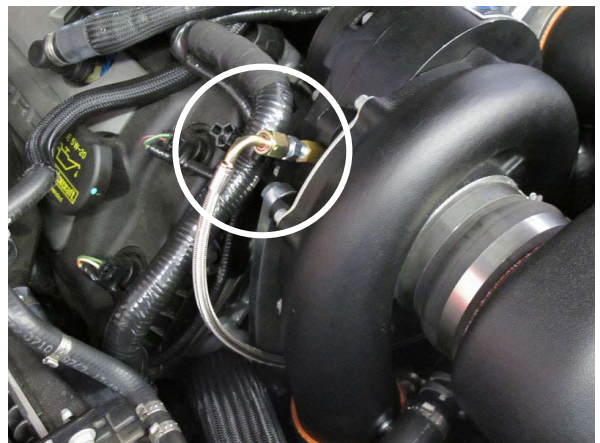

Fig. 11-c: 90° Oil Feed Hose Installed

11. OIL FEED INSTALLATION (OIL-FED UNITS ONLY), cont'd

- D. Locate the OEM oil pressure sensor located just above and behind the engine oil filter. Disconnect the electrical connector from the OEM oil pressure sensor and remove the sensor itself by unthreading it from its 1/4" NPT port. Temporarily plug the port, as a small amount of oil may drain out. (See Fig. 11-d)



Fig. 11-d: OEM Oil Pressure Sensor

- E. Install the supplied 1/4" NPT TEE fitting into the oil pressure sensor port and orient so one female port faces upward and one faces outward. Install the OEM oil pressure sensor into the upward-facing port of the TEE. Install the 1/4" NPT male x -4AN male 90° fitting into the outward-facing port of the TEE. Orient to point forward and slightly down. See Fig. 11-e for reference.

(See Fig. 11-e)

NOTE: Use only clean engine oil on the pipe threads. Teflon tape or pipe sealant is not recommended as it might loosen and cause blockage of the small oil feed orifice resulting in possible supercharger failure.



Fig. 11-e: Oil Feed Assembly
(shown removed for clarity)

- F. Reconnect the electrical connector to the OEM oil pressure sensor. Connect the straight end of the previously-installed -4AN braided hose to the -4AN male 90° fitting installed into the TEE, routing the hose between the alternator and oil filter. Confirm that all oil feed fittings are secure and that the hose is secured in a smooth path free of kinks and away from moving parts and sharp edges.

(See Fig. 11-f)



Fig. 11-f: Oil Feed Assembly Orientation

12. OIL DRAIN INSTALLATION (OIL-FED UNITS ONLY)

- A. In order to provide adequate room for the oil drain fitting, the 2x screws shown need to swap locations. Using a 10mm deep socket & a 13mm deep socket, swap both screw.

(See Fig. 12-a)

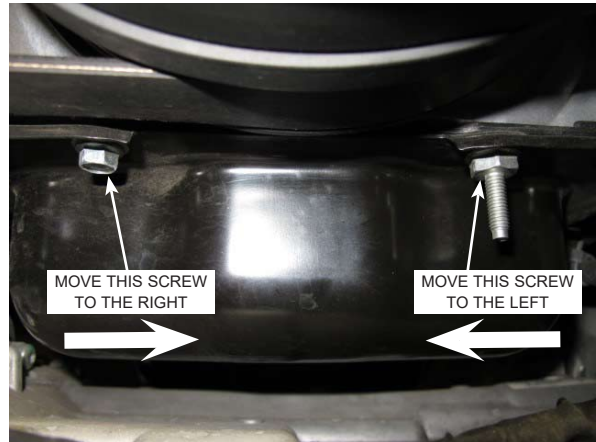

Fig. 12-a: Swap Screws

- B. Once the screws have been swapped around, remove paint from the smooth front face on the driver side of the oil pan where the hole will be made, then mark the location for the oil drain fitting, approximately 5/8" down from the oil pan mounting flange.

(See Fig. 12-b)



Fig. 12-b: Mark Oil Pan

- C. With the oil pan marked, use an 1/8" drill bit & drill a small pilot hole. Be sure to only drill enough to get through the oil pan & don't allow the full length of the drill bit to go through.

(See Fig. 12-c)

NOTE: To provide an oil drain for the supercharger, it is necessary to make a hole in the oil pan. It is best to drill a small pilot hole, then *punch* the hole to size rather than to drill it out. This method of rolling over the lip of the hole & tapping the oil pan works very well if carefully done and should cause no problems.



Fig. 12-c: Drill Pilot Hole

12. OIL DRAIN INSTALLATION (OIL-FED UNITS ONLY), cont'd

- D. Use a small center punch to expand the hole. Switch to a larger diameter punch and expand the hole further to approximately $\text{Ø}9/16"$, periodically checking that you don't damage anything behind the oil pan during this process. Most punches are made from hexagon material and may be placed in a socket with an extension to make this procedure easier. Tap the hole with a $3/8"$ NPT tap approximately $1/4"$ deep. Pack the flutes of the tap with heavy grease to hold chips. Use a small magnet to check for any stray chips. Clean the threaded area & apply a small amount of pipe sealant to the included $3/8"$ NPT hose barb fitting and install the fitting into the hole, making sure a seal is formed all around the fitting.

(See Fig. 12-d)

- E. Change the engine oil & filter to flush out any contaminants that may have entered the oil pan. Locate the oil drain hose previously attached to the barb fitting on the bottom of the supercharger. Trim the hose to length and secure it to the barbed oil drain fitting on the front of the oil pan with an included worm gear clamp, making sure to keep the hose routed away from any sharp or moving objects.

(See Fig. 12-e)



Fig. 12-d: Punch Hole In Oil Pan

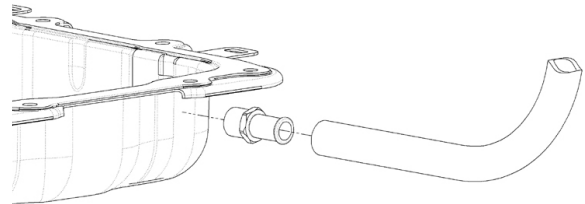

Fig. 12-e: Attach Oil Drain Hose To Oil Drain Fitting On Oil Pan

13. REFLASH COMPUTER

IMPORTANT! To ensure trouble-free programming of your vehicle's computer:

- Make sure the vehicle's battery is sufficiently charged.
- Turn off all accessories and close doors to prevent unnecessary drain on the battery.
- Do not attempt to program your vehicle while a battery charger is connected.
- Improper battery voltage will result in failure of the programming process.
- Do not disconnect the cable or turn off the ignition during programming unless prompted to do so.

- Reconnect the battery.
- With the vehicle off, locate the vehicle's OBD2 port located in the lower left hand corner of the dash on the driver side of the vehicle. (See Fig. 13-b) Make sure this connector is seated all the way into the vehicle's OBD2 port. Do not allow this connector to become disconnected during programming or damage may occur to the vehicle's ECM.
- The Reflash tool will power up and display "Program Vehicle". Press ENTER.
- In order to use the SCT Flash tool, you must agree to the terms set forth by SCT Flash. Press ENTER to agree.
- Follow the on-screen prompts to step through the reflash process.
 - When prompted to turn the key on, do so and wait for the vehicle to fully "boot up" When ready, press ENTER.
 - When prompted to "Select Vehicle" select "Mustang GT HO", then press ENTER.
 - The name of the tune being loaded will come up on the screen. Press ENTER.
 - The first phase of the reflash process will now begin.
 - After the process is done finalizing, you will be prompted to turn the key off. Once the key is off, the reflash tool will automatically proceed to the next step.
 - The reflash tool will now prompt you to turn the key on, but do not turn on the engine. Proceed to turn the key to the on position. The reflash tool will automatically proceed to unlock the processor and begin to set it up.
 - Now the reflash tool will begin to load the Vortech tune to your vehicle.
 - When the tune is loaded, the reflash tool will proceed to clear any DTC's.
- The reflash process is now complete. You may unplug the reflash tool from the OBD2 port at this time.



Fig. 13-b: OBD2 Connector and Port



Fig. 13-c: Flash Tool

NOTE: The red dot at the center of the D-Pad on the SCT Flash tool acts as the "ENTER" button.

This page was left intentionally blank.

14. FINAL CHECK

WARNING: Do not attempt to operate the vehicle until all components are installed and all operations are completed including the final check.

- A. If your vehicle has gone over 15,000 miles since its last spark plug change, you will need to change the spark plugs now *before* test driving the vehicle.
- B. Check all fittings, nuts, bolts and clamps for tightness. Pay particular attention to oil and fuel lines around moving parts, sharp edges, and exhaust system parts. Make sure all wires and lines are properly secured with clamps or tie-wraps.
- C. Check all fluid levels, making sure that your tank is filled with 91 octane or higher fuel before commencing test drive.
- D. Start the engine and allow to idle a few minutes, then shut off.
- E. Recheck to be sure that no hoses, wires, etc. are near exhaust headers or moving parts. Look also for any signs of fluid leakage.
- F. **PLEASE TAKE SPECIAL NOTE:** Operating the vehicle without ALL of the subassemblies completely and properly installed may cause **FAILURE OF MAJOR COMPONENTS.**
- G. Test drive the vehicle.
- H. Always listen carefully for engine detonation. Discontinue heavy throttle usage if detonation is heard.
- I. Read the **STREET SUPERCHARGER SYSTEM OWNER'S MANUAL AND RETURN THE WARRANTY REGISTRATION FORM** within thirty (30) days of purchasing your supercharger system to qualify.

For internally lubricated V3 units only

This supercharger has been factory pre-filled with special Vortech synthetic lubricant. Oil does not need to be added to a brand new unit, however a fluid level check should be performed.

Prior to operating the supercharger on the vehicle and after installation onto the vehicle:

Remove the factory installed flat-head brass shipping plug (not the dipstick) from the top of the supercharger case. Replace the sealed shipping plug with the supplied vented plug. Do not operate the supercharger without it. Check the supercharger fluid level using the dipstick as follows:

Fluid level checking procedure:

1. Ensure that the .06" copper sealing washer is located on the dipstick base.
2. Thread the clean dipstick into the unit until it seats.
3. Once the dipstick has seated, remove the dipstick from the unit. Fluid should register in the crosshatched area on the dipstick.
4. **DO NOT OVERFILL!!!** Drain excess fluid from the unit if it is above the maximum level on the dipstick.

Check the fluid level using the dipstick at least every 2,500 miles.

Initial supercharger fluid change must be performed at 2,500 miles. The supercharger fluid must be changed every 7,500 miles maximum thereafter.

Drain the fluid, refill the unit with 4 oz. of Vortech V3 lubricating fluid, and then confirm proper oil level using the dipstick. **DO NOT OVERFILL!!!**

WARNING: Use of any fluid other than the special Vortech lubricant will void the warranty and may cause component failure.



ENGINEERING, INC

1650 Pacific Avenue, Channel Islands, CA 93033-9901 • Phone (805) 247-0226
Fax: (805) 247-0669 • www.vortechsuperchargers.com • M-F 7:00 AM - 3:30 PM (PST)