

Dodge Charger 6.4L Supercharger System Installation Instructions

2015-2017 Model Year

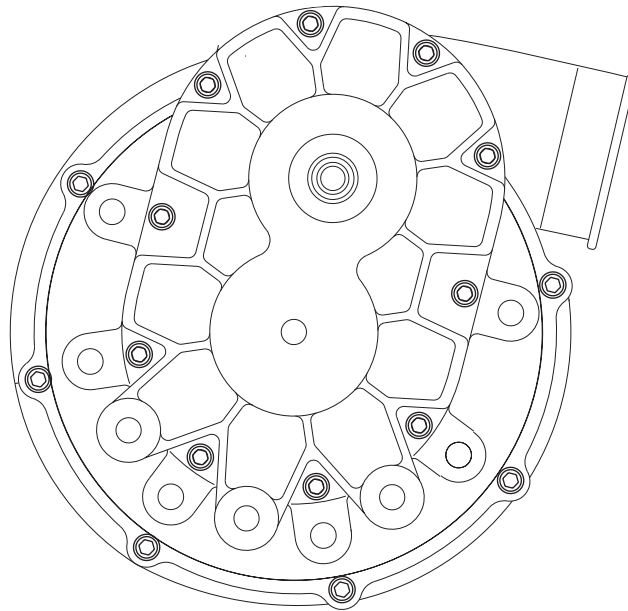

ENGINEERING, INC

1650 Pacific Avenue, Channel Islands, CA 93033-9901 • Phone (805) 247-0226
Fax: (805) 247-0669 • www.vortechsuperchargers.com • M-F 7:00 AM - 3:30 PM (PST)

FOREWORD

This manual provides information on the installation, maintenance and service of the Vortech supercharger kit expressly designed for this vehicle. All information, illustrations and specifications contained herein are based on the latest product information available at the time of this publication. Changes to the manual may be made at any time without notice. Contact Vortech Engineering for any additional information regarding this kit and any of these modifications at (805) 247-0226 7:00am-3:30pm PST.



Take note of the following before proceeding:

1. Proper installation of this supercharger kit requires general automotive mechanic knowledge and experience. Please browse through each step of this instruction manual prior to beginning the installation to determine if you should refer the job to a professional installer/technician. Please contact your dealer or Vortech Engineering for possible installers in your area.
2. This product was designed for use on stock (un-modified, OEM) vehicles. The PCM (computer), engine, transmission, drive axle ratios and tire O.D. must be stock. If the vehicle or engine has been modified in any way, check with Vortech prior to installation and use of this product.
3. Use only premium grade fuel with a minimum of 91 octane (*R+M/2*).
4. Always listen for any sign of detonation (*knocking/pinging*) and discontinue hard use (*no boost*) until problem is resolved.
5. Vortech is not responsible for any clutch, transmission, drive-line or engine damage.

Exclusions from Vortech warranty coverage considerations include, but not limited to:

1. Neglect, abuse, lack of maintenance, abnormal operation or improper installation.
2. Continued operation with an impaired vehicle or sub-system.
3. The combined use of Vortech components with other modifications such as, but not limited to, exhaust headers, aftermarket camshafts, nitrous oxide, third party PCM programming or other such changes.

©2019 VORTECH ENGINEERING, INC

All rights reserved. No part of this publication may be reproduced, transmitted, transcribed, or translated into another language in any form, by any means without written permission of Vortech Engineering, Inc.

TABLE OF CONTENTS

FOREWORD	<i>ii</i>
TABLE OF CONTENTS	<i>iii</i>
IMPORTANT NOTES	<i>iv</i>
TOOL & SUPPLY REQUIREMENTS	<i>v</i>
PARTS LIST	<i>vi</i>
1. ECU REMOVAL	1
2. BASIC COMPONENT REMOVAL	3
3. HARMONIC DAMPER DOWEL PIN INSTALLATION	11
4. FAN SHROUD & LOWER RADIATOR MOUNT MODIFICATION	15
5. ENGINE COOLING SYSTEM MODIFICATION	19
6. S/C MOUNTING BRACKET ASSEMBLY INSTALLATION	23
7. A/W COOLER, HEAT EXCHANGER, & DISCHARGE TUBE INSTALLATION	27
8. AIR INLET ASSEMBLY, BYPASS VALVE SIGNAL HOSE & S/C INSTALLATION	39
9. A/W COOLING SYSTEM INSTALLATION	43
10. MISC. REASSEMBLY	53
11. FINAL CHECK	55
APPENDIX A - DIAGRAM, ASSEMBLY, SUPERCHARGER MOUNTING BRACKET	56
APPENDIX B - DIAGRAM, BELT ROUTING	57

NOTICE

This product is protected by state common law, copyright and/or patent. All legal rights therein are reserved. The design, layout, dimensions, geometry, and engineering features shown in this product are the exclusive property of Vortech Engineering, Inc. This product may not be copied or duplicated in whole or part, abstractly or fundamentally, intentionally or fortuitously, nor shall any design, dimension, or other information be incorporated into any product or apparatus without prior written consent of Vortech Engineering, Inc.

2015-2017 Dodge Charger 6.4L Installation Instructions

Congratulations on selecting the best performing and best backed automotive supercharger available today... the VORTECH® supercharger!

Before beginning this installation, please read through this entire instruction booklet and the Street Supercharger System Owner's Manual which includes the Limited Warranty Program, the Warranty Registration form and return envelope.

Vortech supercharger systems are performance improving devices. In most cases, increases in torque of 30-35% and horsepower between 35-45% can be expected with the boost levels specified by Vortech Engineering. This product is intended for use on healthy, well maintained engines. Installation on a worn-out or damaged engine is not recommended and may result in failure of the engine as well as the supercharger. Vortech Engineering is not responsible for engine damage.

Installation on new vehicles will not harm or adversely affect the break-in period so long as factory break-in procedures are followed.

For best performance and continued durability, please take note of the following key points:

1. Use only premium grade fuel 91 octane or higher (R+M/2).
2. The engine must have stock compression ratio.
3. If the engine has been modified in any way, check with Vortech prior to using this product.
4. Always listen for any sign of detonation (pinging) and discontinue hard use (no boost) until problem is resolved.
5. **Oil Fed Units** - Perform an oil and filter change upon completion of this installation and prior to test driving your vehicle. Thereafter, always use a high grade SF rated engine oil or a high quality synthetic, and change the oil and filter at least every 3,000 miles. Never attempt to extend the oil change interval beyond 3,000 miles, regardless of oil manufacturer's claims as potential damage to the supercharger may result.
6. Before beginning installation, replace all spark plugs that are older than 1-year or 15,000 miles with original heat range plugs as specified by the manufacturer and reset timing to factory specifications (follow the procedures indicated within the factory repair manual and/or as indicated on the factory underhood emissions tag). Do not use platinum spark plugs unless they are original equipment. Change spark plugs every 15,000 miles.

TOOL & SUPPLY REQUIREMENTS

- 1/4" drive & 3/8" drive ratchet and drive set: SAE & metric
- 1/4" drive & 3/8" drive ratchet extensions
- Open end wrenches: SAE & metric
- Torque wrench
- Screwdriver set
- Hose cutters
- Drill motor & 1/4" drill bit
- Wire strippers & crimpers
- Utility knife
- Blue and red threadlocker
- Pipe sealant

If it has been 15,000 miles or more since your vehicle's last spark plug change, then you will also need:

- Spark plug socket
- NEW spark plugs

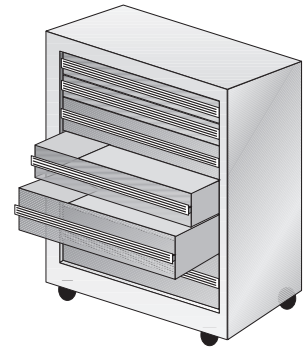



2015-2017 Dodge Charger 6.4L

Tuner Kit Part No. 4CM218-130L

PARTS LIST

IMPORTANT: Before beginning installation, verify that all parts are included in the kit. Report any shortages or damaged parts immediately.

PART NO.	DESCRIPTION	QTY.	PART NUMBER	DESCRIPTION	QTY.
008110	SMALL SILVER DIE CUT DECAL	2	7U041-000	1/2" HEATER HOSE	2.5FT
008130	LICENSE PLATE FRAME, VORTECH	1	7U100-055	TIE WRAP, 7.5" NYLON	10
008447	1 YR S/C STRT INFO PKG ASY VORT1		7U133-500	1/2 X 90 MOLDED RUBBER HOSE	1
009035	S/C LUBE, BOTTLED, 3-PACK	1	4CM212-030	DISCH ASY, 15-17 CHARG 6.4L	1
2A046-988	BELT, K060988, GATES	1	4CM012-030	DISCH SLEEVE C, 15-17 HEMI	1
2F329-170	V3 S/C ASY, 6.4L HEMI	1	4CM012-050	DISCH SLEEVE E, 15-17 HEMI 6.4L	1
4CL110-110	ASY, DAMPER PIN, HEMI	1	4CM012-070	DISCH SLEEVE B, 15-17 CHR	1
4GR010-110	GUIDE, DWL PIN IST, C5	1	4CM112-040	ASY, DISCH TUBE D, 15-17 HEMI	1
7C014-095	M14-1.5 X 95 MM SHCS, PLATED	1	4CM112-070	ASY, DISCH TUBE A, 15-17 CHR	1
7U250-019	DOWEL PIN, 1/4D X 1/2L	1	7A250-074	1/4-20 X .75 HHCS PLTD	2
7U250-026	DRILL BUSHING, 1/4ID., 375OD	1	7F250-021	1/4-20 NYLOCK NUT ZINC PLATED	2
4CM020-030	INSTR MAN, 15-17 CHARG 6.4L	1	7J250-001	1/4 WASHER, SAE, PLTD	4
4CM110-044	MNTG BRKT ASY, '15-'17 HEMI	1	7P375-250	3/8 X 3/8 X 1/4 MALE BARB TEE	1
2A017-016	PILOT, 6203/5 BRG, M10 3/8 SCREW	1	7PS300-275	REDUCER, BLK 3.0- 2.75	1
2A040-021	RETAINER, PULLEY, FLATHD	1	7R002-044	#44 SAE TYPE F SS HOSE CLAMP	2
2A040-051	PLY RETAINER, TAMPER PRF CAP	1	7R002-048	#48 SAE TYPE F SS HOSE CLAMP	5
2A040-061	RETAINER CUP, VORT S/C PLY	1	7R002-056	#56 SAE TYPE F SS HOSE CLAMP	1
2A042-080	BELT, GATES 20MM, 80T COG	1	7R004-007	STEPLESS CLAMP, 28.6	1
2D170-171	ASSY, JACKSHAFT, SHORT	1	7U030-218	7/32 VAC HOSE, BUNA-N	5
4CL116-350	IDLR ASSY, 3.5" DIA 20MM COG, SRT8	1	8H040-175	FILTER, 1.75" I.D., RACE BYPASS	1
4CM010-020	S/C MNTG PLT A, 15-17 HEMI CAR	1	5A002-071	MAP SENSOR, 3-BAR, SRT-4	1
4CM010-044	S/C MNTG PLT B, 15-17 HEMI CAR	1	8D204-064	ASY, MAXFLOW BYPASS VALVE	1
4CM010-050	PULLEY GUARD, 15-17 HEMI CAR	1	8N006-026	HEAT EXCHANGER, CAC SYS	1
4CM036-360	S/C PULLEY 3.60" 6 GROOVE	1	8N107-200	ASY, W/P MNTG, 15-17 HEMI CAR	1
4CM100-001	HARDWARE ASSY, S/C MNTG BRKT	1	5W001-141	HARNES, AUX W/P, 15-17 HEMI CAR	1
4CM100-002	SPACER ASSY, S/C MNTG BRKT	1	7A250-075	1/4-20 X .75 SHCS PLTD	1
4FH016-150	IDLER PLY, SMOOTH 6RIB 3" FLANGD	1	7F250-021	1/4-20 NYLOCK NUT ZINC PLATED	1
4GR032-032	PLY, JACKSHAFT, C5, 20MM, 32T	1	7R003-029	ADEL CLAMP, 1-5/8" ID	1
4CM112-030	AIR INLET ASSY, 15-17 HEMI CAR	1	8F001-405	BOSCH AUX WATER PUMP	1
7P500-009	1/2" X 90 HOSE BARB UNION	1	8N201-400	ASY, CAC, SAT, 15-17 HEMI CAR	1
7P750-502	REDUCER, 3/4" TO 1/2" COUPLER	1			
7U030-036	1/2" OIL DRAIN HOSE	2.5FT			
8H040-240	AIR FILTER, 15-17 HEMI CAR	1			
4CM155-030	SUPPRT ITEMS, CAC SYS, '16 HEMI	1			
4CM011-012	BRKT, HEAT EXCHANGER, P. SIDE	1			
4CM011-013	BRKT, HEAT EXCHANGER, D. SIDE	1			
4CM011-014	BRKT, CAC RESERVOIR, 15-17 HEMI	1			
4CM011-015	BRKT, CAC, D. SIDE, 15-17 HEMI	1			
4CM011-018	HORN BRKT, 15-17 HEMI CAR	1			
4CM011-019	BRKT, CAC, P. SIDE, 15-17 CHR	1			
4CM011-020	BRKT, CAC, TOP SIDE, 15-17 CHR	1			
4CM055-020	RESERVOIR, CAC, '16 CHALL	1			
5W001-082	SLEEVE, FLEX BRAID .75" NOM.	6FT			
7A250-050	1/4-20 X .50 SHCS GR8 ZINC PLTD	8			
7A250-051	1/4-20 X .50 HHCS GR5 ZINC PLTD	1			
7A250-075	1/4-20 X .75 SHCS PLTD	2			
7A250-500	1/4-20 X 5 SHCS	4			
7C060-011	M6 X 1.0 X 10 HXHD CL8.8 PLT	1			
7C080-012	M8 X 1.25 X 12MM LOW SHCS	1			
7F006-093	NUT, M6 X 1.0, NYLOCK, PLATED	2			
7F250-021	1/4-20 NYLOCK NUT ZINC PLATED	4			
7J250-001	1/4 WASHER, SAE, PLTD	8			
7J312-000	5/16 FLAT WASHER-SAE	1			
7P375-075	3/4" HOSE BARB UNION, BRASS	1			
7P500-035	FITTING, 1/2 NPT X 3/4 BARB X 45	1			
7P500-078	1/2NPT X 3/4 HOSE FIT STRT	1			
7P750-502	REDUCER, 3/4" TO 1/2" COUPLER	1			
7P750-503	3/4-1/2 REDUCER BARB 90	1			
7R001-006	#6 STNLS HOSE CLAMP, NARROW	4			
7R002-010	#10 SAE TYPE F SS HOSE CLAMP	8			
7R004-007	STEPLESS CLAMP, 28.6	2			
7T100-281	9/32" X 6" OAL EXTENDED DRILL	1			
7U030-065	HOSE, 3/4 X 90 ELBOW, SHORT	1			
7U038-000	3/4" HEATER HOSE	1.5FT			
7U038-000	3/4" HEATER HOSE	4FT			
7U038-012	HOSE, 3/4 DIA 90, 4 X 12 LEGS	1			
7U038-150	HOSE, 3/4 D X 150 MOLDED HOSE	2			

1. ECU REMOVAL



If you purchased a 'Tuner' supercharger system, it will be up to you to have the ECU unlocked.

- A. Open the trunk and lift the carpet. Remove the positive battery terminal cover from the battery, then proceed to unplug both battery leads.

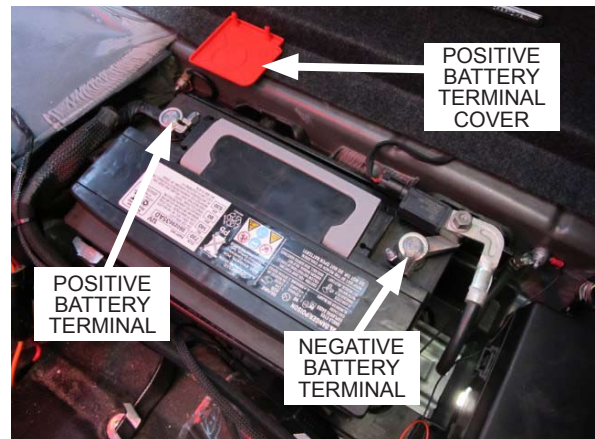

Fig. 1-a: Unplug battery

- B. There are nine plastic fasteners that secure the windshield cowl to the cross bar. Using a panel removal tool, remove the nine plastic fasteners and set them aside.



Fig. 1-b: Remove plastic fasteners

- C. You will notice that the windshield cowl is secured to the top of the passenger side fender. Detach the windshield cowl by pulling it away from the fender. Be sure not to damage the fender or windshield during this step.



Fig. 1-c: Detach windshield cowl from passenger side fender

1. ECU REMOVAL

- D. With the windshield cowl detached from the passenger side fender, pull up on the passenger side of the windshield cowl to allow access to the ECU.



Fig. 1-d: Lift up passenger side of windshield cowl

- E. There are two nuts securing the ECU to its mounting bracket. Using a 10mm wrench, remove the ECU nuts and set them aside. You will notice that the ECU mounting bracket is attached to the cross bar. Using a 13mm socket, remove the ECU mounting bracket screw, then proceed to remove the ECU mounting bracket and set it aside, but leave the ECU in the vehicle.

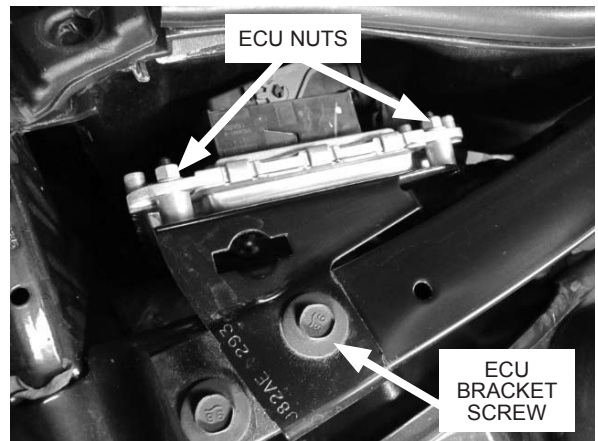

Fig. 1-e: Remove ECU nuts and remove cross bar screws

- F. Now that ECU mounting bracket is removed, proceed to disconnect the ECU connectors. You will need to disconnect each connector one at a time as it makes it easier to remove the ECU.

NOTE: In order to be able to tune the vehicle, the ECU will need to be removed and sent out to be unlocked. Refer to **Appendix C** near the back of this manual for ECU mailing instructions.



Fig. 1-f: Disconnect ECU

2. BASIC COMPONENT REMOVAL

- A. Using a panel removal tool, remove the twelve plastic fasteners securing the top of the front bumper cover and set them aside. Remove the small 'CHARGER' panel located near the hood latch and set it aside.

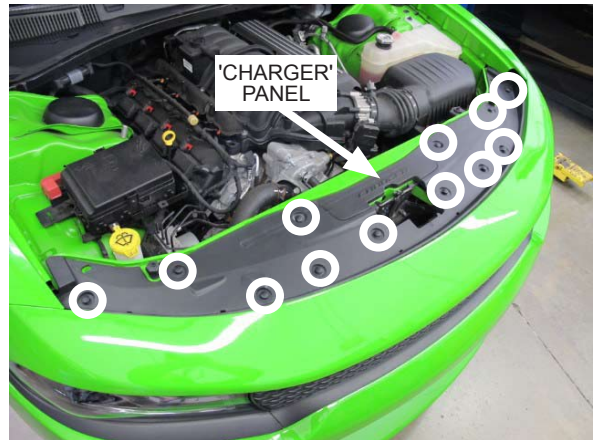

Fig. 2-a: Remove upper front bumper fasteners

- B. Using a panel removal tool, remove the four plastic fasteners securing the brake cooling duct to the fender liner. Next, remove the three plastic fasteners securing the engine service panel to the fender liner. Do this for both sides of the vehicle.

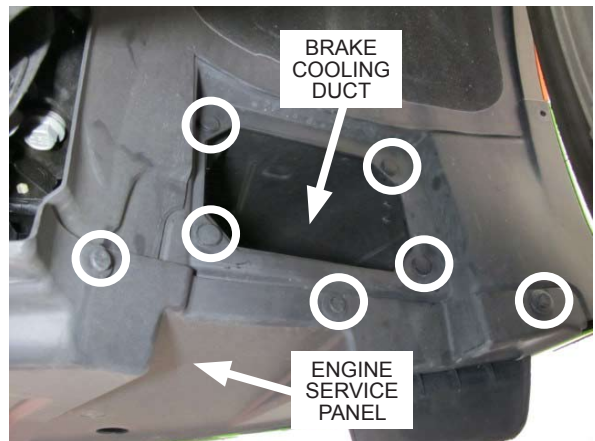

Fig. 2-b: Remove brake cooling duct and engine service panel fasteners

- C. In order to remove the front bumper cover, the fender liners will need to be moved out of the way. Using a panel removal tool, remove the nine plastic fasteners securing the front half of the fender liner to the vehicle. Once all nine plastic fasteners have been removed, pull the fender liner away from the front bumper cover and fenders. The fender liner does not need to be completely removed from the vehicle, just pushed off to the side. Repeat this step for both sides of the vehicle.

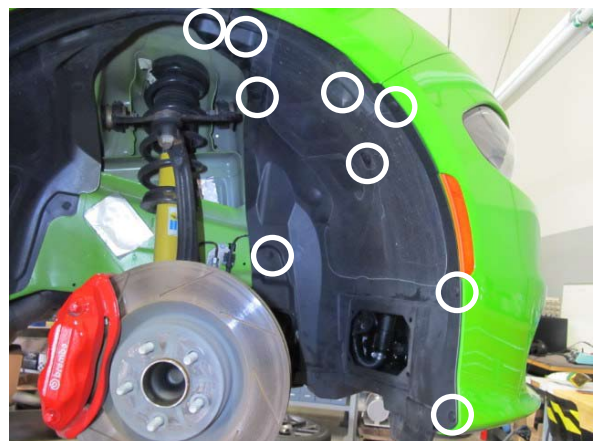

Fig. 2-c: Remove fender liner fasteners

2. BASIC COMPONENT REMOVAL

- D. Using a panel removal, remove the three plastic fasteners securing the front bumper cover to the vehicle and set aside. Next, using a 10mm socket, remove the four screws securing the engine service panel to the vehicle and set aside.



Fig. 2-d: Remove engine service panel fasteners

- E. Located behind each side of the front bumper cover are the fog light connectors. You will notice that both fog light connectors are mounted to the brake cooling ducts. Using a panel removal tool, remove the fog light connectors from the brake cooling ducts. Next, disengage the red locking tab and disconnect the fog lights. Do this for each fog light.



Fig. 2-e: Disconnect fog lights

- F. Located behind each corner of the front bumper cover are orange corner lights. Reaching from behind the front bumper cover, disconnect each corner light.

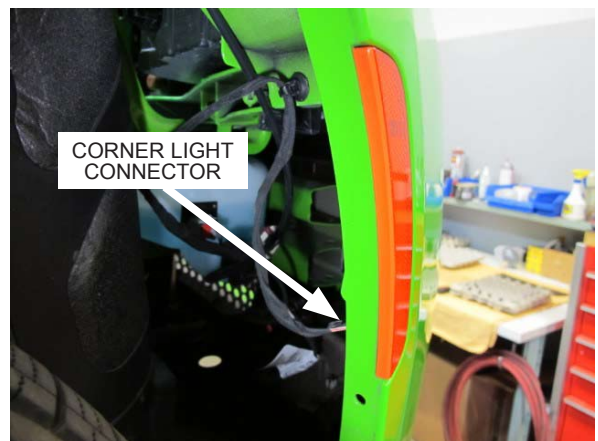

Fig. 2-f: Disconnect corner lights

2. BASIC COMPONENT REMOVAL

- G. Located on each of the top corners of the front bumper cover is a screw securing the front bumper cover to the fender. Using a 10mm socket, remove these screws and set aside.



Fig. 2-g: Remove each upper front bumper cover screw

- H. On each side of the front bumper cover are two additional screws that secure the front bumper cover to the fenders. To gain access to these screws we suggest pulling back the fender liner, then using a 1/4" drive ratchet and 10mm socket to remove the screws. Once screws are removed, proceed to remove front bumper cover.

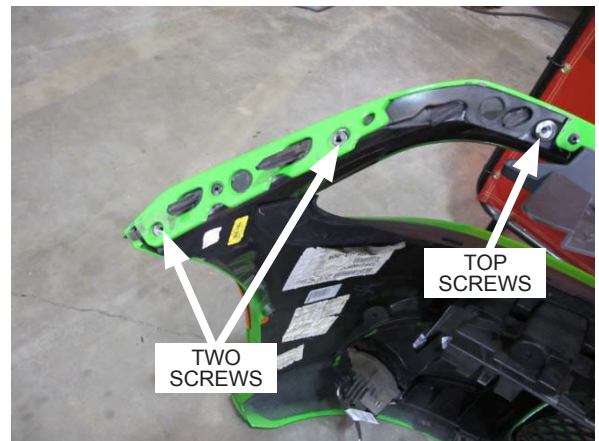

Fig. 2-h: Remove screws
(Bumper removed for clarity)

- I. **Vehicles with adaptive cruise control:** Disconnect the adaptive cruise control sensor connector and detach the harness from the side of the sensor.



Fig. 2-i: Disconnect adaptive cruise control sensor

2. BASIC COMPONENT REMOVAL

- J. **Vehicles with adaptive cruise control:** The adaptive cruise control harness runs along the top of the front bumper support. Using a panel removal tool, detach the harness from the front bumper support. Located behind the front bumper support is the ambient air temperature sensor. Using a panel removal tool, detach the ambient air temperature sensor from the rear of the front bumper support.

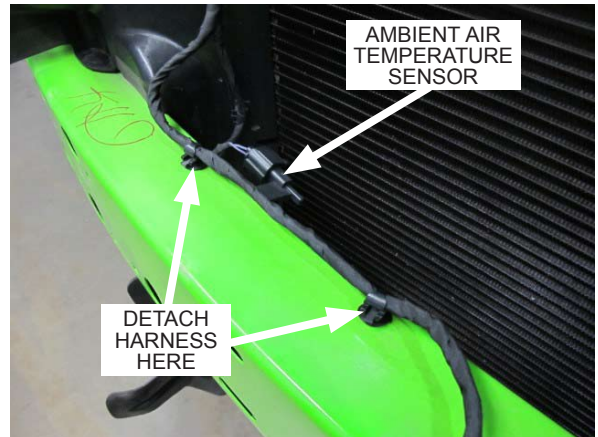

Fig. 2-j: Detach adaptive cruise control harness

- K. Using a panel removal tool, remove the fasteners securing both of the radiator shrouds, then remove the radiator shrouds from the vehicle. They will not be reused.

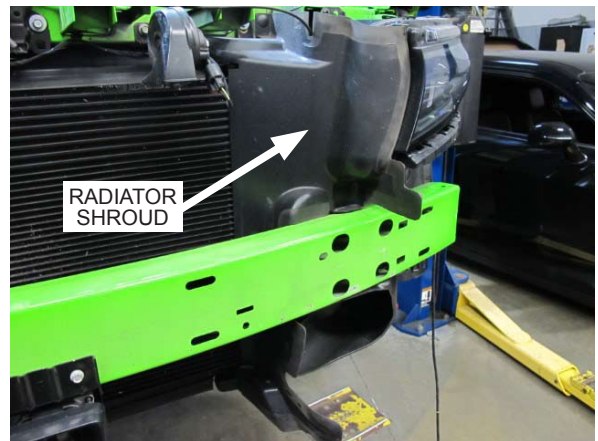

Fig. 2-k: Remove both radiator shrouds (Driver side shown)

- L. Using a 10mm socket and a panel removal tool, remove the plastic fasteners and screws securing the brake cooling ducts to the vehicle, then remove both brake cooling ducts from the vehicle. They will not be reused. You will also see a plastic panel attached to the driver side frame rail. Using a panel removal tool, remove the fasteners securing the panel, then remove the panel from the vehicle. It will not be reused.

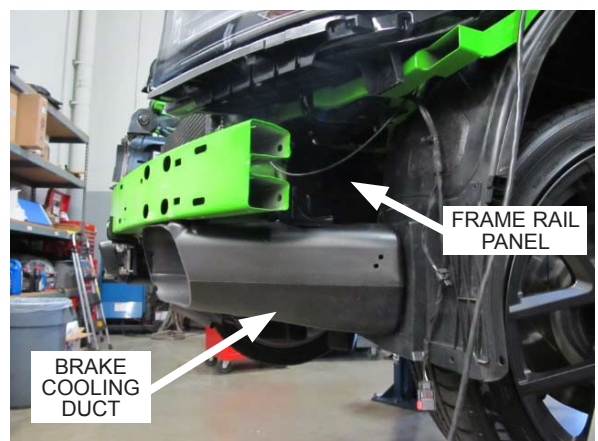

Fig. 2-l: Remove both brake cooling ducts (Driver side shown)

2. BASIC COMPONENT REMOVAL

- M. Using a 10mm socket, remove the screw securing the airbox to the vehicle. Detach the breather hose from the airbox, disconnect the IAT sensor and loosen the hose clamp securing the air inlet duct to the throttle body. Remove the airbox and air inlet duct from the vehicle as they will not be reused. Set the breather hose aside as it will be reused in a later step.

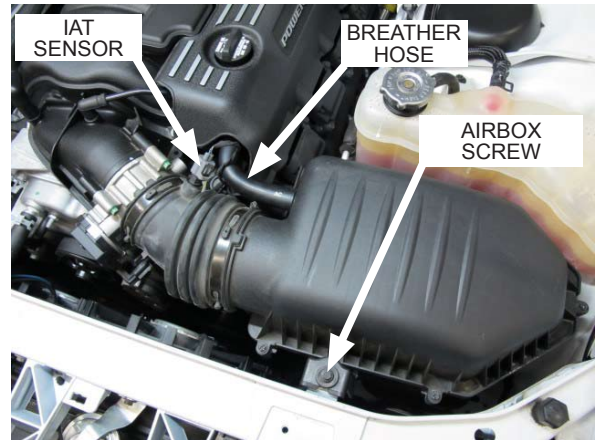

Fig. 2-m: Remove airbox and air inlet duct

- N. In order to make more working space when pinning the crankshaft in a later step, it will be necessary to remove the radiator fan assembly. There is one screw on each side of the radiator fan assembly. Using a 10mm socket, remove the screws and set aside.



Fig. 2-n: Remove radiator fan assembly

- O. Locate the coolant drain valve on the bottom of the radiator on the passenger side. Open the drain valve and drain the engine coolant into a clean container. The engine coolant will drain from the factory-installed engine coolant drain hose.

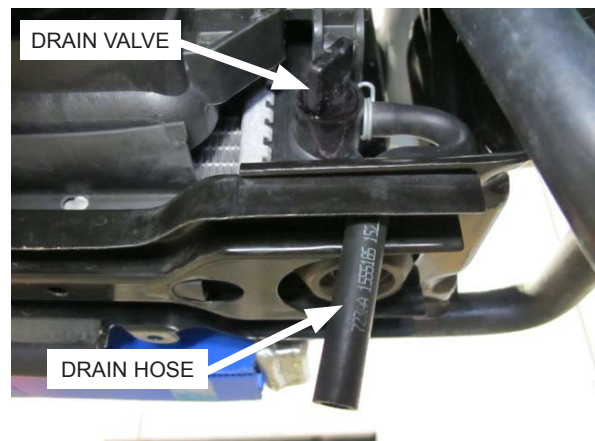

Fig. 2-o: Drain coolant

2. BASIC COMPONENT REMOVAL

- P. There is a small coolant hose that is attached to the radiator fan assembly. Detach this hose from the radiator fan assembly, then proceed to unplug the radiator fan connector.



Fig. 2-p: Detach coolant hose and unplug radiator fan connector

- Q. Detach the lower radiator hose from the driver side of the radiator. The opposite end of the lower radiator hose will remain attached to the engine.

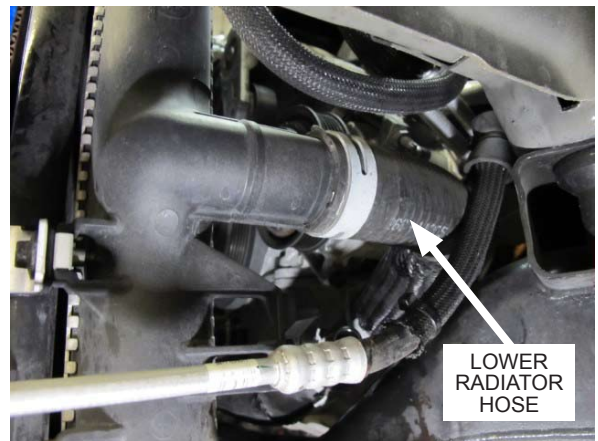

Fig. 2-q: Detach lower radiator hose

- R. The radiator rests on the lower radiator support. Since the lower radiator support will be removed in the next step, it will be necessary to secure the radiator to the vehicle. Using zip ties, pass them through the holes on the upper part of the radiator, near the upper radiator alignment brackets, and wrap the zip tie around the core support. Repeat this step for both sides of the radiator.

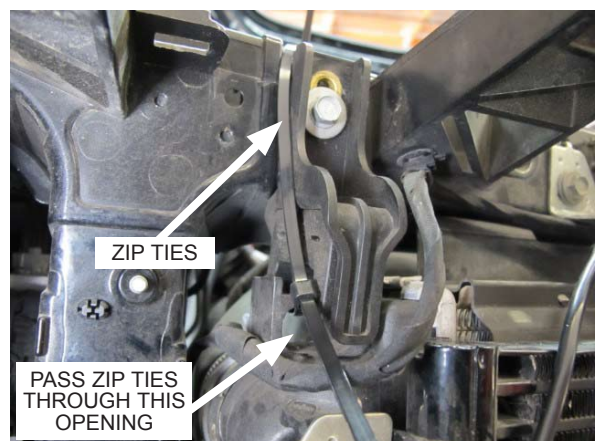

Fig. 2-r: Zip tie radiator to core support

2. BASIC COMPONENT REMOVAL

- S. The A/C condenser and radiator fan assembly are attached to the radiator, which is mounted to the lower radiator support. In order to remove the radiator fan assembly from the vehicle, the lower radiator support will need to be removed from the vehicle. Doing this will allow the radiator, A/C condenser, and radiator fan assembly to be lowered and moved forward, away from the engine. Place a floor jack (or a suitable tool) underneath the lower radiator support, then use a 13mm socket and proceed to remove the four screws (two per side) from each side of the lower radiator support. Be sure to remember which side of the lower radiator support is the driver side.

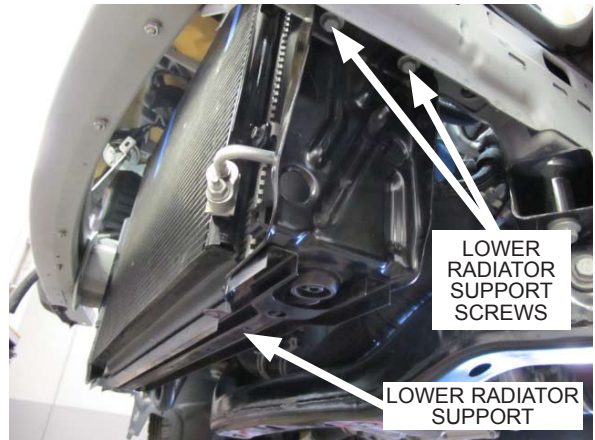

Fig. 2-s: Remove lower radiator support hardware

- T. Now that the lower radiator support is no longer fastened to the vehicle, proceed to lower the lower radiator support away from the vehicle. Once you have enough room, remove the radiator fan assembly from the radiator and set it aside.

NOTE: The A/C lines will remain attached to the A/C condenser. Be sure to avoid damaging the A/C lines during this process.

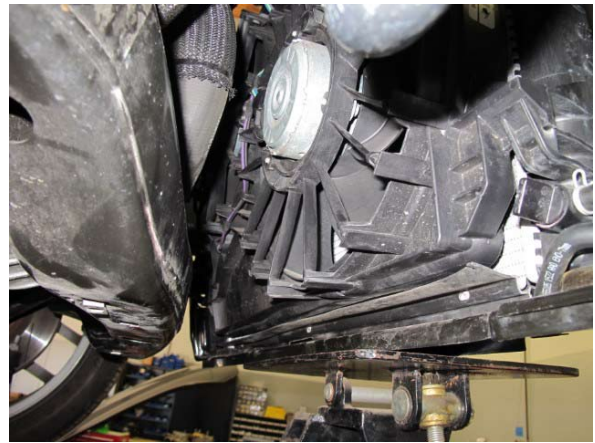

Fig. 2-t: Remove radiator fan assembly

- U. Use a long 3/8" ratchet or 3/8" breaker bar to rotate the belt tensioner clockwise to release tension from the 6-rib accessory drive belt. Remove the belt as it will not be reused.

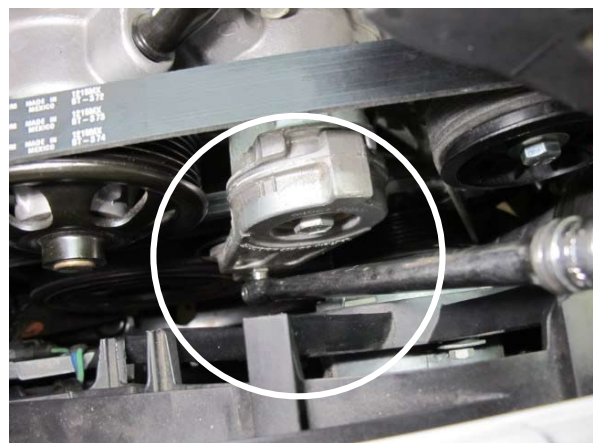

Fig. 2-u: Remove accessory drive belt

2. BASIC COMPONENT REMOVAL

- V. Located on the driver side cylinder head is an idler pulley mount assembly. Using a 13mm socket, remove the three screws securing the assembly to the driver side cylinder head. The assembly and hardware will not be reused.

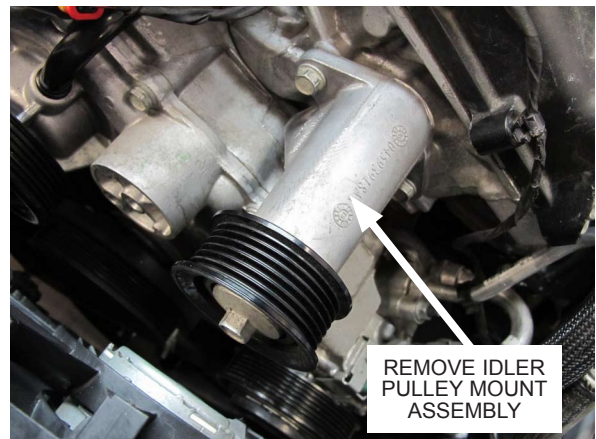

Fig. 2-v: Remove idler pulley mount assembly

3. HARMONIC DAMPER DOWEL PIN INSTALLATION

NOTE: Be sure to avoid damaging the radiator during this section. We suggest temporarily covering the radiator with a piece of cardboard.

- A. Remove the factory crankshaft damper bolt. To lock the engine in place, use a flywheel / flexplate locking tool or a large pry bar to keep the engine from rotating. See Fig. 3-f & Fig. 3-g.



Fig. 3-a: Remove crankshaft damper bolt

- B. Install the supplied drill guide, making sure that the raised section is used as a pilot inside the damper bore. Secure it in place using the supplied socket head cap screw. Do not overtighten the screw as it may distort the drill guide.



Fig. 3-b: Install drill guide

- C. Using a piece of tape or a drill stop, mark your 1/4" drill bit at a point of 2.60" from the tip of the drill bit.

NOTE: Be sure to use a sharp, high quality 1/4" drill bit for this step.

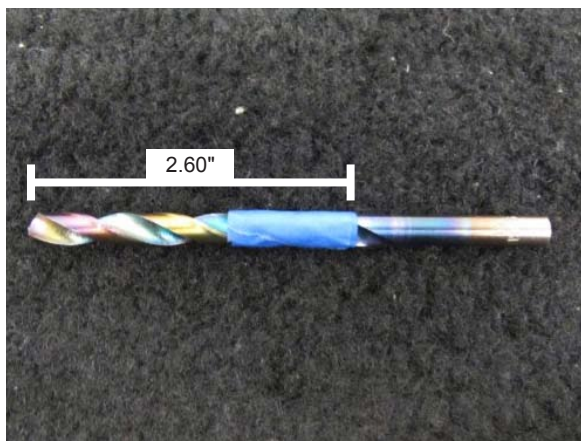

Fig. 3-c: Measure drill bit to 2.60"

3. HARMONIC DAMPER DOWEL PIN INSTALLATION

- D. Using an angle drill or a small drill motor, drill into the crankshaft / damper assembly through the bushing in the drill guide, making sure to keep the tool perpendicular to the damper. Stop when the mark on the drill bit is even with the face of the damper. This will yield a hole depth of 1/2".

NOTE: Periodically stop and allow the drill bit to cool down. Overheating the drill bit may cause it to dull and potentially break. We suggest using cutting oil to ease this step.



Fig. 3-d: Drill crankshaft / damper assembly

- E. Remove the drill guide, then proceed to clean the area/hole of metal chips. Install the supplied dowel pin in the drilled hole, making sure that it doesn't protrude past the damper face.

NOTE: The hole depth should be more than enough to allow the dowel pin to fully seat, however if the dowel pin still protrudes past the damper face, use a small grinding disk to grind down the dowel pin so it is parallel with the face of the damper face.



Fig. 3-e: Install dowel pin

- F. Remove the flywheel access panel by removing the screw using a 10mm socket, then pulling the panel away from the transmission.

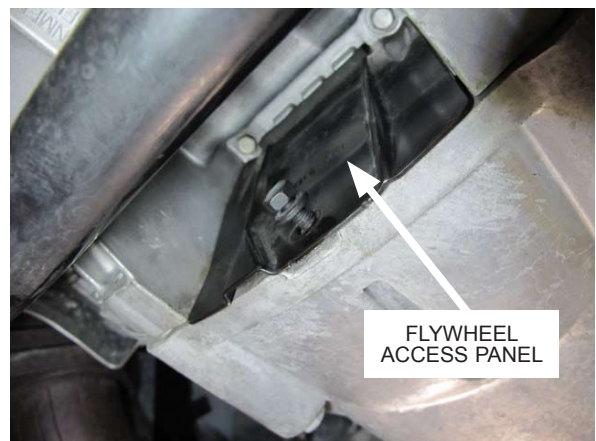

Fig. 3-f: Remove transmission access panel

3. HARMONIC DAMPER DOWEL PIN INSTALLATION

- G. Using a flywheel / flexplate locking tool or a large pry bar, lock the engine in position to keep it from rotating while you torque the crankshaft damper bolt.



Fig. 3-g: Lock engine in position



Use red threadlocker on the crankshaft damper bolt.

- H. With the flywheel / flexplate locked in place, install and tighten the crankshaft damper bolt to 143ft-lbs.



Fig. 3-h: Torque crank bolt

This page was left intentionally blank.

4. FAN SHROUD & LOWER RADIATOR MOUNT MODIFICATION

- A. In order to provide enough space for a discharge sleeve that will be installed in a later step, some of the outer edges on the upper section of the driver side fan will need to be rounded over and brought down as shown.



Fig. 4-a: Modified outer edge example

- B. Remove one of the ribs, then modify the four outer edges shown.

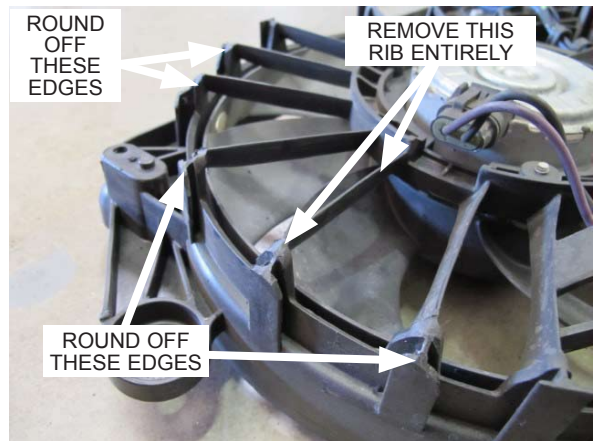

Fig. 4-b: Modify as shown

- C. Reinstall the radiator fan assembly and verify that the electrical connector is plugged in. Secure using the OEM hardware.



Fig. 4-c: Reinstall radiator fan assembly

4. FAN SHROUD & LOWER RADIATOR MOUNT MODIFICATION

- D. Reattach the lower radiator hose to the radiator and secure using the OEM spring clamp.

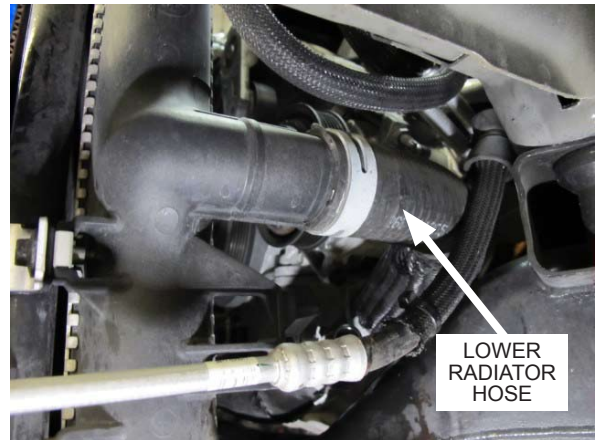

Fig. 4-d: Reattach lower radiator hose

- E. Locate the lower radiator support. The driver and passenger side rear edge will need to be modified. Be sure to remember which side of the lower radiator support is the driver side.



Fig. 4-e: Lower radiator support

- F. Two holes will need to be drilled on the driver side rear edge of the lower radiator mount. From the bottom edge of the lower radiator support, make a line at 3.25".



Fig. 4-f: Measure 3.25" from bottom edge

4. FAN SHROUD & LOWER RADIATOR MOUNT MODIFICATION

- G. Measuring from the inside edge of the lower radiator support, measure 1/2" and make a line. This will be the location of the first hole.

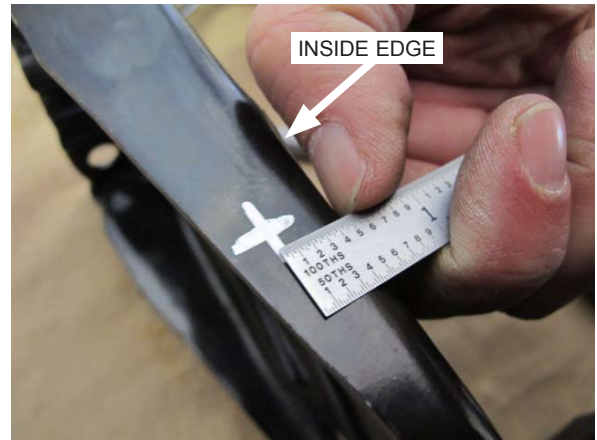

Fig. 4-g: Measure 1/2" from inside edge

- H. Measuring from the first marks, make another line up at 2.00". Lastly, measuring from the inside edge, measure 1/2" and make another line. This will be the location of the second hole.

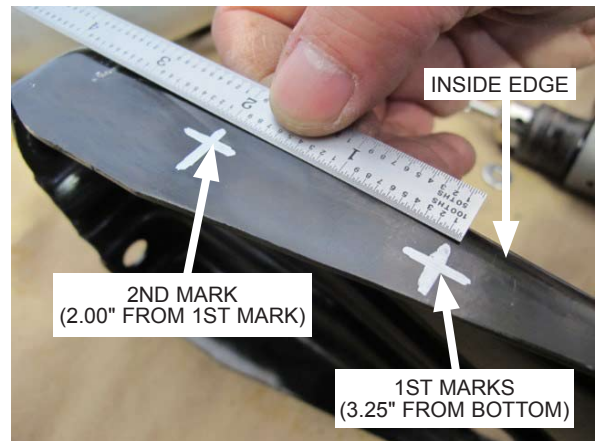

Fig. 4-h: Measure 2.00" up from first marks

- I. With both hole locations marked on the driver side rear edge of the lower radiator mount, use a 9/32" drill bit to drill through the center of both measurements.



Fig. 4-i: Drill holes on driver side rear edge of lower radiator support

4. FAN SHROUD & LOWER RADIATOR MOUNT MODIFICATION

- J. A hole will need to be drilled on the passenger side rear edge of the lower radiator mount. Using the measurements in Fig. 4-j, mark the center of the measurements and use a 9/32" drill bit to drill through the passenger side rear edge of the lower radiator mount.



Fig. 4-j: Drill hole on passenger side rear edge of lower radiator support

- K. After the three holes are drilled and deburred, proceed to reinstall the lower radiator support and secure using the OEM hardware.

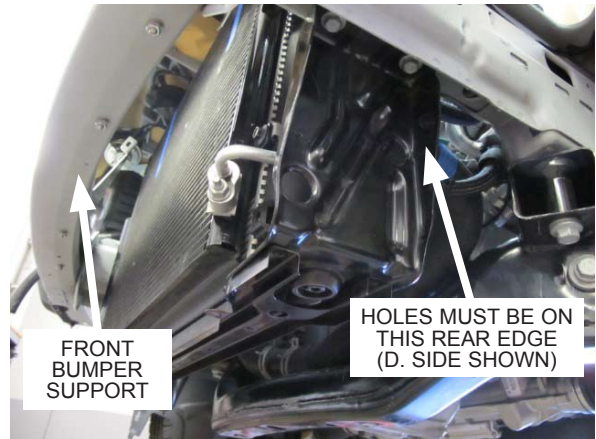

Fig. 4-k: Reinstall lower radiator support

5. ENGINE COOLING SYSTEM MODIFICATION

- A. Using a pair of pliers to remove the spring clamp, remove the coolant reservoir hose that is attached to the bottom side of the coolant reservoir.



Fig. 5-a: Detach coolant reservoir hose from bottom side of coolant reservoir

- B. Down near the K-member you'll see a large diameter coolant hose with a plastic tee with a smaller diameter coolant hose attached to it. The smaller diameter hose is the coolant reservoir hose. Using a pair of pliers to remove the spring clamp, remove the hose from the plastic tee and remove the hose from the vehicle. Keep the two spring clamps and protective cover, but discard the hose as it will not be reused.



Fig. 5-b: Detach coolant reservoir hose from plastic tee

- C. In order to make space for discharge tubes, the plastic tee will need to be rotated 180° clockwise. Use a pair of pliers to temporarily move the two spring clamps as shown.

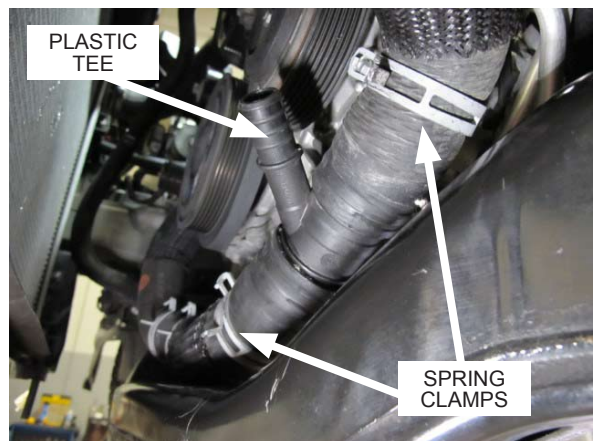

Fig. 5-c: Temporarily move two spring clamps

5. ENGINE COOLING SYSTEM MODIFICATION

- D. Rotate the plastic tee 180° clockwise so the smaller diameter leg is pointed towards the back of the vehicle. Once the tee is rotated, proceed to reinstall the OEM spring clamps.



Fig. 5-d: Rotate plastic tee 180° clockwise

- E. Locate the provided 1.5' length of 3/4" I.D. hose, 3/4" x 90° rubber elbow, brass hose mender, and two 28.6 stepless clamps. Assemble the components as shown and secure the two 28.6 stepless clamps. Slide the OEM protective cover over the hose at this time.

NOTE: One of the legs on the 3/4" x 90° is slightly longer than the other. In this instance, the brass hose mender will be inserted into the shorter leg.



Fig. 5-e: Assemble new coolant reservoir hose as shown

- F. Install the new coolant reservoir hose assembly to the plastic tee, then route the other end of the hose towards the bottom of the coolant reservoir. Reuse the spring clamp to secure the hose to the plastic tee.

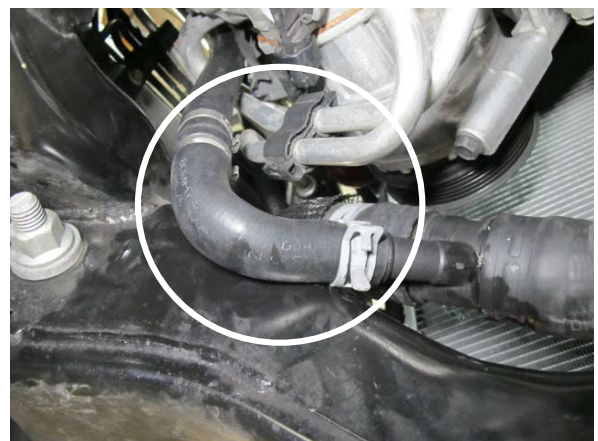

Fig. 5-f: Install 90° end of new coolant reservoir hose to plastic tee

5. ENGINE COOLING SYSTEM MODIFICATION

- G. Attach the remaining end of the smaller diameter coolant hose to the bottom of the coolant reservoir. Reuse the spring clamp to secure the hose.



Fig. 5-g: Attach coolant hose to coolant reservoir

- H. Verify that the coolant drain valve is closed, then proceed to refill the engine coolant system. Check for any leaks while you refill the engine coolant system.



Fig. 5-h: Close coolant drain valve and refill engine coolant system

This page was left intentionally blank.

6. S/C MOUNTING BRACKET ASSEMBLY INSTALLATION



Use blue threadlocker on all fasteners in this section.

- A. The supercharger mounting bracket comes preassembled. In order to be able to install the serpentine belt, the pulley guard will need to be removed. Using a 3/16" hex tool, remove the two 1/4"-20 x 1/2" socket head cap screws securing the pulley guard to the supercharger mounting bracket. Set the screws and pulley guard aside. They will be reinstalled in a later step.

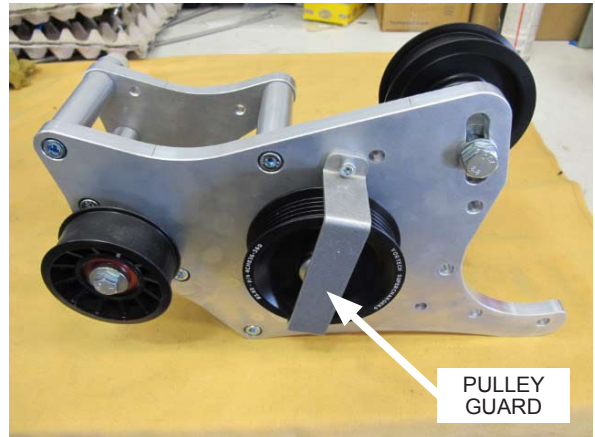

Fig. 6-a: Remove pulley guard

- B. Some of the hardware used to mount the supercharger mounting bracket assembly to the driver side cylinder head is blocked by the serpentine belt idler pulley. Temporarily remove the serpentine belt idler pulley and its hardware and set aside for reinstallation in a later step.



Fig. 6-b: Remove serpentine belt idler pulley

- C. In order to make space for mounting of the supercharger to the supercharger mounting bracket assembly, the cog belt idler pulley and its hardware will need to be removed and set aside for reinstallation in a later step.

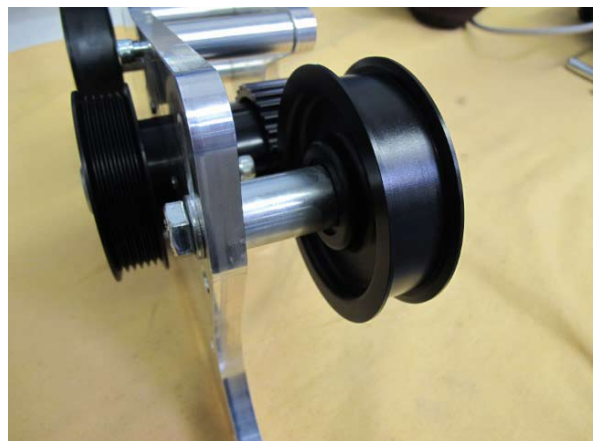

Fig. 6-c: Remove cog belt idler pulley

6. S/C MOUNTING BRACKET ASSEMBLY INSTALLATION

- D. The supercharger mounting bracket assembly will be mounted to the driver side cylinder head using three M8 x 85mm and one M8 x 110mm socket head cap screws. In Fig. 5-d, you will notice a spacer installed to the M8 x 110mm screw. Verify that the spacer installed in this location is the .500" length spacer.

NOTE: There is a .360" length spacer included with this supercharger bracket assembly. Proceed to discard that spacer as it is not used in this application

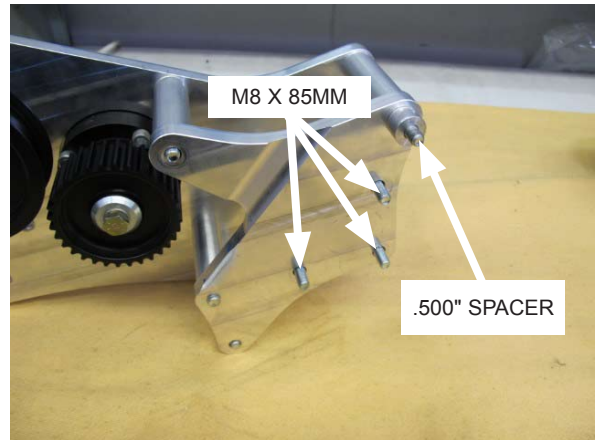

Fig. 5-d: S/C mounting bracket hardware

- E. Remove the harness that is attached to the front of driver side valve cover. Next, you will notice that there are four threaded holes on the driver side cylinder head. The supercharger mounting bracket assembly will be mounted to the driver side cylinder head using these four threaded holes.

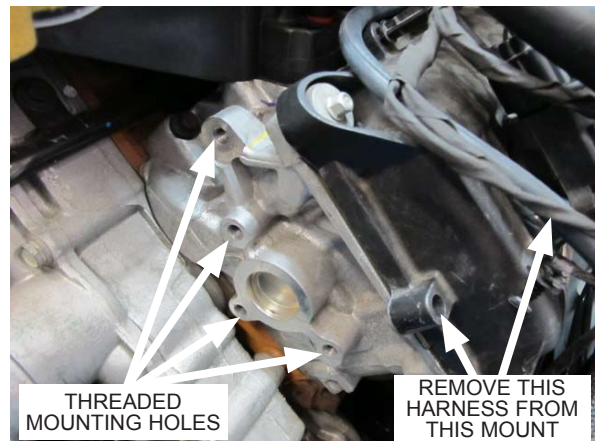

Fig. 5-e: Driver side cylinder head

- F. Place the supercharger mounting bracket assembly in front of the driver side cylinder head. Using a 6mm hex tool, attach the M8 x 110mm socket head cap screw and the .500" length spacer as a pivot on the highest threaded mounting hole on the driver side cylinder head. Be sure that the .500" length spacer is sandwiched between the supercharger mounting bracket assembly & the driver side cylinder head.

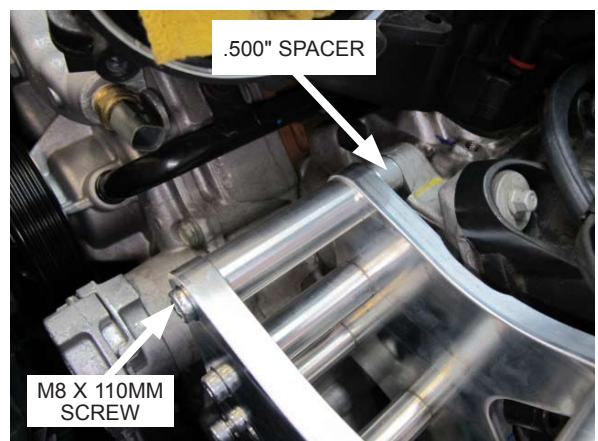

Fig. 5-f: Loosely attach S/C mounting bracket assembly to driver side cylinder head

6. S/C MOUNTING BRACKET ASSEMBLY INSTALLATION

- G. Using a 6mm hex tool, loosely attach the three M8 x 85mm socket head cap screws to the remaining three threaded holes on the driver side cylinder head. Now that all four M8 screws are in place, proceed to secure them to the driver side cylinder head.

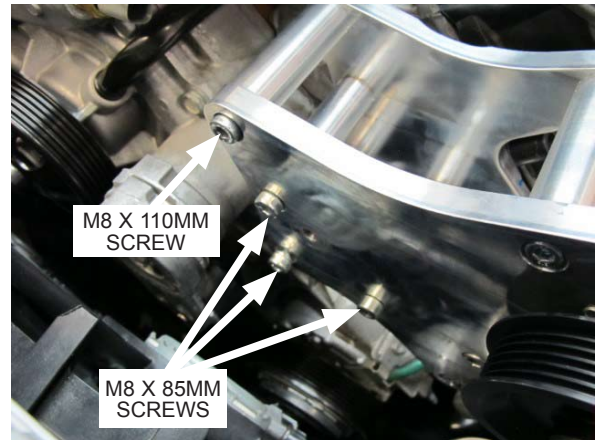

Fig. 6-g: Secure S/C mounting bracket hardware

- H. Locate the previously removed serpentine belt idler pulley and its hardware. Reinstall it to the supercharger mounting bracket assembly, making sure that the hardware is in the same order in which it was removed.

NOTE: If by accident you forget the order of the hardware for the serpentine belt idler pulley, refer to **Appendix A** near the back of this manual for the supercharger mounting bracket assembly diagram.



Fig. 6-h: Reinstall serpentine belt idler pulley

- I. Locate **Appendix B** near the back of this manual for the belt routing diagram and loosely route the provided serpentine drive belt as shown. Once in position, use a 3/8" drive ratchet or 3/8" drive breaker bar and rotate the belt tensioner clockwise, then slide the serpentine drive belt under the smooth idler pulley located on the passenger side of the engine, near the upper radiator hose. Once the belt is in position and properly routed, release the tension on the belt tensioner.

NOTE: The serpentine drive belt will be a tight fit. We suggest having a helper assist you during the installation of the serpentine drive belt.



Fig. 6-i: Slide serpentine belt under OEM passenger side smooth idler pulley

6. S/C MOUNTING BRACKET ASSEMBLY INSTALLATION

- J. Locate the previously removed pulley guard and two 1/4"-20 x 1/2" screws. Using a 3/16" hex tool, reinstall the pulley guard to the super-charger mounting bracket assembly.



Fig. 6-j: Reinstall pulley guard

- K. Using a zip tie, secure the harness removed in step E to the A/C line as shown.

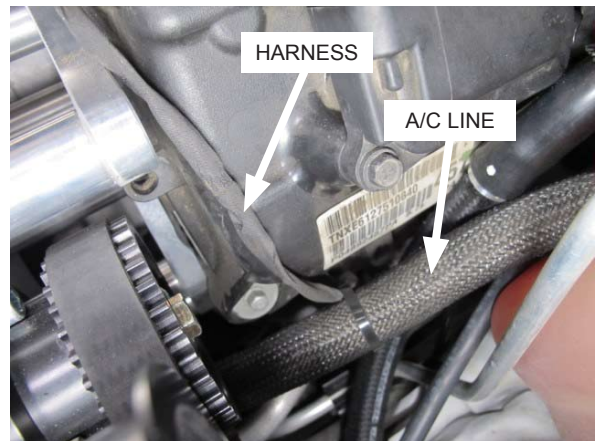

Fig. 6-k: Secure harness to A/C line

7. A/W COOLER, HEAT EXCHANGER & DISCHARGE TUBE INSTALLATION

- A. Locate the air/water cooler, 1/2" NPT x 3/4" barbed straight fitting, and 1/2" NPT x 3/4" barbed 45° fitting and assemble them as shown, making sure the 45° fitting is pointed down. Be sure to use pipe sealant on both threads of the fittings.

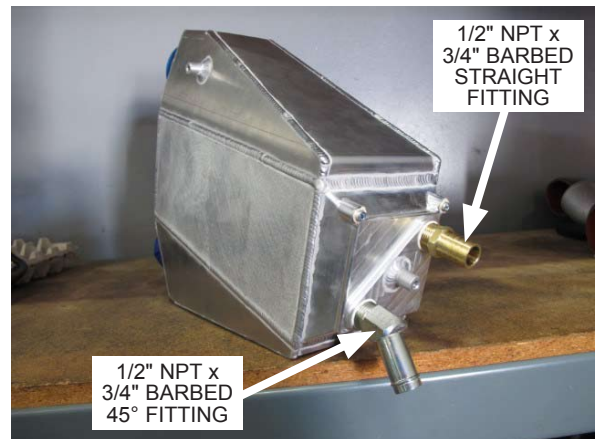

Fig. 7-a: Install fittings to air/water cooler

- B. In order to make space for discharge tube 'A' and the supercharger, it will be necessary to remove a section of the inner wheel well where the airbox once sat, located just to the right of the driver side frame rail. Detach the harness that runs along the top side of the wheel well, then using a cutting tool, remove the section of wheel well. Deburr any sharp edges. Fig. 7-b shows the wheel well already modified.

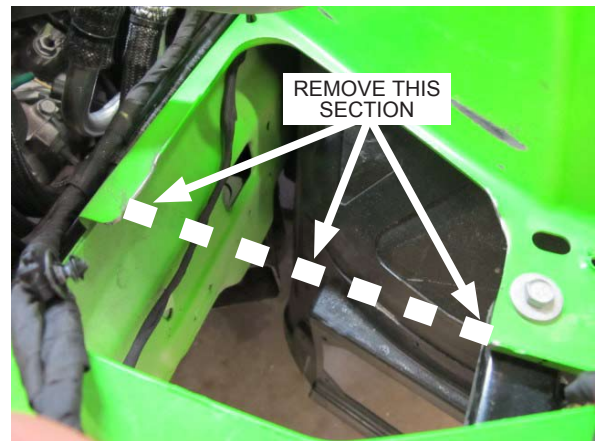

Fig. 7-b: Modify driver side inner wheel well as shown

- C. Before beginning the installation of the air/water cooler, it is necessary to cover the front of the A/C condenser with a large piece of cardboard. Using the box the supercharger kit was shipped in, cut a piece large enough to cover most of the A/C condenser. This helps protect the A/C condenser during installation, but also leaves enough room between the A/C condenser and air/water cooler once the air/water cooler is installed. Use tape to secure the cardboard to the A/C condenser.

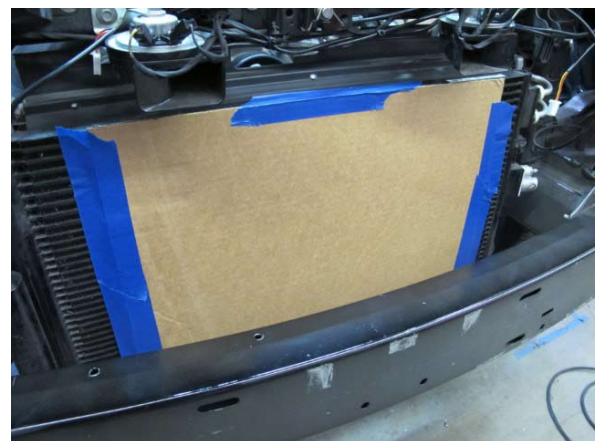

Fig. 7-c: Cover A/C condenser with cardboard

7. A/W COOLER, HEAT EXCHANGER & DISCHARGE TUBE INSTALLATION

- D. Located on the lower driver side of the radiator is an aluminum bracket secured by a screw. Using a 10mm socket, remove the screw and aluminum bracket. Discard the aluminum bracket, but keep the screw.



Fig. 7-d: Remove aluminum bracket and screw

- E. Located on the lower passenger side of the radiator is another screw. Using a 10mm socket, remove the screw and set it aside.



Fig. 7-e: Remove screw

- F. Locate the provided heat exchanger. The side of the heat exchanger with the two ports is the passenger side of the heat exchanger. Locate the provided passenger side heat exchanger bracket, two 1/4"-20 x .50" screws, and two 1/4" washers. Loosely install the passenger side heat exchanger bracket to the heat exchanger as shown.



Fig. 7-f: Install passenger side heat exchanger bracket

7. A/W COOLER, HEAT EXCHANGER & DISCHARGE TUBE INSTALLATION

- G. The side of the heat exchanger without any ports is the driver side of the heat exchanger. Locate the provided driver side heat exchanger bracket, two 1/4"-20 x .50" screws, and two 1/4" washers. Loosely install the driver side heat exchanger bracket to the heat exchanger as shown.



Fig. 7-g: Install driver side heat exchanger bracket

- H. Using the screw removed in step E, loosely install the passenger side of the heat exchanger assembly to the radiator.



Fig. 7-h: Install passenger side of heat exchanger assembly

- I. Using the screw removed in step D, loosely install the driver side of the heat exchanger assembly to the radiator. Once in position, secure all of the heat exchanger assembly hardware.



Fig. 7-i: Install driver side of heat exchanger assembly

7. A/W COOLER, HEAT EXCHANGER & DISCHARGE TUBE INSTALLATION

- J. In order to provide space for the upper air/water cooler support bracket, the driver side horn will need to be relocated. Using a 10mm socket, remove the screw securing the driver side horn to the core support. Remove the horn, then thread the screw back into its original hole. The wiring harness for the driver side horn is attached to the core support. Using a panel removal tool, remove the harness from the core support.



Fig. 7-j: Remove driver side horn

- K. Using a 10mm socket, remove the nut securing the horn bracket to the horn, then discard the horn bracket. It will not be reused. Next, locate the provided horn bracket and install it to the horn as shown. Secure with the previously removed nut.



Fig. 7-k: New horn bracket

- L. Located on the upper passenger side of the radiator is a mounting boss and screw. Using a 10mm socket, remove the screw and relocate the driver side horn to this location. Secure using the same screw.



Fig. 7-l: Relocate driver side horn to upper radiator

7. A/W COOLER, HEAT EXCHANGER & DISCHARGE TUBE INSTALLATION

- M. Using a 10mm socket, remove the driver side hood latch mount screw.



Fig. 7-m: Remove driver side hood latch mount screw

- N. Locate the provided upper air/water cooler support bracket, 1/4"-20 x .50" hex head cap screw and 1/4" washer. Loosely install them to the upper air/water cooler mount as shown.

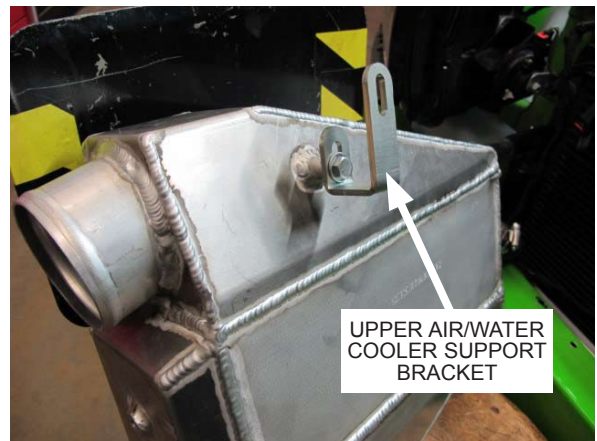

Fig. 7-n: Install upper air/water cooler support bracket

- O. In order to provide space for the top section of the air/water cooler, it will be necessary to clearance the front bumper cover mount. Using a grinding tool, trim away at the underside of the front bumper cover mount, periodically stopping to check clearance with the air/water cooler. Once there is enough clearance, loosely secure the air/water cooler to the driver side hood latch mount and loosely secure using the previously removed screw.

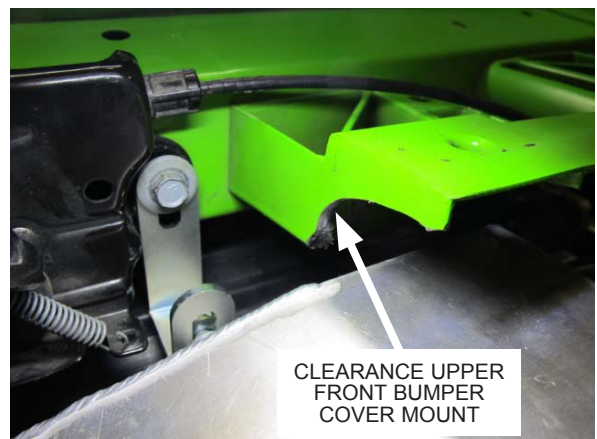

Fig. 7-o: Clearance the front bumper cover mount

7. A/W COOLER, HEAT EXCHANGER & DISCHARGE TUBE INSTALLATION

P. You will notice that there are two existing holes on top of the front bumper support, near the passenger side. In this application, we it is only necessary to use the existing hole furthest to the left. In order to secure the passenger side air/water cooler support bracket with the provided hardware, it will be necessary to drill completely through the existing hole, as well as making an additional hole. Temporarily secure the provided passenger side air/water cooler support bracket to the air/water cooler using one of the provided 1/4"-20 x .50" socket head cap screws and one 1/4" washer. Using the passenger side air/water cooler bracket as a template, line up the long slot on the bracket with the existing hole. Using the shorter slot as a template, make a mark at the center of the slot.

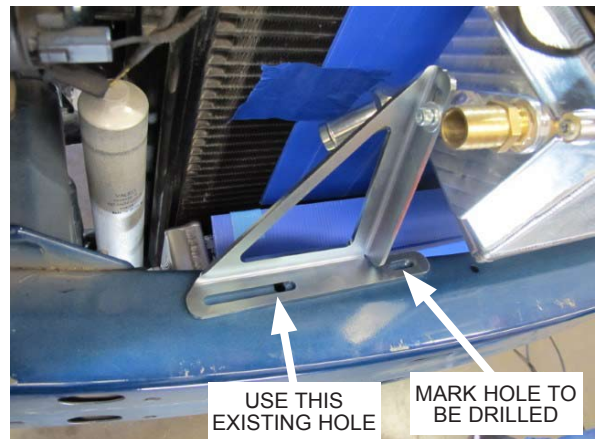

Fig. 7-p: Mark the holes to be drilled on the passenger side of the front bumper support

Q. In order to secure the passenger side air/water cooler support bracket with the provided hardware, it will be necessary to drill two holes completely through the driver side of the front bumper support. Temporarily secure the provided driver side air/water cooler support bracket to the air/water cooler using one of the provided 1/4"-20 x .50" socket head cap screws and one 1/4" washer. Using the driver side air/water cooler bracket as a template, make a mark in the center of both slots.

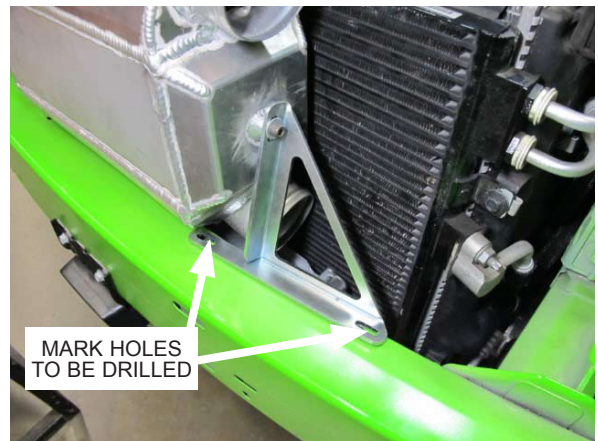

Fig. 7-q: Mark the two holes to be drilled on the driver side of the front bumper support

R. Once all three holes are marked, remove the air/water cooler and all three air/water cooler brackets from the vehicle. Center punch the three holes to be drilled. Using the provided 9/32" x 6" length drill bit and a drill motor, drill the three holes through the front bumper support, then drill through the existing hole. Be sure that the drill bit remains perpendicular to the front bumper support during this process.

NOTE: Periodically stop and allow the drill bit to cool down. Overheating the drill bit may cause it to dull and potentially break. We suggest using cutting oil to ease this step.



Fig. 7-r: Drill holes in front bumper support

7. A/W COOLER, HEAT EXCHANGER & DISCHARGE TUBE INSTALLATION

- S. Locate discharge sleeve 'C' (S-shaped) that has two 45° bends in it. Notice one end of the sleeve is cut at an angle. The angled end of the sleeve will be installed to the air/water cooler. Keep this in mind for the next step.



Fig. 7-s: Discharge sleeve 'C'

- T. Orient the air/water cooler as shown. Notice that the 45° fitting on the passenger side is pointed down. Loosely install discharge sleeve 'C' and #44 hose clamp to the outlet of the air/water cooler, making sure that the angled end of discharge sleeve 'C' sits flush with the air/water cooler.

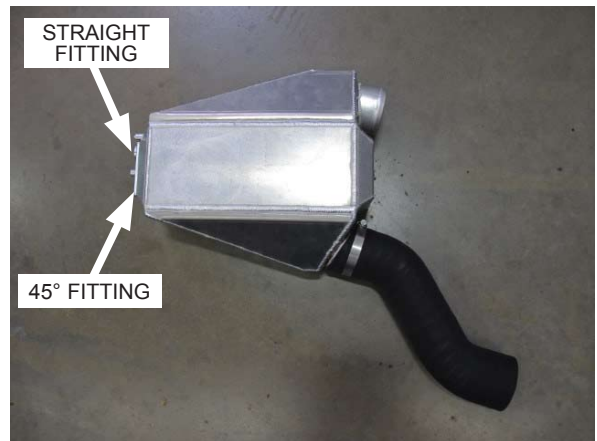

Fig. 7-t: Install discharge sleeve 'C' to the air/water cooler as shown

- U. Slide the air/water cooler into position, routing discharge sleeve 'C' behind the front bumper support, then down under driver side frame rail. If you removed the upper air/water cooler bracket from the air/water cooler, loosely reinstall it at this time. Next, loosely resecure the upper air/water cooler support bracket to the driver side hood latch mount and secure using the previously removed hood latch mount screw.



Fig. 7-u: Loosely install upper air/water cooler support bracket and air/water cooler

7. A/W COOLER, HEAT EXCHANGER & DISCHARGE TUBE INSTALLATION

- V. Using two 1/4"-20 x 5.00" screws, one 1/4"-20 x .50" screw, two 1/4"-20 nylock nuts, and five 1/4" washers, loosely install the driver side air/water cooler support bracket to the front bumper support and the driver side of the air/water cooler.



Fig. 7-v: Loosely install driver side air/water cooler support bracket

- W. Using two 1/4"-20 x 5.00" screws, one 1/4"-20 x .50" screw, two 1/4"-20 nylock nuts, and five 1/4" washers, loosely install the passenger side air/water cooler support bracket to the front bumper support and the passenger side of the air/water cooler.



Fig. 7-w: Loosely install passenger side air/water cooler support bracket

- X. At this time, proceed to secure all of the hardware that secures all three air/water cooler support brackets to the vehicle. Once that hardware is secure, lift the air/water cooler up off of the front bumper support, then proceed to secure the two 1/4"-20 x .50" socket head cap screws and one 1/4"-20 x .50" hex head cap screw that secure the air/water cooler to its three support brackets. While you are securing the air/water cooler, make sure that it isn't being pressed into the A/C condenser. Adjust as necessary, then remove the cardboard that was used to protect the A/C condenser.

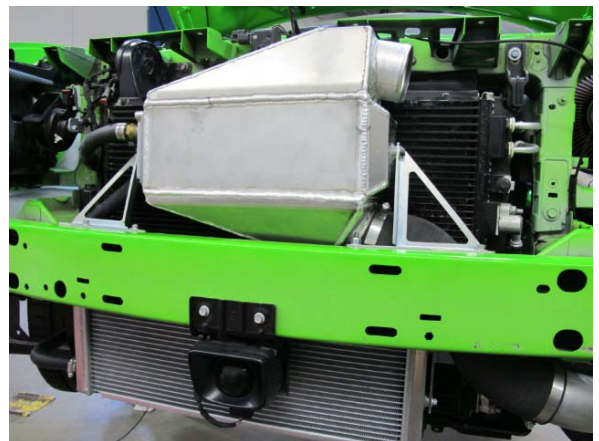

Fig. 7-x: Install air/water cooler

7. A/W COOLER, HEAT EXCHANGER & DISCHARGE TUBE INSTALLATION

- Y. Locate discharge tube 'D'. Route the long end of the tube up into the engine compartment, as close to the radiator fan shroud as possible. Loosely install the short end of the tube into discharge sleeve 'C'.

NOTE: It may be necessary to further clear the radiator fan shroud to allow discharge tube 'D' to fit properly. Adjust as necessary.



Fig. 7-y: Loosely install discharge tube 'D'

- Z. Line up the mounting bracket on discharge tube 'D' with the two previously drilled holes on the lower radiator support and secure using two 1/4"-20 x .50" screws, two 1/2"-20 nylock nuts, and four 1/4" washers.

NOTE: The holes on the bracket that's welded to discharge tube D are slotted to allow for adjustment of the tube if necessary.



Fig. 7-z: Secure discharge tube 'D' to lower radiator support

- AA. Locate the factory air inlet tube and remove the intake air temperature sensor. Next, locate discharge sleeve 'E' (with molded boss). Insert the intake air temperature sensor into the molded boss, making sure that the alignment tab on the intake air temperature sensor is inserted into the alignment slot on the molded boss. Once in position, secure using the provided 28.6 stepless clamp.



Fig. 7-aa: Install IAT sensor to molded boss on discharge sleeve 'E'

7. A/W COOLER, HEAT EXCHANGER & DISCHARGE TUBE INSTALLATION

- AB. Install discharge sleeve 'E' to discharge tube 'D' and to the throttle body, making sure that discharge sleeve 'E' is not rubbing against any sharp edges or pressed against the pulley guard on the supercharger mounting bracket assembly. Once in position, secure using a #48 and #56 hose clamp, then reconnect the IAT sensor.

NOTE: Further trimming of the radiator fan shroud may be necessary to provide proper clearance for discharge sleeve E. Trim as necessary.



Fig. 7-ab: Install discharge sleeve 'E' and reconnect IAT sensor

- AC. Using an 8mm socket, remove the four screws securing the driver side headlight to the vehicle. Once the headlight is loose, proceed to remove it from the vehicle and disconnect the connector. Set the headlight aside.



Fig. 7-ac: Remove driver side headlight

- AD. Locate discharge sleeve 'B'. You will notice that one end of the sleeve is longer than the other. Loosely attach the long end of the sleeve to the air/water cooler.



Fig. 7-ad: Install discharge sleeve 'B'

7. A/W COOLER, HEAT EXCHANGER & DISCHARGE TUBE INSTALLATION

AE. You will notice that discharge sleeve 'B' has a flat spot to it. This is to allow for clearance behind the driver side headlight. Test fit the headlight and adjust discharge sleeve 'B' to fit behind the headlight, making sure it doesn't get pinched and is clear from any sharp edges. Once in position, proceed to reinstall the headlight and secure using the four previously removed screws. Reconnect the headlight at this time.



Fig. 7-ae: Adjust discharge sleeve 'B' and install driver side headlight

AF. Locate discharge tube 'A' and install the bypass valve and filter as shown. Secure the bypass valve to the discharge tube using the two 1/4"-20 x .750" socket head cap screws provided with the bypass valve.



Fig. 7-af: Assemble discharge tube 'A' as shown

AG. Slide a #48 hose clamp onto discharge sleeve 'B'. Loosely install discharge tube 'A' into discharge sleeve 'B' as shown, making sure to route discharge tube 'A' up into the engine compartment. Leave the hose clamp loose at this time.

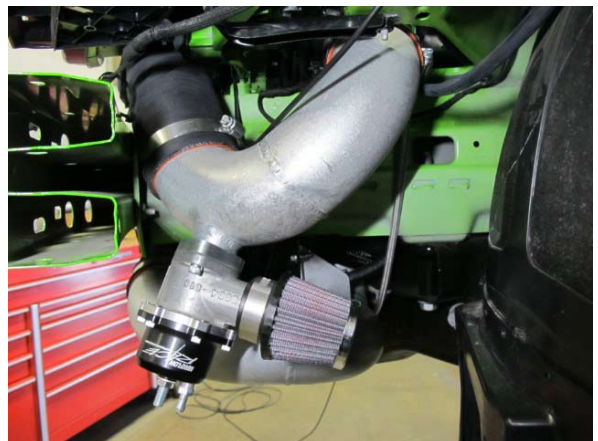

Fig. 7-ag: Loosely install discharge tube 'A' to discharge tube 'B'

7. A/W COOLER, HEAT EXCHANGER & DISCHARGE TUBE INSTALLATION

- AH. Locate the previously removed ambient air temperature sensor. On the back side of the sensor mount there is a locating tab that needs to be grinded down. Proceed to grind down the locating tab, then using an M6 x 10mm screw and 1/4" washer, secure the ambient air temperature sensor to the underside of the front bumper support, near the passenger side.

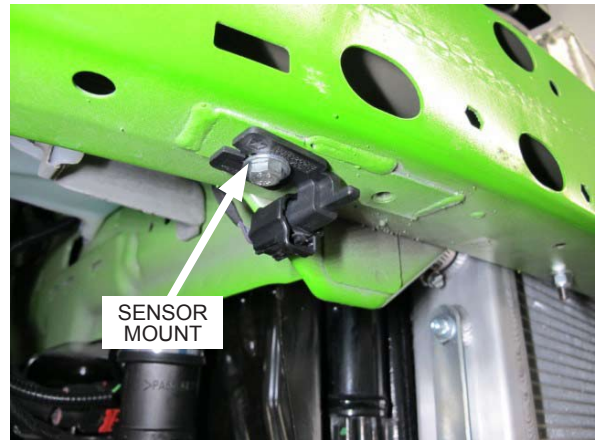

Fig. 7-ah: Reinstall ambient air temperature sensor as shown

8. AIR INLET ASSEMBLY, BYPASS VALVE SIGNAL HOSE & S/C INSTALLATION

- A. Locate the provided air filter. With the 90° plastic fitting installed into the air filter, place the air filter into the vehicle as shown. Next, install a $\text{Ø}3.00$ to $\text{Ø}2.75$ " silicone reducer sleeve, one #48 hose clamp, and one #44 hose clamp to the other end of discharge tube 'A'. Leave the hose clamps loose at this time.

NOTE: The air filter must be in place prior to the supercharger being installed, as it is not possible to install the air filter after the supercharger is installed.



Fig. 8-a: Place air filter into position and install silicone sleeve to discharge tube 'A'

- B. Prior to installing the supercharger to the supercharger mounting bracket assembly, it is suggested that you lubricate the threads in the mounting bosses on the supercharger. To do this, use four 3/8-16 x 1.25" screws and lightly coat the screw threads with lubricant, then screw them into the mounting bosses until they bottom out. Once complete, remove the screws from the mounting bosses. This process makes it easier to install the screws into the supercharger.



Fig. 8-b: Lubricate supercharger mounting boss threads



Use blue threadlocker on all fasteners in this step.

- C. Place the supercharger onto the supercharger mounting bracket assembly and begin to thread the four 3/8-16 x 1.25" supercharger mounting screws by hand, making sure to use 3/8" washers on all screws. Once in position, proceed to tighten the four 3/8-16 x 1.25" supercharger mounting screws.



Fig. 8-c: Install supercharger to supercharger mounting bracket assembly

8. AIR INLET ASSEMBLY, BYPASS VALVE SIGNAL HOSE & S/C INSTALLATION

- D. Locate the previously removed cog belt idler pulley and its hardware and reinstall it to the supercharger mounting bracket assembly, making sure that the hardware is in the same order in which it was removed. Slide the cog belt over both cog pulleys and under the cog belt idler pulley. Using the cog belt idler pulley as a belt tensioner, push it down so it starts to tension the cog belt, then secure the cog belt idler pulley hardware.

NOTE: Do not apply excessive tension to the cog belt. By design, cog belts do not require the same amount of tension as a serpentine belt. Under the correct amount of tension, you should be able to easily "twist" the straight section of the cog belt about a 1/4 turn.



Fig. 8-d: Tension cog belt

- E. Locate the OEM breather hose. Notice one leg of the hose is slightly shorter than the other. Using hose cutters, remove 2.00" inches from the shorter end of the hose.



Fig. 8-e: Modify OEM breather hose

- F. Locate the provided 3/4" to 1/2" reducer fitting and 1/2" oil drain hose. Insert the 1/2" end of the reducer fitting into the 1/2" oil drain hose, then install the long leg of the modified OEM breather hose to the 3/4" end of the reducer fitting. No hose clamps are required for this step.



Fig. 8-f: Breather hose assembly

8. AIR INLET ASSEMBLY, BYPASS VALVE SIGNAL HOSE & S/C INSTALLATION

- G. Install the previously assembled breather hose assembly to the engine as shown. The modified OEM breather hose gets installed to its original location. Attach the other end of the breather hose assembly to the 1/2" x 90° fitting on the air filter. No hose clamps are required for this step.



Fig. 8-g: Install breather hose assembly

- H. Proceed to install the air filter to the supercharger inlet and secure using the hose clamp provided with the air filter. Next, proceed to install discharge tube 'A' to the supercharger outlet, but do not tighten the hose clamps at this time.



Fig. 8-h: Secure air filter and discharge tube A to supercharger

- I. With all discharge tubes and sleeves installed, verify that everything is free and clear of any obstructions and adjust as necessary. Once in place, proceed to tighten all hose clamps using a 5/16" nut driver or flathead screw driver.



Fig. 8-i: Secure discharge tubes and discharge sleeves

8. AIR INLET ASSEMBLY, BYPASS VALVE SIGNAL HOSE & S/C INSTALLATION

- J. There is a 3/8" vacuum line attached to the brake booster. Cut the 3/8" vacuum line and install the provided brass vacuum tee. Locate the provided 7/32" vacuum hose and attach it to the vacuum tee, then route the vacuum line along the fuel injector harness, then under the supercharger and down towards the bypass valve on discharge tube 'B'.

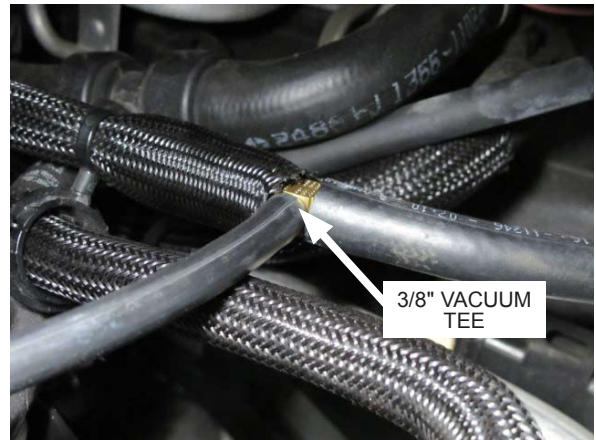

Fig. 8-j: Install vacuum tee

- K. Attach the 7/32" vacuum hose to the fitting located on the bypass valve lid.



Fig. 8-k: Attach vacuum hose to bypass valve

9. A/W COOLING SYSTEM INSTALLATION

- A. Locate the provided auxiliary water pump harness. You will notice one end of the harness has a 10A fuse tap attached to it. Verify that this fuse is not damaged as it will replace a fuse in the fuse box in a later step.



Fig. 9-a: Auxiliary water pump harness

- B. Using a 5/8" drill bit, drill through the back of the fuse box cover as shown. Pass the fuse tap through the hole, then secure the rubber grommet to the fuse box cover.



Fig. 9-b: Drill fuse box cover, install grommet and route wire into fuse box

- C. On the under side of the fuse box cover is a fuse diagram. Locate and remove fuse #37, then replace it with the fuse tap as shown. Reinstall the fuse box cover, then route the harness down towards the passenger side of the lower radiator support making sure to keep it away from sharp edges and moving objects.



Fig. 9-c: Install fuse from water pump harness as shown

9. A/W COOLING SYSTEM INSTALLATION

- D. In order to provide clearance for the auxiliary water pump, the plastic fastener for the large harness connector will need to be removed. Disconnect the large harness connector, then using a pry tool, remove the large harness connector from its mounting location.

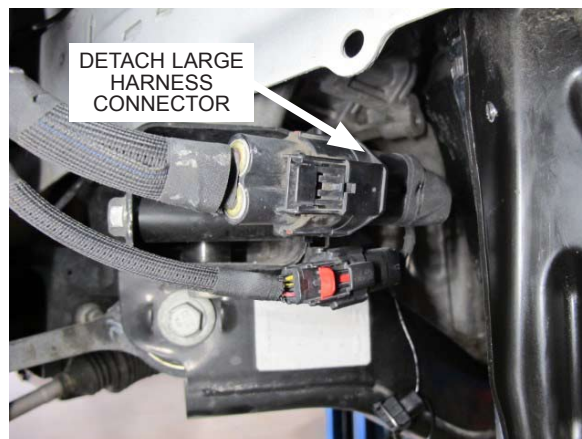

Fig. 9-d: Large harness connector

- E. Remove the plastic harness connector fastener from the connector and discard. It will not be reused. Reconnect the large harness connector at this time.



Fig. 9-e: Remove plastic harness connector fastener

- F. Using zip tie, secure the large harness connector to its original mount. Next, using an adel clamp, one 1/4"-20 x .50" socket head cap screw, one 1/4"-20 nylock nut, and one 1/4" washer, loosely mount the auxiliary water pump to the hole previously drilled on the passenger side of the lower radiator mount, making sure to place the ring terminal from the auxiliary water pump harness between the 1/4"-20 nylock nut and 1/4" washer. Position the auxiliary water pump so the outlet is positioned as shown. Once in position, connect the auxiliary water pump harness to the water pump.

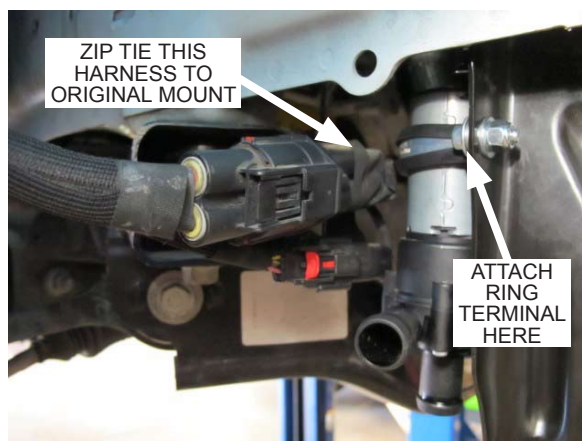

Fig. 9-f: Install the auxiliary water pump

9. A/W COOLING SYSTEM INSTALLATION

- G. In order to provide room for one of the air/water cooling system hoses that gets attached to the heat exchanger, one of the front bumper support screws will need to be removed.

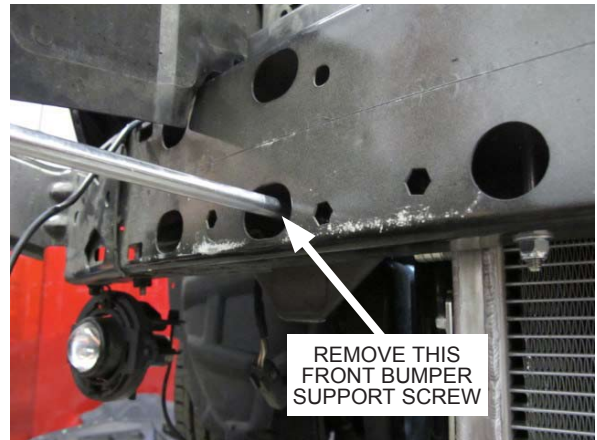

Fig. 9-g: Remove front bumper support screw

- H. Locate the provided M8 x 1.25 x 12mm socket head cap screw and install it where the previously removed front bumper support screw was located.



Fig. 9-h: Shorter front bumper support screw

- I. Locate both of the provided 3/4" x 150° molded hoses. Prior to being installed, they'll need to be modified. Using a pair of hose cutters, remove 1.00" from the short end of both hoses and 1/2" from the long end of both hoses.



Fig. 9-i: Modify 150° molded hose as shown

9. A/W COOLING SYSTEM INSTALLATION

- J. Using one of the modified 3/4" x 150° molded hoses, attach the short end of the hose to the upper port of the heat exchanger. Loosely attach a #10 hose clamp, but do not tighten it at this time.



Fig. 9-j: Install short end of 150° molded hose to heat exchanger

- K. Attach the other end of the modified 150° molded hose to the 45° fitting on the air/water cooler core. Once the hose is in position, proceed to secure this end of the hose with another #10 hose clamp. Be sure to secure the #10 hose clamp installed in the previous step.



Fig. 9-k: Install long end of 150° molded hose to air/water cooler

- L. Using a 13mm socket, remove the nuts that secure the shock mount to the shock tower on the passenger side. Next, locate the provided mounting bracket for the air/water cooling system reservoir and install it as shown, then secure it using the same nuts that secure the shock mount to the shock tower.



Fig. 9-l: Install air/water cooler system reservoir mount

9. A/W COOLING SYSTEM INSTALLATION

- M. Locate the provided air/water cooling system reservoir and install it to the previously installed mount on the shock tower. Secure using the provided M6 nylock nuts and M6 washers.



Fig. 9-m: Install air/water cooler system reservoir to mount

- N. Locate the provided length of 3/4" coolant hose and cut it down to 44". Next, locate the braided sleeve and cut a 57" piece. As you begin to slide the braided sleeve over the 3/4" coolant hose, it will begin to increase in diameter, thus shortening its overall length. Center the braided sleeve on the 3/4" coolant hose and use electrical tape to secure both ends. There should only be a few inches of coolant hose exposed on each end.



Fig. 9-n: 44" length of the 3/4" coolant hose

- O. Locate the provided 1/2" x 90° hose elbow. Measuring from the inside of the 90° bend, cut each leg down to 1.50".

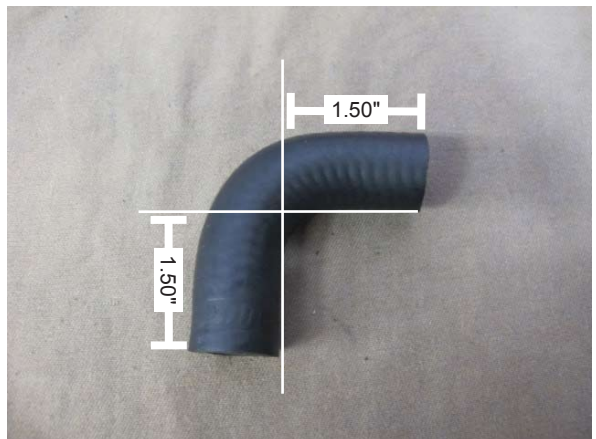

Fig. 9-o: Modify 1/2" x 90° coolant elbow as shown

9. A/W COOLING SYSTEM INSTALLATION

- P. Locate the provided 3/4" x 1/2" x 90° brass reducer fitting and insert the 1/2" end of the fitting into one of the legs of the 1/2" x 90° hose.



Fig. 9-p: Insert brass fitting to 1/2" x 90° coolant hose elbow

- Q. Install the hose and brass fitting assembly to the plastic bung on the rear of the air/water cooling system reservoir and secure using two #6 hose clamps.



Fig. 9-q: Install hose and brass fitting assembly to air/water cooling system reservoir

- R. Locate the 44" length of 3/4" hose and attach one end of the hose to the brass fitting as shown. Secure using a #10 hose clamp.



Fig. 9-r: Attach 44" length of 3/4" coolant hose to the brass fitting as shown

9. A/W COOLING SYSTEM INSTALLATION

- S. Route the 3/4" coolant hose from the air/water cooling system reservoir towards the air/water cooler, making sure to keep it away from the exhaust manifold, as well as sharp and/or moving objects. Secure using provided zip ties.



Fig. 9-s: Route 3/4" coolant hose towards air/water cooler

- T. Pass the 3/4" coolant hose between the radiator and the core support. Make sure the hose doesn't get pinched or kinked.



Fig. 9-t: Pass 3/4" coolant hose between radiator and core support

- U. Attach the 3/4" coolant hose to the straight fitting on the air/water cooler and secure using the provided #10 hose clamp.



Fig. 9-u: Attach 3/4" coolant hose to air/water cooler

9. A/W COOLING SYSTEM INSTALLATION

- V. Locate the provided 3/4" x 90° molded hose. You will notice that one leg of the molded hose is shorter than the other. Loosely install the short leg of the molded hose to the lower port of the heat exchanger. Route the long leg of the hose towards the outlet of the auxiliary water pump and trim the hose down to size, making sure it is not kinked and clear of any sharp edges. Secure the molded hose using two #10 hose clamps. Once this hose is properly installed, go back and tighten the hardware securing the water pump to the lower radiator mount.

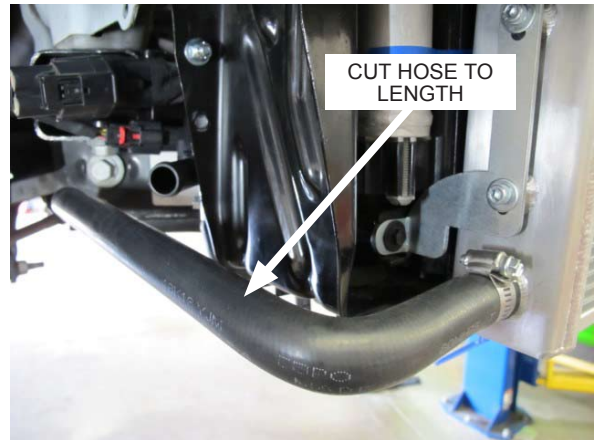

Fig. 9-v: Install 3/4" x 90° hose

- W. Locate the remaining 3/4" x 150° molded hose, 3/4" to 1/2" reducer fitting, 1/2" coolant hose, one #10 hose clamp, one #6 hose clamp, and braided sleeve. Cut the 1/2" coolant hose to 27.5", then cut the braided sleeve to 32". Use the 3/4" to 1/2" reducer fitting to join both hoses together, then secure them using the two hose clamps. Once the hose is assembled, slide the braided sleeve over the 1/2" coolant hose. As you begin to slide the braided sleeve over the 1/2" coolant hose, it will begin to increase in diameter, thus shortening its overall length. Center the braided sleeve on the 1/2" coolant hose and use electrical tape to secure both ends. There should only be a few inches of coolant hose exposed on each end.



Fig. 9-w: 3/4" x 150° to 1/2" coolant hose assembly

- X. Loosely install the 3/4" x 150° molded hose and a #10 hose clamp to the inlet of the auxiliary water pump. With the hose in properly routed, proceed to secure the hose to the electric water pump inlet using the #10 hose clamp. Once this end of the coolant hose assembly is secured, route the other end of this hose up towards the air/water coolant reservoir.



Fig. 9-x: Install coolant hose to electric water pump inlet

9. A/W COOLING SYSTEM INSTALLATION

- Y. Using the coolant hose assembly from the previous step, install the 1/2" end of the coolant hose assembly and a #6 hose clamp to the air/water system coolant reservoir, making sure to keep it away from the exhaust manifold, as well as sharp and/or moving objects. Secure using provided zip ties.

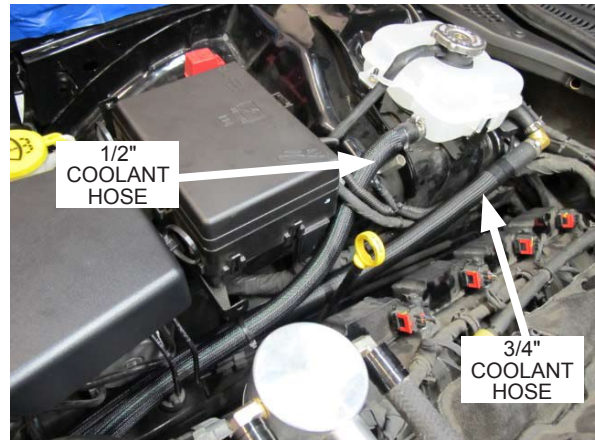

Fig. 9-y: Install coolant hose assembly and route towards electric water pump

- Z. Verify that all hose clamps for the air/water cooling system are secured, then begin to fill the air/water cooling system at the reservoir with 50/50 water/coolant mix. Check for leaks and correct if necessary. In order to properly purge the air/water system of air, the electric water pump needs to be turned on. To do this, the battery will need to be plugged back in and the vehicle turned to *RUN* mode, but **DO NOT START THE ENGINE**. To put the vehicle into *RUN* mode, **KEEP YOUR FOOT OFF OF THE BRAKE AND/OR CLUTCH**, then press the engine start button twice. This will turn on all vehicle accessories as well as turn on the electric water pump for the air/water cooling system. Continue to fill the air/water cooling system until all of the air has been purged. Only fill the air/water coolant reservoir to the line labeled *COLD FULL LEVEL*. Install reservoir cap once complete, then unplug the the battery again.



Fig. 9-z: Fill air/water cooling system with 50/50 water/coolant mix

This page was left intentionally blank.

10. MISC. REASSEMBLY

- A. Reinstall the front bumper cover, reconnect the fog lights, reinstall the engine service panel, and reposition the fender liners. Secure all panels using the previously removed plastic fasteners and hardware.



Fig. 10-a: Reinstall front bumper cover

- B. It will be necessary to modify the front outer edge of the engine cover to allow the breather hose to clear. Test fit the engine cover and modify as necessary.

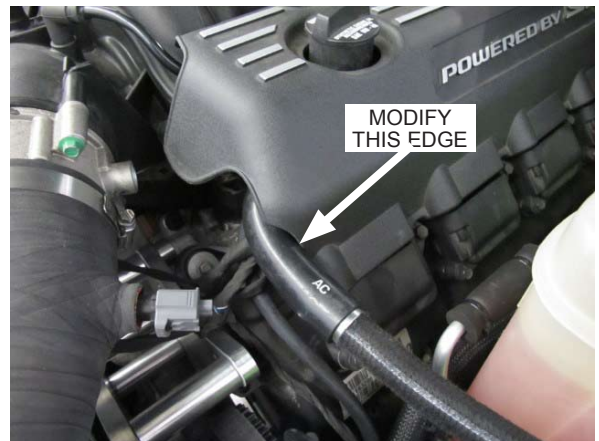

Fig. 10-b: Modify driver side engine cover

- C. Proceed to reinstall both engine covers.



Fig. 10-c: Reinstall both engine covers

This page was left intentionally blank.

11. FINAL CHECK

WARNING: Do not attempt to operate the vehicle until all components are installed and all operations are completed including the final check.

- A. If your vehicle has gone over 15,000 miles since its last spark plug change, you will need to change the spark plugs now *before* test driving the vehicle.
- B. Check all fittings, nuts, bolts and clamps for tightness. Pay particular attention to oil and fuel lines around moving parts, sharp edges and exhaust system parts. Make sure all wires and lines are properly secured with clamps or tie-wraps.
- C. Check all fluid levels, making sure that your tank(s) is/are filled with 91 octane or higher fuel before commencing test drive.
- D. Start the engine and allow to idle a few minutes, then shut off.
- E. Recheck to be sure that no hoses, wires, etc. are near exhaust headers or moving parts. Look also for any signs of fluid leakage.
- F. **PLEASE TAKE SPECIAL NOTE:** Operating the vehicle without ALL the subassemblies completely and properly installed may cause **FAILURE OF MAJOR COMPONENTS.**
- G. Test drive the vehicle.
- H. Always listen carefully for engine detonation. Discontinue heavy throttle usage if detonation is heard.
- I. Read the **STREET SUPERCHARGER SYSTEM OWNER'S MANUAL AND RETURN THE WARRANTY REGISTRATION FORM** within thirty (30) days of purchasing your supercharger system to qualify.

For internally lubricated V3 units only

This supercharger has been factory pre-filled with special Vortech synthetic lubricant. Oil does not need to be added to a brand new unit; however a fluid level check should be performed.

Prior to operating the supercharger on the vehicle and after installation onto the vehicle:

Remove the factory installed flat-head brass shipping plug (not the dipstick) from the top of the supercharger case. Replace the sealed shipping plug with the supplied "vented" plug. Do not operate the supercharger without it. Check the supercharger fluid level.

Fluid level checking procedure:

1. Ensure that the .06" copper sealing washer is located on the dipstick base.
2. Thread the clean dipstick into the unit until it seats.
3. Once the dipstick has seated, remove the dipstick from the unit. Fluid should register in the crosshatched area on the dipstick.
4. **DO NOT OVERFILL!!!** Drain excess fluid from the unit if it is above the maximum level on the dipstick.

Check the fluid level using the dipstick at least every 2,500 miles.

Initial supercharger fluid change must be performed at 2,500 miles. The supercharger fluid must be changed at least every 7,500 miles.

Drain the fluid, refill the unit with 4 oz. of Vortech V3 synthetic lubricating fluid and then confirm proper oil level using the dipstick. **DO NOT OVERFILL!!!**

WARNING: Use of any other fluid other than the special Vortech/Paxton synthetic lubricant will void the warranty and may cause component failure.

APPENDIX A. DIAGRAM, ASSEMBLY, SUPERCHARGER MOUNTING BRACKET

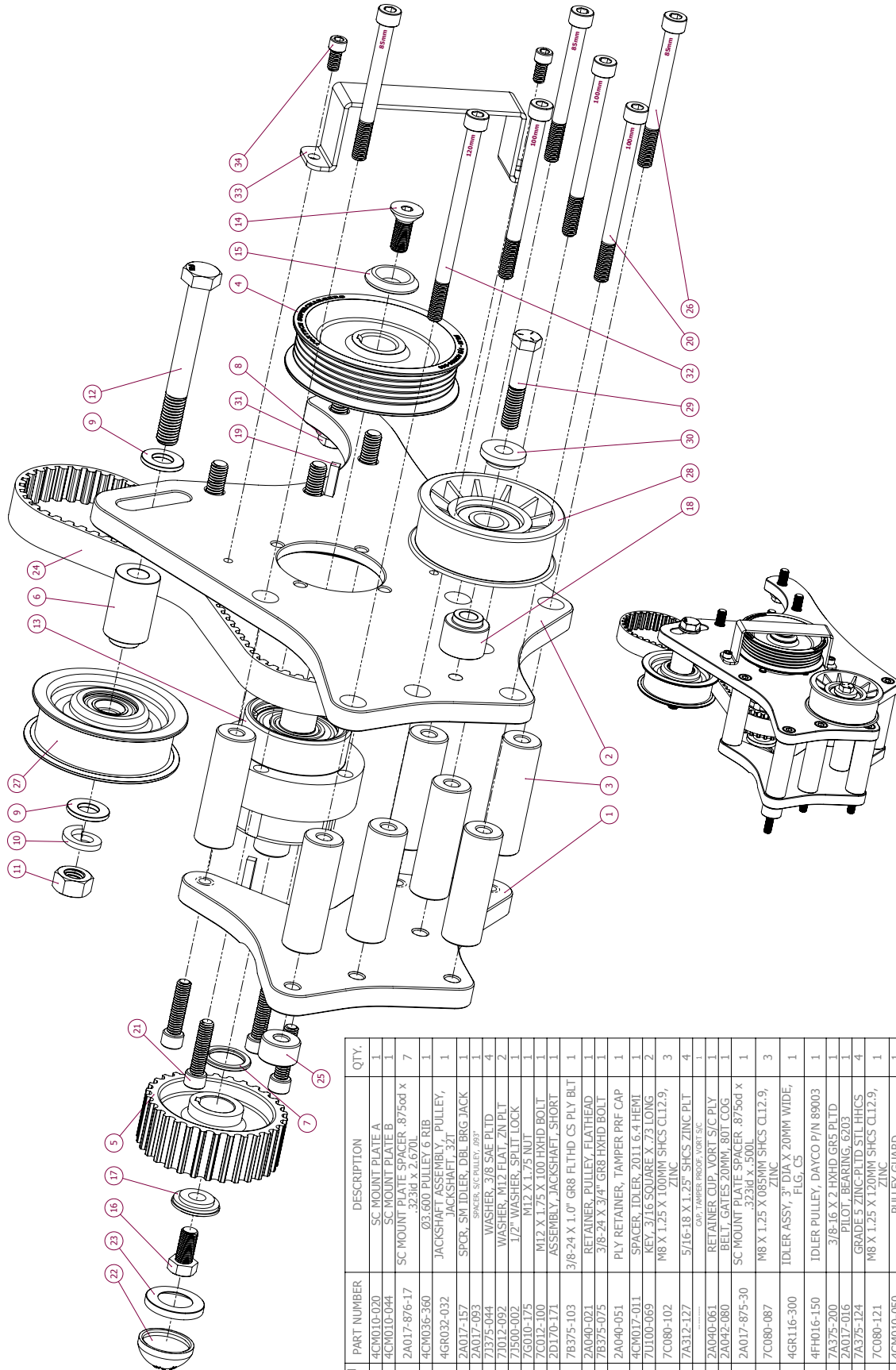

ITEM NO.	PART NUMBER	DESCRIPTION	QTY.
1	4CM010-020	SC MOUNT PLATE A	1
2	4CM010-044	SC MOUNT PLATE B	1
3	2A017-876-17	SC MOUNT PLATE SPACER .8750d x .323d4 x 2.670L	7
4	4CM036-360	.03.600 PULLEY 6 RIB	1
5	4GR032-032	JACKSHAFT ASSEMBLY, PULLEY, JACKSHAFT, 3ZT	1
6	2A017-157	SPCR, SM IDLER, DBL BRG JACK	1
7	2A017-093	SPACER, S/C PULLEY, .093"	1
8	7J375-044	WASHER, 3/8 SAE PLTD	4
9	7J012-092	WASHER, M12 FLAT, ZN PLT	2
10	7J500-002	1/2" WASHER, SPLIT LOCK	1
11	7G010-175	M12 X 1.75 X 100 HXHD BOLT	1
12	7C012-100	M12 X 1.75 X 1.75 NUT	1
13	2D170-171	ASSEMBLY, JACKSHAFT, SHORT	1
14	7B375-103	3/8-24 X 1.0" GR8 FLTHD CS PLY BLT	1
15	2A040-021	RETAINER, PULLEY, FLATHEAD	1
16	7B375-075	3/8-24 X 3/4" GR8 HXHD BOLT	1
17	2A040-051	PLY RETAINER, TAMPER PRF CAP	1
18	4CM017-011	SPACER, IDLER, 2011 6.4 HEMI	1
19	7J100-069	KEY, 3/16 SQUARE X .73 LONG	2
20	7C080-102	M8 X 1.25 X 100MM SHCS CL12.9, ZINC	3
21	7A312-127	5/16-18 X 1.25" SHCS ZINC PLT	4
22	---	CVT DAMPER BELT, VORT S/C	1
23	2A040-061	RETAINER CUP, VORT S/C PLY	1
24	2A042-080	BELT, GATES 20MM, 80T COG	1
25	2A017-875-30	SC MOUNT PLATE SPACER .8750d X .323d4 X .500L	1
26	7C080-087	M8 X 1.25 X 065MM SHCS CL12.9, ZINC	3
27	4GR116-300	IDLER ASSY, 3" DIA X 20MM WIDE, FLG, CS	1
28	4FH016-150	IDLER PULLEY, DAYCO P/N 89003	1
29	7A375-200	3/8-16 X 2 HXHD GR5 PLTD	1
30	2A017-016	PILOT, BEARING, 6203	1
31	7A375-124	GRADE 5 ZINC-PLTD STL HHCS	4
32	7C080-121	M8 X 1.25 X 120MM SHCS CL12.9, ZINC	1
33	4CM010-050	PULLEY GUARD	1
34	7A250-050	1/4-20 X .50" SHCS ZINC PLT	2

P/N: 4CM020-030 v1.1, 03/06/19
 ©2019 Vortech Engineering, Inc.
 All Rights Reserved, Intl. Corp. Secured

APPENDIX B. DIAGRAM, BELT ROUTING

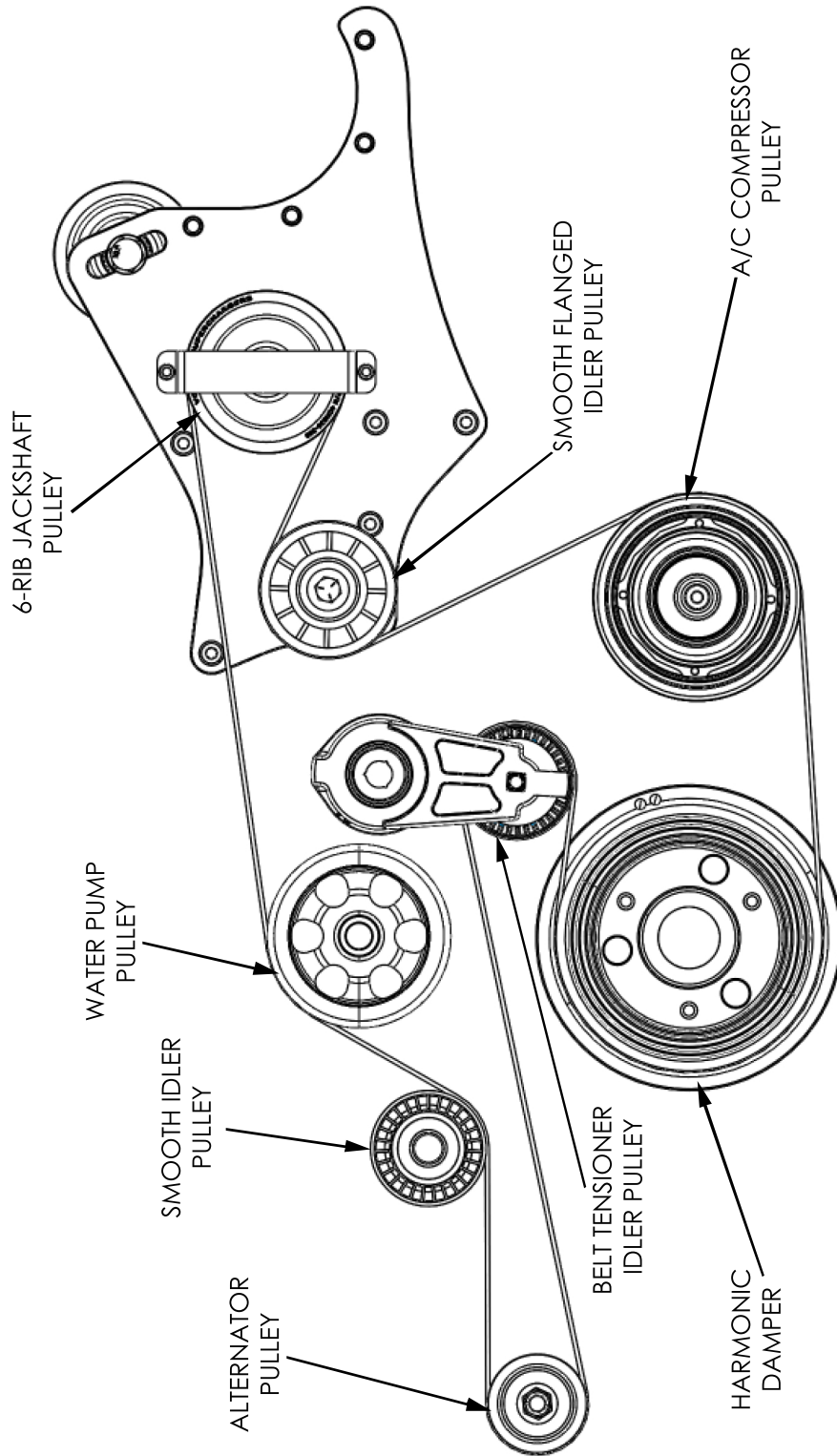



ENGINEERING, INC

1650 Pacific Avenue, Channel Islands, CA 93033-9901 • Phone (805) 247-0226
Fax: (805) 247-0669 • www.vortechsuperchargers.com • M-F 7:00 AM - 3:30 PM (PST)