

Dodge Challenger 6.4L Supercharger System Installation Instructions

2015-2019 Model Year
50 State Smog Legal Per CARB EO# D-213-39

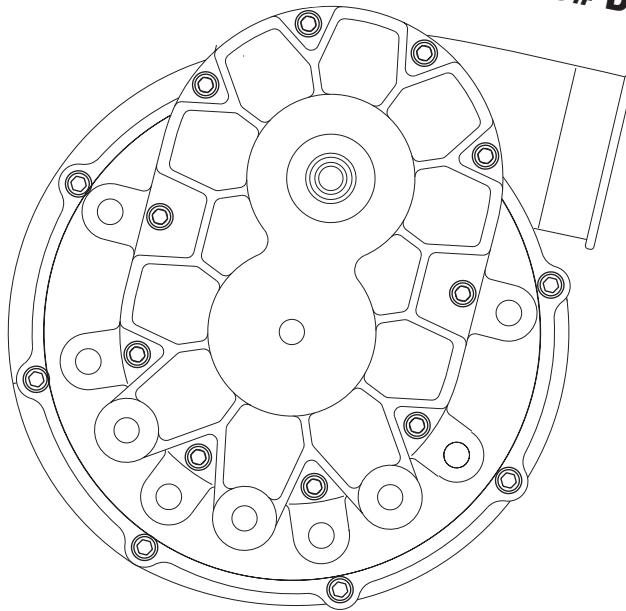

ENGINEERING, INC

1650 Pacific Avenue, Channel Islands, CA 93033-9901 • Phone (805) 247-0226
Fax: (805) 247-0669 • www.vortechsuperchargers.com • M-F 7:00 AM - 3:30 PM (PST)

FOREWORD

This manual provides information on the installation, maintenance and service of the Vortech supercharger kit expressly designed for this vehicle. All information, illustrations and specifications contained herein are based on the latest product information available at the time of this publication. Changes to the manual may be made at any time without notice. Contact Vortech Engineering for any additional information regarding this kit and any of these modifications at (805) 247-0226 7:00am-3:30pm PST.



Take note of the following before proceeding:

1. Proper installation of this supercharger kit requires general automotive mechanic knowledge and experience. Please browse through each step of this instruction manual prior to beginning the installation to determine if you should refer the job to a professional installer/technician. Please contact your dealer or Vortech Engineering for possible installers in your area.
2. This product was designed for use on stock (un-modified, OEM) vehicles. The PCM (computer), engine, transmission, drive axle ratios and tire O.D. must be stock. If the vehicle or engine has been modified in any way, check with Vortech prior to installation and use of this product.
3. Use only premium grade fuel with a minimum of 91 octane (*R+M/2*).
4. Always listen for any sign of detonation (*knocking/pinging*) and discontinue hard use (*no boost*) until problem is resolved.
5. Vortech is not responsible for any clutch, transmission, drive-line or engine damage.

Exclusions from Vortech warranty coverage considerations include, but not limited to:

1. Neglect, abuse, lack of maintenance, abnormal operation or improper installation.
2. Continued operation with an impaired vehicle or sub-system.
3. The combined use of Vortech components with other modifications such as, but not limited to, exhaust headers, aftermarket camshafts, nitrous oxide, third party PCM programming or other such changes.

©2019 VORTECH ENGINEERING, INC

All rights reserved. No part of this publication may be reproduced, transmitted, transcribed, or translated into another language in any form, by any means without written permission of Vortech Engineering, Inc.

TABLE OF CONTENTS

FOREWORD	<i>ii</i>
TABLE OF CONTENTS	<i>iii</i>
IMPORTANT NOTES	<i>iv</i>
TOOL & SUPPLY REQUIREMENTS	<i>v</i>
PARTS LIST	<i>vi</i>
1. ECU REMOVAL	1
2. BASIC COMPONENT REMOVAL	5
3. HARMONIC DAMPER DOWEL PIN INSTALLATION	15
4. FAN SHROUD & LOWER RADIATOR MOUNT MODIFICATION	19
5. ENGINE COOLING SYSTEM MODIFICATION	23
6. S/C MOUNTING BRACKET ASSEMBLY INSTALLATION	27
7. DISCHARGE ASSEMBLY & HEAT EXCHANGER INSTALLATION	31
8. AIR INLET ASSEMBLY, BYPASS VALVE SIGNAL HOSE & S/C INSTALLATION	43
9. AIR-TO-WATER COOLING SYSTEM INSTALLATION	47
10. RADIATOR FAN SHROUD MODIFICATION & INSTALLATION	57
11. FUEL INJECTOR & MAP SENSOR REPLACEMENT (COMPLETE KIT ONLY)	59
12. FUEL PUMP BOOSTER INSTALLATION (COMPLETE KIT ONLY)	63
13. MISC. REASSEMBLY	69
14. PROGRAMMING CABLE INSTALLATION (2018-2019 VEHICLES ONLY)	71
15. REFLASH COMPUTER (COMPLETE KIT ONLY)	73
16. FINAL CHECK	75
APPENDIX A - DIAGRAM, ASSEMBLY, SUPERCHARGER MOUNTING BRACKET	76
APPENDIX B - DIAGRAM, BELT ROUTING	77
APPENDIX C - DIAGRAM, AIR-TO-WATER COOLING SYSTEM	78
APPENDIX D - DIAGRAM, DISCHARGE TUBE ASSEMBLY	79

NOTICE

This product is protected by state common law, copyright and/or patent. All legal rights therein are reserved. The design, layout, dimensions, geometry, and engineering features shown in this product are the exclusive property of Vortech Engineering, Inc. This product may not be copied or duplicated in whole or part, abstractly or fundamentally, intentionally or fortuitously, nor shall any design, dimension, or other information be incorporated into any product or apparatus without prior written consent of Vortech Engineering, Inc.

2015-2019 Dodge Challenger 6.4L Installation Instructions

Congratulations on selecting the best performing and best backed automotive supercharger available today... the VORTECH® supercharger!

Before beginning this installation, please read through this entire instruction booklet and the Street Supercharger System Owner's Manual which includes the Limited Warranty Program, the Warranty Registration form and return envelope.

Vortech supercharger systems are performance improving devices. In most cases, increases in torque of 30-35% and horsepower between 35-45% can be expected with the boost levels specified by Vortech Engineering. This product is intended for use on healthy, well maintained engines. Installation on a worn-out or damaged engine is not recommended and may result in failure of the engine as well as the supercharger. Vortech Engineering is not responsible for engine damage.

Installation on new vehicles will not harm or adversely affect the break-in period so long as factory break-in procedures are followed.

For best performance and continued durability, please take note of the following key points:

1. Use only premium grade fuel 91 octane or higher (R+M/2).
2. The engine must have stock compression ratio.
3. If the engine has been modified in any way, check with Vortech prior to using this product.
4. Always listen for any sign of detonation (pinging) and discontinue hard use (no boost) until problem is resolved.
5. **Oil Fed Units** - Perform an oil and filter change upon completion of this installation and prior to test driving your vehicle. Thereafter, always use a high grade SF rated engine oil or a high quality synthetic, and change the oil and filter at least every 3,000 miles. Never attempt to extend the oil change interval beyond 3,000 miles, regardless of oil manufacturer's claims as potential damage to the supercharger may result.
6. Before beginning installation, replace all spark plugs that are older than 1-year or 15,000 miles with original heat range plugs as specified by the manufacturer and reset timing to factory specifications (follow the procedures indicated within the factory repair manual and/or as indicated on the factory underhood emissions tag). Do not use platinum spark plugs unless they are original equipment. Change spark plugs every 15,000 miles.

TOOL & SUPPLY REQUIREMENTS

- 1/4" drive & 3/8" drive ratchet and drive set: SAE & metric
- 1/4" drive & 3/8" drive ratchet extensions
- Open end wrenches: SAE & metric
- Torque wrench
- Screwdriver set
- Hose cutters
- Drill motor & 1/4" drill bit
- Wire strippers & crimpers
- Utility knife
- Blue and red threadlocker
- Pipe sealant

If it has been 15,000 miles or more since your vehicle's last spark plug change, then you will also need:

- Spark plug socket
- NEW spark plugs

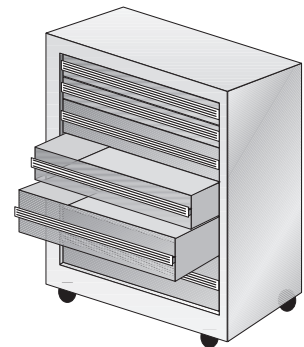



2015-2019 Dodge Challenger 6.4L

Complete Kit Part No. 4CM218-010L

PARTS LIST

IMPORTANT: Before beginning installation, verify that all parts are included in the kit. Report any shortages or damaged parts immediately.

PART NO.	DESCRIPTION	QTY.	PART NUMBER	DESCRIPTION	QTY.
008110	SMALL SILVER DIE CUT DECAL	2	7U038-000	3/4" HEATER HOSE	1.5FT
008130	LICENSE PLATE FRAME, VORTECH	1	7U038-000	3/4" HEATER HOSE	4FT
008447	1 YR S/C STRT INFO PKG ASY VORT1		7U038-012	HOSE, 3/4 DIA 90 , 4" X 12" LEGS	1
009035	S/C LUBE, BOTTLED, 3-PACK	1	7U038-150	HOSE, 3/4 D X 150 MOLDED HOSE	2
2A046-988	BELT, K060988, GATES	1	7U041-000	1/2" HEATER HOSE	2.5FT
2F329-170	V3 S/C ASY, 15-19 HEMI	1	7U100-027	RIVET, PLASTIC, HEMI BMPR CVR	6
4CL110-110	ASY, DAMPER PIN, HEMI	1	7U100-055	TIE WRAP, 7.5" NYLON	10
4GR010-110	GUIDE, DWL PIN IST, C5	1	7U100-102	BUMPER, RUBBER, 1/4" HOLE, 1/8"	3
7C014-095	M14-1.5 X 95 MM SHCS, PLATED	1	7U133-500	1/2 X 90 MOLDED RUBBER HOSE	1
7U250-019	DOWEL PIN, 1/4D X 1/2L	1	4CM212-010	DISCH ASY, 15-19 CHAL 6.4L	1
7U250-026	DRILL BUSHING, 1/4ID, .375OD	1	2A017-094	SPACER, .380L, .313ID, .600D	2
4CM020-010	INSTR MAN, 15-19 CHAL 6.4L	1	4CM012-010	DISCH TUBE A, 15-17 CHALL	1
4CM110-044	MNTG BRKT ASY, 15-19 HEMI	1	4CM012-030	DISCH SLEEVE C, 15-17 HEMI	1
2A017-016	PILOT, 6203/5 BRG, M10 3/8 SCREW	1	4CM012-050	DISCH SLEEVE E, 15-17 HEMI 6.4L	1
2A040-021	RETAINER, PULLEY, FLATHD	1	4CM112-020	ASY, DISCH TUBE B, 15-17 CHALL	1
2A040-051	PLY RETAINER, TAMPER PRF CAP	1	4CM112-040	ASY, DISCH TUBE D, 15-17 HEMI	1
2A040-061	RETAINER CUP, VORT S/C PLY	1	7A250-074	1/4-20 X .75 HHCS PLTD	2
2A042-080	BELT, GATES 20MM, 80T COG	1	7C060-030	M6 X 1.0 X 30MM, FLG HD, PLATED	2
2D170-171	ASSY, JACKSHAFT, SHORT	1	7F250-021	1/4-20 NYLOCK NUT ZINC PLATED	2
4CL116-350	IDLR ASSY, 3.5" DIA 20MM COG, SRT8	1	7J250-001	1/4 WASHER, SAE, PLTD	4
4CM010-020	S/C MNTG PLT A, 15-17 HEMI CAR	1	7P375-250	3/8 X 3/8 X 1/4 MALE BARB TEE	1
4CM010-044	S/C MNTG PLT B, 15-17 HEMI CAR	1	7PS300-275	REDUCER, BLK 3.0- 2.75	1
4CM010-050	PULLEY GUARD, 15-17 HEMI CAR	1	7PS300-300	SLEEVE, BLACK, 3.00D X 3.00	1
4CM036-360	S/C PULLEY 3.60" 6 GROOVE	1	7PS300-301	BUMP HOSE, 3.00D X 3.00L	1
4CM100-001	HARDWARE ASSY, S/C MNTG BRKT	1	7R002-044	#44 SAE TYPE F SS HOSE CLAMP	2
4CM100-002	SPACER ASSY, S/C MNTG BRKT	1	7R002-048	#48 SAE TYPE F SS HOSE CLAMP	7
4FH016-150	IDLER PLY, SMOOTH 6RIB 3" FLANGD	1	7R002-056	#56 SAE TYPE F SS HOSE CLAMP	1
4GR032-032	PLY, JACKSHAFT, C5, 20MM, 32T	1	7R004-007	STEPLESS CLAMP, 28.6	1
4CM112-030	AIR INLET ASSY, 15-19 HEMI	1	7U030-218	7/32 VAC HOSE, BUNA-N	5
7P500-009	1/2" X 90 HOSE BARB UNION	1	5A002-071	MAP SENSOR, 3-BAR, SRT-4	1
7P750-502	REDUCER, 3/4" TO 1/2" COUPLER	1	5A003-160	PROG, LIVERNOIS, MYCAL TOUCH	1
7U030-036	1/2" OIL DRAIN HOSE	2.5FT	5A102-040	ASY, VOLT BST, PNP, 15-19 HEMI	1
8H040-240	AIR FILTER, 15-17 HEMI CAR	1	8D204-113	ASSY, BILLET BYPASS VALVE	1
4CM155-020	SPRT ITMS, CAC SYS, 15-19 CHAL	1	8F060-006	FUEL INJECTOR, HELLCAT	8
4CM010-060	BRKT, RAD SHROUD, 1.00", CHALL	1	8N006-026	HEAT EXCHANGER, CAC SYS	1
4CM010-070	BRKT, RAD SHROUD, .750", CHALL	2	8N107-200	ASY, W/P MNTG, 15-19 HEMI	1
4CM011-012	BRKT, HEAT EXCHANGER, P. SIDE	1	5W001-141	HARNES, AUX W/P, 15-17 HEMI CAR	1
4CM011-013	BRKT, HEAT EXCHANGER, D. SIDE	1	7A250-075	1/4-20 X .75 SHCS PLTD	1
4CM011-014	BRKT, CAC RESERVOIR, 15-17 HEMI	1	7F250-021	1/4-20 NYLOCK NUT ZINC PLATED	1
4CM011-015	BRKT, CAC, D. SIDE, 15-17 HEMI	1	7R003-029	ADEL CLAMP, 1-5/8" ID	1
4CM011-016	BRKT, CAC, P. SIDE, 15-17 CHALL	1	8F001-405	BOSCH AUX WATER PUMP	1
4CM011-017	BRKT, CAC, TOP SIDE, 15-17 CHALL	1	8N201-400	ASY, CAC, SAT, 15-19 HEMI	1
4CM011-018	HORN BRKT, 15-17 HEMI CAR	1			
4CM055-020	RESERVOIR, CAC, 15-17 HEMI	1			
5W001-082	SLEEVE, FLEX BRAID .75" NOM.	8FT			
7A250-050	1/4-20 X .50 SHCS GR8 ZINC PLTD	8			
7A250-051	1/4-20 X .50 HHCS GR5 ZINC PLTD	1			
7A250-075	1/4-20 X .75 SHCS PLTD	2			
7A250-500	1/4-20 X 5 SHCS	4			
7C060-011	M6 X 1.0 X 10 HXHD CL8.8 PLT	1			
7C080-012	M8 X 1.25 X 12MM LOW SHCS	1			
7F006-093	NUT, M6 X 1.0, NYLOCK, PLATED	2			
7F250-021	1/4-20 NYLOCK NUT ZINC PLATED	4			
7J250-001	1/4 WASHER, SAE, PLTD	12			
7J312-000	5/16 FLAT WASHER-SAE	1			
7P375-075	3/4" HOSE BARB UNION, BRASS	1			
7P500-035	FITTING, 1/2 NPT X 3/4 BARB X 45	1			
7P500-078	1/2NPT X 3/4 HOSE FIT STRT	1			
7P750-502	REDUCER, 3/4" TO 1/2" COUPLER	1			
7P750-503	3/4-1/2 REDUCER BARB 90	1			
7R001-006	#6 STNLS HOSE CLAMP, NARROW	4			
7R002-010	#10 SAE TYPE F SS HOSE CLAMP	8			
7R004-007	STEPLESS CLAMP, 28.6	2			
7T100-281	9/32" X 6" LENGTH EXTENDED DRILL	1			
7U030-065	HOSE, 3/4 X 90 ELBOW, SHORT	1			



2015-2019 Dodge Challenger 6.4L

Tuner Kit Part No. 4CM218-110L

PARTS LIST

IMPORTANT: Before beginning installation, verify that all parts are included in the kit. Report any shortages or damaged parts immediately.

PART NO.	DESCRIPTION	QTY.	PART NUMBER	DESCRIPTION	QTY.
008110	SMALL SILVER DIE CUT DECAL	2	7U038-000	3/4" HEATER HOSE	1.5FT
008130	LICENSE PLATE FRAME, VORTECH	1	7U038-000	3/4" HEATER HOSE	4FT
008447	1 YR S/C STRT INFO PKG ASY VORT1		7U038-012	HOSE, 3/4 DIA 90 , 4" X 12" LEGS	1
009035	S/C LUBE, BOTTLED, 3-PACK	1	7U038-150	HOSE, 3/4 D X 150 MOLDED HOSE	2
2A046-988	BELT, K060988, GATES	1	7U041-000	1/2" HEATER HOSE	2.5FT
2F329-170	V3 S/C ASY, 15-19 HEMI	1	7U100-027	RIVET, PLASTIC, HEMI BMPR CVR	6
4CL110-110	ASY, DAMPER PIN, HEMI	1	7U100-055	TIE WRAP, 7.5" NYLON	10
4GR010-110	GUIDE, DWL PIN IST, C5	1	7U100-102	BUMPER, RUBBER, 1/4" HOLE, 1/8"	3
7C014-095	M14-1.5 X 95 MM SHCS, PLATED	1	7U133-500	1/2 X 90 MOLDED RUBBER HOSE	1
7U250-019	DOWEL PIN, 1/4D X 1/2L	1	4CM212-010	DISCH ASY, 15-19 CHAL 6.4L	1
7U250-026	DRILL BUSHING, 1/4ID, .375OD	1	2A017-094	SPACER, .380L, .313ID, .600D	2
4CM020-010	INSTR MAN, 15-19 CHALL 6.4L	1	4CM012-010	DISCH TUBE A, 15-17 CHALL	1
4CM110-044	MNTG BRKT ASY, 15-19 HEMI	1	4CM012-030	DISCH SLEEVE C, 15-17 HEMI	1
2A017-016	PILOT, 6203/5 BRG, M10 3/8 SCREW	1	4CM012-050	DISCH SLEEVE E, 15-17 HEMI 6.4L	1
2A040-021	RETAINER, PULLEY, FLATHD	1	4CM112-020	ASY, DISCH TUBE B, 15-17 CHALL	1
2A040-051	PLY RETAINER, TAMPER PRF CAP	1	4CM112-040	ASY, DISCH TUBE D, 15-17 HEMI	1
2A040-061	RETAINER CUP, VORT S/C PLY	1	7A250-074	1/4-20 X .75 HHCS PLTD	2
2A042-080	BELT, GATES 20MM, 80T COG	1	7C060-030	M6 X 1.0 X 30MM, FLG HD, PLATED	2
2D170-171	ASSY, JACKSHAFT, SHORT	1	7F250-021	1/4-20 NYLOCK NUT ZINC PLATED	2
4CL116-350	IDLR ASSY, 3.5" DIA 20MM COG, SRT8	1	7J250-001	1/4 WASHER, SAE, PLTD	4
4CM010-020	S/C MNTG PLT A, 15-17 HEMI CAR	1	7P375-250	3/8 X 3/8 X 1/4 MALE BARB TEE	1
4CM010-044	S/C MNTG PLT B, 15-17 HEMI CAR	1	7PS300-275	REDUCER, BLK 3.0- 2.75	1
4CM010-050	PULLEY GUARD, 15-17 HEMI CAR	1	7PS300-300	SLEEVE, BLACK, 3.00D X 3.00	1
4CM036-360	S/C PULLEY 3.60" 6 GROOVE	1	7PS300-301	BUMP HOSE, 3.00D X 3.00L	1
4CM100-001	HARDWARE ASSY, S/C MNTG BRKT	1	7R002-044	#44 SAE TYPE F SS HOSE CLAMP	2
4CM100-002	SPACER ASSY, S/C MNTG BRKT	1	7R002-048	#48 SAE TYPE F SS HOSE CLAMP	7
4FH016-150	IDLER PLY, SMOOTH 6RIB 3" FLANGD	1	7R002-056	#56 SAE TYPE F SS HOSE CLAMP	1
4GR032-032	PLY, JACKSHAFT, C5, 20MM, 32T	1	7R004-007	STEPLESS CLAMP, 28.6	1
4CM112-030	AIR INLET ASSY, 15-19 HEMI	1	7U030-218	7/32 VAC HOSE, BUNA-N	5
7P500-009	1/2" X 90 HOSE BARB UNION	1	8D204-113	ASSY, BILLET BYPASS VALVE	1
7P750-502	REDUCER, 3/4" TO 1/2" COUPLER	1	8N006-026	HEAT EXCHANGER, CAC SYS	1
7U030-036	1/2" OIL DRAIN HOSE	2.5FT	8N107-200	ASY, W/P MNTG, 15-19 HEMI	1
8H040-240	AIR FILTER, 15-17 HEMI CAR	1	5W001-141	HARNASS, AUX W/P, 15-17 HEMI CAR	1
4CM155-020	SPRT ITMS, CAC SYS, 15-19 CHAL 1	1	7A250-075	1/4-20 X .75 SHCS PLTD	1
4CM010-060	BRKT, RAD SHROUD, 1.00", CHALL	1	7F250-021	1/4-20 NYLOCK NUT ZINC PLATED	1
4CM010-070	BRKT, RAD SHROUD, .750", CHALL	2	7R003-029	ADEL CLAMP, 1-5/8" ID	1
4CM011-012	BRKT, HEAT EXCHANGER, P. SIDE	1	8F001-405	BOSCH AUX WATER PUMP	1
4CM011-013	BRKT, HEAT EXCHANGER, D. SIDE	1	8N201-400	ASY, CAC, SAT, 15-19 HEMI	1
4CM011-014	BRKT, CAC RESERVOIR, 15-17 HEMI	1			
4CM011-015	BRKT, CAC, D. SIDE, 15-17 HEMI	1			
4CM011-016	BRKT, CAC, P. SIDE, 15-17 CHALL	1			
4CM011-017	BRKT, CAC, TOP SIDE, 15-17 CHALL	1			
4CM011-018	HORN BRKT, 15-17 HEMI CAR	1			
4CM055-020	RESERVOIR, CAC, 15-17 HEMI	1			
5W001-082	SLEEVE, FLEX BRAID .75" NOM.	8FT			
7A250-050	1/4-20 X .50 SHCS GR8 ZINC PLTD	8			
7A250-051	1/4-20 X .50 HHCS GR5 ZINC PLTD	1			
7A250-075	1/4-20 X .75 SHCS PLTD	2			
7A250-500	1/4-20 X 5 SHCS	4			
7C060-011	M6 X 1.0 X 10 HXHD CL8.8 PLT	1			
7C080-012	M8 X 1.25 X 12MM LOW SHCS	1			
7F006-093	NUT, M6 X 1.0, NYLOCK, PLATED	2			
7F250-021	1/4-20 NYLOCK NUT ZINC PLATED	4			
7J250-001	1/4 WASHER, SAE, PLTD	12			
7J312-000	5/16 FLAT WASHER-SAE	1			
7P375-075	3/4" HOSE BARB UNION, BRASS	1			
7P500-035	FITTING, 1/2 NPT X 3/4 BARB X 45	1			
7P500-078	1/2NPT X 3/4 HOSE FIT STRT	1			
7P750-502	REDUCER, 3/4" TO 1/2" COUPLER	1			
7P750-503	3/4-1/2 REDUCER BARB 90	1			
7R001-006	#6 STNLS HOSE CLAMP, NARROW	4			
7R002-010	#10 SAE TYPE F SS HOSE CLAMP	8			
7R004-007	STEPLESS CLAMP, 28.6	2			
7T100-281	9/32" X 6" LENGTH EXTENDED DRILL	1			
7U030-065	HOSE, 3/4 X 90 ELBOW, SHORT	1			



!!BEFORE YOU BEGIN!!



In order to be able to load the Vortech tune your vehicle, the ECU will need to be sent to Livernois Motorsports for it to be unlocked. We **HIGHLY** recommend sending the ECU to be unlocked **BEFORE** you begin the installation of your supercharger kit, as it may take some time for your ECU to be returned to you. While you wait for your ECU to return, you may begin the installation of your supercharger kit.

An **ECU Unlock Voucher**, shipping box, and prepaid shipping label is included with **Complete Kits ONLY**. Additionally, 2018-2019 model-year vehicles require a **Programming Cable** from Livernois Motorsports in order to properly load the Vortech tune to your vehicle. The **Programming Cable** will be included when your ECU is returned to you.

NOTICE: TUNER KITS - You are responsible for purchasing the ECU unlock service and Programming Cable (2018-2019 model-year vehicles) directly from Livernois Motorsports. Purchasing these parts from Livernois Motorsports **DOES NOT** entitle you the Vortech tune, as the tune is provided **ONLY** to customers who have purchased a Complete Kit and have a valid ECU Unlock Voucher, which is **NOT** sold separately.

1. ECU REMOVAL

- A. Open the trunk and lift the carpet. Remove the positive battery terminal cover from the battery, then proceed to unplug both battery leads.

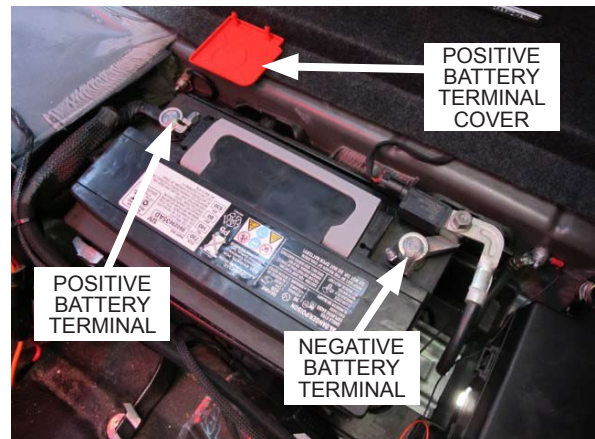

Fig. 1-a: Unplug battery

- B. There are six plastic fasteners that secure the windshield cowl to the cross bar. Using a panel removal tool, remove the six plastic fasteners and set them aside.



Fig. 1-b: Remove plastic fasteners

- C. On the driver side of the engine compartment, near the bottom of the windshield cowl, are two screws that secure the cross bar. Using a 13mm socket, remove the two screws and set them aside.



Fig. 1-c: Remove cross bar screws

1. ECU REMOVAL

- D. On the passenger side of the engine compartment near the windshield cowl is the ECU cover. Using a panel removal tool, remove the two plastic fasteners securing the ECU cover. Set the ECU cover and two plastic fasteners aside.



Fig. 1-d: Remove two plastic fasteners

- E. There are two nuts securing the ECU to its mounting bracket. Using a 10mm wrench, remove the ECU nuts and set them aside. You will notice that the ECU mounting bracket is attached to the cross bar. Using a 13mm socket, remove the two screws securing the cross bar to the vehicle, then proceed to remove the ECU mounting bracket and set it aside, but leave the ECU in the vehicle.

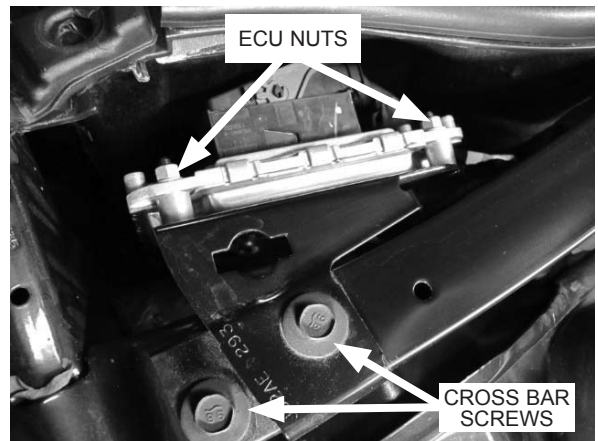

Fig. 1-e: Remove ECU nuts and remove cross bar screws

- F. If you look on the underside of the cross bar, you will notice that the windshield wiper motor is mounted to it using a rubber mount. Now that the cross bar is loose, proceed to remove the cross bar from the vehicle, making sure to remove the windshield wiper motor mount from the underside of the cross bar.

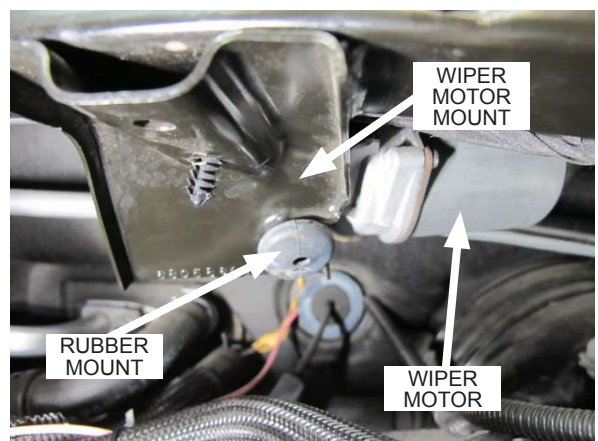

Fig. 1-f: Windshield wiper motor mount

1. ECU REMOVAL

- G. Now that the cross bar is removed, proceed to disconnect both ECU connectors and remove the ECU from the vehicle.

NOTE: In order to be able to tune the vehicle, the ECU will need to be removed and sent out to be unlocked by Livernois Motorsports.



Fig. 1-g: Disconnect ECU

- H. Locate the provided ECU Unlock Voucher and fill it out with the requested information. Be sure not to lose this document. Locate the provided shipping box and pre-paid shipping label. Fill out the shipping label with your return address. Use the paper packaging material to protect the ECU, then place it into the box. Place the ECU Unlock Voucher in the box as well, then tape it shut. Place the shipping label on the box, fill in the return address, then mail the package to Livernois Motorsports.

NOTE: Complete kits only. Tuner kits, proceed to Section 2.

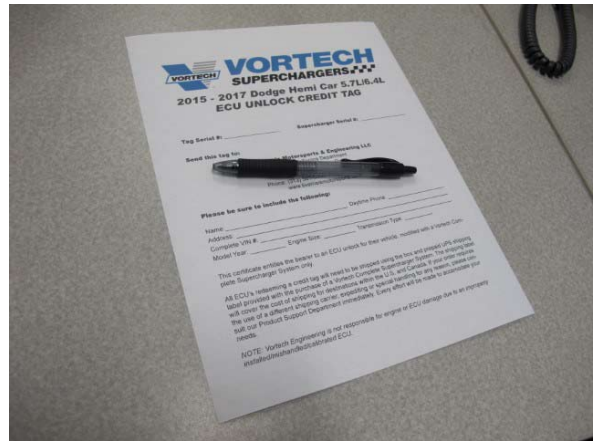

Fig. 1-h: ECU Unlock Voucher

This page was left intentionally blank.

2. BASIC COMPONENT REMOVAL

- A. Remove the two plastic covers from the top of the front bumper cover by pulling them apart at the center, then set them aside.

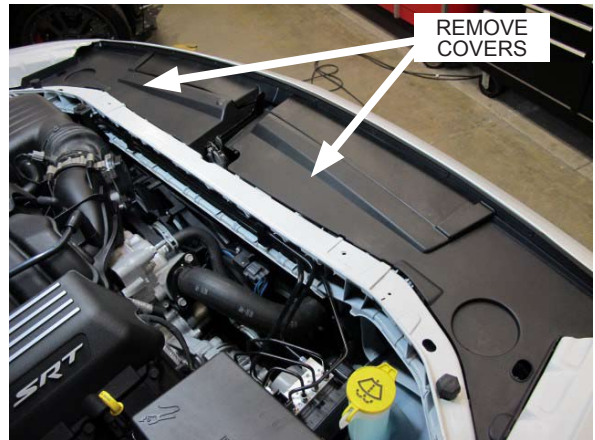

Fig. 2-a: Remove covers

- B. Using a panel removal tool, remove the six plastic fasteners securing the top of the radiator shroud to the vehicle and set aside.



Fig. 2-b: Remove six plastic fasteners

- C. Using a drill motor and an 1/8" drill bit, drill through the center of the plastic rivets securing the fender liner to the front bumper cover. New plastic rivets are provided with this kit. Do this for both sides of the vehicle.



Fig. 2-c: Drill through and remove plastic rivets

2. BASIC COMPONENT REMOVAL

- D. On each side of the vehicle are two plastic fasteners securing the engine service panel to the inner fender liner. Using a panel removal tool, remove these fasteners and set them aside.



Fig. 2-d: Remove two plastic fasteners

- E. Using a panel removal tool, remove the three plastic fasteners securing the front bumper cover to the vehicle and set aside. Next, using a 10mm socket, remove the four screws securing the engine service panel to the vehicle and set aside.



Fig. 2-e: Remove splash guard

- F. Located on each of the top corners of the front bumper cover is a threaded stud that is used to secure the front bumper cover to the fenders using a nut. Using a 10mm socket, remove these nuts and set aside.



Fig. 2-f: Remove two nuts

2. BASIC COMPONENT REMOVAL

- G. There is one screw on each outer edge of the front bumper cover, beneath the fender liner. Pull back the fender liner and using a 10mm socket, remove these screws and set them aside.



Fig. 2-g: Remove screw

- H. On each side of the front bumper cover is another threaded stud that secures the front bumper cover to the fenders using a nut. To gain access to this nut, we suggest pulling back the fender liner, using a long extension, a deep 10mm socket and ratchet to reach this screw. Using the proper tools, remove the nut.



Fig. 2-h: Remove two nuts
(Bumper removed for clarity)

- I. Located on the passenger side behind the front bumper cover is the connector for the fog lights that's mounted to a plastic bracket. Disconnect the fog light connector. Detach the connector from the plastic mounting bracket, then remove the plastic mounting bracket from the vehicle. It will not be reused.

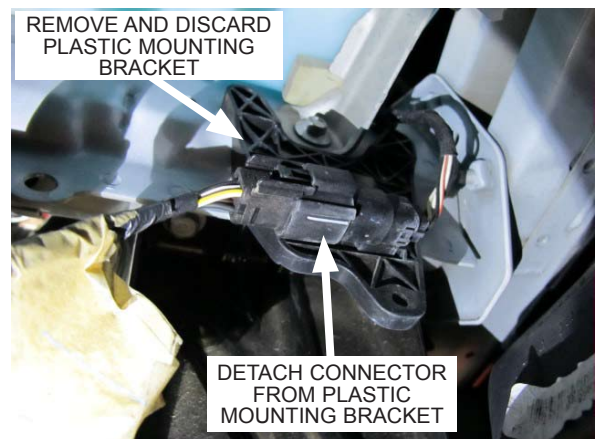

Fig. 2-i: Disconnect fog light connector

2. BASIC COMPONENT REMOVAL

- J. The corners of the front bumper cover typically snap into place on the front fenders. In order to release the front bumper cover from the front fenders, you will need to pull the edges of the front bumper cover away from the fenders with a good amount of force, making sure you have a good grip on the front bumper cover as to not cause any damage. Once released, proceed to remove the front bumper cover from the vehicle and set aside.



Fig. 2-j: Remove front bumper cover

- K. Remove the plastic fasteners securing the plastic bumper guard to the front bumper beam. Remove the bumper guard and set aside.



Fig. 2-k: Remove plastic bumper guard

- L. Remove the ambient air temperature sensor from the radiator shroud and set aside. It will be relocated in a later step.

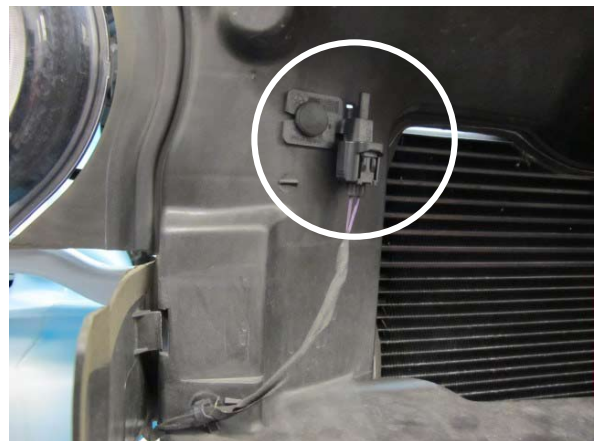

Fig. 2-l: Remove ambient air temperature sensor

2. BASIC COMPONENT REMOVAL

- M. Using a panel removal tool, remove the four plastic fasteners securing the top section of the radiator shroud to the vehicle and set aside.



Fig. 2-m: Remove radiator shroud and fasteners

- N. **Vehicles with Shaker hood:** Located just behind the weather stripping on each corner of the shaker scoop are four nuts. Using a 10mm socket, remove the four nuts securing the shaker scoop to the shaker base.



Fig. 2-n: Remove shaker scoop

- O. **Vehicles with Shaker hood:** Using a flathead screw driver, loosen the air inlet hose clamp on the underside of the shaker base.

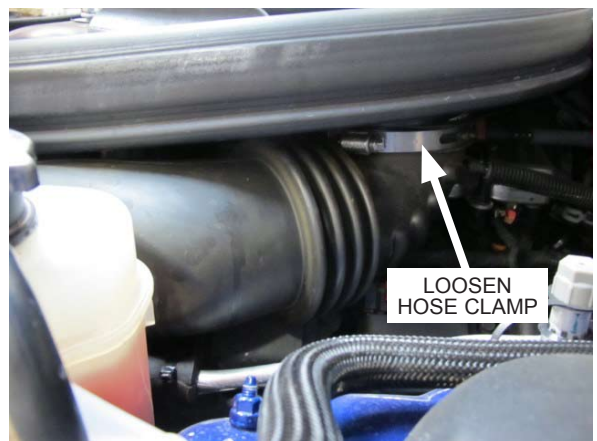

Fig. 2-o: Loosen hose clamp

2. BASIC COMPONENT REMOVAL

- P. **Vehicles with Shaker hood:** Using a 10mm socket, remove the five fasteners securing the shaker base to its mounting bracket on the engine, then remove the shaker base from the vehicle. Using a 10mm socket, remove the screw securing the air filter enclosure to the vehicle. Disconnect the IAT sensor, detach the breather hose from the engine, loosen the hose clamp securing the air inlet to the throttle body, then remove the entire air inlet assembly from the vehicle. It will not be reused.



Fig. 2-p: Remove shaker base

- Q. **Vehicles without Shaker hood:** Using a 10mm socket, remove the screw securing the airbox to the vehicle. Detach the breather hose from the airbox, disconnect the IAT sensor and loosen the hose clamp securing the air inlet duct to the throttle body. Remove the airbox and air inlet duct from the vehicle as they will not be reused. Set the breather hose aside as it will be reused in a later step.

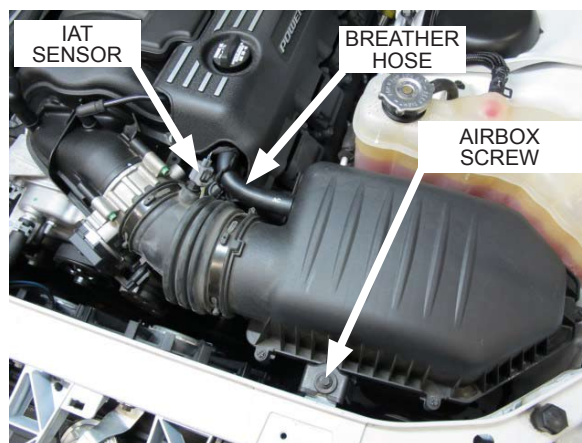

Fig. 2-q: Remove airbox and air inlet duct

- R. In order to make more working space when pinning the crankshaft in a later step, it will be necessary to remove the radiator fan assembly. There is one screw on each side of the radiator fan assembly. Using a 10mm socket, remove the screws and set aside.



Fig. 2-r: Remove radiator fan assembly

2. BASIC COMPONENT REMOVAL

- S. Locate the coolant drain valve on the bottom of the radiator on the passenger side. Open the drain valve and drain the engine coolant into a clean container. The engine coolant will drain from the factory-installed engine coolant drain hose.

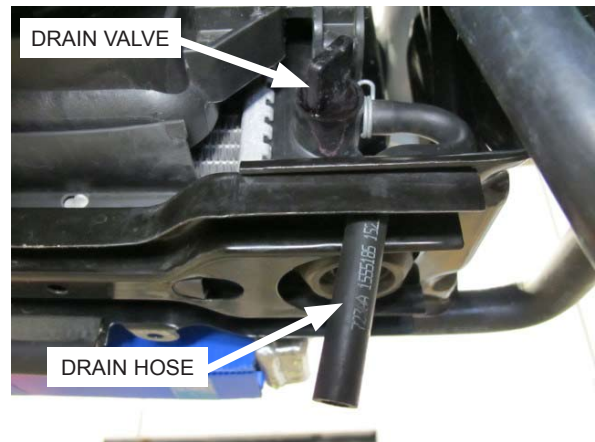

Fig. 2-s: Drain coolant

- T. There is a small coolant hose that is attached to the radiator fan assembly. Detach this hose from the radiator fan assembly, then proceed to unplug the radiator fan connector.



Fig. 2-t: Detach coolant hose and unplug radiator fan connector

- U. The radiator rests on the lower radiator support. Since the lower radiator support will be removed in the next step, it will be necessary to secure the radiator to the vehicle. Using zip ties, pass them through the holes on the upper part of the radiator, near the upper radiator alignment brackets, and wrap the zip tie around the core support. Repeat this step for both sides of the radiator.

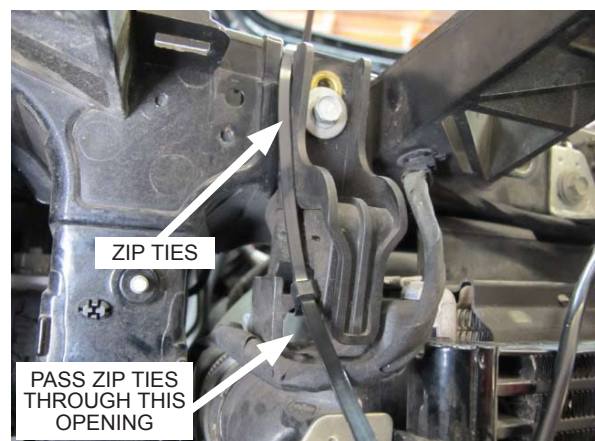

Fig. 2-u: Zip tie radiator to core support

2. BASIC COMPONENT REMOVAL

- V. The A/C condenser and radiator fan assembly are attached to the radiator, which is mounted to the lower radiator support. In order to remove the radiator fan assembly from the vehicle, the lower radiator support will need to be removed from the vehicle. Doing this will allow the radiator, A/C condenser, and radiator fan assembly to be lowered and moved forward, away from the engine. Place a floor jack (or a suitable tool) underneath the lower radiator support, then use a 13mm socket and proceed to remove the four screws (two per side) from each side of the lower radiator support. Be sure to remember which side of the lower radiator support is the driver side.

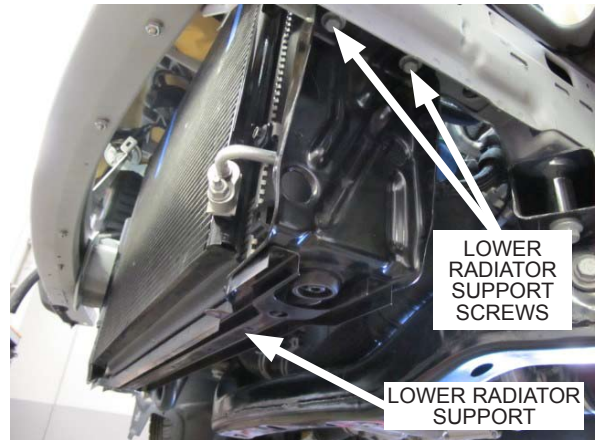

Fig. 2-v: Remove lower radiator support hardware

- W. Now that the lower radiator support is no longer fastened to the vehicle, proceed to lower the lower radiator support away from the vehicle. Once you have enough room, remove the radiator fan assembly from the radiator and set it aside.

NOTE: The A/C lines will remain attached to the A/C condenser. Be sure to avoid damaging the A/C lines during this process.



Fig. 2-w: Remove radiator fan assembly

- X. Use a long 3/8" ratchet or 3/8" breaker bar to rotate the belt tensioner clockwise to release tension from the 6-rib accessory drive belt. Remove the belt as it will not be reused.

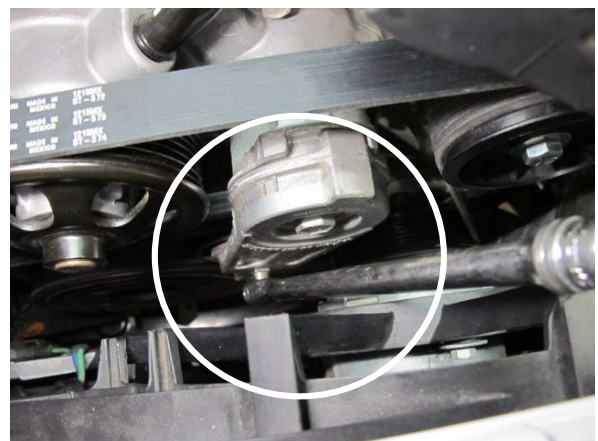

Fig. 2-x: Remove accessory drive belt

2. BASIC COMPONENT REMOVAL

- Y. Located on the driver side cylinder head is an idler pulley mount assembly. Using a 13mm socket, remove the three screws securing the assembly to the driver side cylinder head. The assembly and hardware will not be reused.

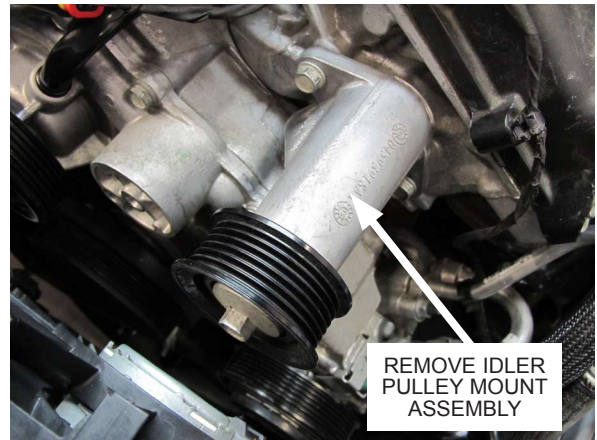

Fig. 2-y: Remove idler pulley mount assembly

This page was left intentionally blank.

3. HARMONIC DAMPER DOWEL PIN INSTALLATION

NOTE: Be sure to avoid damaging the radiator during this section. We suggest temporarily covering the radiator with a piece of cardboard.

- A. Remove the factory crankshaft damper bolt.

NOTE: M/T Vehicles: With the wheels on the ground, place the car in 6th gear and apply the parking brake, then proceed to remove the factory crankshaft damper bolt.

A/T Vehicles: Remove the transmission access panel. To lock the engine in place, use a flywheel / flexplate locking tool or a large pry bar to keep the engine from rotating. See Fig. 3-f & Fig. 3-g.



Fig. 3-a: Remove crankshaft damper bolt

- B. Install the supplied drill guide, making sure that the raised section is used as a pilot inside the damper bore. Secure it in place using the supplied socket head cap screw. Do not over-tighten the screw as it may distort the drill guide.

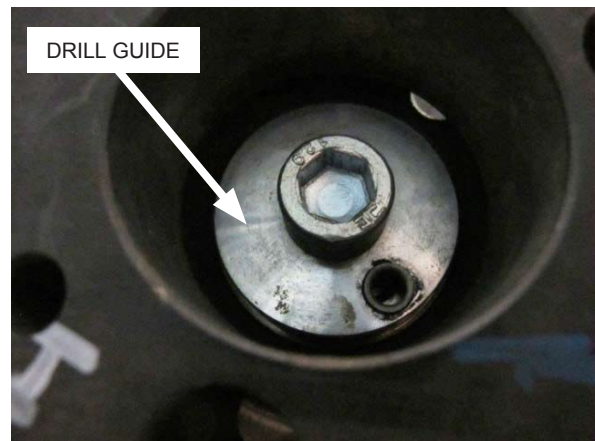

Fig. 3-b: Install drill guide

- C. Using a piece of tape or a drill stop, mark your 1/4" drill bit at a point of 2.60" from the tip of the drill bit.

NOTE: Be sure to use a sharp, high quality 1/4" drill bit for this step.

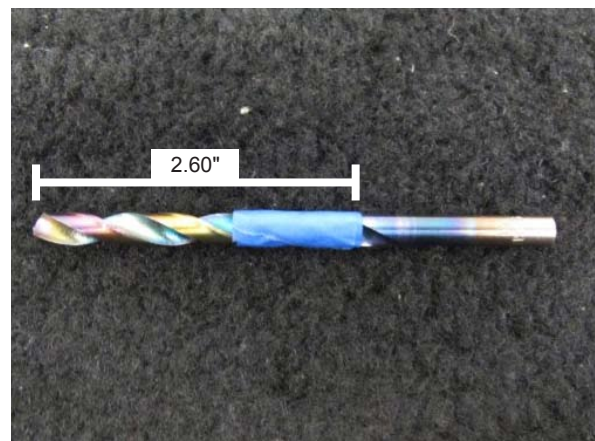

Fig. 3-c: Measure drill bit to 2.60"

3. HARMONIC DAMPER DOWEL PIN INSTALLATION

- D. Using an angle drill or a small drill motor, drill into the crankshaft / damper assembly through the bushing in the drill guide, making sure to keep the tool perpendicular to the damper. Stop when the mark on the drill bit is even with the face of the damper. This will yield a hole depth of 1/2".

NOTE: Periodically stop and allow the drill bit to cool down. Overheating the drill bit may cause it to dull and potentially break. We suggest using cutting oil to ease this step.



Fig. 3-d: Drill crankshaft / damper assembly

- E. Remove the drill guide, then proceed to clean the area/hole of metal chips. Install the supplied dowel pin in the drilled hole, making sure that it doesn't protrude past the damper face.

NOTE: The hole depth should be more than enough to allow the dowel pin to fully seat, however if the dowel pin still protrudes past the damper face, use a small grinding disk to grind down the dowel pin so it parallel with the face of the damper face.



Fig. 3-e: Install dowel pin

- F. Remove the flywheel access panel by removing the screw using a 10mm socket, then pulling the panel away from the transmission.

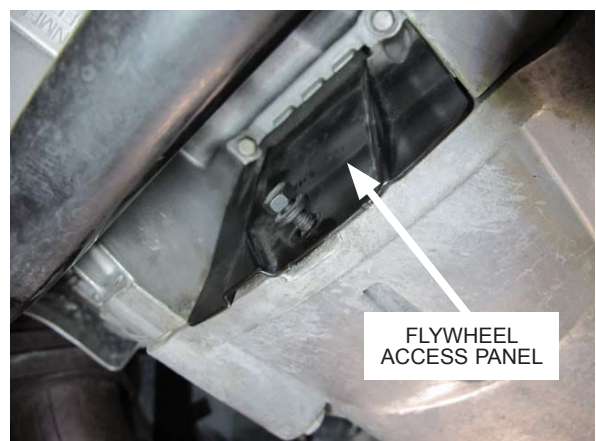

Fig. 3-f: Remove transmission access panel

3. HARMONIC DAMPER DOWEL PIN INSTALLATION

- G. Using a flywheel / flexplate locking tool or a large pry bar, lock the engine in position to keep it from rotating while you torque the crankshaft damper bolt.



Fig. 3-g: Lock engine in position



Use red threadlocker on the crankshaft damper bolt.

- H. With the flywheel / flexplate locked in place, install and tighten the crankshaft damper bolt to 143ft-lbs.

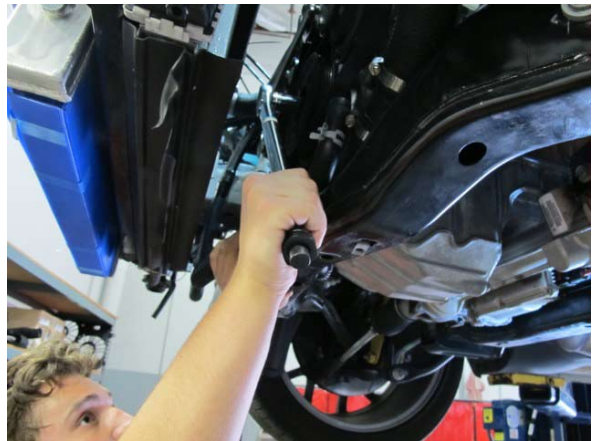

Fig. 3-h: Torque crank bolt

This page was left intentionally blank.

4. FAN SHROUD & LOWER RADIATOR MOUNT MODIFICATION

- A. Using a grinding tool, round off the outer edges of the ribs on the driver side radiator fan shroud. This is in preparation for a later step.

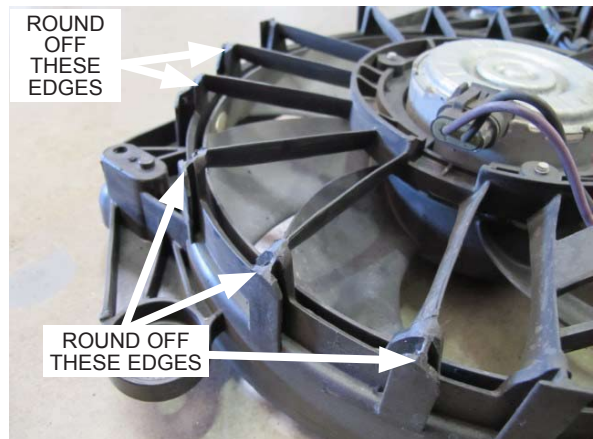

Fig. 4-a: Modify outer edges

- B. Reinstall the radiator fan assembly and verify that the electrical connector is plugged in. Secure using the OEM hardware.



Fig. 4-b: Reinstall radiator fan assembly

- C. Locate the lower radiator support. The driver and passenger side rear edge will need to be modified. Be sure to remember which side of the lower radiator support is the driver side.



Fig. 4-c: Lower radiator support

4. FAN SHROUD & LOWER RADIATOR MOUNT MODIFICATION

- D. Two holes will need to be drilled on the driver side rear edge of the lower radiator mount. From the bottom edge of the lower radiator support, make a line at 3.25".



Fig. 4-d: Measure 3.25" from bottom edge

- E. Measuring from the inside edge of the lower radiator support, measure 1/2" and make a line. This will be the location of the first hole.

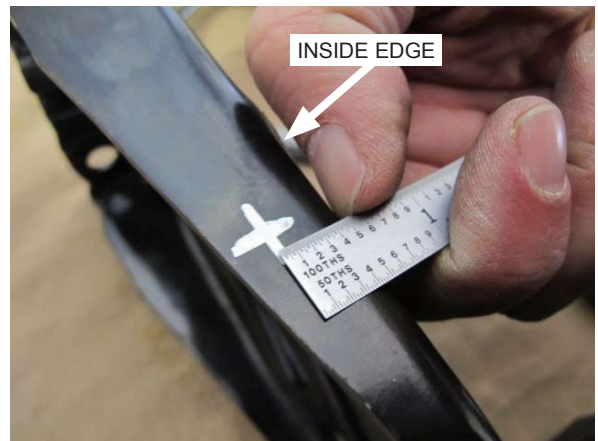

Fig. 4-e: Measure 1/2" from inside edge

- F. Measuring from the first marks, make another line up at 2.00". Lastly, measuring from the inside edge, measure 1/2" and make another line. This will be the location of the second hole.

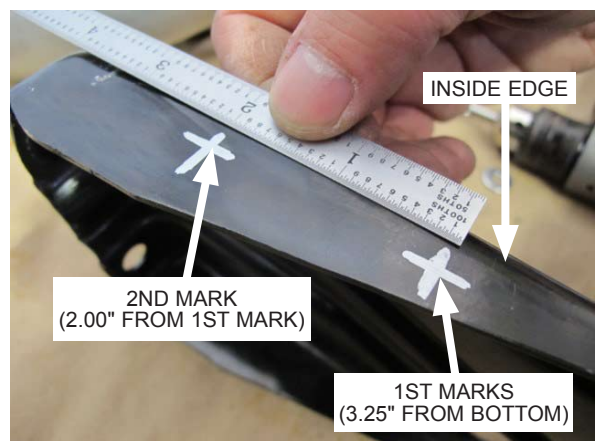

Fig. 4-f: Measure 2.00" up from first marks

4. FAN SHROUD & LOWER RADIATOR MOUNT MODIFICATION

- G. With both hole locations marked on the driver side rear edge of the lower radiator mount, use a 9/32" drill bit to drill through the center of both measurements.



Fig. 4-g: Drill holes on driver side rear edge of lower radiator support

- H. A hole will need to be drilled on the passenger side rear edge of the lower radiator mount. Using the measurements in Fig. 4-j, mark the center of the measurements and use a 9/32" drill bit to drill through the passenger side rear edge of the lower radiator mount.



Fig. 4-h: Drill hole on passenger side rear edge of lower radiator support

- I. After the three holes are drilled and deburred, proceed to reinstall the lower radiator support and secure using the OEM hardware.



Fig. 4-i: Reinstall lower radiator support

4. FAN SHROUD & LOWER RADIATOR MOUNT MODIFICATION

- J. In a later step, discharge tube 'D' and discharge sleeve 'E' will be installed close to the driver side radiator fan shroud. In order to provide space for the discharge tube and the discharge sleeve, you will need to grind the tube profile into some of the ribs on the driver side radiator fan shroud. Be sure not to break through the ribs during grinding. Use Fig. 4-j as an example.

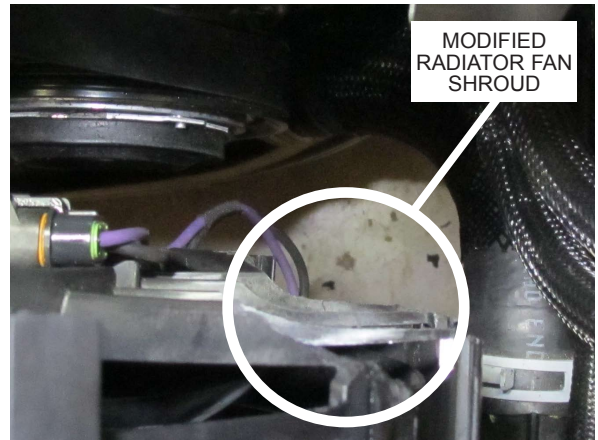

Fig. 4-j: Modified driver side radiator fan shroud

5. ENGINE COOLING SYSTEM MODIFICATION

- A. Using a pair of pliers to remove the spring clamp, remove the coolant reservoir hose that is attached to the bottom side of the coolant reservoir.



Fig. 5-a: Detach coolant reservoir hose from bottom side of coolant reservoir

- B. Down near the K-member you'll see a large diameter coolant hose with a plastic tee with a smaller diameter coolant hose attached to it. The smaller diameter hose is the coolant reservoir hose. Using a pair of pliers to remove the spring clamp, remove the hose from the plastic tee and remove the hose from the vehicle. Keep the two spring clamps and protective cover, but discard the hose as it will not be reused.



Fig. 5-b: Detach coolant reservoir hose from plastic tee

- C. In order to make space for discharge tubes, the plastic tee will need to be rotated 180° clockwise. Use a pair of pliers to temporarily move the two spring clamps as shown.

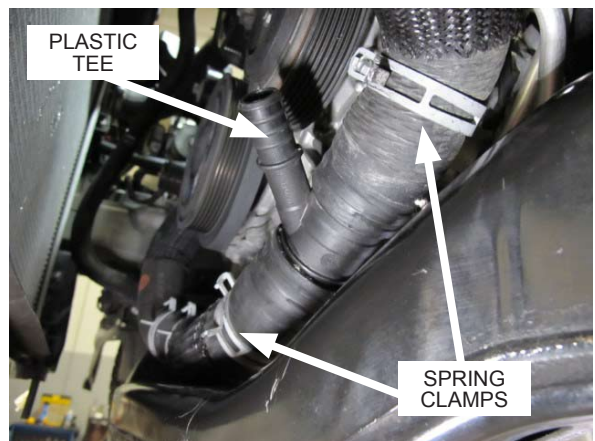

Fig. 5-c: Temporarily move two spring clamps

5. ENGINE COOLING SYSTEM MODIFICATION

- D. Rotate the plastic tee 180° clockwise so the smaller diameter leg is pointed towards the back of the vehicle. Once the tee is rotated, proceed to reinstall the OEM spring clamps.



Fig. 5-d: Rotate plastic tee 180° clockwise

- E. Locate the provided 1.5' length of 3/4" I.D. hose, 3/4" x 90° rubber elbow, brass hose mender, and two 28.6 stepless clamps. Assemble the components as shown and secure the two 28.6 stepless clamps. Slide the OEM protective cover over the hose at this time.

NOTE: One of the legs on the 3/4" x 90° is slightly longer than the other. In this instance, the brass hose mender will be inserted into the shorter leg.



Fig. 5-e: Assemble new coolant reservoir hose as shown

- F. Install the new coolant reservoir hose assembly to the plastic tee, then route the other end of the hose towards the bottom of the coolant reservoir. Reuse the spring clamp to secure the hose to the plastic tee.



Fig. 5-f: Install 90° end of new coolant reservoir hose to plastic tee

5. ENGINE COOLING SYSTEM MODIFICATION

- G. Attach the remaining end of the smaller diameter coolant hose to the bottom of the coolant reservoir. Reuse the spring clamp to secure the hose.



Fig. 5-g: Attach coolant hose to coolant reservoir

- H. Verify that the coolant drain valve is closed, then proceed to refill the engine coolant system. Check for any leaks while you refill the engine coolant system.



Fig. 5-h: Close coolant drain valve and refill engine coolant system

This page was left intentionally blank.

6. S/C MOUNTING BRACKET ASSEMBLY INSTALLATION



Use blue threadlocker on all fasteners in this section.

- A. The supercharger mounting bracket comes preassembled. In order to be able to install the serpentine belt, the pulley guard will need to be removed. Using a 3/16" hex tool, remove the two 1/4"-20 x 1/2" socket head cap screws securing the pulley guard to the supercharger mounting bracket. Set the screws and pulley guard aside. They will be reinstalled in a later step.

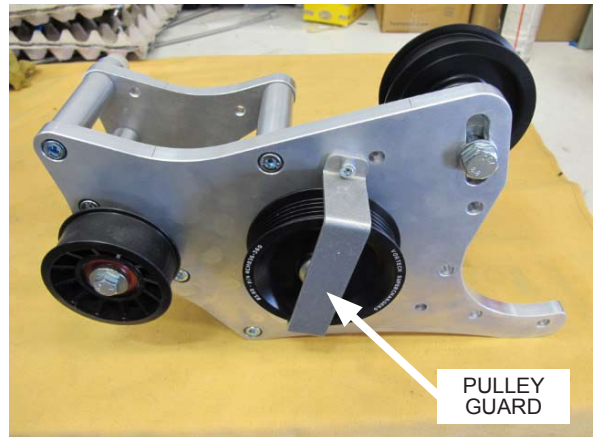

Fig. 6-a: Remove pulley guard

- B. Some of the hardware used to mount the supercharger mounting bracket assembly to the driver side cylinder head is blocked by the serpentine belt idler pulley. Temporarily remove the serpentine belt idler pulley and its hardware and set aside for reinstallation in a later step.



Fig. 6-b: Remove serpentine belt idler pulley

- C. In order to make space for mounting of the supercharger to the supercharger mounting bracket assembly, the cog belt idler pulley and its hardware will need to be removed and set aside for reinstallation in a later step.

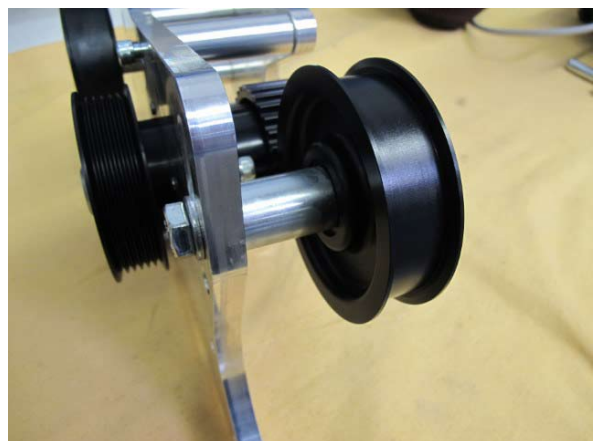

Fig. 6-c: Remove cog belt idler pulley

6. S/C MOUNTING BRACKET ASSEMBLY INSTALLATION

- D. The supercharger mounting bracket assembly will be mounted to the driver side cylinder head using three M8 x 85mm and one M8 x 110mm socket head cap screws. In Fig. 5-d, you will notice a spacer installed to the M8 x 110mm screw. There are two possible spacers that can be installed here, depending on your application. They are:

Vehicles with shaker hood: .360" spacer

Vehicles without shaker hood: .500" spacer

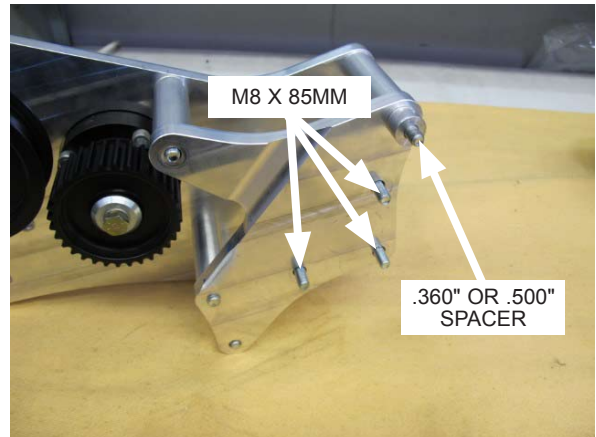

Fig. 6-d: S/C mounting bracket hardware

- E. Remove the harness that is attached to the front of driver side valve cover. Next, you will notice that there are four threaded holes on the driver side cylinder head. The supercharger mounting bracket assembly will be mounted to the driver side cylinder head using these four threaded holes.

Vehicles with Shaker hood: There is a screw that is installed where one of the supercharger mounting bracket assembly screws will be installed. Remove the screw as shown in Fig. 6-e. It will not be reused.

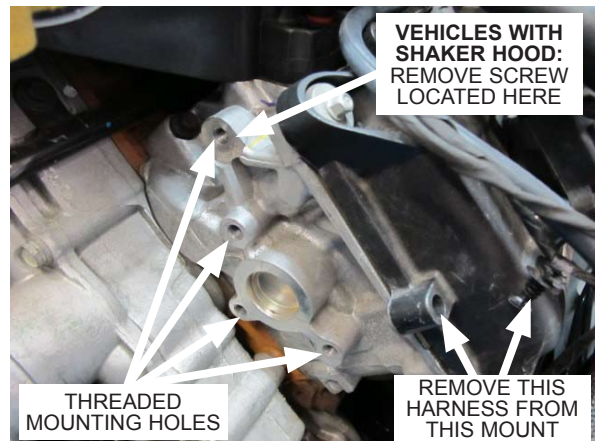

Fig. 6-e: Driver side cylinder head

- F. Place the supercharger mounting bracket assembly in front of the driver side cylinder head. Using a 6mm hex tool, attach the M8 x 110mm socket head cap screw and the correct length spacer as a pivot on the highest threaded mounting hole on the driver side cylinder head. Be sure that the correct length spacer is sandwiched between the supercharger mounting bracket assembly & the driver side cylinder head.

Vehicles with shaker hood: .360" spacer

Vehicles without shaker hood: .500" spacer

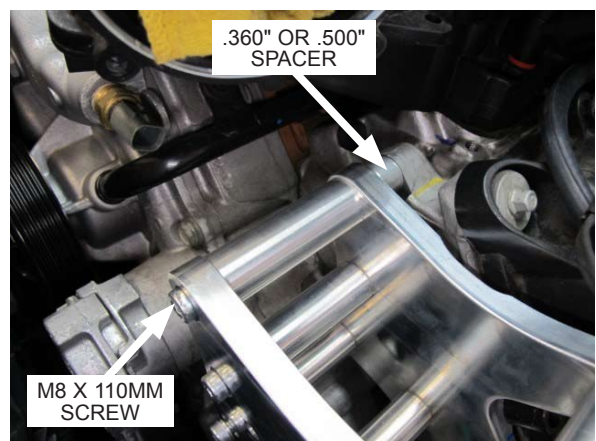

Fig. 6-f: Loosely attach S/C mounting bracket assembly to driver side cylinder head

6. S/C MOUNTING BRACKET ASSEMBLY INSTALLATION

- G. Using a 6mm hex tool, loosely attach the three M8 x 85mm socket head cap screws to the remaining three threaded holes on the driver side cylinder head. Now that all four M8 screws are in place, proceed to secure them to the driver side cylinder head.

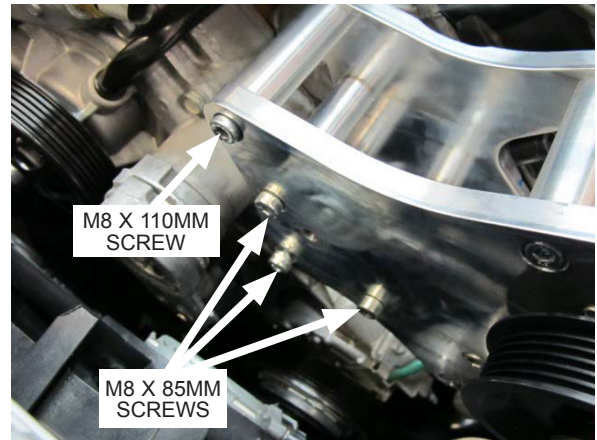

Fig. 6-g: Secure S/C mounting bracket hardware

- H. Locate the previously removed serpentine belt idler pulley and its hardware. Reinstall it to the supercharger mounting bracket assembly, making sure that the hardware is in the same order in which it was removed.

NOTE: If by accident you forget the order of the hardware for the serpentine belt idler pulley, refer to **Appendix A** near the back of this manual for the supercharger mounting bracket assembly diagram.



Fig. 6-h: Reinstall serpentine belt idler pulley

- I. Locate **Appendix B** near the back of this manual for the belt routing diagram and loosely route the provided serpentine drive belt as shown. Once in position, use a 3/8" drive ratchet or 3/8" drive breaker bar and rotate the belt tensioner clockwise, then slide the serpentine drive belt under the smooth idler pulley located on the passenger side of the engine, near the upper radiator hose. Once the belt is in position and properly routed, release the tension on the belt tensioner.

NOTE: The serpentine drive belt will be a tight fit. We suggest having a helper assist you during the installation of the serpentine drive belt.

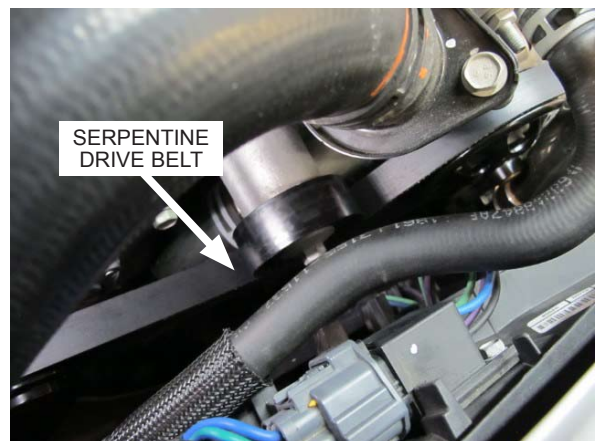

Fig. 6-i: Slide serpentine belt under OEM passenger side smooth idler pulley

6. S/C MOUNTING BRACKET ASSEMBLY INSTALLATION

- J. Locate the previously removed pulley guard and two 1/4"-20 x 1/2" screws. Using a 3/16" hex tool, reinstall the pulley guard to the super-charger mounting bracket assembly.



Fig. 6-j: Reinstall pulley guard

- K. Using a zip tie, secure the harness removed in step E to the A/C line as shown.

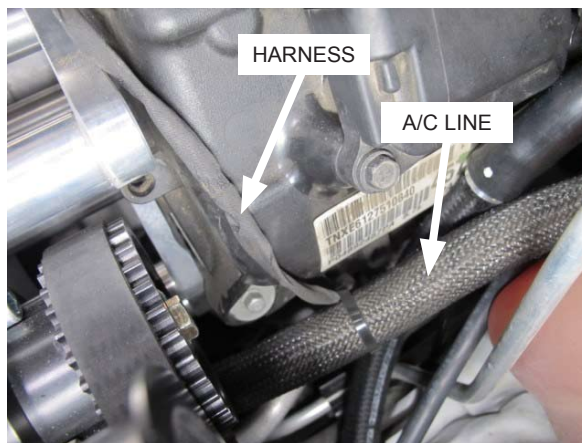

Fig. 6-k: Secure harness to A/C line

7. DISCHARGE ASSEMBLY & HEAT EXCHANGER INSTALLATION

- A. The upper section of the radiator is secured on each side by a plastic bracket. In order to provide space for the air/water cooler, these plastic brackets will need to be flipped 180° in order to tilt the radiator and A/C condenser away from the air/water cooler. Using a 10mm socket, remove the screw securing the upper radiator bracket. Do this for both sides. Discard the OEM screws as they will not be reused.



Fig. 7-a: Remove upper radiator bracket

- B. Locate the provided M6 x 1.0 x 30mm screw and .380" length aluminum spacer and install them to the bracket as shown. Do this for both brackets.



Fig. 7-b: Assemble hardware and spacer as shown

- C. Install the upper radiator support brackets as shown, making sure to sandwich .380" length aluminum spacer between the bracket and the upper core support. Secure using the provided M6 x 1.0 x 30mm screws. As you begin to secure the screws, you'll begin to see the radiator and A/C condenser slightly start to tilt back towards the engine. This is normal.



Fig. 7-c: Install upper radiator bracket as shown

7. DISCHARGE ASSEMBLY & HEAT EXCHANGER INSTALLATION

NOTE: In this section, the mounting hardware for the heat exchanger and air/water cooler must be left hand tight as some adjustment will be necessary when installing the discharge tubes.

- D. Locate the air/water cooler, 1/2" NPT x 3/4" barbed straight fitting, and 1/2" NPT x 3/4" barbed 45° fitting and assemble them as shown, making sure the 45° fitting is pointed down. Be sure to use pipe sealant on both threads of the fittings.

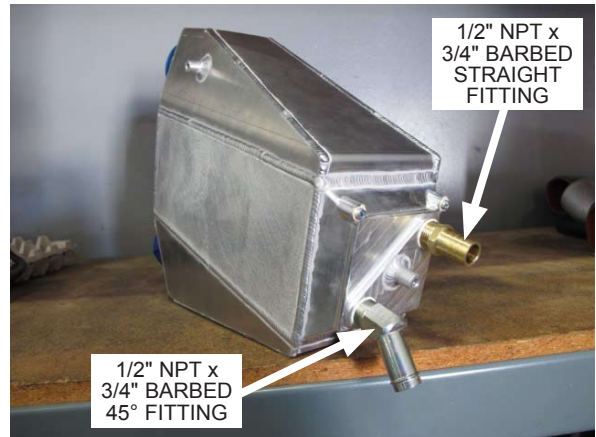

Fig. 7-d: Install fittings to air/water cooler

- E. Before beginning the installation of the air/water cooler, it is necessary to cover the front of the A/C condenser with a large piece of cardboard. Using the box the supercharger kit was shipped in, cut a piece large enough to cover most of the A/C condenser. This helps protect the A/C condenser during installation, but also leaves enough room between the A/C condenser and air/water cooler once the air/water cooler is installed. Use tape to secure the cardboard to the A/C condenser.

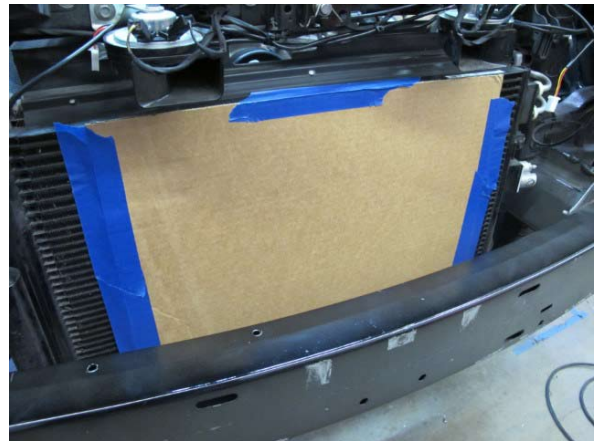

Fig. 7-e: Cover A/C condenser with cardboard

- F. Located on the lower driver side of the radiator is an aluminum bracket secured by a screw. Using a 10mm socket, remove the screw and aluminum bracket. Discard the aluminum bracket, but keep the screw.

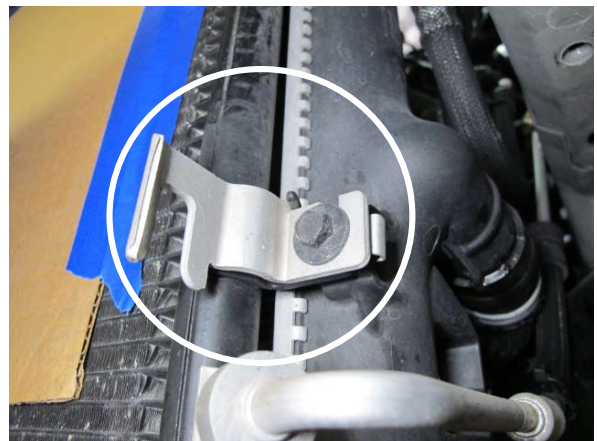

Fig. 7-f: Remove aluminum bracket and screw

7. DISCHARGE ASSEMBLY & HEAT EXCHANGER INSTALLATION

- G. Located on the lower passenger side of the radiator is another screw. Using a 10mm socket, remove the screw and set it aside.



Fig. 7-g: Remove screw

- H. Locate the provided heat exchanger. The side of the heat exchanger with the two ports is the passenger side of the heat exchanger. Locate the provided passenger side heat exchanger bracket, two 1/4"-20 x .50" screws, and two 1/4" washers. Loosely install the passenger side heat exchanger bracket to the heat exchanger as shown.



Fig. 7-h: Install passenger side heat exchanger bracket

- I. The side of the heat exchanger without any ports is the driver side of the heat exchanger. Locate the provided driver side heat exchanger bracket, two 1/4"-20 x .50" screws, and two 1/4" washers. Loosely install the driver side heat exchanger bracket to the heat exchanger as shown.



Fig. 7-i: Install driver side heat exchanger bracket

7. DISCHARGE ASSEMBLY & HEAT EXCHANGER INSTALLATION

- J. Using the screw removed in step D, loosely install the passenger side of the heat exchanger assembly to the radiator.



Fig. 7-j: Install passenger side of heat exchanger assembly

- K. Using the screw removed in step C, loosely install the driver side of the heat exchanger assembly to the radiator. Once in position, secure all of the heat exchanger assembly hardware.



Fig. 7-k: Install driver side of heat exchanger assembly

- L. In order to provide space for the upper air/water cooler support bracket, the driver side horn will need to be relocated. Using a 10mm socket, remove the screw securing the driver side horn to the core support. Keep the screw as it will be reused. The wiring harness for the driver side horn is attached to the core support. Using a panel removal tool, remove the harness from the core support.



Fig. 7-l: Remove driver side horn

7. DISCHARGE ASSEMBLY & HEAT EXCHANGER INSTALLATION

- M. Using a 10mm socket, remove the nut securing the horn bracket to the horn, then discard the horn bracket. It will not be reused. Next, locate the provided horn bracket and install it to the horn as shown. Secure with the previously removed nut.



Fig. 7-m: New horn bracket

- N. Located on the upper passenger side of the radiator is a mounting boss and screw. Using a 10mm socket, remove the screw and relocate the driver side horn to this location. Secure using the same screw.



Fig. 7-n: Relocate driver side horn to upper radiator

- O. Locate the upper air/water cooler support bracket and mount it to the original location of the driver side horn. Secure using the OEM screw.



Fig. 7-o: Install upper air/water cooler support bracket

7. DISCHARGE ASSEMBLY & HEAT EXCHANGER INSTALLATION

- P. There are two holes located on top of the front bumper support, near the passenger side. In order to secure the passenger side air/water cooler support bracket with the provided hardware, it will be necessary to drill completely through these two holes.



Fig. 7-p: 2x holes on front bumper support

- Q. Using the provided 9/32" x 6" length drill bit and a drill motor, drill through both holes on the front bumper support.

NOTE: Periodically stop and allow the drill bit to cool down. Overheating the drill bit may cause it to dull and potentially break. We suggest using cutting oil to ease this step.



Fig. 7-q: Drill through two holes on front bumper support

- R. Using two 1/4"-20 x 5.00" screws, two 1/4"-20 nylock nuts, and four 1/4" washers, Loosely install the passenger side air/water cooler support bracket to the front bumper support.



Fig. 7-r: Loosely install passenger side air/water cooler support bracket

7. DISCHARGE ASSEMBLY & HEAT EXCHANGER INSTALLATION

- S. Lower the air/water cooler into position and temporarily secure the passenger side of the cooler to the previously installed passenger side air/water cooler bracket using the provided 1/4"-20 x .50" socket head cap screw and 1/4" washer. Leave the screw hand tight at this time.



Fig. 7-s: Temporarily secure passenger side of air/water cooler

- T. Temporarily secure the top side of the air/water cooler to the previously installed upper air/water cooler support bracket using the provided 1/4"-20 x .50" hex head cap screw and 1/4" washer. Leave the screw hand tight at this time.



Fig. 7-t: Temporarily secure top side of air/water cooler

- U. Locate the provided driver side air/water cooler support bracket and loosely attach it to the driver side of the air/water cooler using the provided 1/4"-20 x .50" socket head cap screw and 1/4" washer. Leave the screw hand tight at this time. In order to secure the driver side air/water cooler support bracket to the front bumper support, two holes will need to be drilled through the front bumper support. Using the driver side air/water cooler bracket as a template, make a mark in the center of both slots.

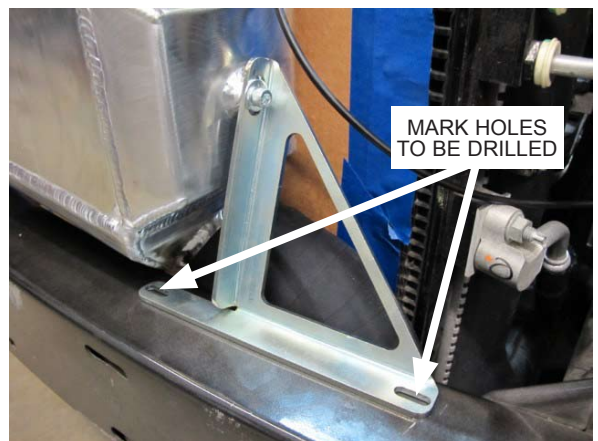

Fig. 7-u: Use driver side air/water cooler support bracket as drill template

7. DISCHARGE ASSEMBLY & HEAT EXCHANGER INSTALLATION

- V. Remove the air/water cooler from the vehicle, as well as the driver side and upper air/water cooler support bracket. Using the same 9/32" x 6" length drill bit that was used in Step M, drill through the two marked holes, making sure to go all the way through the front bumper support. Once the holes are drilled, loosely install the driver side air/water cooler support bracket using the provided two 1/4"-20 x 5.00" screws, two 1/4"-20 nylock nuts, and four 1/4" washers.

NOTE: Periodically stop and allow the drill bit to cool down. Overheating the drill bit may cause it to dull and potentially break. We suggest using cutting oil to ease this step.

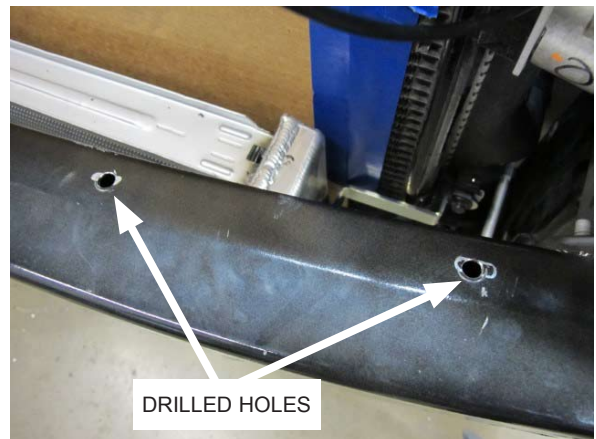

Fig. 7-v: Drill 2x holes using 6" length drill bit

- W. Locate discharge sleeve 'C' (S-shaped) that has two 45° bends in it. Notice one end of the sleeve is cut at an angle. The angled end of the sleeve will be installed to the air/water cooler. Keep this in mind for the next step.



Fig. 7-w: Discharge sleeve 'C'

- X. Orient the air/water cooler as shown. Notice that the 45° fitting on the passenger side is pointed down. Loosely install a straight Ø3.00" silicone sleeve and #48 hose clamp onto the inlet of the air/water cooler. Next, loosely install discharge sleeve 'C' and #44 hose clamp to the outlet of the air/water cooler, making sure that the angled end of discharge sleeve 'C' sits flush with the air/water cooler.



Fig. 7-x: Install silicone sleeves to air/water cooler as shown

7. DISCHARGE ASSEMBLY & HEAT EXCHANGER INSTALLATION

- Y. With the air/water cooler support brackets loosely installed on the vehicle, slide the air/water cooler into position. Discharge sleeve 'C' will be routed behind the front bumper support, then down under driver side frame rail. Once discharge sleeve 'C' is in position, proceed to secure the air/water cooler to all of the air/water cooler support brackets, then proceed to tighten all of the support bracket hardware. Make sure that the air/water cooler isn't being pressed into the A/C condenser. Adjust as necessary, then remove the cardboard that was used to protect the A/C condenser.

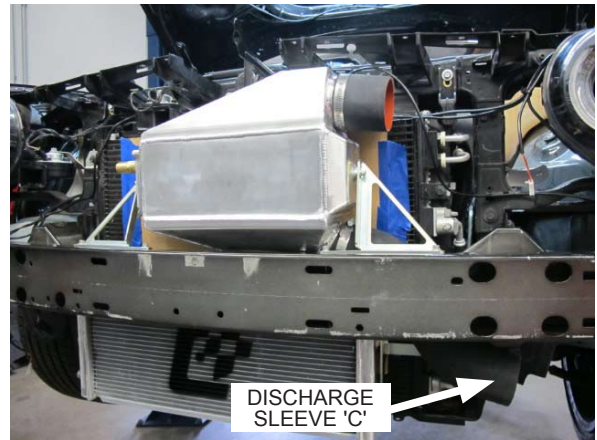

Fig. 7-y: Install air/water cooler

- Z. Locate discharge tube 'D'. Route the long end of the tube up into the engine compartment, as close to the radiator fan shroud as possible. Loosely install the short end of the tube into discharge sleeve 'C'.

NOTE: It may be necessary to further clear the radiator fan shroud to allow discharge tube 'D' to fit properly. Adjust as necessary. Refer to Section 4, Step J for reference.



Fig. 7-z: Loosely install discharge tube 'D'

- AA. Line up the mounting bracket on discharge tube 'D' with the two previously drilled holes on the lower radiator support and secure using two 1/4"-20 x .50" screws, two 1/2"-20 nylock nuts, and four 1/4" washers.

NOTE: The holes on the bracket that's welded to discharge tube D are slotted to allow for adjustment of the tube if necessary.



Fig. 7-aa: Secure discharge tube 'D' to lower radiator support

7. DISCHARGE ASSEMBLY & HEAT EXCHANGER INSTALLATION

- AB. Locate the factory air inlet tube and remove the intake air temperature sensor. Next, locate discharge sleeve 'E' (with molded boss). Insert the intake air temperature sensor into the molded boss, making sure that the alignment tab on the intake air temperature sensor is inserted into the alignment slot on the molded boss. Once in position, secure using the provided 28.6 step-less clamp.



Fig. 7-ab: Install IAT sensor to molded boss on discharge sleeve 'E'

- AC. Install discharge sleeve 'E' to discharge tube 'D' and to the throttle body, making sure that discharge sleeve 'E' is not rubbing against any sharp edges or pressed against the pulley guard on the supercharger mounting bracket assembly. Once in position, secure using a #48 and #56 hose clamp, then reconnect the IAT sensor.

NOTE: Further trimming of the radiator fan shroud may be necessary to provide proper clearance for discharge sleeve E. Trim as necessary. Refer to Section 4, Step J for reference.



Fig. 7-ac: Install discharge sleeve 'E' and reconnect IAT sensor

- AD. Locate discharge tube 'B' and install the bypass valve as shown. Secure the bypass valve to the discharge tube using the two 1/4"-20 x .750" socket head cap screws provided with the bypass valve.



Fig. 7-ad: Install bypass valve to discharge tube 'B'

7. DISCHARGE ASSEMBLY & HEAT EXCHANGER INSTALLATION

AE. Install the end of discharge tube 'B' without the bypass valve to the air/water cooler. Leave the hose clamps loose at this time.



Fig. 7-ae: Install discharge tube 'B'

AF. Using a Ø3.00 silicone bump sleeve and two #48 hose clamps, loosely install discharge tube A to discharge tube 'B', making sure to route discharge tube 'A' up into the engine compartment. Leave the hose clamps loose at this time.



Fig. 7-af: Loosely install discharge tube 'A' to discharge tube 'B'

AG. Locate the previously removed ambient air temperature sensor. On the back side of the sensor mount, there is a locating tab that needs to be grinded down. Proceed to grind down the locating tab, then using an M6 x 10mm screw and 1/4" washer, secure the ambient air temperature sensor to the underside of the front bumper support, near the passenger side.



Fig. 7-ag: Reinstall ambient air temperature sensor as shown

This page was left intentionally blank.

8. AIR INLET ASSEMBLY, BYPASS VALVE SIGNAL HOSE & S/C INSTALLATION

- A. Locate the provided air filter. With the 90° plastic fitting installed into the air filter, place the air filter into the vehicle as shown. Next, install a $\text{Ø}3.00$ to $\text{Ø}2.75$ " silicone reducer sleeve, one #48 hose clamp, and one #44 hose clamp to the other end of discharge tube 'A'. Leave the hose clamps loose at this time.

NOTE: The air filter must be in place prior to the supercharger being installed, as it is not possible to install the air filter after the supercharger is installed.



Fig. 8-a: Place air filter into position and install silicone sleeve to discharge tube 'A'

- B. Prior to installing the supercharger to the supercharger mounting bracket assembly, it is suggested that you lubricate the threads in the mounting bosses on the supercharger. To do this, use four 3/8-16 x 1.25" screws and lightly coat the screw threads with lubricant, then screw them into the mounting bosses until they bottom out. Once complete, remove the screws from the mounting bosses. This process makes it easier to install the screws into the supercharger.



Fig. 8-b: Lubricate supercharger mounting boss threads



Use blue threadlocker on all fasteners in this step.

- C. Place the supercharger onto the supercharger mounting bracket assembly and begin to thread the four 3/8-16 x 1.25" supercharger mounting screws by hand, making sure to use 3/8" washers on all screws. Once in position, proceed to tighten the four 3/8-16 x 1.25" supercharger mounting screws.



Fig. 8-c: Install supercharger to supercharger mounting bracket assembly

8. AIR INLET ASSEMBLY, BYPASS VALVE SIGNAL HOSE & S/C INSTALLATION

- D. Locate the previously removed cog belt idler pulley and its hardware and reinstall it to the supercharger mounting bracket assembly, making sure that the hardware is in the same order in which it was removed. Slide the cog belt over both cog pulleys and under the cog belt idler pulley. Using the cog belt idler pulley as a belt tensioner, push it down so it starts to tension the cog belt, then secure the cog belt idler pulley hardware.

NOTE: Do not apply excessive tension to the cog belt. By design, cog belts do not require the same amount of tension as a serpentine belt. Under the correct amount of tension, you should be able to easily "twist" the straight section of the cog belt about a 1/4 turn.



Fig. 8-d: Tension cog belt

- E. Locate the OEM breather hose. Notice one leg of the hose is slightly shorter than the other. Using hose cutters, remove 2.00" inches from the shorter end of the hose.



Fig. 8-e: Modify OEM breather hose

- F. Locate the provided 3/4" to 1/2" reducer fitting and 1/2" oil drain hose. Insert the 1/2" end of the reducer fitting into the 1/2" oil drain hose, then install the long leg of the modified OEM breather hose to the 3/4" end of the reducer fitting. No hose clamps are required for this step.



Fig. 8-f: Breather hose assembly

8. AIR INLET ASSEMBLY, BYPASS VALVE SIGNAL HOSE & S/C INSTALLATION

- G. Install the previously assembled breather hose assembly to the engine as shown. The modified OEM breather hose gets installed to its original location. Attach the other end of the breather hose assembly to the 1/2" x 90° fitting on the air filter. No hose clamps are required for this step.



Fig. 8-g: Install breather hose assembly

- H. Proceed to install the air filter to the supercharger inlet and secure using the hose clamp provided with the air filter. Next, proceed to install discharge tube 'A' to the supercharger outlet, but do not tighten the hose clamps at this time.



Fig. 8-h: Secure air filter and discharge tube A to supercharger

- I. With all discharge tubes and sleeves installed, verify that they are free and clear of any obstructions and adjust as necessary. Once in place, proceed to tighten all hose clamps using a 5/16" nut driver or flathead screw driver.



Fig. 8-i: Secure discharge tubes and discharge sleeves

8. AIR INLET ASSEMBLY, BYPASS VALVE SIGNAL HOSE & S/C INSTALLATION

- J. There is a 3/8" vacuum line attached to the brake booster. Cut the 3/8" vacuum line and install the provided brass vacuum tee. Locate the provided 7/32" vacuum hose and attach it to the vacuum tee, then route the vacuum line along the fuel injector harness, then under the supercharger and down towards the bypass valve on discharge tube 'B'.

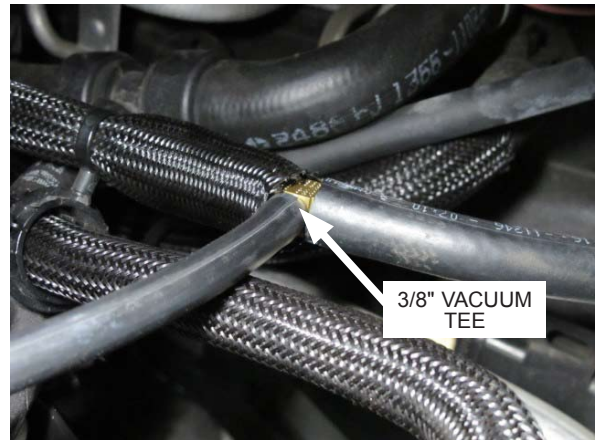

Fig. 8-j: Install vacuum tee

- K. Attach the 7/32" vacuum hose to the fitting located on the bypass valve lid.



Fig. 8-k: Attach vacuum hose to bypass valve

9. AIR-TO-WATER COOLING SYSTEM INSTALLATION

- A. Locate the provided auxiliary water pump harness. You will notice one end of the harness has a 10A fuse tap attached to it. Verify that this fuse is not damaged as it will replace a fuse in the fuse box in a later step.

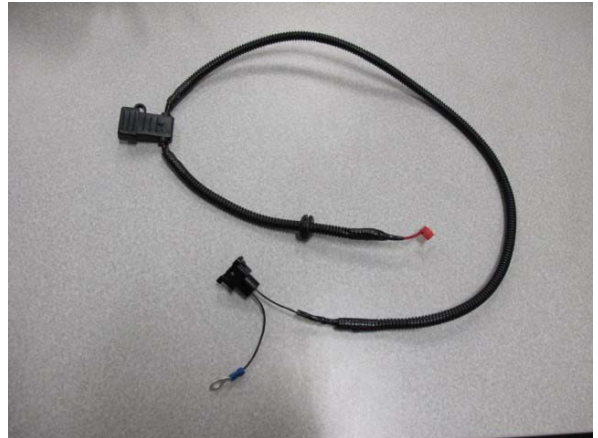

Fig. 9-a: Auxiliary water pump harness

- B. Using a 5/8" drill bit, drill through the back of the fuse box cover as shown. Pass the fuse tap through the hole, then secure the rubber grommet to the fuse box cover.



Fig. 9-b: Drill fuse box cover, install grommet and route wire into fuse box

- C. On the under side of the fuse box cover is a fuse diagram. Locate and remove fuse #37, then replace it with the fuse tap as shown. Reinstall the fuse box cover, then route the harness down towards the passenger side of the lower radiator support making sure to keep it away from sharp edges and moving objects.



Fig. 9-c: Install fuse from water pump harness as shown

9. AIR-TO-WATER COOLING SYSTEM INSTALLATION

- D. In order to provide clearance for the auxiliary water pump, the plastic fastener for the large harness connector will need to be removed. Disconnect the large harness connector, then using a pry tool, remove the large harness connector from its mounting location.

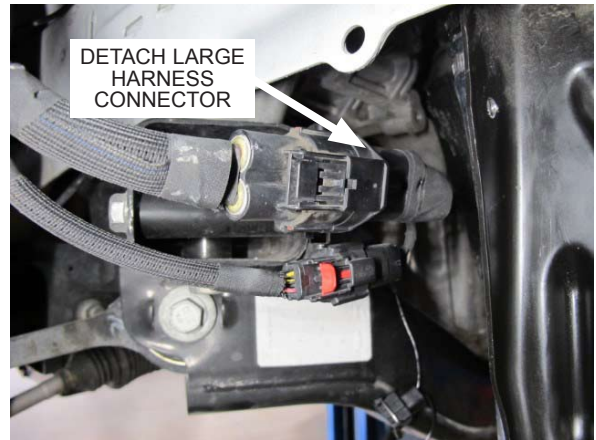

Fig. 9-d: Large harness connector

- E. Remove the plastic harness connector fastener from the connector and discard. It will not be reused. Reconnect the large harness connector at this time.



Fig. 9-e: Remove plastic harness connector fastener

- F. Using zip tie, secure the large harness connector to its original mount. Next, using an adel clamp, one 1/4"-20 x .50" socket head cap screw, one 1/4"-20 nylock nut, and one 1/4" washer, loosely mount the auxiliary water pump to the hole previously drilled on the passenger side of the lower radiator mount, making sure to place the ring terminal from the auxiliary water pump harness between the 1/4"-20 nylock nut and 1/4" washer. Position the auxiliary water pump so the outlet is positioned as shown. Once in position, connect the auxiliary water pump harness to the water pump.

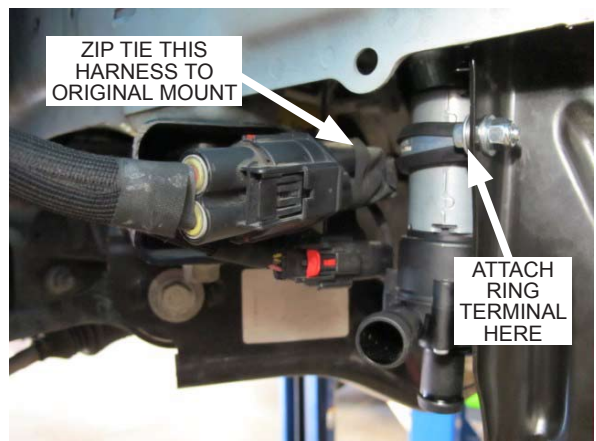

Fig. 9-f: Install the auxiliary water pump

9. AIR-TO-WATER COOLING SYSTEM INSTALLATION

- G. In order to provide room for one of the air/water cooling system hoses that gets attached to the heat exchanger, one of the front bumper support screws will need to be removed.

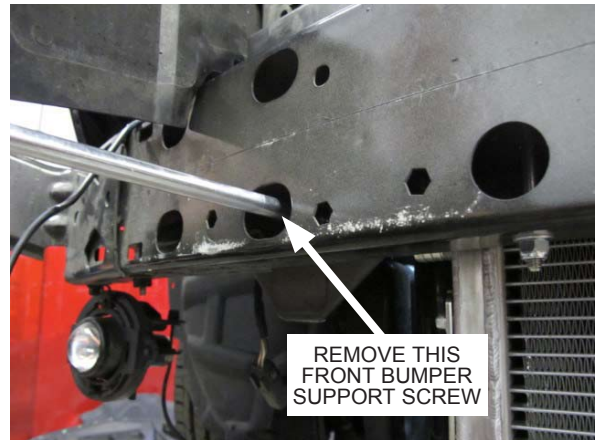

Fig. 9-g: Remove front bumper support screw

- H. Locate the provided M8 x 1.25 x 12mm socket head cap screw and install it where the previously removed front bumper support screw was located.



Fig. 9-h: Shorter front bumper support screw

- I. Locate both of the provided 3/4" x 150° molded hoses. Prior to being installed, they'll need to be modified. Using a pair of hose cutters, remove 1.00" from the short end of both hoses and 1/2" from the long end of both hoses.



Fig. 9-i: Modify 150° molded hose as shown

9. AIR-TO-WATER COOLING SYSTEM INSTALLATION

- J. Using one of the modified 3/4" x 150° molded hoses, attach the short end of the hose to the upper port of the heat exchanger. Loosely attach a #10 hose clamp, but do not tighten it at this time.



Fig. 9-j: Install short end of 150° molded hose to heat exchanger

- K. Attach the other end of the modified 150° molded hose to the 45° fitting on the air/water cooler core. Once the hose is in position, proceed to secure this end of the hose with another #10 hose clamp. Be sure to secure the #10 hose clamp installed in the previous step.



Fig. 9-k: Install long end of 150° molded hose to air/water cooler

- L. Using a 13mm socket, remove the nuts that secure the shock mount to the shock tower on the passenger side. Next, locate the provided mounting bracket for the air/water cooling system reservoir and install it as shown, then secure it using the same nuts that secure the shock mount to the shock tower.



Fig. 9-l: Install air/water cooler system reservoir mount

9. AIR-TO-WATER COOLING SYSTEM INSTALLATION

- M. Locate the provided air/water cooling system reservoir and install it to the previously installed mount on the shock tower. Secure using the provided M6 nylock nuts and M6 washers.



Fig. 9-m: Install air/water cooler system reservoir to mount

- N. Locate the provided length of 3/4" coolant hose and cut it down to 44". Next, locate the braided sleeve and cut a 57" piece. As you begin to slide the braided sleeve over the 3/4" coolant hose, it will begin to increase in diameter, thus shortening its overall length. Center the braided sleeve on the 3/4" coolant hose and use electrical tape to secure both ends. There should only be a few inches of coolant hose exposed on each end.



Fig. 9-n: 44" length of the 3/4" coolant hose

- O. Locate the provided 1/2" x 90° hose elbow. Measuring from the inside of the 90° bend, cut each leg down to 1.50".

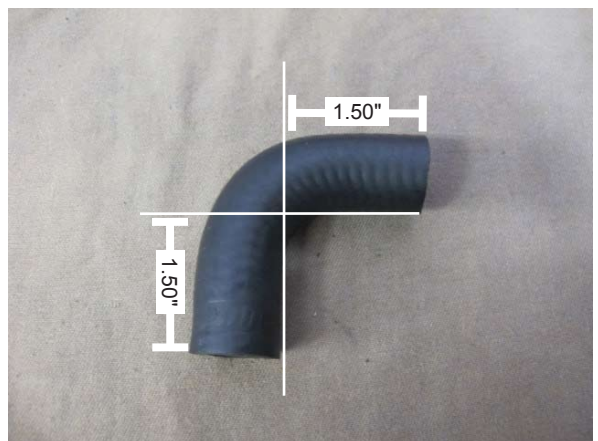

Fig. 9-o: Modify 1/2" x 90° coolant elbow as shown

9. AIR-TO-WATER COOLING SYSTEM INSTALLATION

- P. Locate the provided 3/4" x 1/2" x 90° brass reducer fitting and insert the 1/2" end of the fitting into one of the legs of the 1/2" x 90° hose.



Fig. 9-p: Insert brass fitting to 1/2" x 90° coolant hose elbow

- Q. Install the hose and brass fitting assembly to the plastic bung on the rear of the air/water cooling system reservoir and secure using two #6 hose clamps.



Fig. 9-q: Install hose and brass fitting assembly to air/water cooling system reservoir

- R. Locate the 44" length of 3/4" hose and attach one end of the hose to the brass fitting as shown. Secure using a #10 hose clamp.



Fig. 9-r: Attach 44" length of 3/4" coolant hose to the brass fitting as shown

9. AIR-TO-WATER COOLING SYSTEM INSTALLATION

- S. Route the 3/4" coolant hose from the air/water cooling system reservoir towards the air/water cooler, making sure to keep it away from the exhaust manifold, as well as sharp and/or moving objects. Secure using provided zip ties.



Fig. 9-s: Route 3/4" coolant hose towards air/water cooler

- T. Pass the 3/4" coolant hose between the radiator and the core support. Make sure the hose doesn't get pinched or kinked.



Fig. 9-t: Pass 3/4" coolant hose between radiator and core support

- U. Attach the 3/4" coolant hose to the straight fitting on the air/water cooler and secure using the provided #10 hose clamp.



Fig. 9-u: Attach 3/4" coolant hose to air/water cooler

9. AIR-TO-WATER COOLING SYSTEM INSTALLATION

- V. Locate the provided 3/4" x 90° molded hose. You will notice that one leg of the molded hose is shorter than the other. Loosely install the short leg of the molded hose to the lower port of the heat exchanger. Route the long leg of the hose towards the outlet of the auxiliary water pump and trim the hose down to size, making sure it is not kinked and clear of any sharp edges. Secure the molded hose using two #10 hose clamps. Once this hose is properly installed, go back and tighten the hardware securing the water pump to the lower radiator mount.

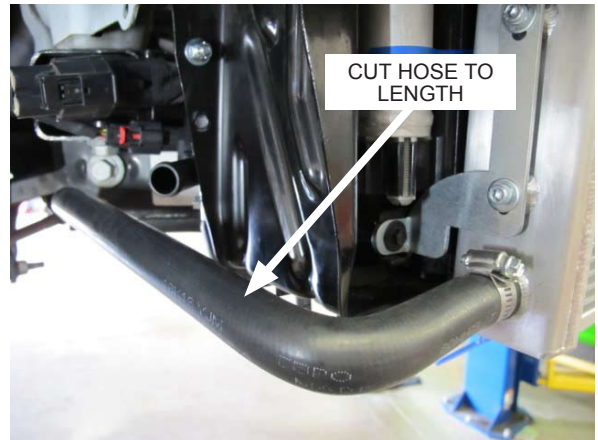

Fig. 9-v: Install 3/4" x 90° hose

- W. Locate the remaining 3/4" x 150° molded hose, 3/4" to 1/2" reducer fitting, 1/2" coolant hose, one #10 hose clamp, one #6 hose clamp, and braided sleeve. Cut the 1/2" coolant hose to 27.5", then cut the braided sleeve to 32". Use the 3/4" to 1/2" reducer fitting to join both hoses together, then secure them using the two hose clamps. Once the hose is assembled, slide the braided sleeve over the 1/2" coolant hose. As you begin to slide the braided sleeve over the 1/2" coolant hose, it will begin to increase in diameter, thus shortening its overall length. Center the braided sleeve on the 1/2" coolant hose and use electrical tape to secure both ends. There should only be a few inches of coolant hose exposed on each end.



Fig. 9-w: 3/4" x 150° to 1/2" coolant hose assembly

- X. Loosely install the 3/4" x 150° molded hose and a #10 hose clamp to the inlet of the auxiliary water pump. With the hose in properly routed, proceed to secure the hose to the electric water pump inlet using the #10 hose clamp. Once this end of the coolant hose assembly is secured, route the other end of this hose up towards the air/water coolant reservoir.



Fig. 9-x: Install coolant hose to electric water pump inlet

9. AIR-TO-WATER COOLING SYSTEM INSTALLATION

- Y. Using the coolant hose assembly from the previous step, install the 1/2" end of the coolant hose assembly and a #6 hose clamp to the air/water system coolant reservoir, making sure to keep it away from the exhaust manifold, as well as sharp and/or moving objects. Secure using provided zip ties.

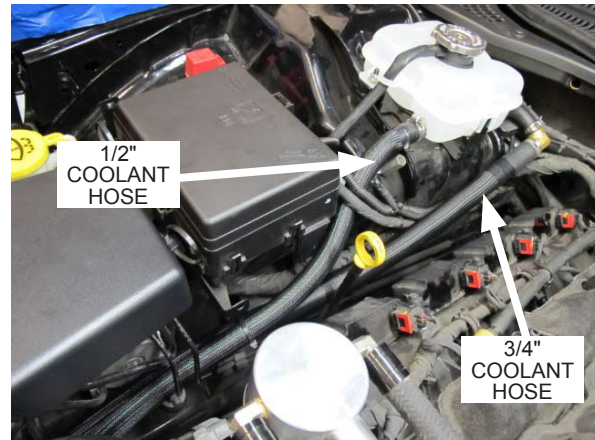

Fig. 9-y: Install coolant hose assembly and route towards electric water pump

- Z. Verify that all hose clamps for the air/water cooling system are secured, then begin to fill the air/water cooling system at the reservoir with 50/50 water/coolant mix. Check for leaks and correct if necessary. In order to properly purge the air/water system of air, the electric water pump needs to be turned on. To do this, the battery will need to be plugged back in and the vehicle turned to *RUN* mode, but **DO NOT START THE ENGINE**. To put the vehicle into *RUN* mode, **KEEP YOUR FOOT OFF OF THE BRAKE AND/OR CLUTCH**, then press the engine start button twice. This will turn on all vehicle accessories as well as turn on the electric water pump for the air/water cooling system. Continue to fill the air/water cooling system until all of the air has been purged. Only fill the air/water coolant reservoir to the line labeled *COLD FULL LEVEL*. Install reservoir cap once complete, then unplug the the battery again.



Fig. 9-z: Fill air/water cooling system with 50/50 water/coolant mix

This page was left intentionally blank.

10. RADIATOR SHROUD MODIFICATION & INSTALLATION

- A. Locate the 1.00" width radiator shroud bracket and one rubber mount. Insert the rubber mount to the hole on the radiator shroud bracket. Next, remove the screw to the left side of the hood latch mount using a 10mm socket. Place the radiator shroud bracket in front of the hood latch mount and loosely secure the previously removed hood latch screw.

NOTE: Notice that the radiator shroud brackets are slotted. This is to allow for further adjustment in a later step.



Fig. 10-a: 1.00" width radiator shroud bracket with rubber mount

- B. Locate the one of the 3/4" width radiator shroud brackets and one rubber mount. Insert the rubber mount to the hole on the radiator shroud bracket. Using a 10mm socket, remove the screw securing the passenger side upper radiator mount. Place the radiator shroud bracket in front of the passenger side upper radiator mount and loosely secure the previously removed screw. Repeat this step for the driver side upper radiator mount.

NOTE: Notice that the radiator shroud brackets are slotted. This is to allow for further adjustment in a later step.



Fig. 10-b: 3/4" width radiator shroud bracket with rubber mount

- C. Now that the air/water cooler is installed in front of the radiator, the radiator shroud will need to be modified.



Fig. 10-c: Radiator shroud

10. RADIATOR SHROUD MODIFICATION & INSTALLATION

- D. On the back side of the radiator shroud, you will notice a plastic rib that runs across the full length of the top side of the radiator shroud. Using a cutting tool, cut all across the full length of the radiator shroud, just below the rib shown in Fig. 10-d. Only the top section of the radiator shroud will be used.

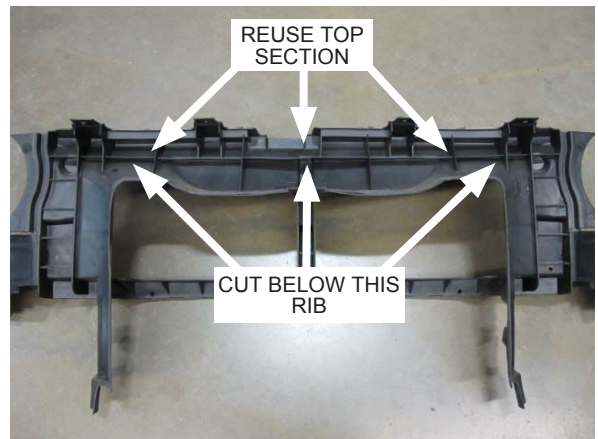

Fig. 10-d: Modify radiator shroud

- E. In order to properly install the modified radiator shroud, it will need to be clearanced so it can clear the top of the air/water cooler. Test fit the modified radiator shroud and make clearance adjustments as necessary.



Fig. 10-e: Modified radiator shroud to air/water cooler clearance

- F. Once the modified radiator shroud clears the air/water cooler, reinstall the modified radiator shroud and secure using the OEM plastic push pins. Next, position all three radiator shroud brackets so they are pressing up on the modified radiator shroud from the underside. Once they are in position, use a 10mm wrench to tighten the three screws securing the radiator shroud brackets. This will add support to the modified radiator shroud as the top side of the front bumper cover rests on top of the modified radiator shroud.

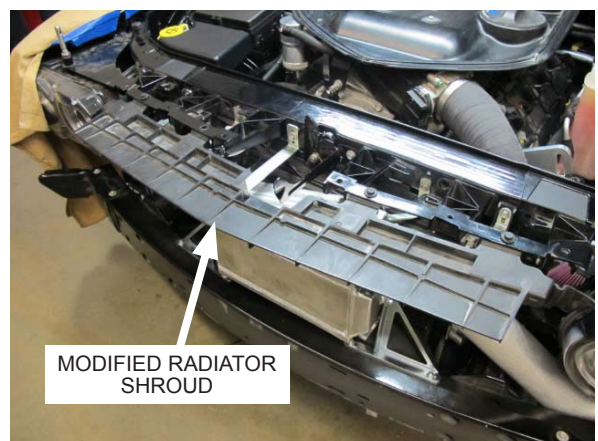

Fig. 10-f: Secure modified radiator shroud and three radiator shroud brackets

11. FUEL INJECTOR & MAP SENSOR REPLACEMENT (COMPLETE KIT ONLY)

- A. **Vehicles with Shaker hood:** There are three nuts and one screw that need to be loosened in order to raise the shaker mounting bracket to allow enough space for removal of the fuel injectors and MAP sensor. The shaker mounting bracket mounts are slotted, so the three nuts and one screw don't need to be completely removed. Two of the nuts are located on the back side of the engine. For this step, you will need the following tools:

Two rear nuts: 10mm wrench

Passenger side nut: 15mm socket

Driver side screw: 6mm hex tool

(See Step 6-f for screw location.)



Fig. 11-a: Shaker mounting bracket

- B. There are two breather hoses on the front side of the intake manifold, near the throttle body. Detach the hoses as shown. This is done to allow removal of the fuel rail assembly.



Fig. 11-b: Detach breather hoses

- C. On each of the eight fuel injector connectors is a red locking tab. Pull each red locking tab away from the fuel injector connector and proceed to unplug all eight fuel injector connectors.



Fig. 11-c: Disconnect fuel injectors

11. FUEL INJECTOR & MAP SENSOR REPLACEMENT (COMPLETE KIT ONLY)

- D. Remove both engine covers and both fuel rail covers from each fuel rail and set aside. Next, using a deep 9/16" socket, remove the four engine cover mounts (two per side) and set aside. These mounts secure the fuel rail to the intake manifold.

NOTE: Vehicles equipped with the Shaker hood only have a passenger side engine cover.

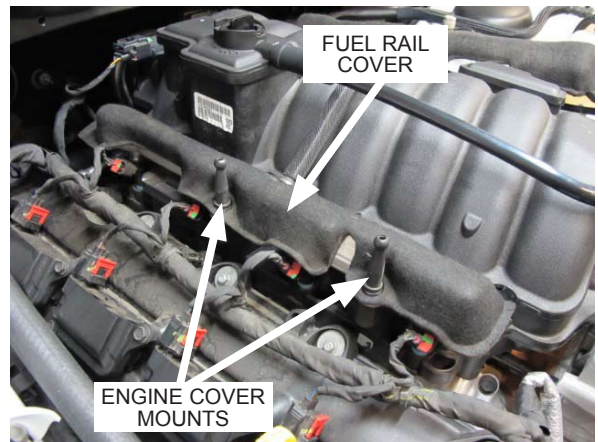

Fig. 11-d: Remove fuel rail covers, engine covers, and engine cover mounts (Passenger side shown)

- E. Located on the driver side fuel rail is the fuel feed line. Press on the blue quick-disconnect tabs, releasing the fuel feed line from the fuel rail. Place a rag underneath the fuel feed line when it is removed as there will be some fuel spillage. With the fuel feed line detached from the driver side fuel rail, proceed to remove the fuel rail assembly from the vehicle.

NOTE: The fuel rail may be pressurized. Take care to avoid spray and spills.



Fig. 11-e: Disconnect fuel feed line

- F. Note the orientation of the OEM fuel injectors in the fuel rails. Disengage the retaining clips & remove the OEM fuel injectors.

NOTE: In some cases, the o-rings from the OEM fuel injectors remain attached to the fuel rail or intake manifold. Before installing the provided high-flow fuel injectors, make sure that all o-rings from the OEM fuel injectors are accounted for. There should be sixteen total.



Fig. 11-f: Remove OEM fuel injectors

11. FUEL INJECTOR & MAP SENSOR REPLACEMENT (COMPLETE KIT ONLY)

- G. Install the provided high-flow fuel injectors into the fuel rails in the same orientation as the OEM injectors, then secure them using the OEM retaining clips.

NOTE: A very light coat of white lithium grease helps lubricate the o-rings, allowing them fit into the fuel rail easily.



Fig. 11-g: Install provided high-flow injectors

- H. With the provided high-flow fuel injectors installed, proceed to reinstall the fuel rail assembly to the vehicle, making sure to route the previously detached breather hoses above the fuel rail assembly. Reinstall both breather hoses and fuel rail covers. Do not install the engine covers at this time.



Fig. 11-h: Reinstall fuel rail assembly, fuel rail covers, and engine covers

- I. Located on the rear of the intake manifold on the passenger side is the OEM MAP sensor. Disconnect the MAP sensor connector and using a 7mm socket, remove the screw securing the OEM MAP sensor to the intake manifold. Remove the OEM MAP sensor and set it aside as it will not be reused. Replace the OEM MAP sensor with the provided 3-bar MAP sensor. Secure using the previously removed screw and reconnect the MAP sensor connector.

Vehicles with Shaker hood: After the MAP sensor has been swapped, place the shaker mounting bracket to its original position and resecure the three nuts and one screw previously loosened in Step A.

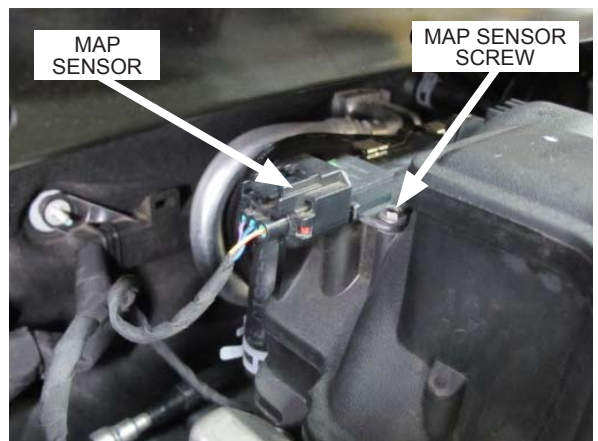

Fig. 11-i: Install 3-Bar MAP sensor

This page was left intentionally blank.

12. FUEL PUMP BOOSTER INSTALLATION (COMPLETE KIT ONLY)

- A. Remove the carpet from the trunk. Next, remove the trunk organizer located in the spare tire well.



Fig. 12-a: Remove trunk carpet and trunk organizer

- B. Using the fuel pump booster mounting plate as a template, mark two drill hole locations near the top center of the spare tire well.



Fig. 12-b: Mark two drill holes

- C. After the two drill holes have been marked, use a center punch to mark the center of the holes. This will help keep the drill bit from wandering when you begin to drill. Next, use a 17/64" drill bit to drill through the two marked drill holes. Once drilled, be sure to remove any burrs and sharp edges.



Fig. 12-c: Drill two mounting holes

12. FUEL PUMP BOOSTER INSTALLATION (COMPLETE KIT ONLY)

- D. The ground wire for the fuel pump booster will need to be extended with the black wire provided. Cut off the ring terminal already installed on the ground wire coming from the fuel pump booster. Using wire strippers, remove enough insulation from both ground wires, then solder the wires together and cover the solder joint with heat shrink or electrical tape. A butt connector is provided in case a soldering iron is not available to you. Next, using wire strippers, remove 1/4" of insulation from the remaining end of the ground wire and crimp on the provided ring terminal.

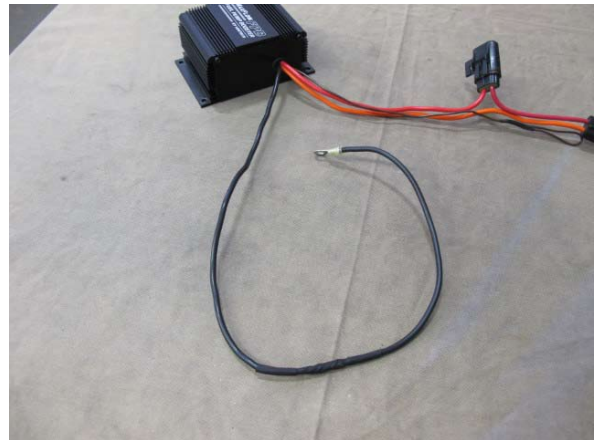

Fig. 12-d: Extend ground wire on fuel pump booster

- E. The brown wire on this fuel pump booster will not be used. Using electrical tape or heat shrink, close off the end of the wire.



Fig. 12-e: Seal off brown wire

- F. Using four 10-24 x .50" socket head cap screws, four 10-24 nylock nuts and four #10 washers, secure the fuel pump booster to the fuel pump booster mounting plate as shown.



Fig. 12-f: Mount fuel pump booster to fuel pump booster mounting plate

12. FUEL PUMP BOOSTER INSTALLATION (COMPLETE KIT ONLY)

- G. Using two 1/4"-20 x .75" hex head screws, two 1/4"-20 nylock nuts and four 1/4" washers, secure the fuel pump booster mounting plate to the vehicle using the previously drilled two mounting holes.

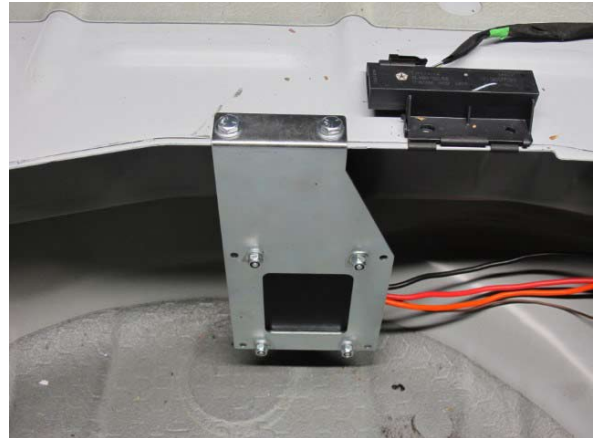

Fig. 12-g: Mount fuel pump booster mounting plate to vehicle

- H. Located near the positive battery terminal is a grounding stud. Using a 10mm socket, remove the nut from the stud, install the ground strap from the fuel pump booster to the stud, then secure using the same nut.



Fig. 12-h: Attach ground strap to grounding stud

- I. In order to access the fuel pump, the lower rear seat cushion will need to be removed. Notice the seat cushion retainers on each corner of the seat. These retainers slide into a slot in the rear seat base that secure it to the vehicle. There is one seat cushion retainer per side.



Fig. 12-i: Lower rear seat cushion retainers

12. FUEL PUMP BOOSTER INSTALLATION (COMPLETE KIT ONLY)

- J. Slide your hand underneath the lower rear seat cushion near the seat cushion retainer, then firmly pull up on the seat to release it from the vehicle. Do this for both corners of the lower seat cushion, then remove it from the vehicle.

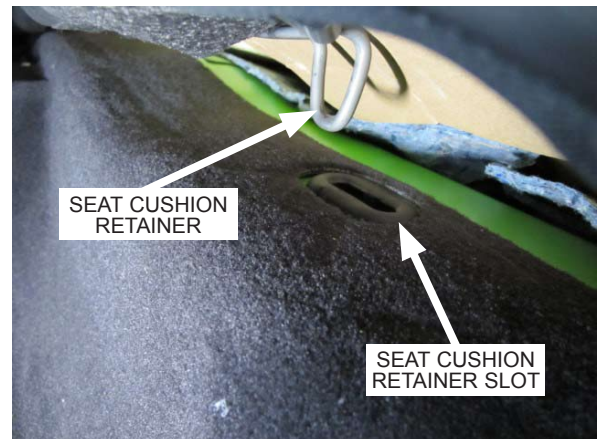

Fig. 12-j: Remove lower rear seat cushion

- K. Located on the driver side rear seat base is the fuel pump access panel. Using a panel removal tool, remove the fuel pump access panel.

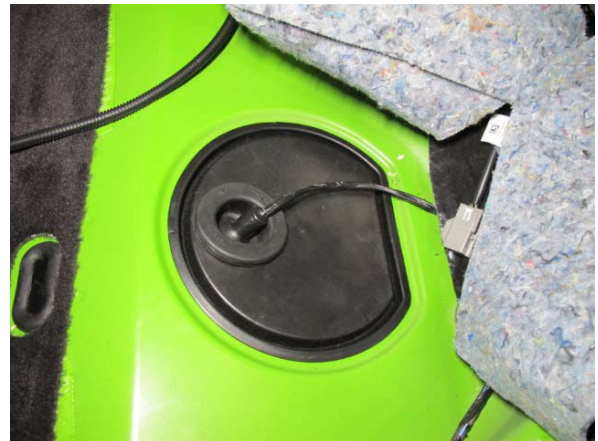

Fig. 12-k: Remove fuel pump access panel

- L. With the fuel pump access panel removed, disconnect the fuel pump connector from the fuel pump assembly. Temporarily remove the fuel pump access panel by removing the rubber grommet that secures the fuel pump connector to the fuel pump access panel. It will be necessary to drill a $\text{\O}1.00$ " hole in the fuel pump access panel as the fuel pump booster adapter harness will be routed towards the trunk.

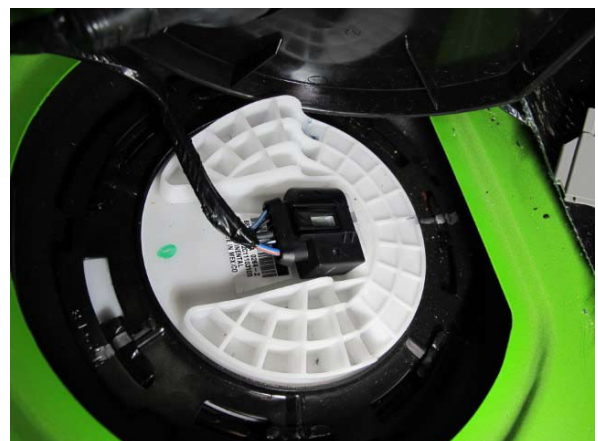

Fig. 12-l: Disconnect fuel pump

12. FUEL PUMP BOOSTER INSTALLATION (COMPLETE KIT ONLY)

- M. Using a Ø1.00" drill bit, drill a hole in the fuel pump access panel as shown. Reinstall the rubber grommet that secures the fuel pump connector to the fuel pump access panel.

NOTE: If a Ø1.00" drill bit is not available, you can use a smaller drill bit and widen the hole to size using a drum sander or a round file. Be sure the hole does not exceed Ø1.00".



Fig. 12-m: Modify fuel pump access panel

- N. Locate the provided fuel pump booster adapter harness and install it as shown. Pass the 2-wire fuel pump booster connector through the previously drilled Ø1.00 hole on the fuel pump access panel.



Fig. 12-n: Install fuel pump booster harness

- O. You will notice that the fuel pump booster harness has a grommet installed. Use that grommet to secure the fuel pump booster harness to the fuel pump access panel. Route the 2-wire fuel pump booster connector towards the fuel pump booster previously installed in the trunk. Verify that all connections are secure and that all wires are free and clear of any sharp edges. Reinstall the fuel pump access cover.



Fig. 12-o: Reinstall fuel pump access panel

12. FUEL PUMP BOOSTER INSTALLATION (COMPLETE KIT ONLY)

- P. Located near the battery is a plastic wire harness guide. Using a panel removal tool, remove the upper half of the plastic wire harness guide. Loosely route the fuel pump booster adapter harness along the large power wire, inside the wire harness guide, and down towards the fuel pump booster.



Fig. 12-p: Route the fuel pump booster adapter harness along the large power wire

- Q. Verify that the fuel pump booster adapter harness is routed correctly, making sure that it is free and clear of any sharp objects. Once in position, connect the fuel pump booster adapter harness to the fuel pump booster, reinstall the upper half of the wire harness guide, and secure the fuel pump booster adapter harness to the large power wire using the provided zip ties. Reinstall the trunk organizer and carpet at this time.



Fig. 12-q: Secure fuel pump booster adapter harness

- R. Reinstall the lower rear seat cushion and verify that the seat cushion retainers snap back into the seat cushion retainer slots.

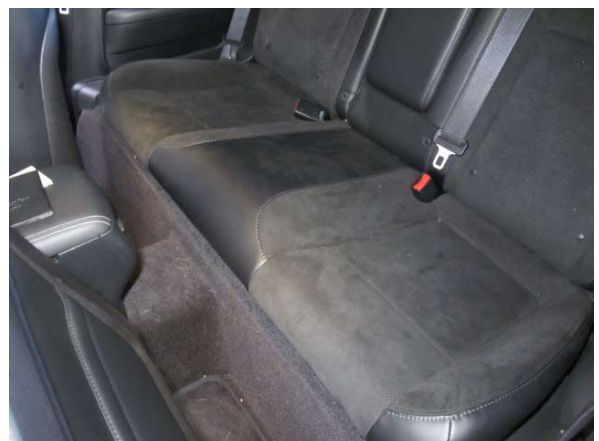

Fig. 12-r: Reinstall lower rear seat cushion

13. MISC. REASSEMBLY

- A. Due to possible interference from the discharge tubes and the electric water pump for the air/water cooling system, it may be necessary to remove the front brake cooling ducts, depending on your vehicle. Test fit the front bumper cover and check for front brake cooling duct interference. If there is interference, proceed to remove both front brake cooling ducts. They will not be reused.



Fig. 13-a: Front brake cooling ducts

- B. Reinstall the front bumper cover, reconnect the fog lights, reinstall the engine service panel, and reposition the fender liners. Since the fender liners were originally riveted in place using plastic rivets, replacement plastic rivets have been provided.



Fig. 13-b: Reinstall front bumper cover

- C. Locate the six provided plastic rivets. Using a rivet gun, resecure the fender liners to the front bumper cover using three rivets per side. If a rivet gun is not available to you, simply hold down the base of the plastic rivet using a pair of pliers, then pull the center of the plastic rivet towards you using another pair of pliers. Once you feel them snap into place and secure the fender liner, simply cut off the excess material from the plastic rivet.



Fig. 13-c: Resecure using provided plastic rivets

13. MISC. REASSEMBLY

- D. **Vehicles without Shaker hood:** It will be necessary to modify the front outer edge of the engine cover to allow the breather hose to clear. Test fit the engine cover and modify as necessary.

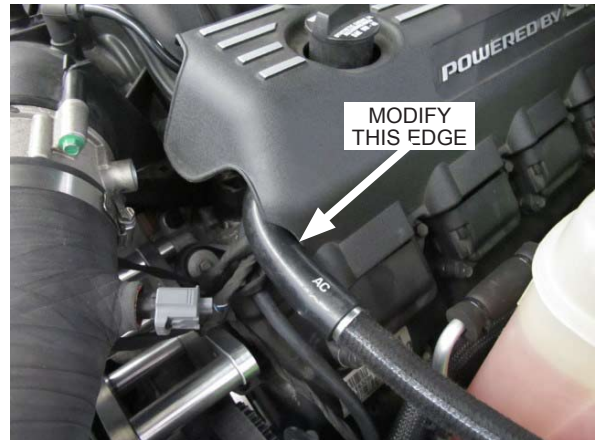

Fig. 13-d: Modify driver side engine cover

- E. **Vehicles without Shaker hood:** Proceed to reinstall both engine covers.



Fig. 13-e: Reinstall both engine covers

- F. **Vehicles with Shaker hood:** Proceed to reinstall the passenger side engine cover, shaker base and shaker scoop. Resecure using all previously removed hardware.



Fig. 13-f: Reinstall engine cover, shaker base, and shaker scoop

14. PROGRAMMING CABLE INSTALLATION (2018-2019 VEHICLES ONLY)

- A. The programming cable from Livernois Motorsports is required to tune 2018-2019 vehicles. Be sure you have this cable before moving forward.

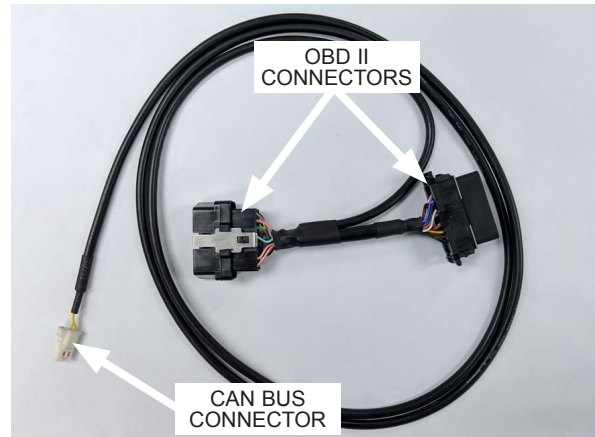

Fig. 14-a: Programming cable

- B. Located on the passenger side of the dash directly under the glove box is a fabric panel retained by three plastic fasteners. Using a panel removal tool, remove the three plastic fasteners and disconnect the footwell light connector. With the fabric panel removed, you will notice a green CAN bus junction block on the right side of the underside of the dash. One end of the programming cable will be installed into this junction block. Keep this in mind moving forward.

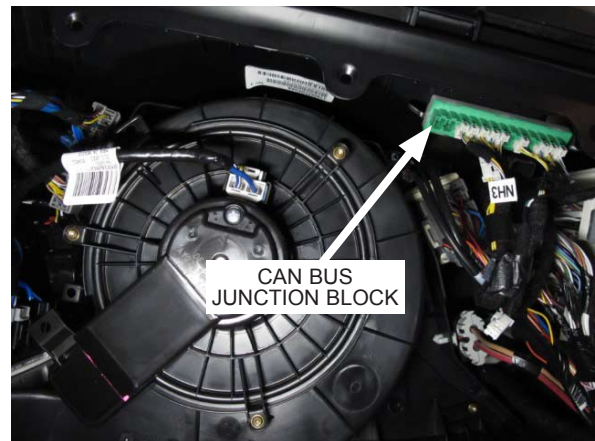

Fig. 14-b: CAN bus junction block

- C. Located on the driver side near the parking brake is the factory OBD II port. You'll notice that it is held in place to its mounting bracket using locking tabs (one per side). Using a flat-head screw driver, press both the locking tabs inward, then push the factory OBD II port out of its mounting bracket. The OBD II port on the programming cable will be installed in its place.



Fig. 14-c: Factory OBD II port locking tabs

14. PROGRAMMING CABLE INSTALLATION (2018-2019 VEHICLES ONLY)

- D. Connect the factory OBD II port to the provided programming cable. Secure both connectors together using a zip tie, making sure not to damage any of the wires on either OBD II port.



Fig. 14-d: Secure programming cable to factory OBD II port

- E. Install the OBD II port from the programming cable to the factory OBD II port mounting bracket. Route the CAN bus connector on the programming cable behind the dash and over to the CAN bus junction block on the passenger side of the dash. Use zip ties to secure the cable out of the way of any obstructions.



Fig. 14-e: Programming cable OBD II port installed

- F. Connect the CAN bus connector from the programming cable to any open port on the CAN bus junction block. Once installed, use zip ties to secure the cable out of the way. Once the programming cable is installed, proceed to reinstall the fabric panel on the passenger side of the dash, directly under the glove box. Be sure to connect the footwell light connector before securing the fabric panel.

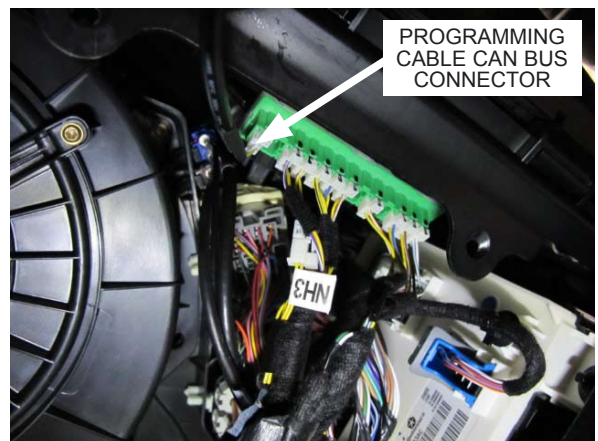

Fig. 14-f: Connect CAN bus connector

15. REFLASH COMPUTER (COMPLETE KIT ONLY)

NOTE: This section applies to 'Complete' supercharger systems. All others proceed to **Section 16**.

NOTE: The software provided to load the tune to the handheld device is compatible only with Windows 7 and newer based computers and can be found at <https://www.livernoismotorsports.com/downloads>. **The handheld device is sent out without a tune**, so you will need to provide a tune request via email to Livernois Motorsports.

- A. Install Livernois MyCalibrator software on your Windows 7, 8, 8.1, or 10 machine:
1. After install is complete, connect device to PC via supplied USB cable.
 2. The program should connect automatically with the tuner displaying serial number, firmware version number, and will check for updates. Please follow all on-screen prompts and fully complete all updates for MyCalibrator Software and MyCalibrator Touch Tuner before connecting to vehicle.
 3. Complete registration prompt.
- B. Before connecting:
1. Turn off all accessories and unplug any electronic devices from any power or USB ports (A/C, radio, auto lights, etc.).
 2. Set the device on a stable, flat surface.
 3. Do not touch anything until it finishes.
 4. Do not let anyone else approach the vehicle. Do not open the doors and be sure that the radio is in the '**OFF**' position.
 5. Be sure your vehicle's battery is sufficiently charged, otherwise use a battery tender to ensure that the battery doesn't fall below 12 volts.
 6. On vehicles with active cruise control and rain sensing wipers, it is normal for the warning light on top of the dash and the wipers to turn on (unless rain sensing is shut off).
 7. For vehicles with push-button ignition, **KEEP YOUR FOOT OFF THE BRAKE**, then press the start button twice to enter '**RUN**' mode. **DO NOT START THE VEHICLE**.
 8. Retrieve the ECU Code / S.W. Code by selecting '**MODULE INFO**' from the main menu.
 9. Record and provide these 2 codes, along with the items identified in section 'D' on the next page.
- C. Installation:
1. Saving your stock tune file:
 - i. With the device still connected to the OBD-II port, vehicle in '**RUN**' mode, and the engine turned off, select the '**PROGRAM VEHICLE**' option in the main menu and follow the on-screen prompts to read/save your stock tune file. Do not turn off the ignition until the device prompts you to do so.
 2. Sending your stock tune to Livernois Motorsports:
 - i. Connect MyCalibrator Touch to Windows PC.
 - ii. Run MyCalibrator Program.
 - iii. Confirm that the VIN now displays on MyCalibrator Program.
 - iv. Allow program to send stock file to Livernois Motorsports for backup purposes.
 3. Requesting your Vortech Supercharger Tune:
 - i. Email Livernois Motorsports with the items identified in section 'D' below.
 4. Downloading your Tune:
 - i. After receiving your email/communication from Livernois Motorsports stating your tune file is ready, connect MyCalibrator Touch to Windows PC.
 - ii. Run MyCalibrator Program.
 - iii. Allow download process to complete.
 - iv. Confirm program now shows '**VORTECH TUNE**' in addition to the '**STOCK**' file.

15. REFLASH COMPUTER (COMPLETE KIT ONLY)

C. Installation (continued):

5. Installing your Tune:

- i. Turn off all accessories & unplug any electronic devices from any power or USB ports (A/C, radio, auto lights, etc.).
- ii. Set the device on a stable, flat surface.
- iii. Do not touch anything until it finishes.
- iv. Do not let anyone else approach the vehicle. Do not open the doors and be sure that the radio is in the **'OFF'** position.
- v. Be sure your vehicle's battery is sufficiently charged, otherwise use a battery tender to ensure that the battery doesn't fall below 12 volts.
- vi. On vehicles with active cruise control and rain sensing wipers, it is normal for the warning light on top of the dash and the wipers to turn on (unless rain sensing is shut off).
- vii. For vehicles with push-button ignition, **KEEP YOUR FOOT OFF THE BRAKE**, then press the start button twice to enter **'RUN'** mode. **DO NOT START THE VEHICLE.**
- viii. Select **'PROGRAM VEHICLE'** option from main menu.
- ix. Select **'PRELOADED TUNES'** option on the tuner.
- x. Touch and drag to select **'VORTECH TUNE'**.
- xi. Confirm **'VORTECH TUNE'** is selected and follow all on screen prompts.

6. After install of tuning:

- i. Check vehicle for any possible fuel leaks, and if none present, start vehicle.
- ii. If your vehicle is equipped with an automatic transmission, several miles and/or days of driving may be required for all adaptive learning to complete. Do not be alarmed at shift quality immediately after installing of tune. It is recommended to do light throttle driving until shift quality has stabilized.

D. When sending in your tune request via email, please include the required information below:

1. First Name
2. Last Name
3. Street Address
4. City
5. ZIP / Postal Code
6. Phone Number
7. Email Address
8. Serial Number From Device
9. Vehicle Year
10. Vehicle Make
11. Vehicle Model
12. Engine
13. Octane of Fuel**
14. ECU / Strategy Code
15. SW ID Number

******(Vortech tune **requires** use of 91 octane fuel. Use of another fuel will void emissions compliance.)

Email all tune requests to:

tuning@livernoismotorsports.com

Livernois Motorsports business hours - 9:00am - 6:00pm EST

Please allow 24-48 business hours to create the tune.

16. FINAL CHECK

WARNING: Do not attempt to operate the vehicle until all components are installed and all operations are completed including the final check.

- A. If your vehicle has gone over 15,000 miles since its last spark plug change, you will need to change the spark plugs now *before* test driving the vehicle.
- B. Check all fittings, nuts, bolts and clamps for tightness. Pay particular attention to oil and fuel lines around moving parts, sharp edges and exhaust system parts. Make sure all wires and lines are properly secured with clamps or tie-wraps.
- C. Check all fluid levels, making sure that your tank(s) is/are filled with 91 octane or higher fuel before commencing test drive.
- D. Start the engine and allow to idle a few minutes, then shut off.
- E. Recheck to be sure that no hoses, wires, etc. are near exhaust headers or moving parts. Look also for any signs of fluid leakage.
- F. **PLEASE TAKE SPECIAL NOTE:** Operating the vehicle without ALL the subassemblies completely and properly installed may cause **FAILURE OF MAJOR COMPONENTS.**
- G. Test drive the vehicle.
- H. Always listen carefully for engine detonation. Discontinue heavy throttle usage if detonation is heard.
- I. Read the **STREET SUPERCHARGER SYSTEM OWNER'S MANUAL AND RETURN THE WARRANTY REGISTRATION FORM** within thirty (30) days of purchasing your supercharger system to qualify.

For internally lubricated V3 units only

This supercharger has been factory pre-filled with special Vortech synthetic lubricant. Oil does not need to be added to a brand new unit; however a fluid level check should be performed.

Prior to operating the supercharger on the vehicle and after installation onto the vehicle:

Remove the factory installed flat-head brass shipping plug (not the dipstick) from the top of the supercharger case. Replace the sealed shipping plug with the supplied "vented" plug. Do not operate the supercharger without it. Check the supercharger fluid level.

Fluid level checking procedure:

1. Ensure that the .06" copper sealing washer is located on the dipstick base.
2. Thread the clean dipstick into the unit until it seats.
3. Once the dipstick has seated, remove the dipstick from the unit. Fluid should register in the crosshatched area on the dipstick.
4. **DO NOT OVERFILL!!!** Drain excess fluid from the unit if it is above the maximum level on the dipstick.

Check the fluid level using the dipstick at least every 2,500 miles.

Initial supercharger fluid change must be performed at 2,500 miles. The supercharger fluid must be changed at least every 7,500 miles.

Drain the fluid, refill the unit with 4 oz. of Vortech V3 synthetic lubricating fluid and then confirm proper oil level using the dipstick. **DO NOT OVERFILL!!!**

WARNING: Use of any other fluid other than the special Vortech/Paxton synthetic lubricant will void the warranty and may cause component failure.

APPENDIX A. DIAGRAM, ASSEMBLY, SUPERCHARGER MOUNTING BRACKET

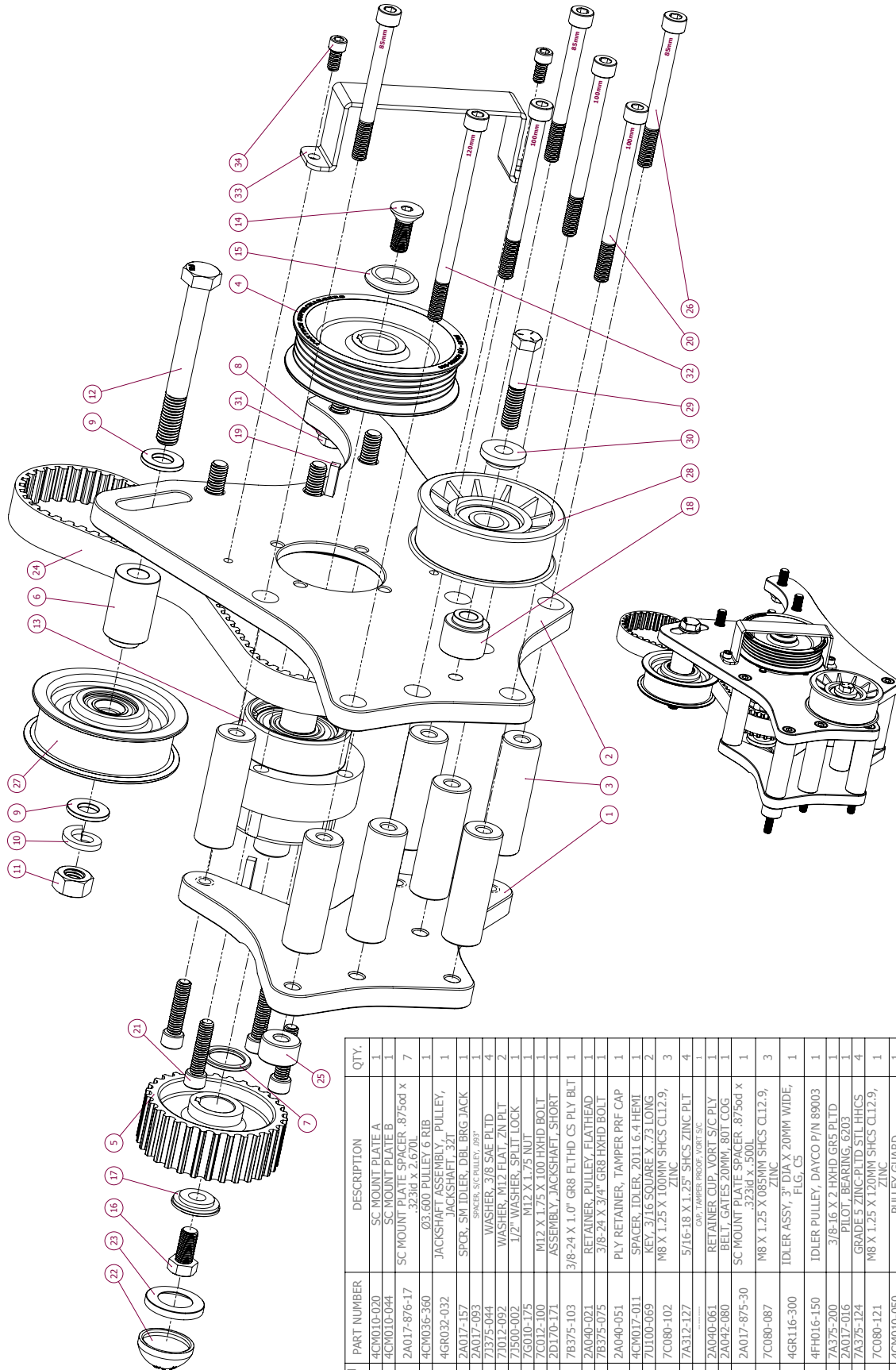

ITEM NO.	PART NUMBER	DESCRIPTION	QTY.
1	4CM010-020	SC MOUNT PLATE A	1
2	4CM010-044	SC MOUNT PLATE B	1
3	2A017-876-17	SC MOUNT PLATE SPACER .8750d x .323id x 2.670L	7
4	4CM0366-360	.03.600 PULLEY 6 RIB	1
5	4GR032-032	JACKSHAFT ASSEMBLY, PULLEY, JACKSHAFT, 32T	1
6	2A017-157	SPCR, SM IDLER, DBL BRG JACK	1
7	2A017-093	SPKR, SC PALLEY, .037	4
8	71375-044	WASHER, 3/8 SAE PLTD	2
9	71012-092	WASHER, M12 FLAT, ZN PLT	1
10	71500-002	1/2" WASHER, SPLIT LOCK	1
11	7G010-175	M12 X 1.75 X 100 HXHD BOLT	1
12	7C012-100	M12 X 1.75 X 100 HXHD BOLT	1
13	2D170-171	ASSEMBLY, JACKSHAFT, SHORT	1
14	7B375-103	3/8-24 X 1.0" GR8 FLTHD CS PLY BLT	1
15	2A040-021	RETAINER, PULLEY, FLATHEAD	1
16	7B375-075	3/8-24 X 3/4" GR8 HXHD BOLT	1
17	2A040-051	PLY RETAINER, TAMPER PRF CAP	1
18	4CM017-011	SPACER, IDLER, 2011 6.4 HEMI	1
19	7U100-069	KEY, 3/16 SQUARE X .73 LONG	2
20	7C080-102	M8 X 1.25 X 100MM SHCS CL12.9, ZINC	3
21	7A312-127	5/16-18 X 1.25" SHCS ZINC PLT	4
22	2A040-061	RETAINER CUP, VORT 5/C PLY	1
23	2A042-080	BELT, GATES 20MM, 80T COG	1
24	2A017-875-30	SC MOUNT PLATE SPACER .8750d x .323id x .500L	1
25	7C080-087	M8 X 1.25 X 085MM SHCS CL12.9, ZINC	3
26	4GR116-300	IDLER ASSY, 3" DIA X 20MM WIDE, FLG, CS	1
27	4FH016-150	IDLER PULLEY, DAYCO P/N 89003	1
28	7A375-200	3/8-16 X 2 HXHD GR5 PLTD	1
29	2A017-016	PILOT, BEARING, 6203	1
30	7A375-124	GRADE 5 ZINC-PLTD STL HHCS	4
31	7C080-121	M8 X 1.25 X 120MM SHCS CL12.9, ZINC	1
32	4CM010-050	PULLEY GUARD	1
33	7A250-050	1/4-20 X .50" SHCS ZINC PLT	2

P/N: 4CM020-010 v2.0, 08/08/19
 ©2019 Vortech Engineering, Inc.
 All Rights Reserved, Intl. Corp. Secured

APPENDIX B. DIAGRAM, BELT ROUTING

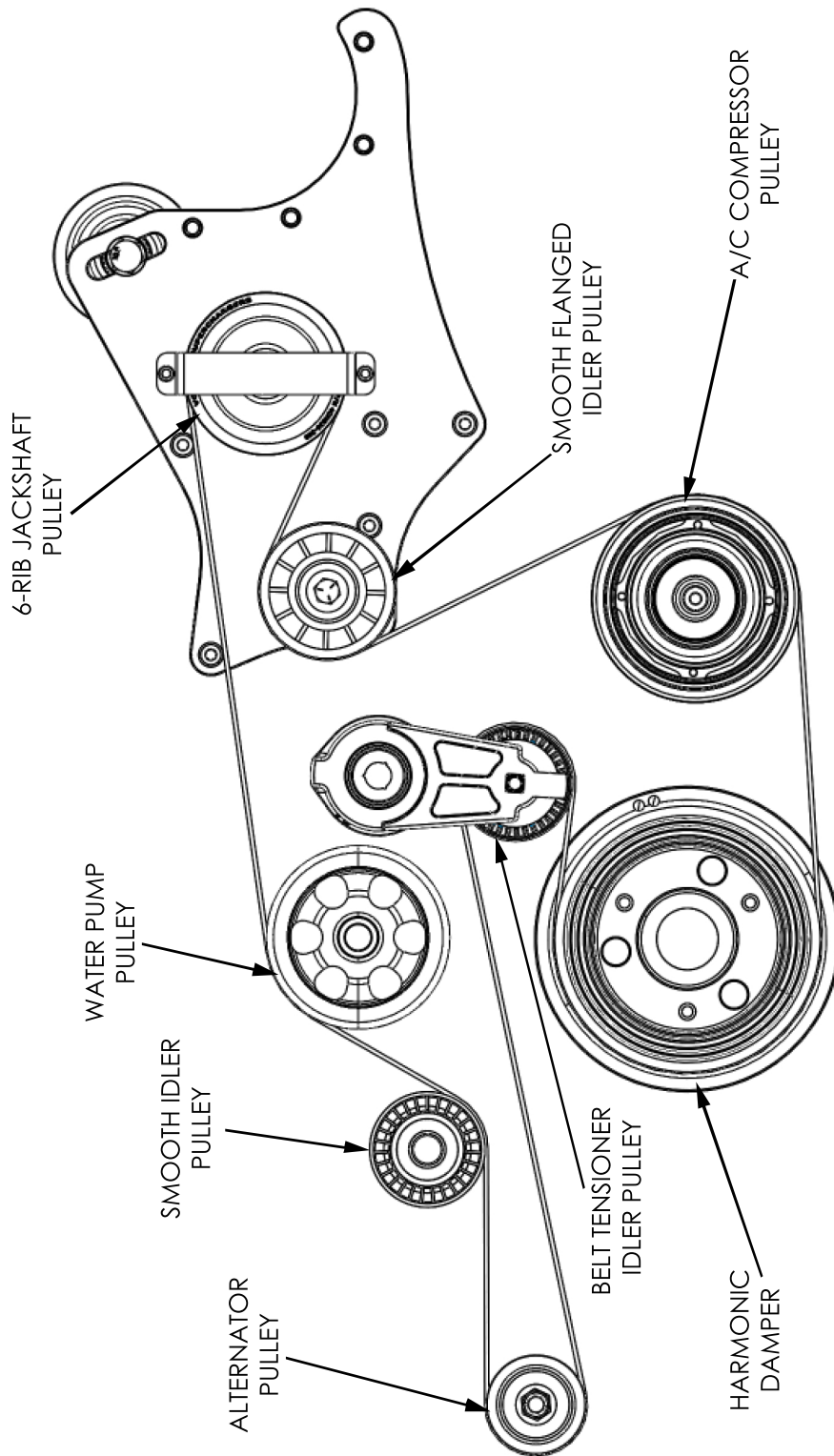

APPENDIX C. DIAGRAM, AIR-TO-WATER COOLING SYSTEM

ITEM NUMBER	QUANTITY	PART NUMBER	DESCRIPTION
1	1 PC	8N201-400	ASY, AIR-TO-WATER COOLER
2	1 PC	8N006-030	ASY, HEAT EXCHANGER
3	1 PC	8F001-405	WATER PUMP, AUX, BOSCH
4	1 PC	4CM055-020	RESERVOIR, AIR-TO-WATER SYSTEM
5	1 PC	7U133-500	1/2" X 90° MOLDED RUBBER HOSE
6	1 PC	7P750-503	3/4" TO 1/2" REDUCER BARB, 90°
7	4 FT	7U038-000	3/4" HEATER HOSE
8	2 PC	7U038-150	HOSE, 3/4" X 150° MOLDED ELBOW
9	1 PC	7U038-012	HOSE, 3/4" X 90°, 4" X 12" LEGS
10	1 PC	7P750-502	REDUCER, 3/4" BARB TO 1/2" BARB
11	2.5 FT	7U041-000	1/2" HEATER HOSE
12	1 PC	7P500-035	FITTING, 1/2 NPT X 3/4 BARB X 45°
13	1 PC	7P500-078	FITTING, 1/2 NPT X 3/4 BARB STRT

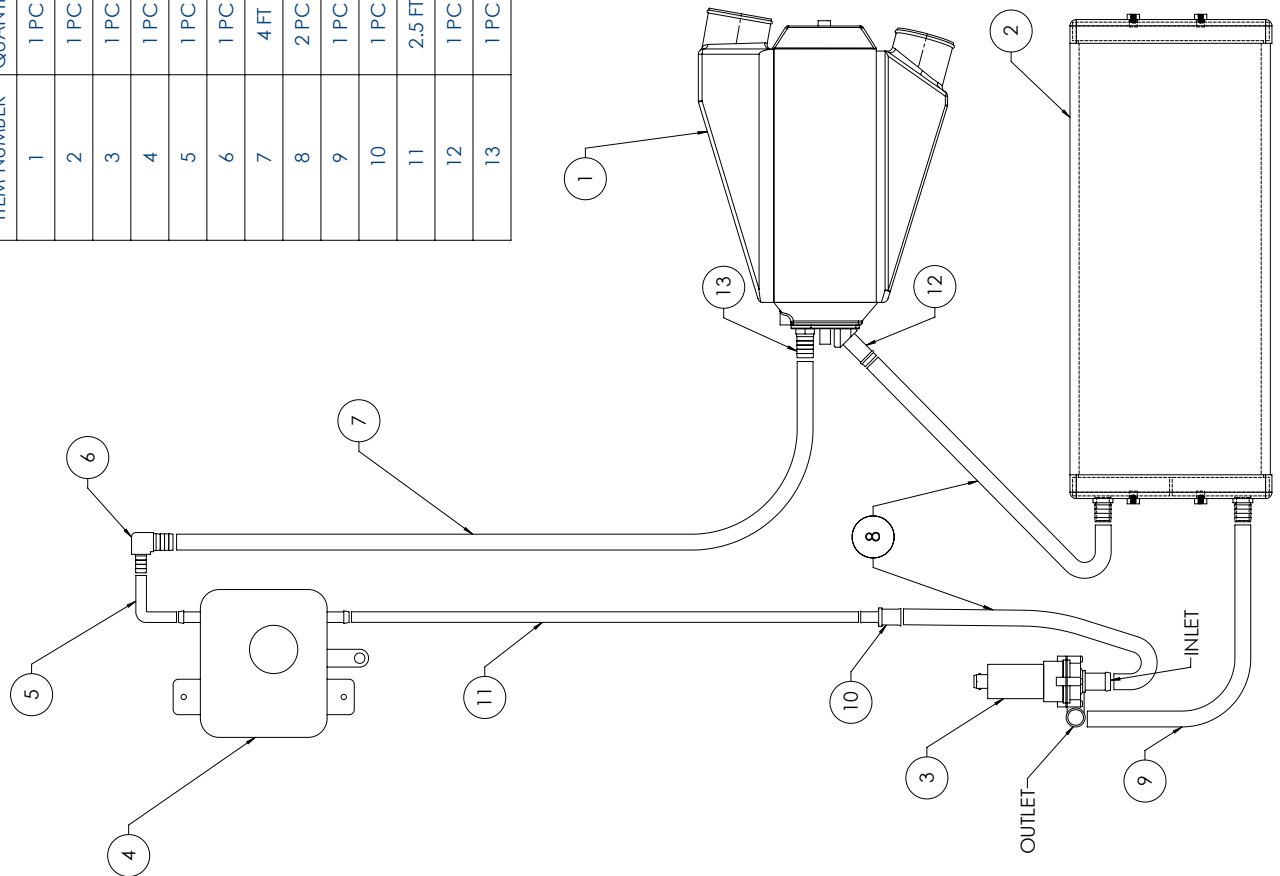

APPENDIX D. DIAGRAM, DISCHARGE TUBE ASSEMBLY

ITEM NUMBER	PART NUMBER	DESCRIPTION
1	7PS300-275	REDUCER SLEEVE, 3.00" TO 2.75"
2	4CM012-010	DISCH TUBE A, 15-17 CHALL
3	7PS300-301	BUMP SLEEVE, 3.00" X 3.00"
4	4CM112-020	ASY, DISCH TUBE B, 15-17 CHALL
5	7PS300-300	SLEEVE, 3.00" X 3.00"
6	8N201-400	ASY, CAC, 15-17 HEMI CAR
7	4CM012-030	DISCH SLEEVE C, 15-17 HEMI
8	4CM112-040	ASY, DISCH TUBE D, 15-17 HEMI
9	4CM012-050	DISCH SLEEVE E, 15-17 HEMI 6.4L

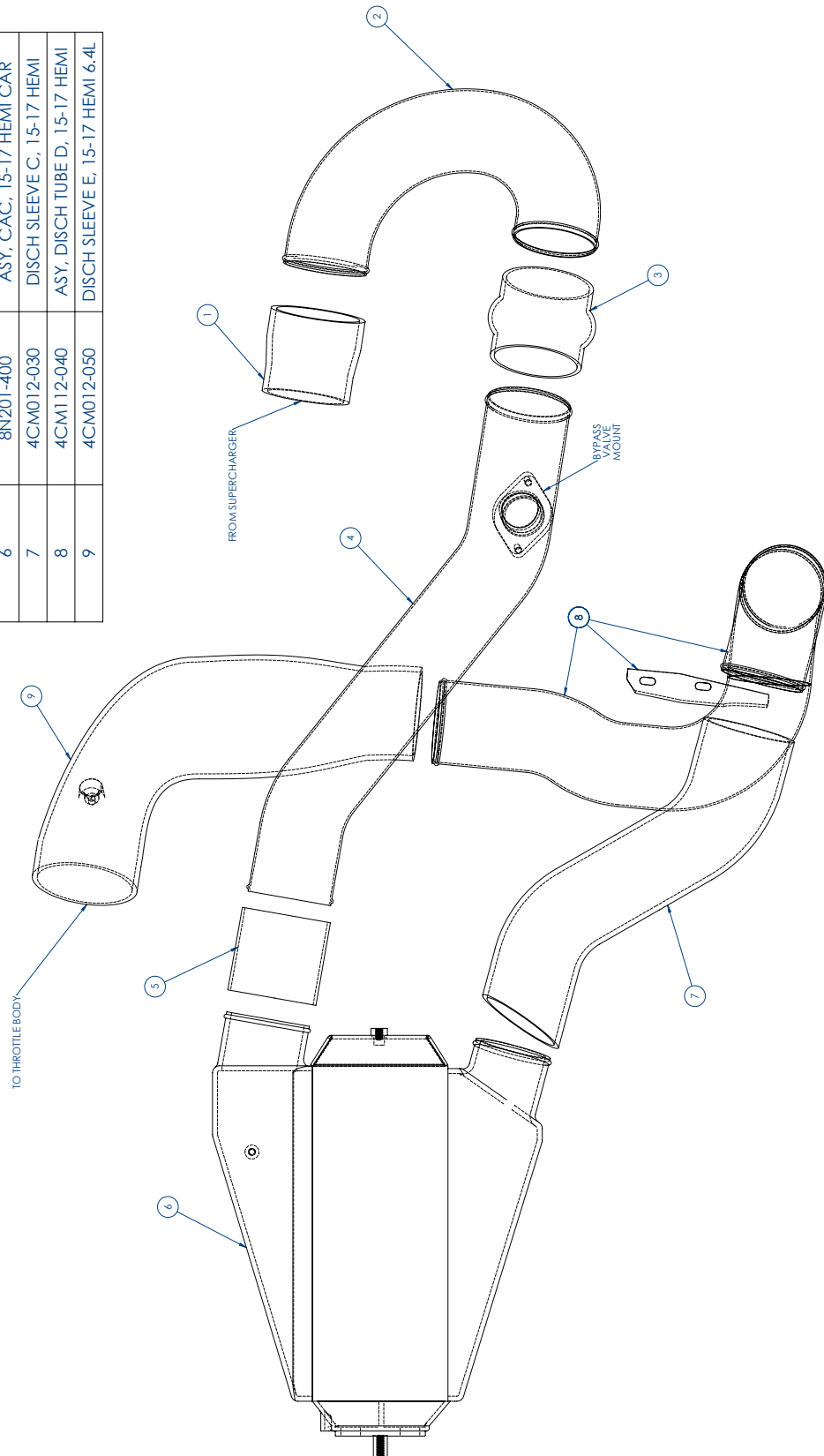



ENGINEERING, INC

1650 Pacific Avenue, Channel Islands, CA 93033-9901 • Phone (805) 247-0226
Fax: (805) 247-0669 • www.vortechsuperchargers.com • M-F 7:00 AM - 3:30 PM (PST)