

# Nissan 350Z/ Infinity G35

## Supercharger System Installation Instructions

2003-2006 Model Years

50 State Smog Legal per CARB EO #D-213-22/26

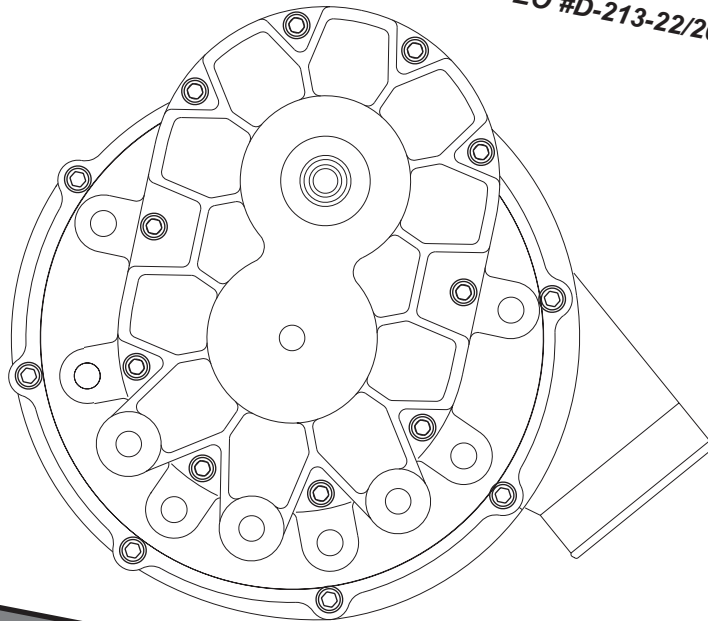

**ENGINEERING, LLC**

1650 Pacific Avenue, Channel Islands CA 93033-9901 • Phone: 805 247-0226  
Fax: 805 247-0669 • [www.vortechsuperchargers.com](http://www.vortechsuperchargers.com) • M-F 8:00AM - 4:30PM (PST)

# FOREWORD

This manual provides information on the installation, maintenance and service of the Vortech supercharger kit expressly designed for this vehicle. All information, illustrations and specifications contained herein are based on the latest product information available at the time of this publication. Changes to the manual may be made at any time without notice. Contact Vortech Engineering for any additional information regarding this kit and any of these modifications at (805) 247-0228 8:00am-4:30pm PST.



## Take note of the following before proceeding:

1. Proper installation of this supercharger kit requires general automotive mechanic knowledge and experience. Please browse through each step of this instruction manual prior to beginning the installation to determine if you should refer the job to a professional installer/technician. Please contact your dealer or Vortech Engineering for possible installers in your area.
2. This product was designed for use on stock (un-modified, OEM) vehicles. The PCM (computer), engine, transmission, drive axle ratios and tire O.D. must be stock. If the vehicle or engine has been modified in any way, check with Vortech prior to installation and use of this product.
3. Use only premium grade fuel with a minimum of 91 octane (R+M/2).
4. Always listen for any sign of detonation (knocking/pinging) and discontinue hard use (no boost) until the problem is resolved.
5. Vortech is not responsible for any clutch, transmission, drive-line or engine damage.

Exclusions from Vortech warranty coverage consideration includes, but not limited to:

1. Neglect, abuse, lack of maintenance, abnormal operation or improper installation.
2. Continued operation with an impaired vehicle or sub-system.
3. The combined use of Vortech components with other modifications such as, but not limited to, exhaust headers, aftermarket camshafts, nitrous oxide, third party PCM programming or other such changes.

## WARNING

- Extreme care must be taken when driving a supercharged vehicle with the stock clutch. If clutch slippage is detected, discontinue hard use. Vortech recommends replacing the stock clutch with a higher capacity unit if slippage occurs.
- Although this kit fits vehicles (*except G35 Sedan*) with an automatic, the transmission may not upshift at full throttle when driving in "D" (drive) mode. In order to shift at full throttle, the transmission must be in the "manual shift" mode and operated by the driver. Vortech makes no claims as to the reliability of the transmission with the supercharger installed.

©2007 VORTECH ENGINEERING, LLC

All rights reserved. No part of this publication may be reproduced, transmitted, transcribed, or translated into another language in any form, by any means without written permission of Vortech Engineering, LLC.

# TABLE OF CONTENTS

FOREWORD .....	ii
TABLE OF CONTENTS .....	iii
NOTICE .....	iv
TOOL & SUPPLY REQUIREMENTS .....	v
PARTS LIST - (2003-2004 Standard Engine Nissan 350Z, V-3) .....	vi
PARTS LIST - (2005 Standard Engine Nissan 350Z, V-3) .....	vii
PARTS LIST - (2003 Infiniti G35, 6-Speed, V-3) .....	viii
PARTS LIST - (2004 Infiniti G35, 6-Speed, V-3) .....	ix
PARTS LIST - (2005-2006 300HP (Rev-Up) 350Z/G35, V-3) .....	x
PARTS LIST - (2006 Standard Engine 350Z/G35, V-3) .....	xi
PARTS LIST - (2003-2004 Standard Engine Nissan 350Z, V-2) .....	xii
PARTS LIST - (2005 Standard Engine Nissan 350Z, V-2) .....	xiii
PARTS LIST - (2003 Infiniti G35, 6-Speed, V-2) .....	xiv
PARTS LIST - (2004 Infiniti G35, 6-Speed, V-2) .....	xv
PARTS LIST - (2005-2006 300HP (Rev-Up) 350Z/G35, V-2) .....	xvi
PARTS LIST - (2006 Standard Engine 350Z/G35, V-2) .....	xvii
1. PREPARATION/REMOVAL .....	1
2. OIL DRAIN LINE INSTALLATION .....	2
3. OIL FEED LINE INSTALLATION .....	3
4. THROTTLE BODY DUCTING INSTALLATION .....	4
5. SUPERCHARGER MOUNTING PLATE INSTALLATION..(2003-2005 Standard Output Engines) .....	6
6. SUPERCHARGER MOUNTING PLATE INSTALLATION (2005 and Later HO 300hp Engines) .....	8
7.1 FUEL MANAGEMENT UNIT (FMU) RECALIBRATION (2005 G35 Only) .....	10
7.2 FUEL MANAGEMENT UNIT (FMU) AND FUEL PUMP INSTALLATION .....	10
8. CHARGE COOLER INSTALLATION .....	12
9. SUPERCHARGER BYPASS VALVE INSTALLATION .....	13
10. '03-'05 STANDARD ENGINE TIMING CONTROLLER INSTALLATION .....	14
11. 2005 "REV-UP" AND 2006 TIMING CONTROLLER INSTALLATION .....	17
12. FINAL ASSEMBLY AND CHECK .....	18

# NOTICE

This product is protected by state common law, copyright and/or patent. All legal rights therein are reserved. The design, layout, dimensions, geometry, and engineering features shown in this product are the exclusive property of Vortech Engineering, LLC. This product may not be copied or duplicated in whole or part, abstractly or fundamentally, intentionally or fortuitously, nor shall any design, dimension, or other information be incorporated into any product or apparatus without prior written consent of Vortech Engineering, LLC.

# Nissan 350Z/Infinity G35

## Installation Instructions

***Congratulations on selecting the best performing and best backed automotive supercharger available today... the VORTECH® supercharger!***

Before beginning this installation, please read through this entire instruction booklet and the Street Supercharger System Owner's Manual (Race Owner's Manual for the Renegade kit) which includes the Limited Warranty Program, the Warranty Registration form and return envelope.

Vortech supercharger systems are performance improving devices. In most cases, increases in torque of 30-40% and horsepower between 45-55% can be expected with the boost levels specified by Vortech Engineering. **This product is intended for use on healthy, well maintained engines. Installation on a worn-out or damaged engine is not recommended and may result in failure of the engine as well as the supercharger. Vortech Engineering is not responsible for engine damage.**

Installation on new vehicles will not harm or adversely affect the break-in period so long as factory break-in procedures are followed.

***For best performance and continued durability, please take note of the following key points:***

1. Use only premium grade fuel **91 octane or higher** (R+M/2).
2. The engine must have stock compression ratio.
3. If the engine has been modified in any way, check with Vortech prior to using this product.
4. **Always listen for any sign of detonation (pinging) and discontinue hard use (no boost) until the problem is resolved.**
5. Perform an oil and filter change upon completion of this installation and prior to test driving your vehicle. Thereafter, always use a high grade SF rated engine oil or a high quality synthetic, and change the oil and filter at least every 3,000 miles. **Never attempt to extend the oil change interval beyond 3,000 miles, regardless of oil manufacturer's claims as potential damage to the supercharger may result.**
6. Before beginning installation, replace all spark plugs that are older than 1 year or 10,000 miles with original heat range plugs as specified by the manufacturer and reset timing to factory specifications (follow the procedures indicated within the factory repair manual and/or as indicated on the factory underhood emissions tag). **Do not use platinum spark plugs unless they are original equipment.** Change spark plugs every 15,000 miles and spark plug wires at least every 50,000 miles.

### **TOOL & SUPPLY REQUIREMENTS**

- Ø2.5" Hole Saw
- 1/8", 11/64" Drill Bits
- Drill Motor
- Stepless Clamp Crimping Pliers
- Seal Cutter
- Gasket Scraper
- Silicone RTV (Permatex Ultra Grey: 82194 or equivalent)
- Factory Repair Manual (Recommended)
- 3/8" Socket and Drive Set: SAE & Metric
- 1/2" Socket and Drive Set: SAE & Metric
- 3/8" NPT Tap and Handle
- Open End Wrenches: SAE & Metric
- Center Punch
- Springlock 5/16" Fuel Fitting Disconnect Tool
- 5 Quarts SH/CF Rated Quality Engine Oil
- Oil Filter and Wrench
- Flat #2 Screwdriver
- Phillips #2 Screwdriver
- Heavy Grease
- Silicone Sealer
- Drill Motor
- 1/8", 3/16" Drill Bits
- Hex Key Wrench Set
- Wire Strippers and Crimpers
- Utility Knife



***If it has been 20,000 miles or more since your vehicle's last spark plug change, then you will also need:***

- Spark plug socket
- NEW spark plugs



# 2003-2004 Standard Engine 350Z, V-3 SC

Part No. 4NZ218-010L

## PARTS LIST

**IMPORTANT:** Before beginning installation, verify that all parts are included in the kit. Report any shortages or damaged parts immediately.

PART NO.	DESCRIPTION	QTY.	PART NUMBER	DESCRIPTION	QTY.
2F339-040	V3 SC-TRIM ASY, CCW, 350Z	1	6Z020-140	LRG DIAPHRAGM,FLUORO	1
8N101-350	CHARGE AIR COOLER, 350Z	1	6Z030-150	BRACKET, FMU	1
4NZ110-033	MTG PLATE ASY 350Z	1	6Z040-160	PISTON, FMU	1
2A017-028	SPACER, .500" x .294"L	1	6Z050-191	FMU WASHER, 8:1 PLATED	1
2A017-029	SPACER, .500" x 1.175"L	2	6Z060-181	SHIM, FMU	1
2A017-103-110	SPACER, COG IDLER, 1.1"L 350Z	1	6Z070-030	FMU 8:1 RING SPACER	1
2A017-103-602	SPACER, 350Z MTG PLATE .602"L	1	6Z080-011	RETAINER, FMU SPRING GM 4.3	1
2A017-462	SPACER, IDLER 6-RIB .462"L	3	6Z090-010	SPRING, FMU GM 4.3	1
2A036-333	S/C PULLEY 3.33" 6-GROOVE	1	7C010-050	10-24 X .50 SHCS GR8 PLT	6
2A040-011	PULLEY RETAINER S/C	2	7C010-075	10-24 X 3/4 SHCS GR5 ZINC	4
2A046-795	BELT, K060795	1	7C024-025	10-24 X 1/4 PHILL HD	3
2D070-159	LARGE BEARING, EXTENDED DRIVE	2	7E010-075	#12 X 3/4" SHT METL SCRW HEX	2
2D070-171	JACKSHAFT, C5, H900	1	7P125-025	1/8 NPT X 5/32 HOSE 90°	1
4FA016-171	DUST COVER (IDLER PULLEY)	1	7P125-031	1/8NPT-90° 5/16 BARB	1
1210517	IDLER PULLEY, 6-RIB SMOOTH 2.5"	1	7P125-032	1/8NPT-STR,5/16 BARB	1
4GF016-160	PULLEY, 3" IDLER, RIBBED	1	7P156-082	5/32 TEE	1
4GR032-032	PULLEY, 32-TOOTH JKSHFT, DRIVEN	1	7P312-005	5/16 FEM FUEL CNCT STEEL	1
4GR116-300	IDLER ASY, 20mm BELT	1	7P312-007	FUEL FTG, 5/16 GM X 5/16 HSE	1
4NZ010-033	MTG PLATE, S/C, 350Z	1	7R004-001	STEPLESS CLAMP, 15.7-70	4
4NZ030-041	BRG HSG, 350Z	1	7U030-046	5/32" VACUUM LINE	7
7A312-152	5/16-18 x 1.5" SHCS	4	7U031-018	5/16 EFI FUEL HSE HI-PSR	2.5
7A375-100	3/8-16 x 1" HXHD	4	7U031-018	5/16 EFI FUEL HSE HI-PSR	1.25
7B375-075	3/8-24 x 3/4" GR8 HXHD BOLT	1	7U100-030	O-RING, FMU	1
7B375-150	3/8-24 x 1-1/2" HX CLS	1	7U100-096	ROLL PIN, 3/16x1/2, SS	1
7C012-040	12mm-1.75 x 40mm HXHD BOLT	1	4NZ101-068	FUEL PUMP ASSY, INLINE, 350Z	1
7C012-110	M12-1.75 x 110 HHCS	1	5W001-045	16-14 GA RING TERM .17" HOLE	1
7C060-020	M6-1.0 x 20mm HHCS	2	5W001-032	1/4" PLASTIC WIRE LOOM	120
7C060-025	M6-1.00 x 25mm HX	1	5W001-011	16-14 GA RING TERM .26" HOLE	1
7C060-070	M6-1.0 x 70 HXHD GR8.8 PLT	2	5W014-030	14GA STRD WIRE BLACK	0.5
7G010-175	12mm x 1.75mm NUT	1	7E010-075	#12 X 3/4" SHT METL SCRW HEX	2
7J006-093	6mm WASHER, PLATED	5	7P312-017	5/16" HOSE BARB TO M10 X 1.0	1
7J012-092	12mm WASHER, FLAT	1	7P312-082	5/16 TEE HOSE BARB	2
7K375-040	3/8"AN960 FLAT WASHER	6	7R003-027	ADEL CLAMP,1-11/16"	2
7U100-069	KEY, 3/16" SQUARE x .73" LONG	1	7R004-001	STEPLESS CLAMP, 15.7-70	8
7U100-073	KEY, 3/16" SQUARE x 1.375" LONG	1	7U031-018	5/16 EFI FUEL HSE HI-PSR	5.5
7U100-084	SNAP RING, V9	1	7U100-044	TIE WRAP, 4" NYLON	10
7X100-027	WAVE WASHER-LARGE (V-2)	1	7U100-055	TIE WRAP, 7.5" NYLON	5
7C060-017	M6-1.0 x 16mm BHCS	1	8F001-068	WALBRO INLINE FUEL PUMP, 68 GP	1
4NZ112-010	DISCHARGE ASSY, 350Z	1	5A001-351	TIMING CONTROL BOX, 350Z PROGR	1
4NZ010-020	BRKT, CLR MTG, 350Z	1	5W001-017	3/8" RING TERMINAL 12GA.	1
4NZ012-010	TUBE, S/C OUTLET, 350Z	1	7U375-001	VELCRO-HOOK 1" BLACK	0.22YD
4NZ012-030	TUBE, CLR OUTLET, 350Z	1	7U375-002	VELCRO-LATCH 1" BLACK	0.22YD
4NZ012-040	TUBE, COOLER UP PIPE, 350Z	1	7P156-082	5/32" TEE	1
4NZ012-060	TUBE, MAF OUTLET, 350Z	1	7P156-119	5/32" UNION (Ø.156"OD)	1
4NZ112-020	TUBE ASY, COOLER INLET, 350Z	1	5A001-350	TIMING CONTROL BOX, 350Z, RAW	1
4NZ112-050	TUBE ASY, MAF INLET, 350Z	1	4NZ112-035	INLET ASSY,SUPERCHARGER, G35	1
7A250-074	1/4-20 x 3/4" HXHD	2	7P625-016	5/8" HOSE UNION, BARBED ENDS	1
7J250-001	1/4"SAE WASHER	2	7P625-091	5/8" x 5/8" x 90° BARB ELBOW	1
7R002-040	#40 STAINLESS HOSE CLAMP	10	7U033-020	5/8" FUEL/PCV HOSE	30"
7R002-044	#44 SAE TYPE "F" SS HOSE CLAMP	2	8H040-035	AIR FILTER, 3.5" FLG x 3.0"L, OFFSET, G35	1
7R002-048	#48 SAE TYPE "F" SS HOSE CLAMP	4	4NZ020-010	NISSAN 350Z, G35 INST. MANUAL	1
7S250-200	2-1/2" x 2" SLEEVE	2	008110	SMALL SILVER DIE CUT DECAL	2
7S250-300	HOSE, HI-TEMP, 2.50"ID x 3.00"	2	008130	LICENSE PLATE FRAME, VORTECH	1
7S275-251	REDUCER, 2.75" TO 2.50"	2	008447	1 YR S/C STRT INFO PKG ASY VOR	1
7S300-200	3" x 2" SLEEVE	2	009035	S/C LUBE, BOTTLED, VORT 3-PACK	1
8D204-001	RACE BLOWOFF VALVE-BLUE	1			
8N010-070	BRACKET, PUMP-TO-TANK, MTG, LS1	2			
8N100-001	NYLON MOUNTING KIT	1			
7J006-093	6MM WASHER, PLATED	4			
7C060-016	M6 X 1.0 X 16 HXHD	4			
4NZ238-088	FMU w/LINES, w/SPRING, 350Z	1			
6Z010-101	FMU HOUSING (BLUE ANODIZED)	1			
6Z010-111	FMU VALVE BODY (BLUE ANODIZE)	1			
6Z010-131	COVER, FMU - GM 4.3	1			
6Z020-130	SML DIAPHRAGM,FLUORO	1			



# 2005 Standard Engine 350Z/G35\*, V-3 SC

Part No. 4NZ218-050L

## PARTS LIST

**IMPORTANT:** Before beginning installation, verify that all parts are included in the kit. Report any shortages or damaged parts immediately.

PART NO.	DESCRIPTION	QTY.	PART NUMBER	DESCRIPTION	QTY.
2F339-040	V3 SC-TRIM ASY, CCW, 350Z	1			
8N101-350	CHARGE AIR COOLER, 350Z	1			
4NZ110-033	MTG PLATE ASSEMBLY, 350Z*	1			
4NZ112-010	DISCHARGE ASSY, 350Z*	1			
4NZ238-078	FMU, 7:1 (W/6:1) W/LINES, W/SP	1			
6Z010-101	FMU HOUSING (BLUE ANODIZED)	1			
6Z010-111	FMU VALVE BODY (BLUE ANODIZE)	1			
6Z010-131	COVER, FMU - GM 4.3	1			
6Z020-130	SML DIAPHRAGM,FLUORO	1			
6Z020-140	LRG DIAPHRAGM,FLUORO	1			
6Z030-150	BRACKET, FMU	1			
6Z040-160	PISTON, FMU	1			
6Z050-161	FMU WASHER, 6:1/30LB. PLATED	1			
6Z060-181	SHIM, FMU	1			
6Z070-010	FMU 6:1 RING SPACER	1			
6Z080-011	RETAINER, FMU SPRING GM 4.3	1			
6Z090-010	SPRING, FMU GM 4.3	1			
7C010-050	10-24 X .50 SHCS GR8 PLT	6			
7C010-075	10-24 X 3/4 SHCS GR5 ZINC	4			
7C024-025	10-24 X 1/4 PHILL HD	3			
7E010-075	#12 X 3/4" SHT METL SCRW HEX	2			
7P125-025	1/8 NPT X 5/32 HOSE 90°	1			
7P125-031	1/8NPT-90° 5/16 BARB	1			
7P125-032	1/8NPT-STR,5/16 BARB	1			
7P156-082	5/32 TEE	1			
7P312-005	5/16 FEM FUEL CNCT STEEL	1			
7P312-007	FUEL FTG, 5/16 GM X 5/16 HSE	1			
7R004-001	STEPLESS CLAMP, 15.7-70	4			
7U030-046	5/32" VACUUM LINE	7			
7U031-018	5/16 EFI FUEL HSE HI-PSR	2.5			
7U031-018	5/16 EFI FUEL HSE HI-PSR	1.25			
7U100-030	O-RING, FMU	1			
7U100-096	ROLL PIN, 3/16x1/2, SS	1			
6Z050-211	FMU WASHER, 7:1 PLATED	1			
6Z070-060	FMU 7:1 RING SPACER	1			
4NZ101-068	FUEL PUMP ASSY, INLINE, 350Z*	1			
5A001-354	TIMING CONTROL BOX,05 G35 PROG	1			
5A001-350	TIMING CONTROL BOX, 350Z RAW	1			
5W001-017	12-10GA X 3/8" RING TERMINAL	1			
7P156-082	5/32 TEE	1			
7P156-119	5/32 UNION (+.156 O.D.)	1			
7U375-001	VELCRO-HOOK 1" BLACK	0.22YD			
7U375-002	VELCRO-LATCH 1"BLACK	0.22YD			
4NZ112-035	INLET ASSY,SUPERCHARGER, G35*	1			
4NZ101-010	SUPPORT PARTS ASSY, 05 G35 AUT	1			
7A250-101	1/4-20 x 1" HHCS	1			
7F250-021	1/4-20 NYLOCK NUT	1			
7J250-001	1/4"SAE WASHER	2			
7U032-020	HOSE, 3/8"ID PWRSTR	48"			
4NZ020-010	NISSAN 350Z, G35 INST. MANUAL	1			
008110	SMALL SILVER DIE CUT DECAL	2			
008130	LICENSE PLATE FRAME, VORTECH	1			
008447	1 YR S/C STRT INFO PKG ASY VOR	1			
009035	S/C LUBE, BOTTLED, VORT 3-PACK	1			

\*Not compatible with 2005 G35 6sp, 2005 G35 4dr Auto, 2005 350Z Track model or 2005 350Z Anniversary Z

\*\*See page "vi" for individual components



**ENGINEERING, LLC**

# 2003 Infiniti G35, 6-Speed, V-3 SC

Part No. 4NZ218-030L

## PARTS LIST

**IMPORTANT:** Before beginning installation, verify that all parts are included in the kit. Report any shortages or damaged parts immediately.

PART NO.	DESCRIPTION	QTY.	PART NUMBER	DESCRIPTION	QTY.
2F339-040	V3 SC-TRIM ASY, CCW, 350Z	1			
8N101-350	CHARGE AIR COOLER, 350Z	1			
5A001-353	TIMING CONTROL BOX,03 G35 PROG	1			
5A001-350	TIMING CONTROL BOX, 350Z RAW	1			
5W001-017	12-10GA X 3/8" RING TERMINAL	1			
7P156-082	5/32 TEE	1			
7P156-119	5/32 UNION (+.156 O.D.)	1			
7U375-001	VELCRO-HOOK 1" BLACK	0.22YD			
7U375-002	VELCRO-LATCH 1"BLACK	0.22YD			
4NZ110-033	MTG PLATE ASSEMBLY, 350Z*	1			
4NZ112-010	DISCHARGE ASSY, 350Z*	1			
4NZ238-088	FMU, 8:1, W/LINES, W/SPRING, 350Z*	1			
4NZ101-068	FUEL PUMP ASSY, INLINE, 350Z*	1			
4NZ112-035	INLET ASSY,SUPERCHARGER, G35*	1			
4NZ020-010	NISSAN 350Z, G35 INST. MANUAL	1			
008110	SMALL SILVER DIE CUT DECAL	2			
008130	LICENSE PLATE FRAME, VORTECH	1			
008447	1 YR S/C STRT INFO PKG ASY VOR	1			
009035	S/C LUBE, BOTTLED, VORT 3-PACK	1			

\*See page "vi" For Individual Components





# 2004 Infiniti G35, 6-Speed, V-3 SC

Part No. 4NZ218-020L

## PARTS LIST

**IMPORTANT:** Before beginning installation, verify that all parts are included in the kit. Report any shortages or damaged parts immediately.

PART NO.	DESCRIPTION	QTY.	PART NUMBER	DESCRIPTION	QTY.
2F339-040	V3 SC-TRIM ASY, CCW, 350Z	1			
8N101-350	CHARGE AIR COOLER, 350Z	1			
4NZ110-033	MTG PLATE ASSEMBLY, 350Z*	1			
4NZ112-010	DISCHARGE ASSY, 350Z*	1			
4NZ238-088	FMU, 8:1, W/LINES, W/SPRING, 350Z*	1			
4NZ101-068	FUEL PUMP ASSY, INLINE, 350Z*	1			
5A001-352	TIMING CONTROL BOX,04 G35 PROG	1			
5A001-350	TIMING CONTROL BOX, 350Z RAW	1			
5W001-017	12-10GA X 3/8" RING TERMINAL	1			
7P156-082	5/32 TEE	1			
7P156-119	5/32 UNION (+.156 O.D.)	1			
7U375-001	VELCRO-HOOK 1" BLACK	0.22YD			
7U375-002	VELCRO-LATCH 1"BLACK	0.22YD			
4NZ112-035	INLET ASSY,SUPERCHARGER, G35*	1			
4NZ020-010	NISSAN 350Z, G35 INST. MANUAL	1			
008110	SMALL SILVER DIE CUT DECAL	2			
008130	LICENSE PLATE FRAME, VORTECH	1			
008447	1 YR S/C STRT INFO PKG ASY VOR	1			
009035	S/C LUBE, BOTTLED, VORT 3-PACK	1			

\*See page "vi" For Individual Components



# 2005-2006 "Rev-Up" 350Z/G35, V-3 SC

Part No. 4NZ218-060L

## PARTS LIST

**IMPORTANT:** Before beginning installation, verify that all parts are included in the kit. Report any shortages or damaged parts immediately.

PART NO.	DESCRIPTION	QTY.	PART NUMBER	DESCRIPTION	QTY.
2F339-050	V3 SC-TRIM ASY, CCW, 350Z REV-UP	1			
8N101-350	CHARGE AIR COOLER, 350Z	1			
4NZ238-108	FMU, 10:1, W/LINES, NO/SPRING	1			
5A003-352	ECU, UNICHIP Q+, 350Z REV UP	1			
4NZ110-044	MTG PLATE ASSY, 300HP ENGINE	1			
2A017-029	SPACER, .500" x 1.175"L	2			
2A017-103-110	SPACER, COG IDLER, 1.1"L 350Z	1			
2A017-103-602	SPACER, 350Z MTG PLATE .602"L	1			
2A017-462	SPACER, IDLER 6-RIB .462"L	5			
2A036-312	S/C PULLEY 3.12" 6-GROOVE	1			
2A040-011	PULLEY RETAINER S/C	2			
2A046-935	BELT, 4060935-GOODYEAR	1			
2D070-159	LARGE BEARING, EXTENDED DRIVE	2			
2D070-171	JACKSHAFT, C5, H900	1			
4FA016-171	DUST COVER (IDLER PULLEY)	3			
4GF016-160	PULLEY, 3" IDLER-RIBBED	1			
1210517	IDLER, PLY. 2.5" SMOOTH, ASY	3			
4GR033-034	PULLEY, 34-TOOTH	1			
4GR116-300	IDLER ASY, 20mm BELT	1			
4NZ010-044	MTG PLATE, S/C 300HP	1			
4NZ030-041	BRG HSG, 350Z	1			
7A312-152	5/16-18 x 1.5" SHCS	4			
7A375-178	3/8-16 x 1-3/4" HXHD	4			
7B375-150	3/8-24 x 1-1/2" HXCL	2			
7C012-040	12mm-1.75 x 40mm HXHD BOLT	3			
7C012-110	M12-1.75 x 110 HHCS	1			
7C012-020	M6-1.0 x 20mm HHCS	3			
7C060-070	M6-1.0 x 70 HXHD GR8.8 PLT	2			
7G010-175	12mm x 1.75 NUT	1			
7J006-093	6mm WASHER, PLATED	5			
7J012-092	12mm WASHER, FLAT	1			
7K375-040	3/8"AN960 FLAT WASHER	6			
7U100-073	KEY, 3/16" SQUARE x 1.375"LONG	2			
7U100-084	SNAP RING, V9	1			
7X100-027	WAVE WASHER-LARGE (V-2)	1			
2017-881-01	SPACER, .875 OD X .532 LONG	4			
8F101-350	RELAY ASSY, 350Z FUEL PUMP	1			
5W001-005	3/8" PLASTIC WIRE LOOM	8			
5W001-010	16-14GA FEMALE SLIDE INSULATED	2			
5W001-016	RELAY,BOSCH	1			
5W001-040	12-10GA FEMALE SLIDE INSULATED	2			
5W001-046	16-14 GA RING TERM .33" HOLE	2			
5W001-054	16 GA FUSE HOLDER WITH WIRE	1			
5W014-010	14GA STRD WIRE RED, UL1015	7			
5W014-030	14GA STRD WIRE BLACK	1			
5W014-030	14GA STRD WIRE BLACK	7			
4NZ112-010	DISCHARGE ASSY, 350Z*	1			
4NZ101-068	FUEL PUMP ASSY, INLINE, 350Z*	1			
4NZ112-035	INLET ASSY,SUPERCHARGER, G35*	1			
4NZ101-010	SUPPORT PARTS ASSY, 05 G35 AUT**	1			
4NZ020-010	NISSAN 350Z, G35 INST. MANUAL	1			
008110	SMALL SILVER DIE CUT DECAL	2			
008130	LICENSE PLATE FRAME, VORTECH	1			
008447	1 YR S/C STRT INFO PKG ASY VOR	1			
009035	S/C LUBE, BOTTLED, VORT 3-PACK	1			

\*See page "vi" for Individual Components

\*\*See page "vii" for Individual Components



# 2006 Standard Engine 350Z/G35, V-3 SC

Part No. 4NZ218-070L

## PARTS LIST

**IMPORTANT:** Before beginning installation, verify that all parts are included in the kit. Report any shortages or damaged parts immediately.

PART NO.	DESCRIPTION	QTY.	PART NUMBER	DESCRIPTION	QTY.
2F339-040	V3 SC-TRIM ASY, CCW, 350Z	1			
8N101-350	CHARGE AIR COOLER, 350Z	1			
4NZ238-108	FMU, 10:1, W/LINES, NO/SPRING	1			
5A003-350	ECU, UNICHIP Q+, 350Z STD ENG	1			
8F101-350	RELAY ASSY, 350Z FUEL PUMP***	1			
4NZ101-010	SUPPORT PARTS ASSY, 05 G35 AUT**	1			
4NZ101-068	FUEL PUMP ASSY, INLINE, 350Z*	1			
4NZ110-033	MTG PLATE ASSEMBLY, 350Z*	1			
4NZ112-010	DISCHARGE ASSY, 350Z*	1			
4NZ112-035	INLET ASSY,SUPERCHARGER, G35*	1			
4NZ020-010	NISSAN 350Z, G35 INST. MANUAL	1			
009035	S/C LUBE, BOTTLED, VORT 3-PACK	1			
008110	SMALL SILVER DIE CUT DECAL	2			
008130	LICENSE PLATE FRAME, VORTECH	1			
008447	1 YR S/C STRT INFO PKG ASY VOR	1			

\*See page "vi" for Individual Components

\*\*See page "vii" for Individual Components

\*\*\*See page "x" for individual components



# 2003-2004 Standard Engine 350Z, V-2 SQ

Part No. 4NZ218-010SQ

## PARTS LIST

**IMPORTANT:** Before beginning installation, verify that all parts are included in the kit. Report any shortages or damaged parts immediately.

PART NO.	DESCRIPTION	QTY.	PART NUMBER	DESCRIPTION	QTY.
<b>2E229-030</b>	<b>V2SQ ASY, 350Z SATIN</b>	<b>1</b>			
4GR033-028	S/C PULLEY, 28-TOOTH, C5	1			
2A042-075	BELT, GATES 600-8MGT-20	1			
<b>8N101-350</b>	<b>CHARGE AIR COOLER, 350Z</b>	<b>1</b>			
<b>4NZ110-033</b>	<b>MTG PLATE ASY 350Z*</b>	<b>1</b>			
<b>4NZ130-026</b>	<b>OIL FEED LINE ASY, 350Z</b>	<b>1</b>			
7P125-004	1/8"NPT 90° x -4 JIC FTG	1			
7P125-005	1/8"NPT STR. x -4 JIC FTG	1			
7P125-034	1/8"NPT x 1/8"NPT STRT T	1			
7P125-125	FTG, 1/8"NPT FEM x 1/8"BSPT MALE	1			
7U100-055	TIE-WRAP, 6" NYLON	5			
7U250-000-360	OIL FEED HOSE, 36" -4 STRT	1			
<b>4NZ130-036</b>	<b>OIL DRAIN LINE ASY, 350Z</b>	<b>1</b>			
7P375-017	3/8"NPT x 1/2" BEADED HSE BRB	1			
7R001-008	#8 STNLS HOSE CLAMP	2			
7T560-001	CUTTER, 9/16" ROTABROACH	1			
7T560-002	ARBOR, ROTABROACH	1			
7U030-036	1/2" OIL DRAIN HOSE	1.5'			
7U100-066	TIE-WRAP, 11" NYLON	5			
<b>4NZ112-010</b>	<b>DISCHARGE ASY, 350Z*</b>	<b>1</b>			
<b>4NZ112-035</b>	<b>INLET ASY, 350Z</b>	<b>1</b>			
7P625-016	5/8" HOSE UNION, BARBED ENDS	1			
7P625-091	5/8" x 5/8" x 90° BARB ELBOW	1			
7U033-020	5/8" FUEL/PCV HOSE	30"			
8H040-350	AIR FILTER, 3.5" FLG x 4.5"L, OFFSET	1			
<b>4NZ238-088</b>	<b>FMU w/LINES, w/SPRING, 350Z*</b>	<b>1</b>			
<b>4NZ101-068</b>	<b>FUEL PUMP ASY, INLINE, 350Z*</b>	<b>1</b>			
<b>5A001-351</b>	<b>TIMING CONTROL BOX, 350Z*</b>	<b>1</b>			
<b>4NZ020-010</b>	<b>NISSAN 350Z, G35 INST. MANUAL</b>	<b>1</b>			
<b>008110</b>	<b>SMALL SILVER DIE CUT DECAL</b>	<b>2</b>			
<b>008130</b>	<b>LICENSE PLATE FRAME, VORTECH</b>	<b>1</b>			
<b>008444</b>	<b>3 YR S/C STRT INFO PKG ASY VOR</b>	<b>1</b>			

\*See page "vi" for individual components



# 2005 Standard Engine 350Z/G35\*, V-2 SQ

Part No. 4NZ218-050SQ

## PARTS LIST

**IMPORTANT:** Before beginning installation, verify that all parts are included in the kit. Report any shortages or damaged parts immediately.

PART NO.	DESCRIPTION	QTY.	PART NUMBER	DESCRIPTION	QTY.
2E229-030	V2SQ ASY, 350Z SATIN***	1\			
8N101-350	CHARGE AIR COOLER, 350Z	1			
4NZ110-033	MTG PLATE ASY 350Z**	1			
4NZ130-026	OIL FEED LINE ASY, 350Z***	1			
4NZ130-036	OIL DRAIN LINE ASY, 350Z***	1			
4NZ112-010	DISCHARGE ASY, 350Z**	1			
4NZ112-035	INLET ASY, 350Z***	1			
5A001-354	TIMING CONTROL BOX, 350Z****	1			
4NZ238-078	FMU, 7:1 (W/6:1) W/LINES, W/SP****	1			
4NZ101-068	FUEL PUMP ASSY, INLINE, 350Z**	1			
4NZ101-010	SUPPORT PARTS ASY, '05 G35 AUTO****	1			
4NZ020-010	NISSAN 350Z, G35 INST. MANUAL	1			
008110	SMALL SILVER DIE CUT DECAL	2			
008130	LICENSE PLATE FRAME, VORTECH	1			
008444	3 YR S/C STRT INFO PKG ASY VOR	1			

\* Not compatible with 2005 G35 6sp, 2005 G35 4dr Auto, 2005 350Z Track model or 2005 350Z Anniversary Z

\*\*See page "vi" for individual components

\*\*\*See page "xii" for individual components

\*\*\*\*See page "vii" for individual components



ENGINEERING, LLC

# 2003 Infiniti G35, 6-Speed, V-2 SQ

Part No. 4NZ218-030SQ

## PARTS LIST

**IMPORTANT:** Before beginning installation, verify that all parts are included in the kit. Report any shortages or damaged parts immediately.

PART NO.	DESCRIPTION	QTY.	PART NUMBER	DESCRIPTION	QTY.
2E229-030	V2SQ ASY, 350Z SATIN***	1			
8N101-350	CHARGE AIR COOLER, 350Z	1			
4NZ110-033	MTG PLATE ASY 350Z*	1			
4NZ130-026	OIL FEED LINE ASY, 350Z*	1			
4NZ130-036	OIL DRAIN LINE ASY, 350Z*	1			
4NZ112-010	DISCHARGE ASY, 350Z*	1			
4NZ112-035	INLET ASY, G35*	1			
5A001-353	TIMING CONTROL BOX, '03 G35*	1			
4NZ101-068	FUEL PUMP ASSY, INLINE, 350Z*	1			
4NZ238-088	FMU w/LINES, w/SPRING, 350Z*	1			
4NZ020-010	NISSAN 350Z, G35 INST. MANUAL	1			
008110	SMALL SILVER DIE CUT DECAL	2			
008130	LICENSE PLATE FRAME, VORTECH	1			
008444	3 YR S/C STRT INFO PKG ASY VOR	1			

\*See page "vi" for individual components

\*\*\*See page "xii" for individual components



ENGINEERING, LLC

# 2004 Infiniti G35, 6-Speed, V-2 SQ

Part No. 4NZ218-020SQ

## PARTS LIST

**IMPORTANT:** Before beginning installation, verify that all parts are included in the kit. Report any shortages or damaged parts immediately.

PART NO.	DESCRIPTION	QTY.	PART NUMBER	DESCRIPTION	QTY.
2E229-030	V2SQ ASY, 350Z SATIN****	1			
8N101-350	CHARGE AIR COOLER, 350Z	1			
4NZ110-033	MTG PLATE ASY 350Z*	1			
4NZ130-026	OIL FEED LINE ASY, 350Z*	1			
4NZ130-036	OIL DRAIN LINE ASY, 350Z*	1			
4NZ112-010	DISCHARGE ASY, 350Z*	1			
4NZ112-035	INLET ASY, G35*	1			
5A001-352	TIMING CONTROL BOX, '04 G35***	1			
4NZ101-068	FUEL PUMP ASSY, INLINE, 350Z*	1			
4NZ238-088	FMU w/LINES, w/SPRING, 350Z*	1			
4NZ020-010	NISSAN 350Z, G35 INST. MANUAL	1			
008110	SMALL SILVER DIE CUT DECAL	2			
008130	LICENSE PLATE FRAME, VORTECH	1			
008444	3 YR S/C STRT INFO PKG ASY VOR	1			

\*See page "vi" for individual components

\*\*See page "vii" for individual components

\*\*\*See page "ix" for individual components

\*\*\*\*See page "xii" for individual components



# 2005-2006 "Rev-Up" 350Z/G35, V-2 SQ

Part No. 4NZ218-060SQ

## PARTS LIST

**IMPORTANT:** Before beginning installation, verify that all parts are included in the kit. Report any shortages or damaged parts immediately.

PART NO.	DESCRIPTION	QTY.	PART NUMBER	DESCRIPTION	QTY.
2E229-120	V2SQ ASY, 300HP 350Z SATIN	1			
4GR033-032	PULLEY, SC, 20mm 32T	1			
2A042-070	BELT, GATES 560-8MGT-20	1			
4NZ238-108	FMU 10:1, w/LINES, NO/SPRING, 350Z	1			
4NZ101-068	FUEL PUMP ASSY, INLINE, 350Z*	1			
5A003-352	ECU, UNICHIP Q+, 350Z REV UP	1			
4NZ110-044	MTG PLATE ASY 300HP*	1			
4NZ130-036	OIL DRAIN LINE ASY, 350Z*	1			
8N101-350	CHARGE AIR COOLER, 350Z*	1			
4NZ112-010	DISCHARGE ASY, 350Z*	1			
4NZ112-035	INLET ASY, G35*	1			
4NZ101-010	SUPPORT PARTS ASY, '05 G35 AUTO***	1			
8F101-350	RELAY ASY, 350Z FUEL PUMP****	1			
4NZ130-026	OIL FEED LINE ASY, 350Z*	1			
4NZ020-010	NISSAN 350Z, G35 INST. MANUAL	1			
008110	SMALL SILVER DIE CUT DECAL	2			
008130	LICENSE PLATE FRAME, VORTECH	1			
008444	3 YR S/C STRT INFO PKG ASY VOR	1			

\*See page "vi" for individual components

\*\*See page "x" for individual components

\*\*\*See page "vii" for individual components

\*\*\*\*See page "x" for individual components





# 2006 Standard Engine 350Z/G35, V-2 SQ

Part No. 4NZ218-070SQ

## PARTS LIST

**IMPORTANT:** Before beginning installation, verify that all parts are included in the kit. Report any shortages or damaged parts immediately.

PART NO.	DESCRIPTION	QTY.	PART NUMBER	DESCRIPTION	QTY.
2E229-030	V2SQ ASY, 350Z SATIN*	1			
8N101-350	CHARGE AIR COOLER, 350Z	1			
4NZ238-108	FMU 10:1, w/LINES, NO/SPRING, 350Z	1			
4NZ101-068	FUEL PUMP ASSY, INLINE, 350Z**	1			
5A003-350	ECU, UNICHIP Q+, 350Z STD ENGINE	1			
4NZ110-033	MTG PLATE ASY 350Z**	1			
4NZ130-036	OIL DRAIN LINE ASY, 350Z**	1			
4NZ112-010	DISCHARGE ASY, 350Z**	1			
4NZ112-035	INLET ASY, G35**	1			
4NZ101-010	SUPPORT PARTS ASY, '05 G35 AUTO***	1			
8F101-350	RELAY ASY, 350Z FUEL PUMP****	1			
4NZ130-026	OIL FEED LINE ASY, 350Z**	1			
4NZ020-010	NISSAN 350Z, G35 INST. MANUAL	1			
008110	SMALL SILVER DIE CUT DECAL	2			
008130	LICENSE PLATE FRAME, VORTECH	1			
008444	3 YR S/C STRT INFO PKG ASY VOR	1			

\*See page "xii" for individual components

\*\*See page "vi" for individual components

\*\*\*See page "vii" for individual components

\*\*\*\*See page "x" for individual components

This Page Left Intentionally Blank

## 1. PREPARATION/REMOVAL

- A. Open doors (*to retract windows*) and disconnect the battery negative cable. Close doors.
- B. Remove the strut tower brace if equipped (*optional*).
- C. Remove the plastic engine cover and set aside.
- D. Remove the valve cover breather hose from the factory air inlet duct. Remove the air filter and all ducting up to the throttle body. Unplug the MAF (*mass air flow sensor*) and remove it from the air filter housing. Set it aside for later use along with its O-ring.
- E. Remove the splash pan from the bottom of the vehicle and set aside.
- F. Loosen the accessory drive belt tensioner idler center nut. From underneath the vehicle, turn the tensioner screw counter-clockwise until it stops. Remove the accessory drive belt.
- G. Remove and discard the two brackets securing the large wiring loom on the top of the engine.
- H. Remove the bracket (*if equipped*) securing the 5/8" I.D. coolant hose to the front of the engine.
- I. Remove and set aside the driver's side 12mm screw for later use. (See *Fig. 1-b*.)
- J. Remove the two engine cover screws from the positions shown. (See *Fig. 1-a*.)
- K. **350Z:** Remove the small engine air inlet duct that protrudes through the radiator core support.
- L. From underneath the vehicle, remove and discard the power steering cooler brackets located in front of the radiator.
- M. **350Z Convertibles only:** Locate and remove the chassis vibration damper and mount on the driver's side frame rail next to the sway bar mount. This provides a path for Charge Air Cooler ducting.

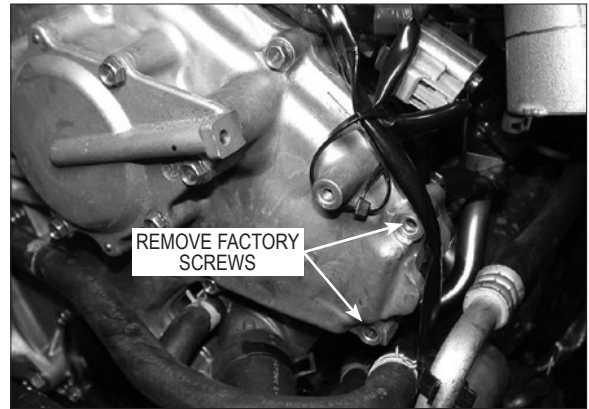

*Fig. 1-a*

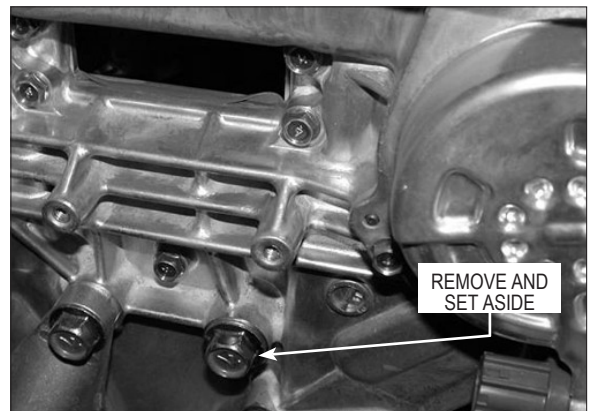

*Fig. 1-b*

## 2. OIL DRAIN LINE INSTALLATION

(Engine oil-fed kits only. Applications with V-3 Superchargers skip ahead to step 4)

**NOTE:** It is recommended that the lower oil pan be removed so that any chips from the following procedure can be cleaned up. To do this, a seal cutter and silicone RTV (Permatex ultra grey: 82194 or equivalent) are required.

- A. Drain the engine oil.
- B. Remove the steel oil pan (*optional*).
- C. To provide an oil drain for the supercharger, it is necessary to make a hole in the driver's side of the aluminum upper oil pan. Find the proper location and center-punch the hole. (See Fig. 2-a.)
- D. Access to the oil drain location is restricted so a low profile or right-angle drill may be necessary.
- E. Drill a 1/8" hole at the center location. Use the supplied 9/16" cutter to enlarge the pilot hole making sure to break through easily (*if the oil pan has not been removed*) so that the cutout does not fall into the pan.
- F. Thread the hole with a 3/8"NPT tap to approximately 1/2" deep or until the fitting can be started. Pack the flutes of the tap with grease to minimize the amount of debris that gets into the engine. Access is restricted so inserting the tap in a socket and then using a ratchet to rotate it is helpful.
- G. Thoroughly clean the threaded area and the interior of the engine. Apply a small amount of silicone sealer to the new threads. Apply more sealer to the 3/8"NPT hose fitting and secure in the hole. Make sure a seal is formed all around the fitting.
- H. If necessary, reinstall the oil pan. Clean off the old sealant and any oil from both surfaces, apply a .2" (5mm) wide bead of silicone RTV, install the pan within five minutes and torque the screws to 74-82 in-lbs (8.3-9.3 N-m) in a rotating sequence.
- I. Wait at least 30 minutes before refilling the engine with oil.



Fig. 2-a

### 3. OIL FEED LINE INSTALLATION

(Engine oil-fed kits only. Applications with V-3 Superchargers skip ahead to step 4)

- A. Remove the oil pressure sending unit located in front of the oil filter.
- B. Using engine oil on the threads, install the adapter into the engine block. Install the TEE into the adapter and tighten. Reinstall the sending unit into the TEE. Install 1/8"NPT to #4 90° fitting onto the TEE and point it toward the driver's side of the vehicle. (See *Fig. 3-a.*)
- C. Install a new filter and refill with fresh oil.



*Fig. 3-a*

#### 4. THROTTLE BODY DUCTING INSTALLATION

- A. Use the supplied hose union to attach the supplied 5/8" hose to the engine breather hose that was disconnected from the factory air-inlet duct.
- B. Attach the MAF to the supplied duct using the supplied 6mm hardware. The bend in the duct should point the same way as the plug on the MAF. Ensure the MAF O-ring is present.
- C. Using the supplied 3" tube and sleeves, attach the MAF to the throttle body. Plug in the MAF electrical connector.
- D. Install a 2.75" to 2.5" reducer onto the end of the duct. (See Fig. 4-a.)



Fig. 4-a

- E. Install the cast intermediate duct into the vehicle (see Fig. 4-b) and then slide it up into the reducer sleeve. The duct should be routed between the flexible A/C line and the frame with the bent end pointed down. (See Fig. 4-c.)
- F. Install and tighten clamps on each connection. (These may need to be loosened after the supercharger is installed to improve the fit.)



Fig. 4-b

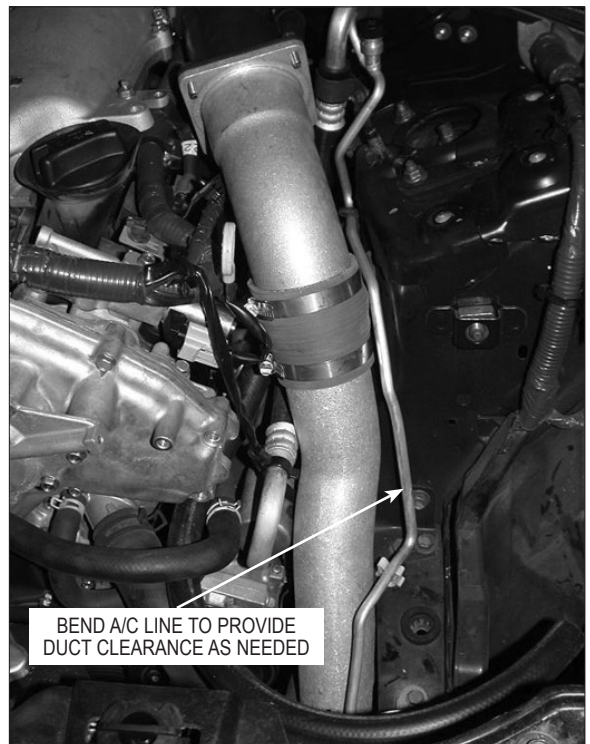

Fig. 4-c / (350Z)



#### 4. THROTTLE BODY DUCTING INSTALLATION, cont'd

- G. Install the air filter into the hole in the radiator core support so that it can later be attached to the supercharger inlet.
- H. Install the supplied 5/8" x 90° hose barb fitting into the hole in the base of the air filter. (See Fig. 4-d.)
- I. Trim the 5/8" hose and attach it to the fitting installed in the air filter. Make sure that the hose is long enough to clear the supercharger and bracket, but not so long as to kink.



Fig. 4-d / (G35)



Fig. 4-e

## 5. SUPERCHARGER MOUNTING PLATE INSTALLATION..(2003-2006 Standard Output Engines Only.) ( For 2005 and Later "Rev-Up" Engines, Skip to Section 6.)

**NOTE:** 2003-2005 standard output engine only. (For 2005 and later high-output 300hp engines, skip to Section 6.)

- A. (Non oil fed applications skip this step) Install the supplied  $\text{\O}1/2"$  fabric-braid oil drain line onto the supercharger fitting and tighten the supplied hose clamp.
- B. (Non oil fed applications skip this step) Install the supplied  $1/8"$ NPT x -4 straight fitting into the supercharger oil feed nozzle using motor oil on the threads. Attach the supplied oil feed hose to the fitting and tighten.

**NOTE:** Use clean oil on the pipe (tapered) threads. Teflon tape or sealant is not recommended as it may loosen and cause blockage of the small oil feed orifice resulting in supercharger failure.

- C. Install the six mounting screws and washers through the mounting plate in the positions shown. (See Fig. 5-a.)
- D. Install the supercharger onto the mounting plate and install and tighten the four  $3/8"$  x 1" screws and washers.
- E. Install the supplied gilmer (toothed) belt around the pulleys on the mounting plate assembly. (See Fig. 5-b.)
- F. Install the four supplied spacers onto their respective screws. (See Fig. 5-b.) A small dab of sealant between the spacer and the mounting plate may help retain them during the following steps.
- G. Position the supercharger mounting plate assembly in front of the engine and start all of the mounting screws.
- H. Make sure that the coolant hose is routed in the groove on the back of the supercharger mounting plate.
- I. (Non oil fed Applications skip this step) Verify that the oil drain hose is routed as smoothly as possible and connect it to the fitting on the oil pan. Tighten a hose clamp on this connection. Secure the oil drain hose and the A/C line away from the A/C pulley with zip-ties. Trim drain hose length if necessary.

**NOTE:** Oil in the supercharger is gravity drained to the oil pan. Trim the supplied oil drain hose as necessary so that it is continuously sloping down towards the oil pan. Avoid dips, kinks, etc.

- J. (Non oil fed Applications skip this step) Route the oil feed hose outside the driver's side frame rail and then to the fitting installed near the oil filter and tighten. Use the supplied zip-ties to secure.
- K. Tighten all of the mounting plate screws.
- L. Install the air filter onto the supercharger inlet and tighten the clamp.

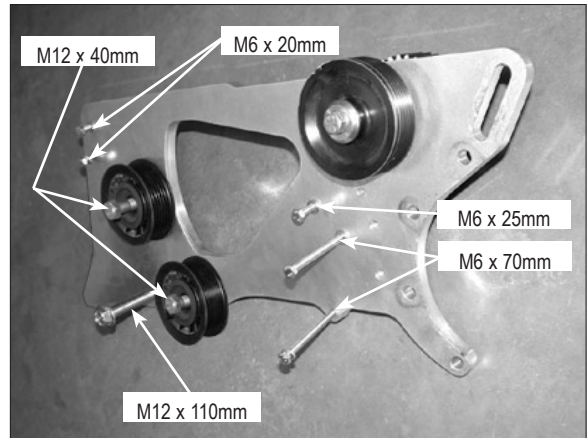

Fig. 5-a

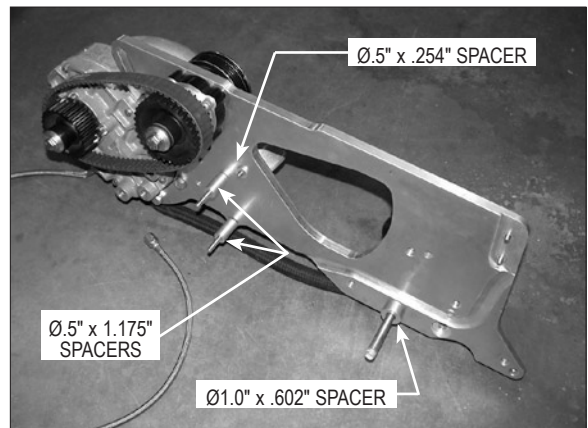

Fig. 5-b

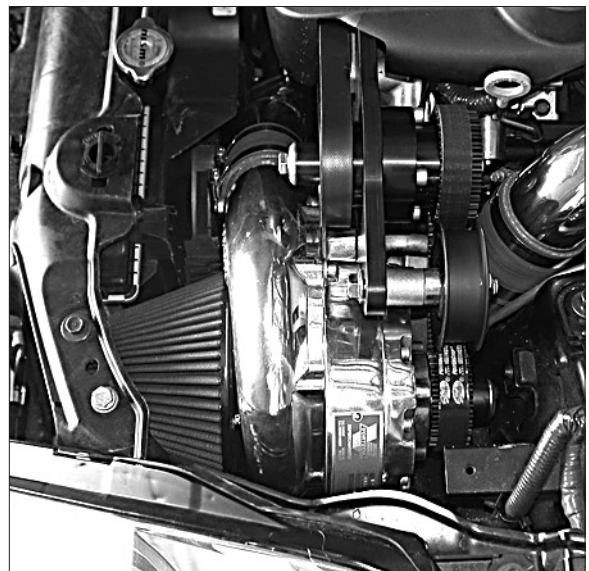
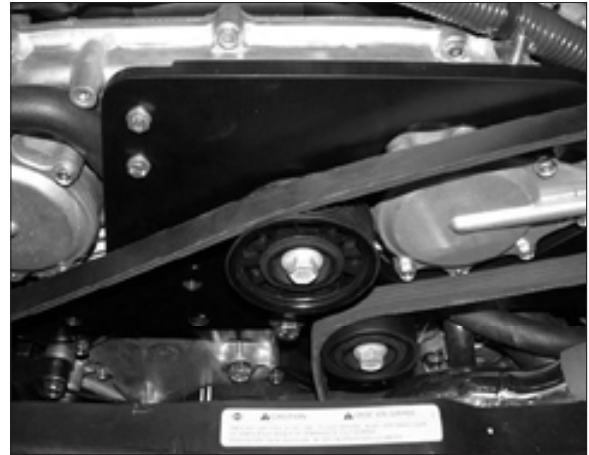

Fig. 5-c



**5. SUPERCHARGER MOUNTING PLATE INSTALLATION..(2003-2006 Standard Output Engines Only.) ( For 2005 and Later “Rev-Up” Engines, Skip to Section 6.), cont’d**

- M. Install the idlers in the positions shown in *Fig. 5-d*. Make sure that the 50mm screw (*longer*) is installed through the top idler.
- N. Using the 12mm screw set aside in *Step 1*, install the aluminum idler with the bearing retaining snap ring pointed towards the rear of the vehicle. The screw should pass through the idler, a pilot spacer, the 1.1" spacer and the supercharger mounting plate. Install the supplied nut and washer on the end of the screw and tighten the idler so that the gilmer belt is snug. (See *Fig. 5-c*.)
- O. Install the supplied accessory drive belt. Tighten the belt tensioner until the belt is tight. Tighten the center nut on the belt tensioner idler. (See the *Figs. 5-d, 5-e*.)
- P. (Applies to non oil fed applications only) Secure the remote drain hose away from the belt and other hoses using tie wraps.



*Fig. 5-d*

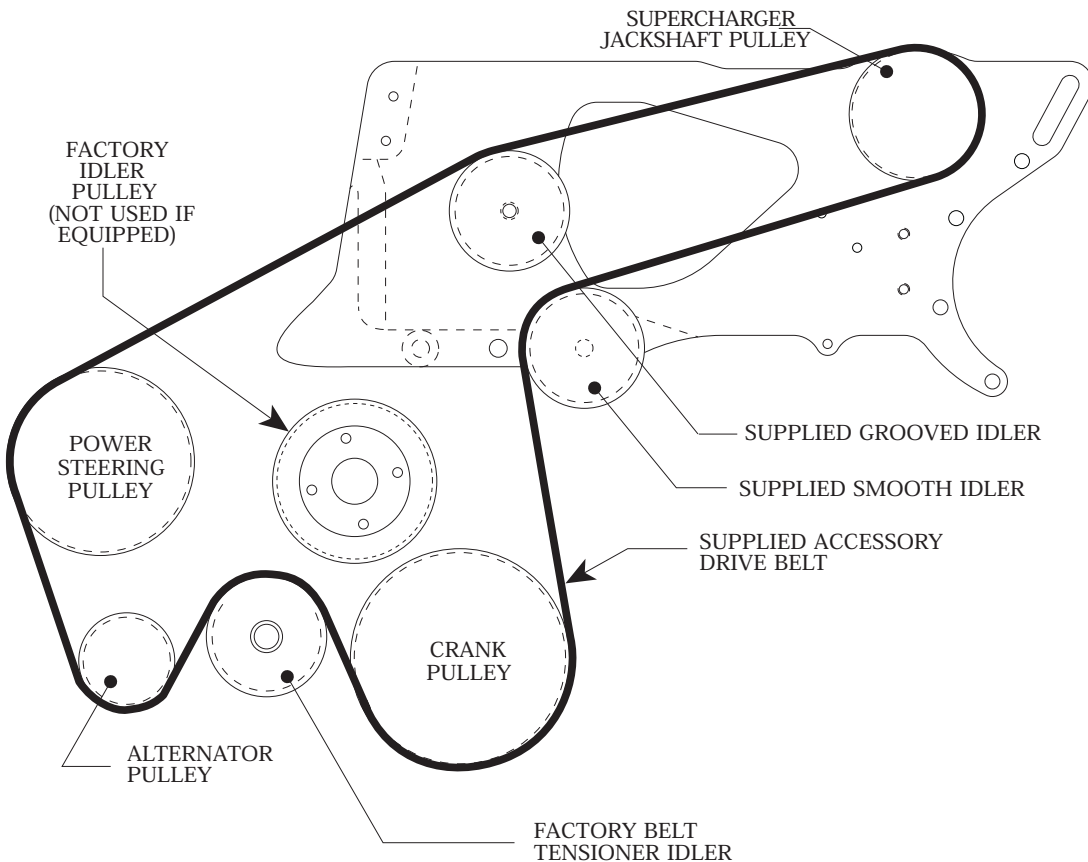

*Fig. 5-e / Accessory Drive Belt Routing*

## 6. SUPERCHARGER MOUNTING PLATE INSTALLATION (2005 and Later "Rev-Up" Engines)

- A. Remove the wire loom push pins and re-route the wires around the outside (driver's side) of the sheet metal bracket. (See Fig. 6-a.)
- B. (Non oil fed applications skip this step) Install the supplied  $\text{\O}1/2"$  fabric-braid oil drain line onto the supercharger fitting and tighten the supplied hose clamp.
- C. (Non oil fed applications skip this step) Install the supplied  $1/8"$ NPT x -4 straight fitting into the supercharger oil feed nozzle using motor oil on the threads. Attach the supplied oil feed hose to the fitting and tighten.

**NOTE:** Use clean oil on the pipe (tapered) threads. Teflon tape or sealant is not recommended as it may loosen and cause blockage of the small oil feed orifice resulting in supercharger failure.

- D. Install the mounting plate to engine screws through the mounting plate in the position shown. (See Fig. 6-b.) These screws must be installed first because once the supercharger is mounted, some of them can not be installed.
- E. Install the supplied 6-rib belt around the 6-rib aluminum pulley on the mounting bracket assembly. Install the supercharger onto the mounting plate with the supplied .53" spacers (see Fig. 6-c) between the supercharger and the mounting plate. Secure with the four  $3/8" \times 1-3/4"$  bolts.
- F. Install the supplied gilmer (toothed) belt around the pulleys on the mounting plate assembly.
- G. Install the three various mounting plate spacers onto their respective screws. (See Fig. 6-b.) A small dab of sealant between the spacer and the mounting plate may help retain them during installation.
- H. Position the supercharger mounting plate assembly in front of the engine and start all of the mounting screws. (See Fig. 6-d.)
- I. Make sure that the coolant hose is routed in front of the supercharger mounting plate.
- J. (Non oil fed applications skip this step) Verify that the oil drain hose is routed as smoothly as possible and connect it to the fitting on the oil pan. Tighten a hose clamp on this connection. Secure the oil drain hose and the A/C line away from the A/C pulley with zip-ties. Trim the drain hose length if necessary.

**NOTE:** Oil in the supercharger is gravity drained to the oil pan. Trim the supplied oil drain hose as necessary so that it is continuously sloping down towards the oil pan. Avoid dips, kinks, etc.

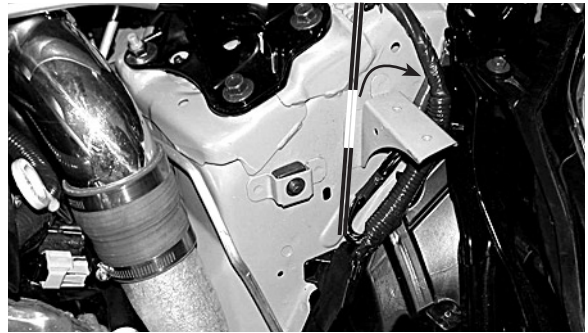

Fig. 6-a

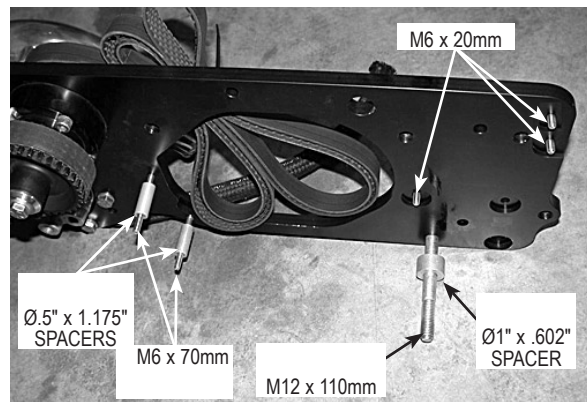

Fig. 6-b

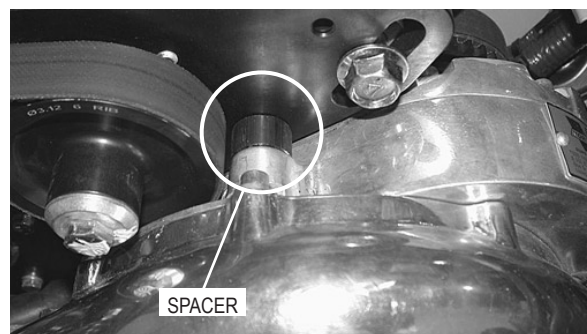

Fig. 6-c

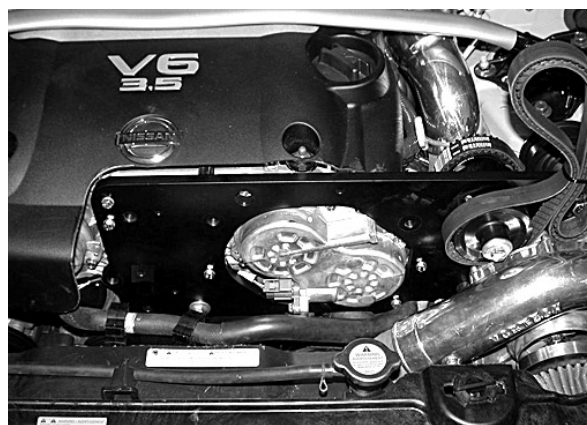

Fig. 6-d

## 6. SUPERCHARGER MOUNTING PLATE INSTALLATION (2005 and Later "Rev-Up" Engines), cont'd.

- K. Route the oil feed hose outside the driver's side frame rail and then to the fitting installed near the oil filter and tighten. Use the supplied zip-ties to secure.
- L. Tighten all of the mounting plate screws.
- M. Install the air filter onto the supercharger inlet and tighten the clamp.
- N. Install the idlers in the positions shown. (See Figs. 6-e, 6-f.)
- O. Using the 12mm screw set aside in *Step 1*, install the aluminum idler with the bearing retaining snap ring pointed towards the rear of the vehicle. The screw should pass through: the idler, a pilot spacer, the 1.1" spacer and the supercharger mounting plate. Install the supplied nut and washer on the end of the screw and tighten the idler so that the gilmer belt is snug. (See Fig. 5-c.)
- P. Install the supplied accessory drive belt as shown in Fig. 6-e. Tighten the belt tensioner until the belt is tight. Tighten the center nut on the belt tensioner idler.
- Q. Use the supplied sheet-metal screw to secure the coolant hose support bracket removed in Section 1. (See Fig. 6-g.)
- R. (Non oil fed applications only) Secure the remote drain hose away from the belt and other hoses using tie-wraps.

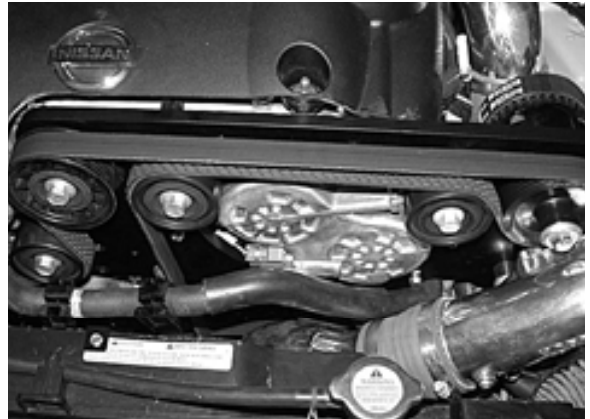

Fig. 6-f

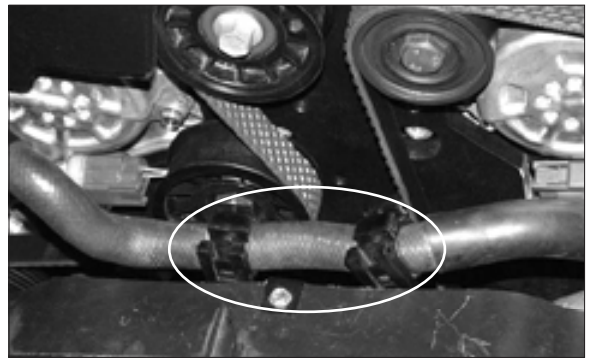

Fig. 6-g

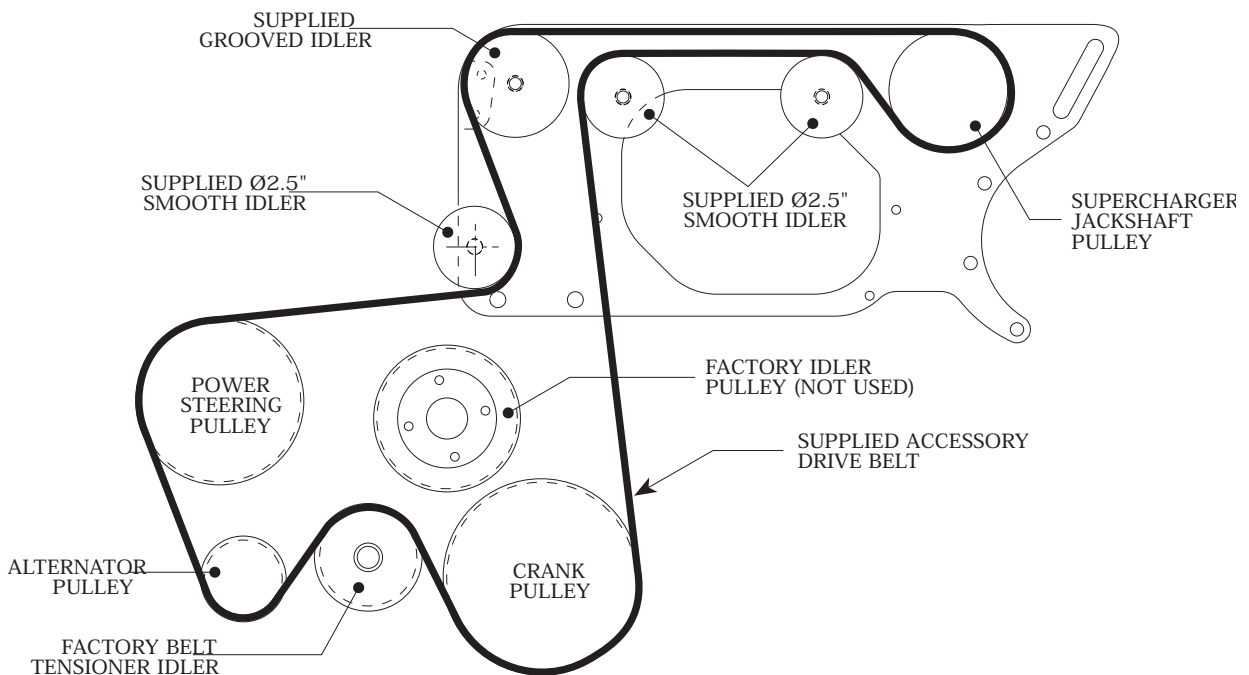

Fig. 6-e / Accessory Drive Belt Routing (300hp Engines)

## 7.1 FUEL MANAGEMENT UNIT (FMU) RECALIBRATION (2005 G35 Only)

**NOTE:** This step applies to Model Year 2005 Infiniti G35 vehicles only! For all others, skip the following and proceed with Section 7.2.

- A. Remove the six allen-head screws on top of the fuel management unit (FMU).
- B. Remove the diaphragm and 7:1 disk and ring from inside of the FMU.

**WARNING:** Do not remove the four screws holding the valve body. Once taken apart, the valve would have to be replaced.

- C. Install the replacement 6:1 ring (with the notched part facing FMU body) around the four screws inside the FMU. (The 6:1 components are smaller diameter than the 7:1).
- D. Place the 6:1 disk inside the ring next to the piston.
- E. Install the new diaphragm and carefully line up the holes to the body.
- F. Place the spring retainer in the center of the diaphragm with the spring between it and the cover. (See Fig. 7.1-a.)
- G. Reinstall the FMU cover with the six allen-head screws. Do not over-tighten the screws. The correct torque is 24 in/lb (2ft/lb).

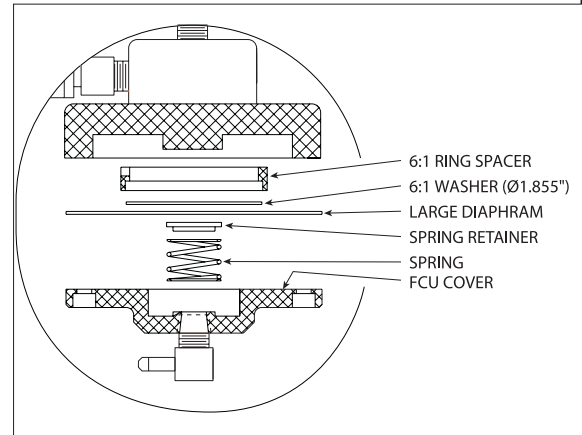

Fig. 7.1-a

## 7.2 FUEL MANAGEMENT UNIT (FMU) AND FUEL PUMP INSTALLATION

- A. Install the FMU in the location shown in Fig. 7.2-a using the supplied sheet metal screws (drill a pilot hole at each location before installing the screw.)

**NOTE:** Ensure that the fuel lines are not kinked and have smooth bends, no chafing etc.

- B. Disconnect the fuel line fitting on the passenger's side frame rail near the engine.
- C. Connect the FMU hoses to the respective fittings on the fuel lines. (See Fig. 7.2-c.)
- D. Install the fuel pump on the driver's side of the front cross member as shown. (See Fig. 7.2-b.) Run a ground wire from the negative terminal on the fuel pump to one of the mounting screws.



Fig. 7.2-a



## 7.2 FUEL MANAGEMENT UNIT (FMU) AND FUEL PUMP INSTALLATION, cont'd

**NOTE:** The positive (+) fuel pump wire will be connected in Section 10.

- E. Cut the FMU line that goes to the vehicle's FUEL TANK and install a 5/16" TEE fitting with clamps. Connect the TEE to the INLET of the supplied fuel pump. (See Fig. 7.2-c.)
- F. Cut the FMU line that goes to the vehicle's ENGINE and install a 5/16" TEE fitting with clamps. Connect the TEE to the OUTLET of the supplied fuel pump.
- G. Remove the vacuum cap from the small bump tube on the front passenger's side on the intake manifold. Use the supplied vacuum hose to connect the pump tube to the fitting on the FMU cover. (See Fig. 7.2-d.)
- H. Install a short length of vacuum hose onto the protruding roll-pin that is installed into the FMU body. Use a small amount of sealant and route and secure the hose so that the open end is pointed towards the ground to minimize water entrance. (See Fig. 7.2-c.)



Fig. 7.2-b



Fig. 7.2-d

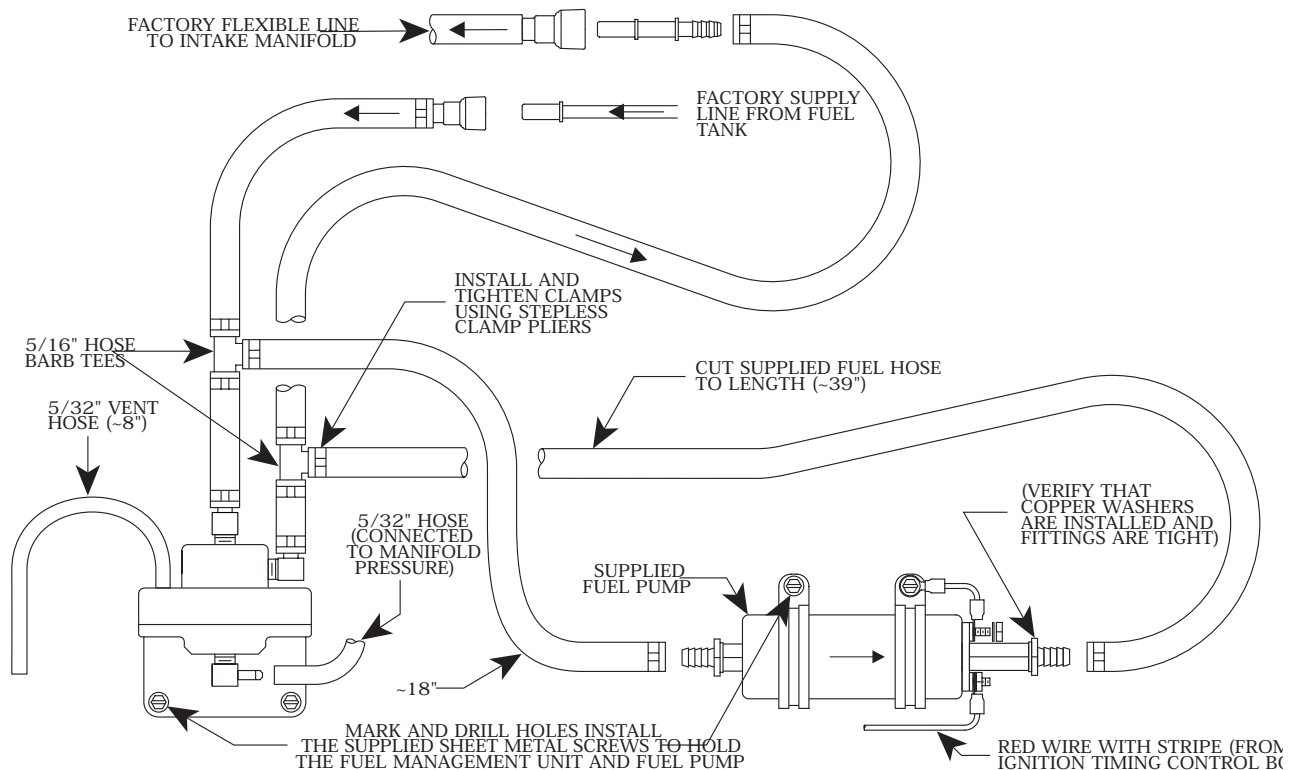

Fig. 7.2-c

## 8. CHARGE COOLER INSTALLATION

- A. Remove the wire loom hold-downs from the front of the radiator core support. Remove the brackets securing the power steering cooler lines to the core support.
- **G35 Vehicles, All:** Remove the foam inner bumpers on the driver and passenger sides of the Charge Air Cooler mounting location. Locate and remove the power steering hard line brackets. Cut the threaded section off of the bracket just removed. Install the threaded piece behind the core support and clamp the hard lines to the front of the core support as shown in *Fig. 8-a*.
  - **G35 Vehicles, Automatic Only:** Remove the two rubber lines from the transmission cooler. Remove the two rubber transmission cooler lines from the junction on the passenger's side frame rail. Remove the hard lines with the rubber lines still attached from the vehicle. Once the transmission cooler has been repositioned, connect the cooler to the junction using the rubber line provided. Secure with factory clamps.
- B. Using the supplied adhesive backed foam to insulate the power steering cooler from the radiator, position it as shown in *Fig. 8-b*. Install the snap connectors on the free end. Cut off any excess that would interfere with radiator fan operation.
- C. Rotate any clamps that are pointing toward the front of the vehicle so that they will not contact the charge air cooler. Use the supplied zip-ties to secure the wire loom to the air temp sensor and the power steering hose.
- D. Temporarily attach the two supplied matching metal brackets to the bottom of the radiator core support using two of the factory splash pan screws. (See *Fig. 8-c*.)
- E. Attach the remaining metal bracket to the charge cooler using the supplied 1/4" x 3/4" hardware. (See *Fig. 8-d*.)
- F. Install the cooler in front of the radiator and rotate the metal brackets to support it as shown.
- G. Mark the plastic panels on either side of the cooler for passage of the Ø2-1/2" cooler tubes. Remove the cooler and drill a horizontal 2.5" hole (*minimum*) through each of the plastic panels. (*If the vehicle has foam blocks that interfere with the discharge ducts, remove the foam from the vehicle.*)
- H. Reinstall the cooler. Connect the upper cooler bracket to two of the factory screws that secure the front bumper. Align cooler for best fit and tighten the four screws that attach the bracket.

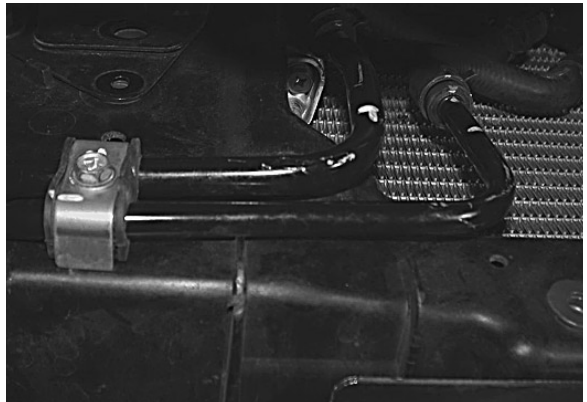

Fig. 8-a

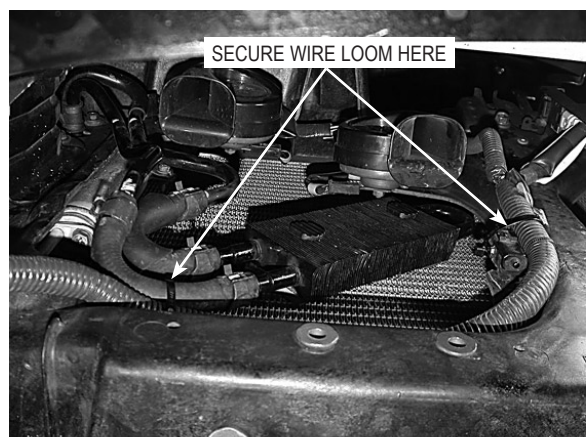

Fig. 8-b



Fig. 8-c



Fig. 8-d

## 8. CHARGE COOLER INSTALLATION, cont'd.

**NOTE:** The G35 may have only one factory screw and a push-pin. Reinstall the one factory screw. In the second hole, use the supplied 1/2-20 x 1" screw, washer and nylock nut.

- I. Install the ducts on both sides of the cooler. Connect the driver's side duct to the previously installed duct that is connected to the MAF. Trim or remove the small plastic panels that interfere with the ducting. (See Fig. 8-e.)
- J. Install the supercharger discharge duct from above the vehicle. Use a 2.75" to 2.5" reducer sleeve to connect it to the supercharger and the remaining sleeve to connect it to the previously installed charge cooler duct. On vehicles equipped with automatic transmissions, it is normal for the discharge duct to deform the transmission cooler line as shown. (See Fig. 8-f.)
- K. Position all ducting for best fit and tighten clamps on each connection.
- L. Remove the two brackets that were used to hold the core up during installation.

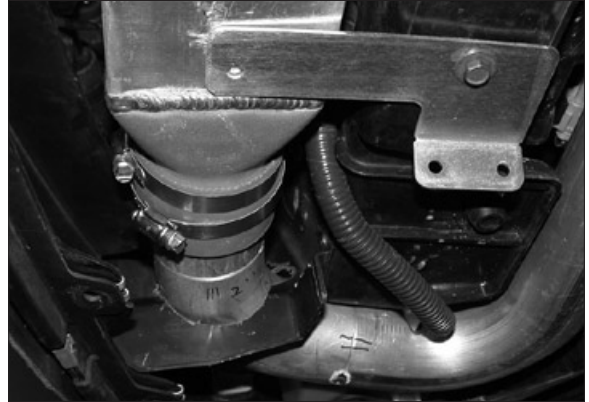

Fig. 8-e

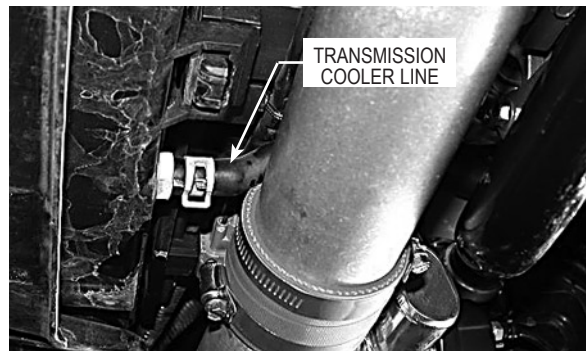

Fig. 8-f

## 9. SUPERCHARGER BYPASS VALVE INSTALLATION

- A. Using the supplied gasket and 1/4" hardware, install the bypass valve onto the flange on the passenger's side under the vehicle. (See Fig. 9-a.)
- B. Connect 5/32" vacuum line from the bypass valve to a TEE fitting installed in the FMU manifold vacuum reference hose.

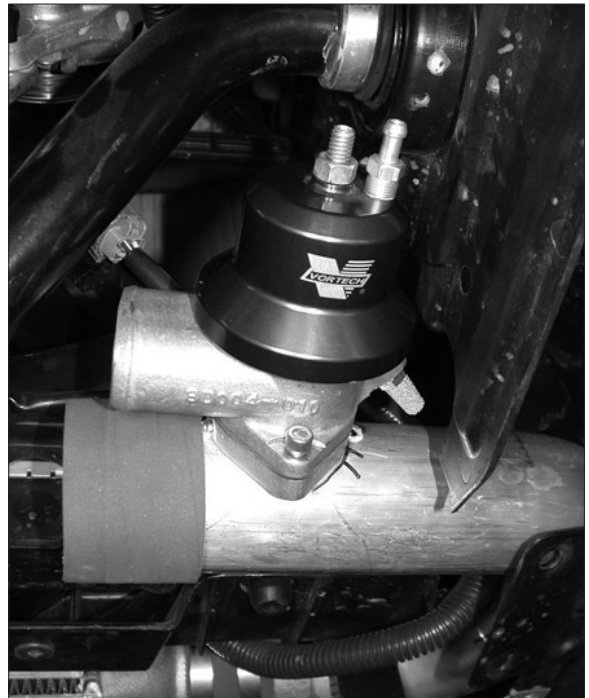

Fig. 9-a



## 10. 2003-2005 STANDARD ENGINE TIMING CONTROLLER INSTALLATION (For 2005 "Rev-Up" and 2006 Vehicles Skip to Section 11)

- A. Remove the inspection cover over the battery. Remove the plastic clips securing the larger cover over the battery and remove it as well.
- B. Using the supplied adhesive backed Velcro, position the ignition timing control computer next to the battery as shown. (See Fig. 10-a.)
- C. Run the wires through the firewall grommet next to the main ECU wiring harness.
- D. The ECU is located behind the passenger's side kick panel. Remove the door scuff panel and the kick panel.
- E. Remove the ECU harness connector by pulling on the lever. Remove the plastic cover from the connector so that the wires can be traced to their respective terminals. (See Fig. 10-b.)

**NOTE:** Always verify each pin location. Wire color is provided as a reference only. If there is a discrepancy between wire color and pin location, disregard wire color and use the numbered pin location.

- F. See Fig. 10-c for the ECU harness connector terminal layout as viewed from the side of the connector where the wires are inserted.
- G. Connect the thin 20Ga **RED** wire to battery positive switched by the ignition (*ECU harness connector terminal 109*). Use the supplied T-Tap and spade connector.
- H. Connect the **BLACK** wire to the ECU ground (*Terminal 115*). Use the supplied T-Tap and spade connector.
- I. Locate and cut the MAF sensor signal wire (*Terminal 51*).

**NOTE:** Soldered wire connections are more sound than crimp-on connectors because they can be inspected. It is up to the installer to guarantee good connections. If there is any doubt, or the vehicle performs erratically, solder and insulate each connection.

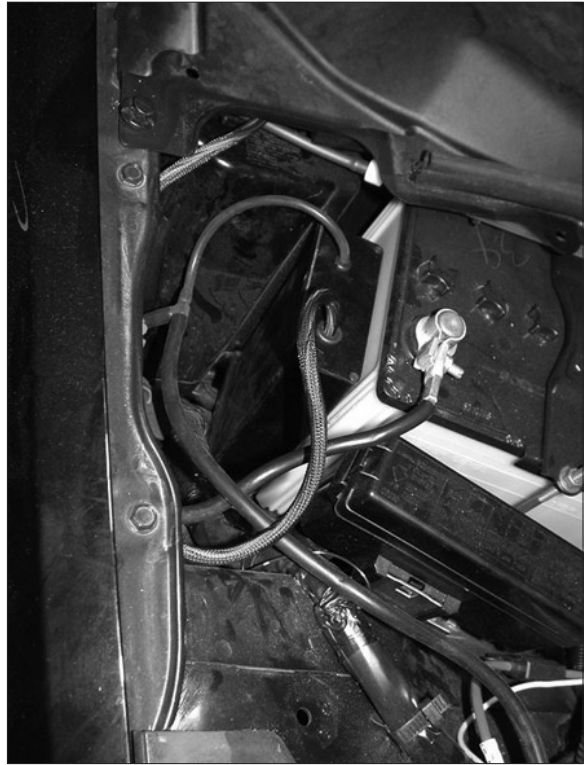

Fig. 10-a

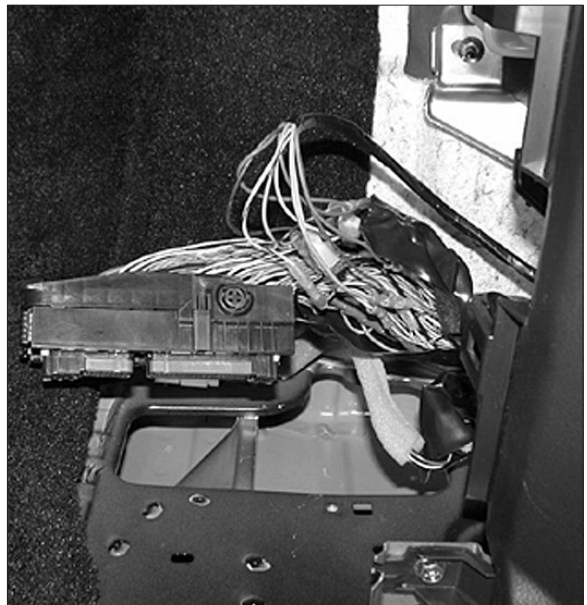

Fig. 10-b



## 10. TIMING CONTROLLER INSTALLATION, cont'd

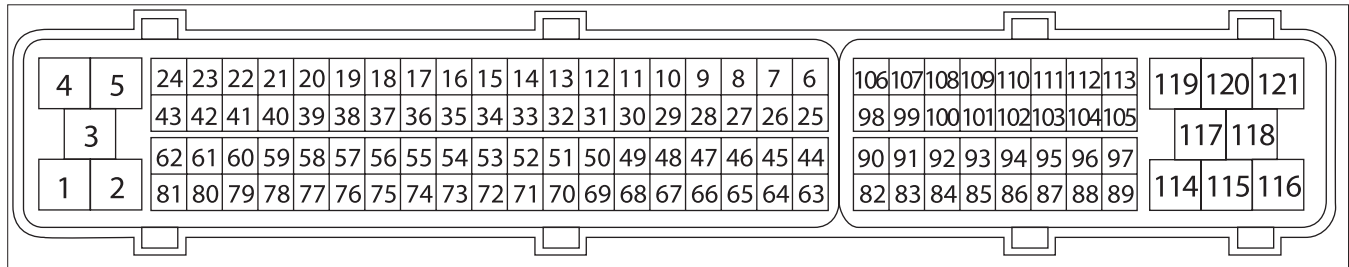

Fig. 10-c / As viewed from the back of the connector (Where the wires are inserted)

- J. Connect the **GREEN** wire to the wire leading to the MAF sensor. (*Terminal 51*).
- K. Connect the **VIOLET** wire to the wire leading to the ECU MAF sensor input.
- L. Locate the crank sensor signal wire and cut it (*Terminal 13*).
- M. Connect the **BLUE** wire to the wire leading to the crank sensor.
- N. Connect the **BLUE/WHITE** wire to the wire leading to the ECU crank sensor input.
- O. Locate and cut the **CAM 1** sensor signal wire and cut it. (*Terminal 33*).
- P. Connect the **YELLOW** wire to the wire leading to the cam sensor.
- Q. Connect the **YELLOW/BLACK** wire to the wire leading to the ECU cam sensor input.
- R. Locate and cut the **CAM 2** sensor signal wire and cut it (*Terminal 14*).
- S. Connect the **TAN** wire to the wire leading to the cam sensor.
- T. Connect the **TAN/BLACK** wire to the leading to the ECU cam sensor input.
- U. Connect the large 12-gauge **RED** wire to the battery (+) positive terminal, using the supplied ring terminal connector.
- V. Reinstall the ECU plug and interior panels.
- W. The **STRIPED RED** wire needs to be connected to the Positive terminal of the previously installed fuel pump. Use the supplied plastic wire loom to enclose the wire. Route it down the passenger's side of the engine and secure it away from heat and sharp edges.
- X. The vacuum hose on the timing controller should be connected to intake manifold vacuum using the supplied TEE and hose.
- Y. Reinstall the battery covers.

**Skip to Section 12**

# 10. TIMING CONTROLLER INSTALLATION, cont'd

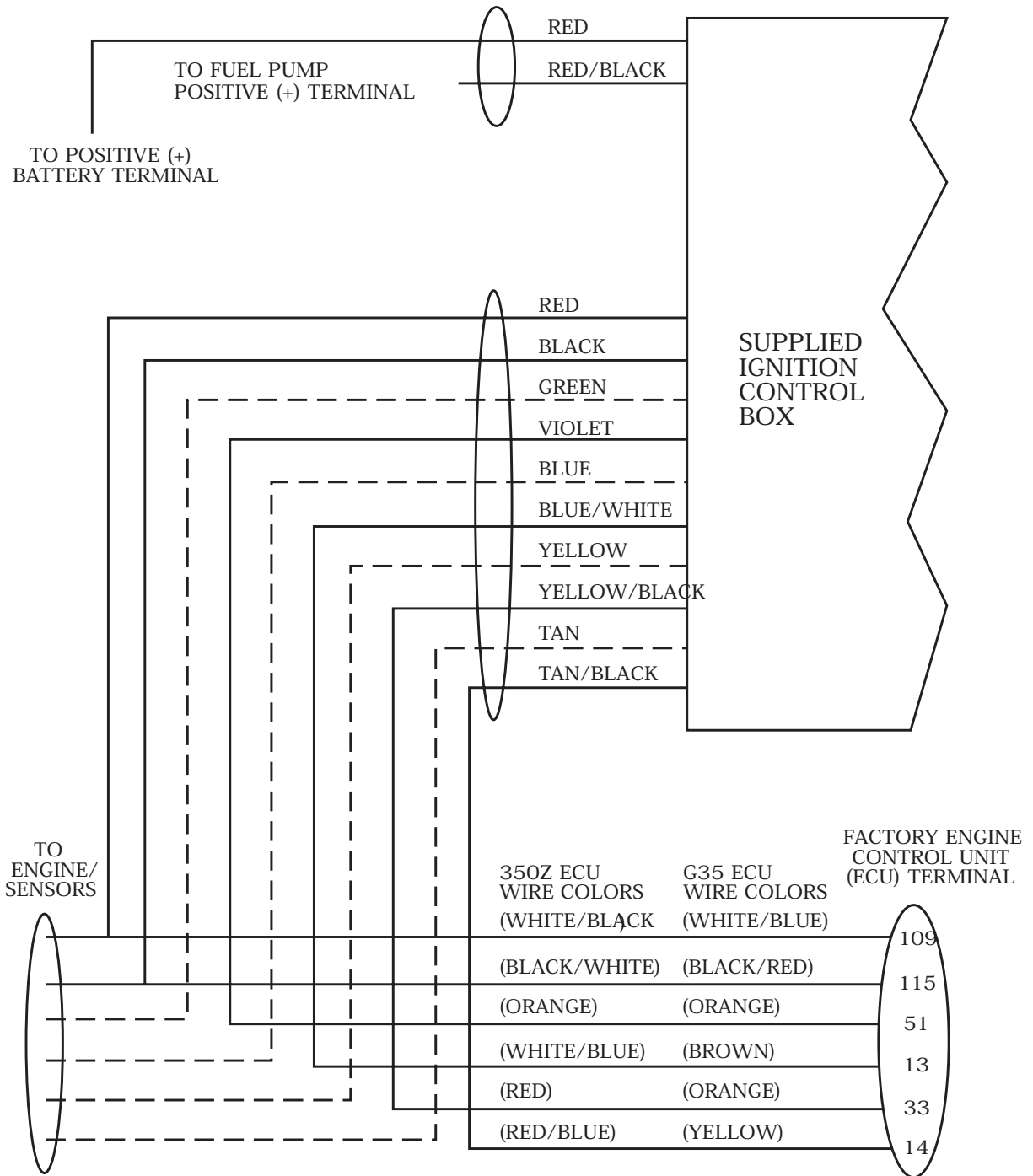

Fig. 10-d / Wiring Diagram

**11. 2005 “REV-UP” AND 2006 VEHICLE TIMING CONTROLLER INSTALLATION** (For 2003-2005 Standard Engine Vehicles, Skip This Section and Proceed with Section 12)

- A. Install the supplied “piggyback ECU” per the instructions supplied with the unit.

**NOTE:** There is no “accessory cable functionality” used with the supercharger kit and it should be removed from the ECU if equipped.



Fig. 11-a

- B. Install the supplied fuel pump relay in the passenger’s side/rear of the engine compartment as shown. (See Fig. 11-a.)
- C. Run the white-with-red-stripe wire and the brown wire from the “piggyback ECU” connector to the relay.
- D. Attach the white-with-red-stripe wire to terminal #85 on the relay using the supplied slide connector. (See Fig. 11-b.)

- E. Attach the brown wire and the supplied black wire to terminal #30 on the relay.

- F. Attach one end of the supplied fuse holder pigtail and the supplied red (*fuel pump power*) wire to terminal #86 using a female slide connector.

- G. Attach one end of the supplied black (*fuel pump ground*) wire to terminal #87.

- H. Attach the open end of the fuse holder to the positive battery terminal using the supplied ring terminal connector.

- I. Attach the fuel pump power wires to their respective terminals using the supplied ring terminal connectors.

- J. Install the fuel pump fuse in the fuse holder and install the supplied plastic wire loom over the wires.

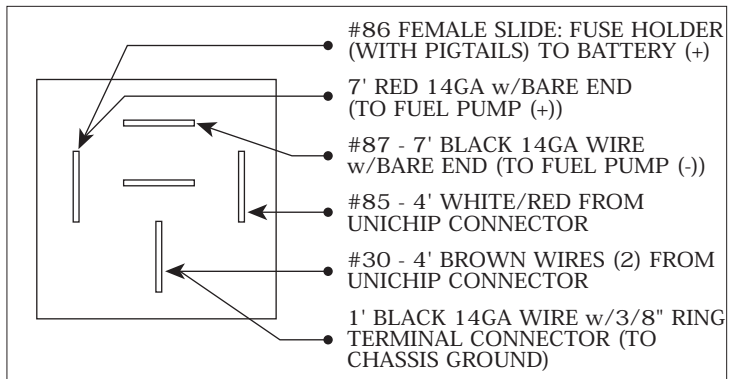

Fig. 11-b

## 12. FINAL ASSEMBLY AND CHECK

- A. If your vehicle has gone over 20,000 miles since its last spark plug change, it is a good idea to change the spark plugs now, before test-driving.
- B. Make sure that oil drain to oil pan fitting is tight and that the engine is filled with factory specified oil. Check the oil drain hose to make sure it is not touching the A/C pulley.
- C. Make sure that the vehicle is filled with 91 octane or higher fuel before commencing a test drive.
- D. Check all fittings, nuts, bolts and clamps for tightness.

**WARNING:** Do not attempt to operate the vehicle until ALL components are installed and ALL operations are completed including final check. Failure to do so may cause PREMATURE FAILURE OF MAJOR COMPONENTS.

- E. In order to check the accessory belt tension, turn on as many electrical loads as possible (*headlights, A/C, etc*) This will place maximum load on the alternator at startup. If belt squeal is heard, tighten the belt tensioner until it is eliminated. This most often occurs immediately after starting the vehicle because the alternator is drawing maximum load.
- F. At this point, it is OK to start the vehicle. Verify that the gilmer belt is running smoothly. If wear is detected on the side of the belt, it is probably too tight. If it is vibrating excessively, tighten until there is minimal movement. Mildly rev the engine to check for belt squeal.
- G. Turn off the vehicle and recheck all fluid levels and verify that no hoses, wires, etc. are near exhaust headers or moving parts and that there is no fluid leakage.
- H. Test drive the vehicle by gradually working up to full throttle and paying close attention to any abnormal sounds or engine detonation.
- I. If belt squeal is heard, tighten the accessory belt tensioner until it is eliminated.
- J. Re-install the splash pan and the plastic engine cover. The engine cover will need to be trimmed to clear the accessory drive belt (see *Fig. 12-a*). Re-install the strut tower brace (if previously removed).
- K. Read the STREET SUPERCHARGER SYSTEM OWNER'S MANUAL and return the WARRANTY REGISTRATION FORM within (30) days of purchasing your supercharger system to qualify for the 3-year limited warranty.

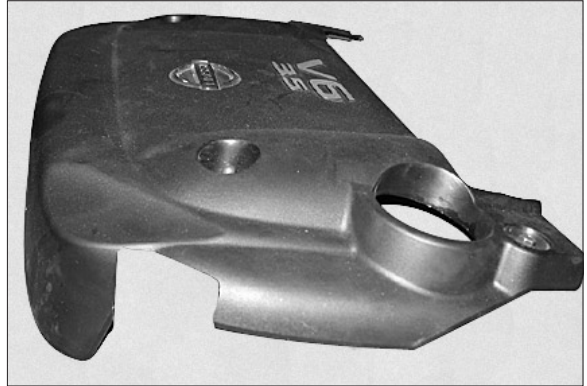

Fig. 12-a



Fig. 12-b (350Z)



Fig. 12-c (G35)

**WARNING:** Never operate your engine at full throttle when the engine is cold. Always allow plenty of time for the oil to reach full operating temperature before running above 2,500 RPM. Full supercharger operating temperature is generally achieved only after the engine water temperature has been at the normal indicated operating range for several minutes.

## 12.1. FINAL CHECK, CONT'D

### For internally lubricated V3 units only

This supercharger has been factory pre-filled with special Vortech synthetic lubricant. Oil does not need to be added to a brand new unit; however a fluid level check should be performed.

Prior to operating the supercharger on the vehicle and after installation onto the vehicle:

Remove the factory installed flat-head brass shipping plug (not the dipstick) from the top of the supercharger case. Replace the sealed shipping plug with the supplied "vented" plug. Do not operate the supercharger without it. Check the supercharger fluid level.

#### **Fluid level checking procedure:**

1. Ensure that the .06" copper sealing washer is located on the dipstick base.
2. Thread the clean dipstick into the unit until it seats.
3. Once the dipstick has seated, remove the dipstick from the unit. Fluid should register in the crosshatched area on the dipstick.
4. **DO NOT OVERFILL!!!** Drain excess fluid from the unit if it is above the maximum level on the dipstick.

Check the fluid level using the dipstick at least every 2,500 miles.

Initial supercharger fluid change must be performed at 2,500 miles. The supercharger fluid must be changed at least every 7,500 miles.

Drain the fluid, refill the unit with 4 oz. of Vortech V3 lubricating fluid and then confirm proper oil level using the dipstick. **DO NOT OVERFILL!!!**

**WARNING:** Use of any other fluid other than the special Vortech lubricant will void the warranty and may cause component failure.



**ENGINEERING, LLC**

1650 PACIFIC AVENUE • CHANNEL ISLANDS, CA 93033-9901 • (805) 247-0226  
FAX (805) 247-0669 • [www.vortechsuperchargers.com](http://www.vortechsuperchargers.com) • M-F 8:00 AM - 4:30 PM PST