

By Evakool

Instruction Manual

Danfoss



Nexberg Pty Ltd T/a Evakool
16 Enterprise St CALOUNDRA
QLD 4551

Tel : 07 5492 7777

Fax : 07 5492 7733



NOTE:

Your fridge is preregistered with the following user account for the APP.

User: 12345678900

Password: 123456

Please read these instructions and the Safety section carefully before using your refrigerator.

- | | |
|-------------------------------|-----------|
| 1. Safety Instructions | Page 2 |
| 2. Notes on using the product | Page 2 |
| 3. Operation | Page 2-4 |
| 4. WiFi Operation | Page 4-12 |
| 5. Cleaning and Maintenance | Page 13 |
| 6. Troubleshooting | Page 14 |
| 7. Error Codes | Page 15 |
| 8. Warranty Statement | Page 16 |



Instruction Manual

Features:

- Reliable cooling system – Danfoss compressor
- Efficient electronic technology, low energy consumption
- Multi-voltage system (DC 12-24 Volt) and (AC 100-120/220-240 Volt)
- Digital Battery Protection, protect your vehicle battery effectively

1. Safety Instructions

- Warning: Do not touch exposed cables.
- Warning: Do not use fridge if you suspect any connections could be wet.
- When using the fridge in the vehicle or boat, please make sure the circuit being used is fused.
- Any installation of DC power systems should be handled by a qualified professional.
- Make sure the source voltage is correct. The technical data label has the voltage data.
- Do not place any electrical devices inside the refrigerator as moisture could harm these devices.

2. Notes on using the product

- ❖ Your refrigerator requires good ventilation, especially around the vents of the refrigerator; allow a gap of at least 200mm around the vents.
- ❖ Humidity inside the appliance can form frost and impair cooling. Do not allow frost to build up. Never clean the appliance using a hose and never submerge the unit in any liquid.
- ❖ Avoid placing your refrigerator near a heat source. This helps the refrigerator to work more efficiently and keep the contents cool.
- ❖ Place the refrigerator on a flat surface and away from any edges. When using the fridge in a vehicle, please use a fastening device to secure it.

3. Operation

- ❖ **Power:** The electronic control module controls the compressor motor and has the function of a three stage battery protection. When the input voltage drops below the minimum, the compressor will cut out; when the voltage comes back up to the cut-in value, the compressor will restart automatically.
- ❖ **Battery Protection:** The Danfoss compressor requires approximately 11.0 Volts (12 Volt System) or 23.0 Volts (24V System) to operate. If the voltage drops below this the fridge will stop running.

❖ Cable Specification

The DC cables must have a suitable cross-section for their length, according to this table:

***Note:** The length is from the battery to the refrigerator.

Cable Area		12V Max Cable Length*		24V Max Cable Length*	
[mm ²]	AWG	[m]	[ft.]	[m]	[ft.]
2.5	13	2.5	8	5	16
4	11	4	13	8	26
6	9	6	20	12	39
10	7	10	33	20	66

Instruction Manual

SINGLE ZONE

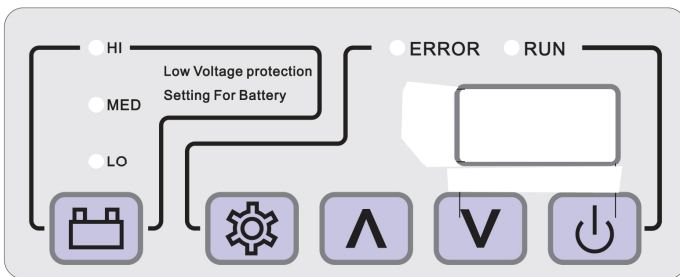

DUAL ZONE

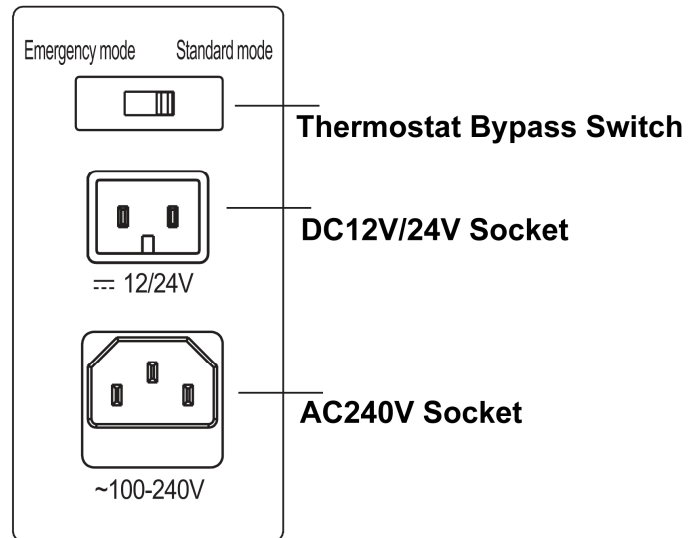
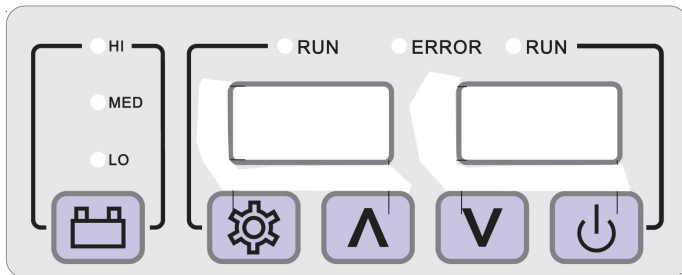

Using the Fridge

- **NOTE: IF THE UNIT IS IN STAND-BY MODE ONLY AN ORANGE RUN LED WILL BE ILLUMINATED. TO TURN ON YOUR UNIT PLEASE HOLD THE ON/OFF SWITCH DOWN UNTIL THE RUN LED CHANGES TO GREEN AND THE TEMPERATURE READ-OUT DISPLAY IS ILLUMINATED.**
- Temperature setting range: $-18^{\circ}\text{C} \sim 10^{\circ}\text{C}$, $0^{\circ}\text{F} \sim 50^{\circ}\text{F}$
- Plug in the DC or AC power cable. Use the ON/OFF switch to run the fridge. The LED display on the control panel will light up and the interior temperature will be displayed.
- Press SET and then press the Δ UP and ∇ DOWN buttons to adjust the temperature. Press the button Δ to increase while the button ∇ to decrease the temperature. To lock in the target temperature press set twice or leave for 5 seconds. The display board will display the current temperature inside the unit after the target temperature is set. After approximately 5 minutes the displayed temperature will start to decrease.
- If the power supply is cut off, the refrigerator will switch off automatically and then automatically switch on again when the unit receives power.
- To change the fridge between $^{\circ}\text{C}$ and $^{\circ}\text{F}$. Press SET twice and then Δ UP or ∇ DOWN to change the setting.
- To change the battery voltage setting press the BATTERY button for three seconds and then use the BATTERY button to change between the settings. Leave the unit for 5 seconds to set this setting. The three voltage settings are approximately as follows :- (We advise to keep the setting on LOW)
 - LO – 11.0 Volts
 - MED – 12.0 Volts
 - HI – 12.5 Volts



By Evakool

Instruction Manual

- LED explanation.
 - Orange RUN LED – Temperature zone not cooling
 - Green RUN LED – Temperature zone cooling
 - Orange RUN LED and Temperature Read-out blank – Unit in Stand-by Mode.
- If dual zone unit; display panel will contain 2 Temperature Read-out's. Press the Set button once to set left bin temperature, twice to set right bin and thrice to set temperature mode.

4. WiFi OPERATION

The fridge has been designed with the latest technology. You are able to easily download the EVAKOOL APP from the Google Play store or the Apple iTunes Store.

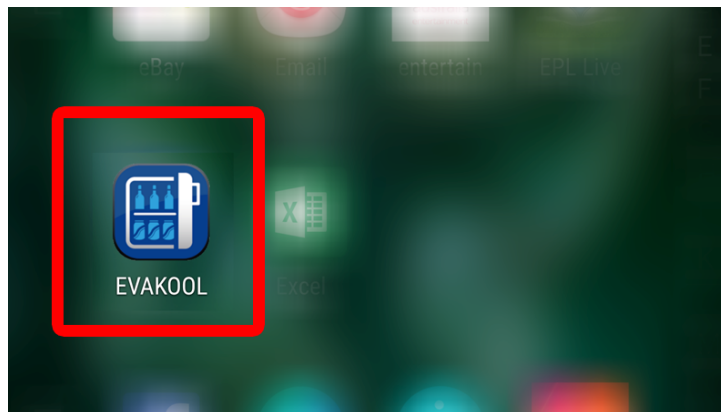

Once the APP is installed please follow these easy instructions to be able to control and monitor your fridge.

SCREENSHOT SHOWING WIRELESS NETWORK CREATED BY THE FRIDGE





By Evakool

Instruction Manual

To use your Smartphone with your fridge you must first be on the same Wireless Network as the fridge. The fridge creates its own wireless network which you must connect to in the settings of your phone.

Please take note of the **Fridge ID** number as it will be required for the APP. To connect to the wireless network you will need a **pass code** which is “55555555” (8x 5’s). If you have any issues connecting to the WiFi network please review the troubleshooting area at the end of this section.

Once you have connected to the Wireless network and it states that you are connected you can now proceed to pair your fridge with the APP.

PLEASE NOTE: You will not be able to use the internet while connected to the fridge.

To pair the fridge with the APP, follow these steps:-

- a) Open APP
- b) If the fridge is not automatically added then you will need to click the ADD button at the bottom of the screen.

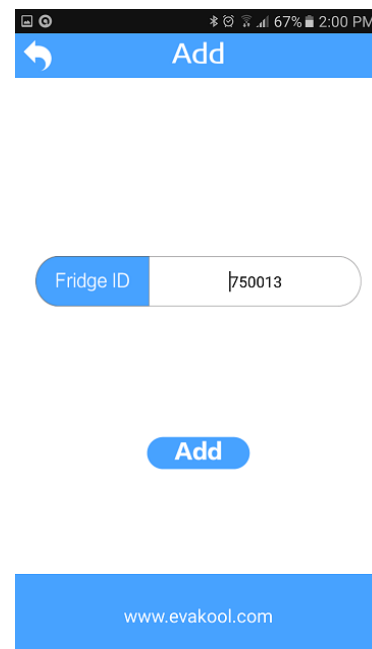

This will allow you to add your fridge and pair it with you phone/APP. The Fridge ID is the last six numbers of the WiFi Network name so in this example the fridge ID is “750013”.



Instruction Manual

c) You will then need to register a new login.

The image shows two screenshots of the evaKOOOL mobile app. The left screenshot is the 'Login' screen, and the right screenshot is the 'Register' screen. The 'Register' screen has the following fields:

- USER ID
- Type
- Password (with a note: "please input 6-bit password")
- Confirm Password
- E-mail
- Fridge ID (with a note: "45002E")

There are also 'Login' and 'Forget Password' buttons on the left, and a 'Register' button at the bottom right of the form. The website address 'www.evakool.com' is displayed at the bottom of both screens.

To register please fill out the fields:-

USER ID – An 11 digit number i.e. 12345678900

Type – You need to select “Average User” the upgrade registration will be provided by Evakool. This can be obtained once your warranty is registered online by emailing sales@evakool.com and requesting the upgrade code.

Password – Please choose a 6 digit number. i.e. 123456

Confirm Password – Re-Confirm the Password

Email – Enter your email address,

Fridge ID should be already filled in.

Then click Register.

NOTE:

Your fridge is preregistered with the following user account for the APP.

User: 12345678900

Password: 123456



By Evakool

Instruction Manual

- d) You will then need to login using your registered details.
- a) USER ID : xxxxxxxxxxxx (As per your registration)
 - b) PASS : xxxxxx (As per your registration)

8:32 AM 88%
Login Register
evaKOOOL
Fridge ID 750013
USER ID 12345678900
Password
Login Forget Password
www.evakool.com

NOTE – If you would like to upgrade the APP to be able to change the temperature and view the graph of voltage and temperature please follow the next steps.

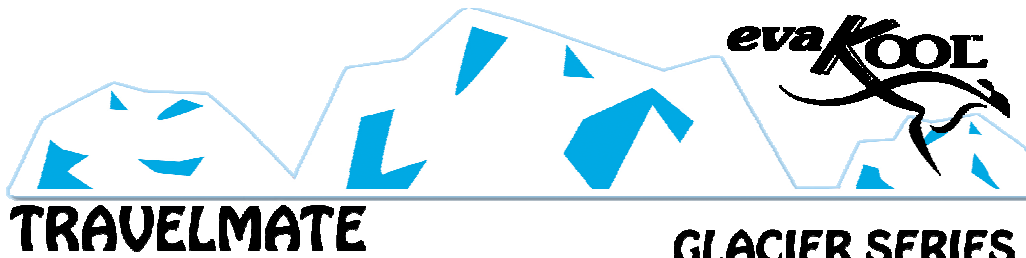

Instruction Manual

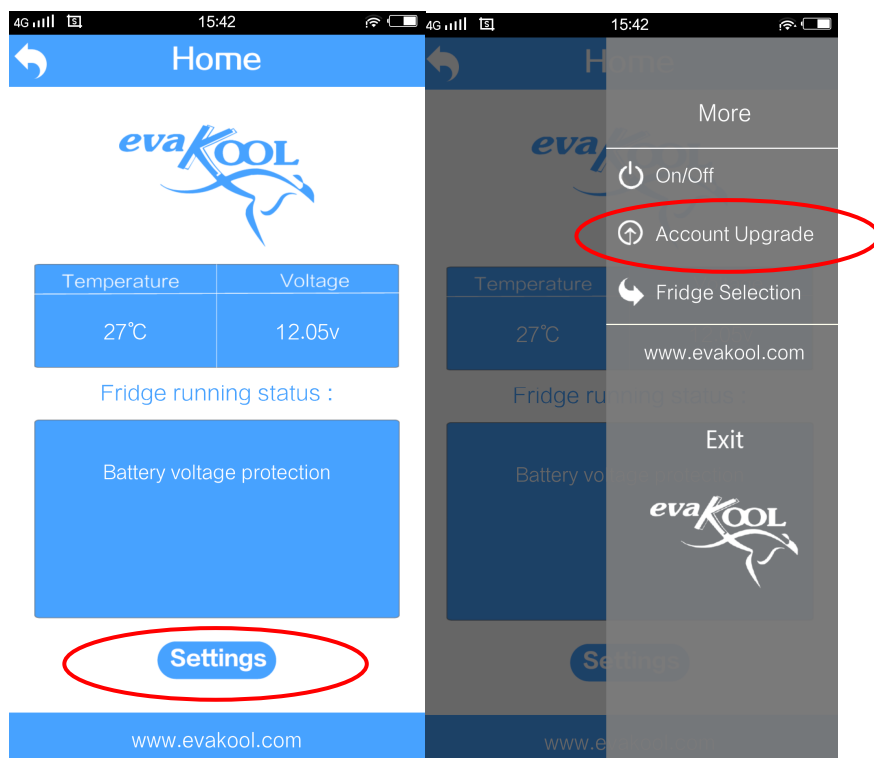

Click Settings and then click Account Upgrade.
Then Enter in your USER ID and the registration code provided to you by Evakool and then click SAVE.





By Evakool

Instruction Manual

Your Account will now be upgraded.

- e) Once logged in you can view the fridge's current running temperature and the voltage as well as any error messages.

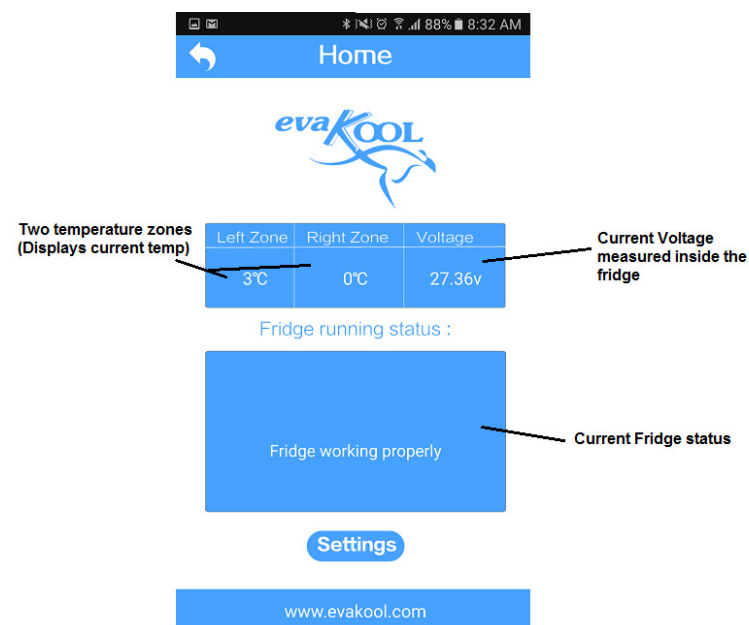

- f) When you click the settings button a menu will extend out from the right hand side where additional changes to the fridge can be made. Click the “**Settings**” Button.

There are various menus in this side menu each of which is detailed below:-

- Settings – **Change the temperature**, °C or °F and also the **low voltage battery cut out**.
- Graph** – The fridge can log the temperature and voltage data. You can use this to make sure your fridge is operating correctly.
- On/Off** – Switch your fridge on or off
- Fridge Selection** – ADD/DELETE current paired fridge

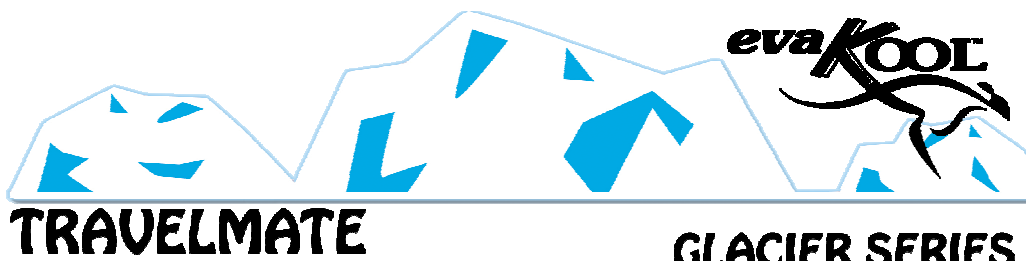

By Evakool

Instruction Manual

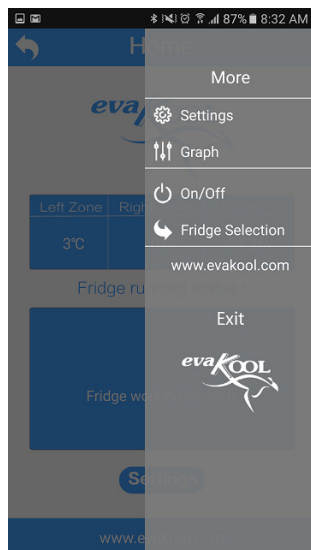

- g) You can change multiple settings on the below page :-
- To change °C to °F simply click the button you want.
 - To change the temperature simply move the bar left or right.. If you are using a single zone fridge then the left zone is the default zone.
 - To change the Low Voltage Protection click the letter corresponding to the setting you require (LOW Recommended)
 - To save any changes click the SAVE button.

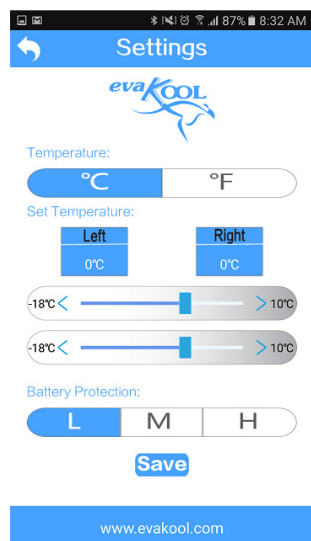



By Evakool

Instruction Manual

GRAPHING

- h) The fridge is able to log data of the temperature and voltage recorded by the fridge. This can be handy when trouble shooting. (E.g. If you have a problem once the fridge has been running for a while you can review this data. Take a screenshot (Refer to Google on how to take a screenshot with your model Smartphone) and then email it to Evakool for review, if necessary.)

The data is viewable after approximately 10 minutes of running. The maximum data recorded is approximately 24 hours, worth.

Note: The temperatures recorded are in the walls so there may be some variation and delay compared to air sensing thermometers.

Note: The voltages recorded are measured inside the fridge at the internal connectors so these will be different to your battery/solar voltage readings.

Take note that you may have to zoom in or out to see the full graph. This can be done using your fingers in a pinching motion.

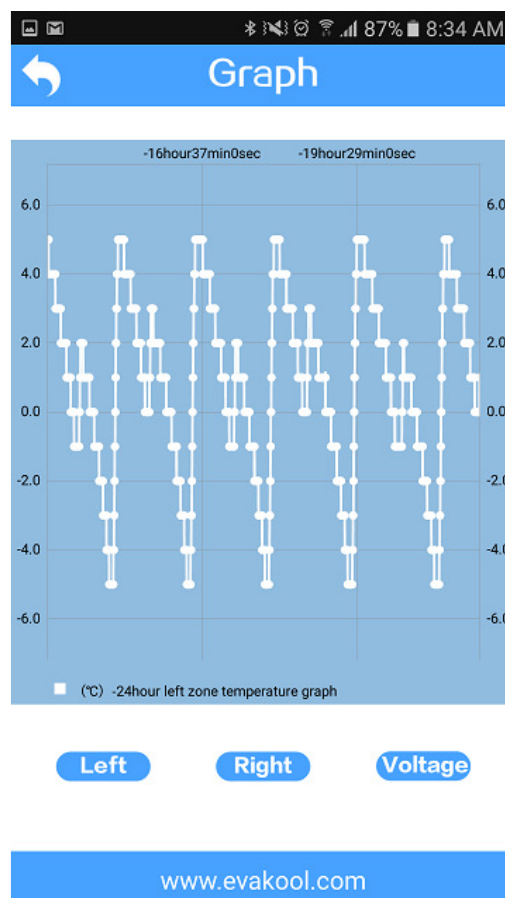



By Evakool

Instruction Manual

i) The fridge can be switched on or off using the following screen.

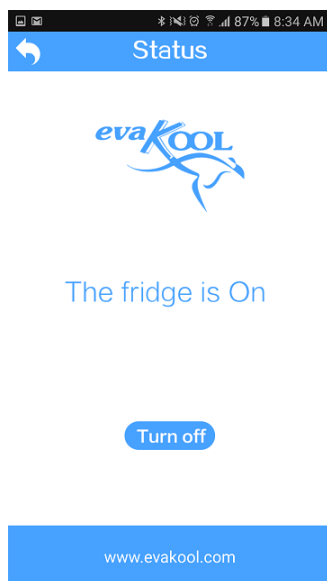

TROUBLESHOOTING THE WiFi APP

I can't see or connect the Wireless network

- Make sure WiFi is turned-on, on your device.
- Make sure you are in range of the fridge (normally around 10-20 meters)
- Make sure you are using the correct pass code “55555555” (8 x 5's) for the WIFI Network.
- Make sure you are not connected to a different Wireless network
- Try turning the fridge and your phone on and off

I can't pair the fridge with the APP

- If you have followed the above steps and can confirm that you have connected to the fridge's wireless network then proceed if not refer to above troubleshooting on connecting phone to fridge's wireless network.
- Make sure the Fridge ID is the same as the Wireless network as on page 5.
- Make sure you are using the correct user ID and Password as per page 7. (Note C)
 - **If the above failed then follow the below steps:-**
- Uninstall the APP. Close all APPs in the background.
- Turn both the fridge and the phone off.
- Turn both the fridge and the phone back on after a couple of minutes.
- Re-install the APP.

If you are still having problems please do not hesitate to contact Evakool.



By Evakool

Instruction Manual

5. Cleaning and maintenance

- Clean the appliance inside and out with a damp cloth every week. If it is dirty, use sodium bicarbonate dissolved in lukewarm water to clean the unit.
- Never use abrasive products, detergents or soap. After washing, rinse with clean water and dry carefully. Do not leave the refrigerator off with food inside or lid closed.
- Never clean the appliance under running water. Do not use abrasive cleaning agents or hard objects during cleaning as these can damage the refrigerator.

6. Troubleshooting

PLEASE NOTE: This fridge is fitted with an automatic 60 second re-start delay. This will be activated if your fridge enters an error mode. This is to protect the fridge if an error has occurred.

- The appliance is not turning on.
 - Check the power supply
 - Check whether the plug and the socket have a good connection.
 - Check whether the fuse requires replacement
 - Check whether the appliance has been turned on
- The food inside is frozen.
 - The setting temperature is too low
- Bad performance in refrigeration
 - The temperature setting is inappropriate
 - The lid is unlocked/or open
 - The lid seal is broken
 - Problems arising from poor ventilation
 - There is no room around the fridge and vents
 - Too much food been placed inside the refrigerator
 - There is too much warm product inside
 - There is a heat source near the unit
- Hear the sound of water from inside the unit
 - This is normal, due to the flow of the refrigerant.
- Unusual noise when refrigerator is working
 - The refrigerator is not placed on a level surface
 - Some part has come loose inside the refrigeration compartment (see a service agent)



By Evakool

Instruction Manual

7. Error Codes

The error codes are depicted by a number of flashes by the error light in a sequence every four seconds.

<u>Code</u>	<u>Reason / Solution</u>
1 Flash	Low Voltage <ul style="list-style-type: none"> - Please check the source voltage to ensure it is above the cut out. Try lowering the voltage cut out setting to LOW. - The vehicle cabling may be inadequate/unsuitable, please refer to cable specifications table for correct cable thickness (Page 2) - Try on a different power source
2 Flashes	Fan issue <ul style="list-style-type: none"> - Fan is drawing too many Amps (Over 1 Amp) – Contact Evakool
3 Flashes	Compressor Start Issues <ul style="list-style-type: none"> - Unplug for 10 Minutes - Try on a different power source. - Possible Electronic Box or compressor fault – contact Evakool
4 Flashes	The compressor speed is too low <ul style="list-style-type: none"> - Unplug for 10 Minutes - Reduce product load inside unit - Move unit to a lower ambient temperature - Clean vents / ensure clear air flow over compressor
5 Flashes	Ambient Temperature too high <ul style="list-style-type: none"> - Clean vents / ensure clear air flow - Fan Fault – Contact Evakool



By Evakool

Instruction Manual

EVAKOOL TRAVELMATE FRIDGE FREEZER RANGE

Warranty Statement TERMS & CONDITIONS

Nexberg Pty. Ltd. trading as EvaKool undertakes to the original purchaser that this product is sold free of defect in materials and/or workmanship under normal use for a period of 24 months. Subject to the following: -

- The warranty period commences from the date of purchase by the original purchaser from an authorised EvaKool dealer.
 - EvaKool will honour this warranty on presentation of proof of purchase of the unit to EvaKool or its approved service agent. The service agent may be requested to provide EvaKool with a photocopy of the proof of purchase to obtain approval to proceed prior to warranty being honored.
 - Evakool will not be held responsible for any costs incurred in making a warranty claim.
 - Please telephone (07) 5492 7777 for the name of an authorized service agent or refer to list provided. It is the purchaser's responsibility to freight the unit to and from the service agent.
 - EvaKool will not be held responsible for any damage or loss suffered or cost incurred whilst fridge is in transit.
 - Warranty repairs may only be carried out by an authorised service agent. EvaKool will not reimburse repair claims carried out by unauthorized service agents. Any unauthorized tampering with any part of the unit will automatically void the warranty.
 - Service agents may charge a fee for viewing or testing the unit. This is not covered by EvaKool or this warranty and is payable at the service point unless authorized by EvaKool.
 - Any Evakool authorized service centre in Australia will be able to carry out the service of your unit. If a repair needs to be undertaken and is covered in terms of this warranty a warranty authorization number must be obtained prior to commencement of any work.
 - **EvaKool will not accept a warranty claim if:**
 1. Modifications have been carried out to the unit without EvaKool's written authority.
 2. Damage to or failure of the unit has been caused in EvaKool's opinion by incorrect, extreme or unreasonable use.
 3. Damage to or failure of the unit has been caused in EvaKool's opinion by misuse, neglect, accident, impact or similar cause. Refer the preventative maintenance guidelines.
 - EvaKool has total discretion on the variation of the warranty terms.
 - Our goods come with guarantees that cannot be excluded under the Australian Consumer Law. You are entitled to a replacement or refund for major failure and for compensation for any other reasonably foreseeable loss or damage. You are also entitled to have the goods repaired or replaced if the goods fail to be of acceptable quality and the failure does not amount to a major failure.
 - The above warranty conditions are in addition to any other rights and/or remedies as per the applicable law.
 - Failure to follow the guidelines/recommendations in this manual may void the warranty.
 - This warranty cannot be varied by others.
- COMPLETE THE ENCLOSED WARRANTY CARD AND RETURN WITHIN THIRTY (30) DAYS OF PURCHASE
- POST or Register your product warranty**
- ONLINE at www.evakool.com**



By Evakool

Instruction Manual
