

# EVAKOOL®

## DOWN UNDER SERIES

# INSTRUCTION MANUAL

FOR MODELS

DU95-DZ

DU75-DZ



# CHILLED FOR GOOD TIMES



**Please read operating manual carefully before using your unit.**

**Please keep manual in a safe place.**

**If lost you can find a digital copy at [Evakool.com.au](http://Evakool.com.au) or contact Evakool on 1300 385 665 (1300 EVKOOL).**

## **Contents**

1	Safety Instructions .....	4
2	Notes on Using the Product .....	4
3	Operation .....	5
4	Connecting the Refrigerator .....	8
5	Error Codes .....	9
6	Preventative Maintenance & Care .....	10
7	Troubleshooting .....	11
8	Product Data .....	13
9	Product Drawings .....	14
10	Warranty Statement .....	16

## **What's in the Box:**

- 1 x Fridge
- 1 x 1.8m Anderson to Anderson style 12V plug
- 1 x 12V to 240V adaptor
- 3 x Baskets

## **Key Product Features**

- World renowned Secop compressor.
- Highly efficient rollbond evaporator.
- Multi-voltage system (DC12-24 Volts) and 240AC adaptor (included).
- Digital battery protection – protects vehicle battery.



## 1 Safety Instructions

- Warning: Do not touch exposed cables.
- Warning: Do not use fridge if you suspect any connections could be wet.
- When using the fridge in a vehicle, please ensure the circuit being used is fused at the battery or power source at the recommended size.
- Any installation of DC power systems should be handled by a qualified professional.
- Make sure the source voltage is correct. The technical data label (page 13) has the voltage data.
- Do not place any electrical devices inside the refrigerator as moisture could harm these devices.

## 2. Notes On Using The Product

- Your refrigerator requires good ventilation, especially around the vents of the refrigerator; allow a gap of at least 200mm around the vents.
- Avoid humidity: humidity inside the appliance can form frost and impair cooling. Do not allow frost to build up.
- Never clean the appliance using a hose and never submerge the unit in any liquid.
- Avoid placing your refrigerator near a heat source. This helps the refrigerator to work more efficiently and keep the contents cool.
- Place the refrigerator on a flat surface and away from any edges. When using the fridge in a vehicle, please use a fastening device to secure it.
- This product is not designed for marine purposes and warranty may become void if corrosion or rust is caused by sea salt.

### **Helpful Hints**

*To ensure maximum performance from your Evakool Down Under Fridge/Freezer, please read the following helpful hints.*

- *Read this instruction manual thoroughly, prior to operation.*
- *Pre-chill your fridge before use. This will allow your fridge to achieve the desired temperature quicker.*
- *Clean your fridge regularly to avoid frosting of the cooling plates and ensure the condenser is free of dust and lint.*
- *Do not store any electrical equipment inside the fridge after use.*

**RECOMMENDED TEMPERATURE SETTINGS**

Fridge	2°C
Freezer	-16°C

**COMPRESSOR SPEED SETTINGS**

Eco	Recommended for ambient temperatures of 30°C or less.
Max	Recommended for ambient temperatures of 30°C or more.

**For Maximum Efficiency**

- Use the included baskets to ensure air circulation freely around the cabinet.
- Ensure the vents are not obstructed as to allow maximum airflow.
- Refrain from unnecessary opening of the unit.

### 3. Operation

- **Power:** The refrigerator can be powered by a multi-voltage system utilising either 12/24 Volts or with the included 240V adaptor. The electronic module controls the compressor and has the added function of a three stage battery protection. When the input voltage drops below the minimum, the compressor will cut out; when the voltage comes back up to the cut-in value, the compressor will restart automatically.
- **Battery Protection:** The SECOP compressor requires approximately 11.0 Volts (12 Volt System) or 23.0 Volts (24V System) to operate. If the voltage drops below this the fridge will stop running.
- **Cable Specification:** The DC cables must have a suitable cross-section for their length (measured from the battery to the unit), according to this table:

Cable Thickness (Area)		12V Max Cable Length		24V Max Cable Length	
(mm <sup>2</sup> )	AWG	(m)	(ft)	(m)	(ft)
2.5	13	2.5	8	5	16
4	11	4	13	8	26
6	9	6	20	12	39
10	7	10	33	20	66

## LED Control Panel

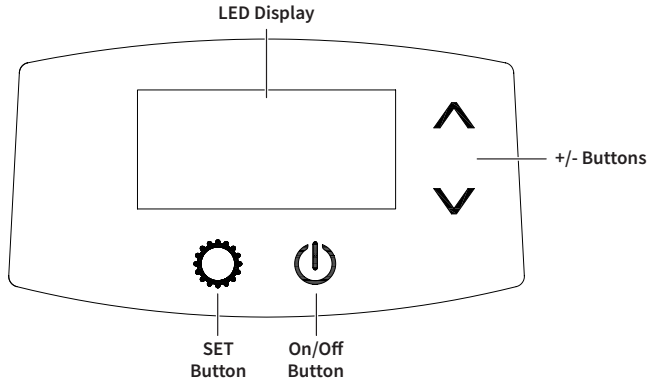



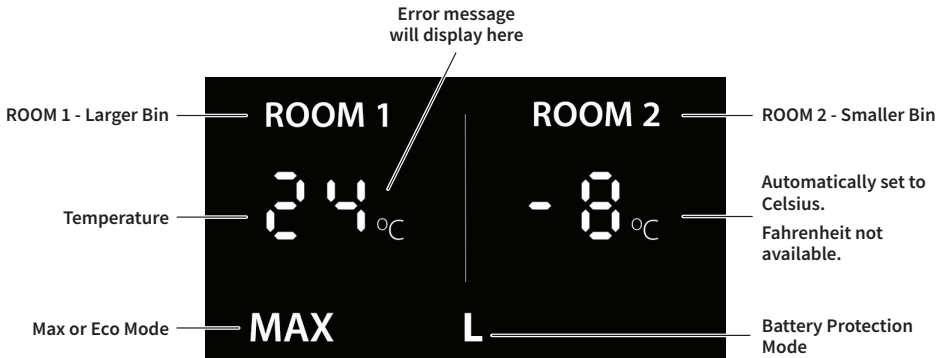

### 1. Display





### 2. To turn on/off the refrigerator:

- Hold the  button for one to two seconds.



### 3. Setting the temperature:

- To set Room 1 press  button once.
- To set Room 2 press  button twice.
- Once the selected room is flashing use the  or  buttons to select the temperature.
- After a few seconds, the selected temperature will automatically set.

#### 4. Setting the Max or Eco mode:

- Press the  button 3 times.
- Use the  or  buttons to select mode.
- After a few seconds, the selected mode will automatically set.

#### 5. Setting the battery protection mode:

- Press the  button 4 times.
- Use the  or  buttons to select the battery protection mode. Modes available:
  - Low
  - Medium
  - High
- After a few seconds the selected mode will automatically set.

**NOTE:** When the power to the refrigerator is supplied by the starter battery of a car, select battery mode “H”. If the fridge is connected to an auxiliary, the battery protection mode “L” will suffice. If you wish to operate the fridge from an AC power supply, set the battery mode to “L”.

#### 6. Selecting a compartment:

If you only require cooling for a small amount of product, you can switch OFF either side and run just one compartment.

- Press and hold the UP arrow for 3 seconds this will turn OFF the large bin. Reverse the procedure to turn back ON.
- Press and hold the DOWN arrow for 3 seconds this will turn OFF the smaller or stepped bin. Reverse the procedure to turn back ON.

**Note:** The temperatures displayed on your fridge are only an indication of what temperature may be inside the fridge.

## 4. Connecting the Refrigerator

### Connecting to a battery

- The fridge can be operated with 12V or 24V.
- Note: disconnect the fridge (and other consumer units) from the battery before you connect the battery to a quick charging device. Over voltage can damage the electronics of the device.
- For safety reasons the refrigerator is equipped with an electronic system to prevent polarity reversal. This protects the fridge against short-circuiting when connected to a battery.
- Plug the 12/24V connection cable into the Anderson style inlet plug, then plug it into the 12/24V power socket.

### Connecting to 240V AC power supply

- Connect Anderson style plug to the power supply.
- Turn on the power at the outlet and then the refrigerator.
- **Danger:** Never handle plugs and switches with wet hands or if you are standing on a wet surface.

### Using the battery protection mode

- This device is equipped with a multi-level battery monitor that protects your vehicle battery against excessive discharging when the device is connected to the on-board 12/24V supply.
- If the refrigerator is operated when the vehicle's ignition is switched off, the fridge switches off automatically as soon as the supply voltage falls below a set level. The fridge will switch back on once the battery has been recharged to the restart voltage level.

Battery Protection Mode	L	M	H
Switch-off voltage at 12V	10.1V	10.5V	11.1V
Restart voltage at 12V	10.9V	11.4V	12.4V
Switch-off voltage at 24V	21.5V	22.3V	24.3V
Restart voltage at 24V	22.7V	23.7V	25.7V



## 5. Error Codes

Code	Reason / Solution
E1	<p><b>Low Voltage</b></p> <ul style="list-style-type: none"> <li>• Please check the source voltage to ensure it is above the cut out. Try lowering the voltage cut out setting to LOW (refer to page 7).</li> <li>• The vehicle cabling may be inadequate/unsuitable, please refer to cable specifications table for correct cable thickness (page 5).</li> <li>• Try on a different power source.</li> </ul>
E2	<p><b>Fan Issue</b></p> <ul style="list-style-type: none"> <li>• Fan is drawing too many Amps (Over 1 Amp).</li> </ul> <p>- Contact EvaKool</p>
E3	<p><b>Compressor Start Issues</b></p> <ul style="list-style-type: none"> <li>• Unplug for 10 minutes.</li> <li>• Try on a different power source.</li> <li>• Possible compressor module fault.</li> </ul> <p>- Contact EvaKool</p>
E4	<p><b>The Compressor Speed is Too Low</b></p> <ul style="list-style-type: none"> <li>• Unplug for 10 minutes.</li> <li>• Move unit to a lower ambient temperature.</li> <li>• Clean vents / ensure clear air flow over compressor.</li> <li>• Reduce product load inside unit.</li> </ul>
E5	<p><b>Ambient Temperature Too High</b></p> <ul style="list-style-type: none"> <li>• Clean vents / ensure clear air flow.</li> <li>• Fan fault.</li> </ul> <p>- Contact EvaKool</p>
E6	<p><b>Thermistor is Unplugged</b></p> <p>- Contact EvaKool</p> <p><b>Thermistor is Short Circuited</b></p> <p>- Contact EvaKool</p>

## 6. Preventative Maintenance & Care: Metal & Injection Moulded Products

To ensure a long life and reliable operation of your metal and injection moulded fridge/freezer we recommend following our preventative maintenance and care guide.

### Cabinet Care

- The cabinet should be cleaned after every use by wiping both the interior and exterior with a damp cloth, using a mild non-abrasive detergent, and dry thoroughly. The painted metal surfaces can be polished with a car polish and a soft cloth.  
*\*To protect the cabinet from the harsh conditions a protective cover can be purchased from EvaKool's online store (<http://www.evakool.com.au/>) or selected retail outlets.*
- **Do not use** scourers, harsh cleaning products, solvents, or oil as this will degrade the plastic and can cause damage to painted surfaces.
- **Do not** leave the cabinet in direct sunlight as this may cause discolouration in the plastic and painted surfaces. Please note: plastic components in all EvaKool fridge/freezers are UV stabilised.

### Defrosting

- After use, defrost ice off evaporator; switch off unit and disconnect from power source. Leave the lids open to naturally melt the ice. Once the ice has melted, ensure the unit is completely dry by draining any residue and wiping down with a towel.
- Always make sure the cabinet is completely dry and the lid left ajar when put in storage. This will ensure no corrosion, mold or odor will form inside the cabinet.
- **Do not** store electrical devices such as the 12 volt adaptor inside the refrigerator.

### Refrigerator Maintenance

- As your EvaKool fridge is a portable appliance it is subjected to a variety of different operating conditions. Every 12 months of use, a general inspection and maintenance should be carried out. We recommend the inspection to be carried out by an approved EvaKool agent. Our service agents can be found via our website <https://www.evakool.com.au/stores?type=2>.

### Marine Use

- We do not recommend the use of our fridges in a marine environment, as salt can cause corrosion in electronics and metal components. If unit failure is found to be caused by corrosion, warranty will be void.

## 7. Troubleshooting

### The appliance is not turning on

- Check the power supply.
- Check whether the plug and the socket have a good connection.
- If you have purchased an additional 12V adaptor with a cigarette end, check whether the fuse requires replacing. This is located inside the cigarette end of the 12V adaptor. Follow the 'Replacing the fuse plug' section at the bottom of page 11 if you require a new fuse.
- Check whether the appliance has been turned on (refer to page 6).
- Check the circuit breaker, this is located to the left of the motor cover. If the circuit breaker button has popped out, press it back in.

### The food inside is frozen

- The set temperature is too low.

### Bad performance in refrigeration

- The temperature setting is inappropriate.
- The lid is unlocked/or open.
- The lid seal is broken.
- Problems arising from poor ventilation.
- There is too much food inside the refrigerator.
- There is too much warm product inside the refrigerator.
- There is a heat source near the unit.

### Hear the sound of water from inside the unit

- This is normal, due to the flow of the refrigerant.

### Unusual noise when refrigerator is working

- The refrigerator is not placed on a level surface.
- Some part has come loose inside the refrigeration compartment (see a service agent).

### Replacing the fuse plug (12/24V)

**NOTE:** An Anderson to cigarette adaptor is not included with this product and can be purchased separately via our website.

- You can purchase a fuse from any automotive or electrical retailer near you. The required replacement part is a 10 Amp glass fuse.
- Pull off the adaptor sleeve on the plug.

- Unscrew the screw from the upper half of the housing.
- Carefully raise the upper half of the housing from the lower half.
- Take out the contact pin.
- Replace the defective fuse with a new one that has the same rating (10A, 250V).
- Re-assemble the plug in the reverse order.

### **Replacing the PCB (display) light**

- If you require a new PCB light please contact Evakool on 1300 385 665.  
Spare part code: LED-DU.
- The PCB light is located internally on the outer left and right hand sides.
- Disconnect the power supply.
- Carefully pry out the plastic light cover with a pointed and flat tool.
- Unscrew the PCB mounting screws.
- Pull out the PCB.
- Replace them with a new PCB.
- Fit the screws in with a screwdriver.
- Press the transparent part of the lamp back into the housing.
- Connect the power supply to the fridge.

*If none of the above solves your issue please contact Evakool on 1300 385 665 or [warranty@evakool.com.au](mailto:warranty@evakool.com.au) for details of your closest Evakool service centre.*

## 8. Product Data

SPECIFICATIONS			
Model No.		DU75-DZ	DU95-DZ
<b>Basic Data</b>			
Type		DC + Adaptor	
Cooling $\Delta T$	°C	43°C	
Temperature Range Refrigeration	°C	+10°C to -18°C	
Gross Capacity	L	75	95
Power Supply	V	DC 12/24V	
Rated Current DC	A	5.4A/2.7A	
Rated Power Input	W	65	
Sound Noise Level	dB	45	
Foaming Thickness	mm	50	
Temperature Control		Digital Control (NTC)	
<b>Refrigerating System</b>			
Compressor Brand		SECOP PCB 2.5	
Refrigerant Type		R134a	
Refrigerant Charging	g	60	65
<b>Packing Information</b>			
Net Weight	kg	30	33
Product Dimension (L*W*H)	mm	895.7*473.8*530	966.3*575*470
<b>Certificates</b>			
CE		✓	✓
CB		✓	✓
SAA		✓	✓
KC		✓	✓
PSE		✓	✓

## 9. Product Drawings

### DU75

#### Dimensions

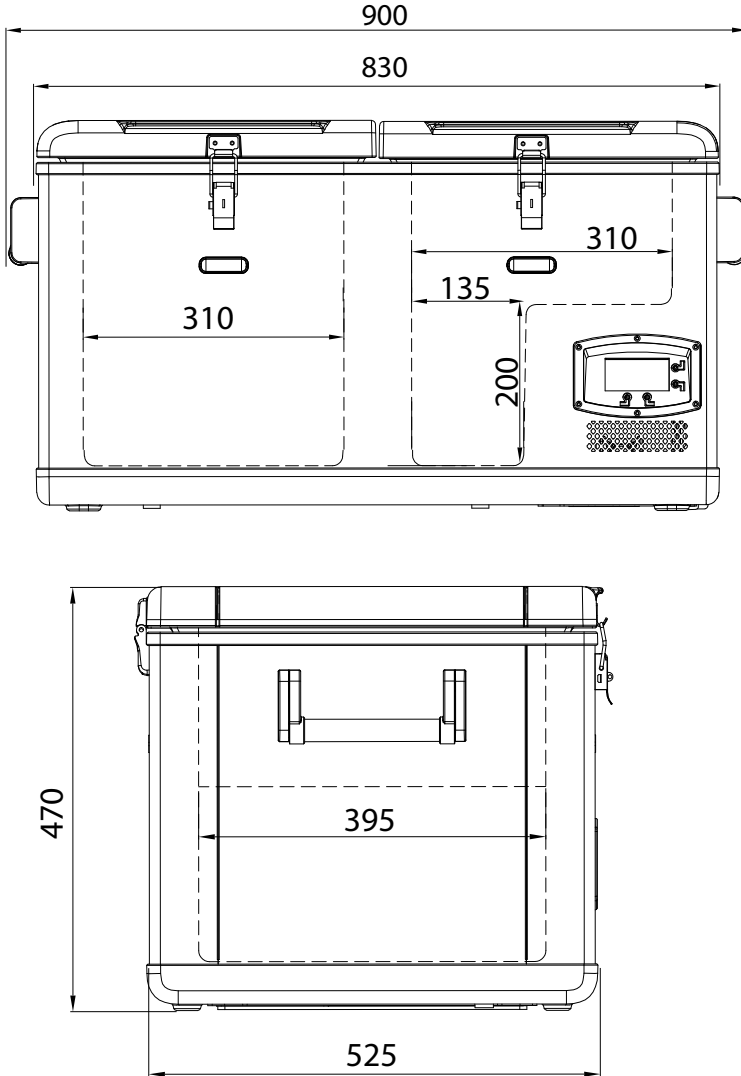

## DU95

### Dimensions

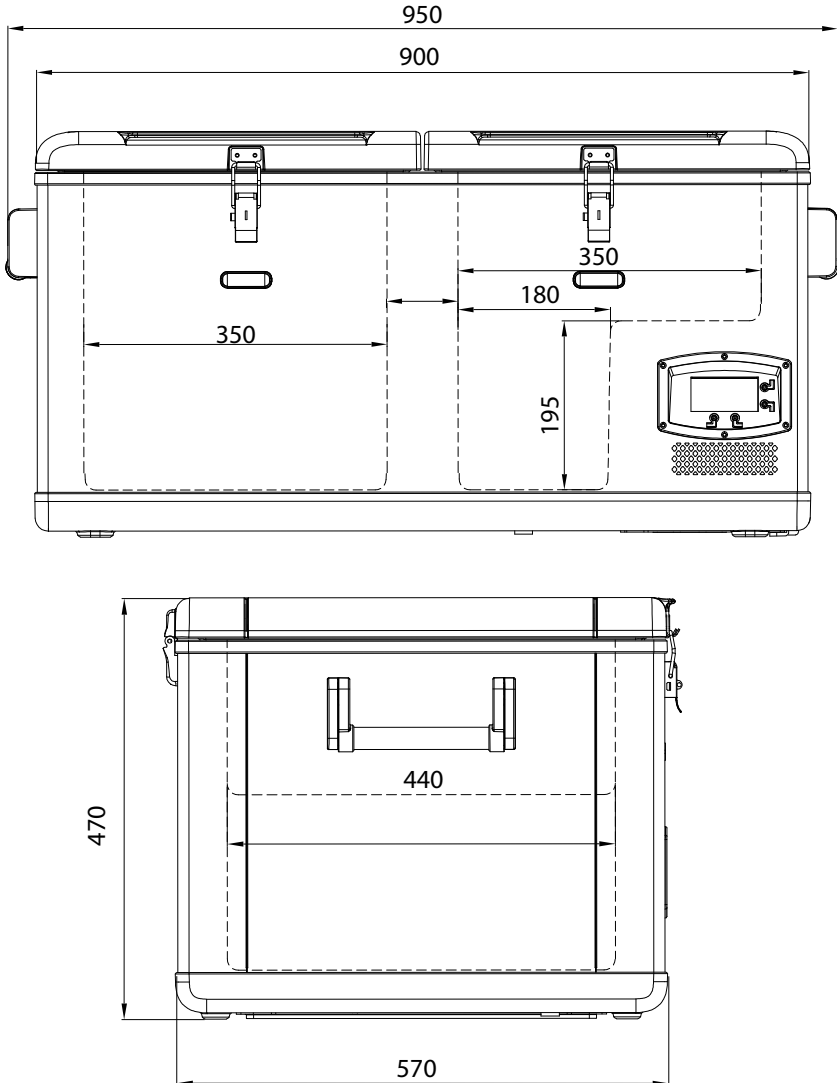

## 10. Warranty Statement/Terms & Conditions

Nexberg Pty Ltd trading as EvaKool undertakes to the original purchaser that this product is sold free of defect in materials and/or workmanship under normal use for a period of **3 years**. Subject to the following:

- The warranty period commences from the date of purchase by the original purchaser from an authorised EvaKool dealer.
- The Secop compressor in this unit carries a **5 year** warranty under normal use.
- EvaKool will honour this warranty on presentation of proof of purchase of the unit to EvaKool or its approved service agent. The service agent will be requested to provide EvaKool with a photocopy of the proof prior to warranty being honoured.
- EvaKool will not be held responsible for any costs incurred in making a warranty claim.
- Please telephone 1300 385 665 for the name of an authorised service agent or refer to list provided on website (<https://www.evakool.com.au/stores?type=2>). It is the purchaser's responsibility to freight the unit to and from the service agent.
- EvaKool will not be held responsible for any damage or loss suffered or cost incurred whilst fridge is in transit.
- Warranty repairs may only be carried out by an authorised service agent. EvaKool will not reimburse repair claims carried out by unauthorised service agents. Any unauthorised tampering with any part of the unit will automatically void the warranty.
- Service agents may charge a fee for viewing or testing the unit. This is not covered by EvaKool or this warranty and is payable at the service point unless authorised by EvaKool.
- Any EvaKool authorised service agent in Australia will be able to carry out the service of your unit. If a repair needs to be undertaken and is covered in terms of this warranty a warranty authorisation number must be obtained prior to commencement of any work.
- This warranty does not extend to any products acquired for the purposes of re-supply, to be used up or transformed in a production or manufacture process or in repairing other goods.
- This fridge is intended for recreational use only. If used for commercial use, a 12 month warranty applies.
- To the extent permitted by law, this warranty does not extend to any claim for damages that you or any other person may have for any loss (including without limitation consequential damages or loss of profit) or damage howsoever caused.
- **EvaKool will not accept a warranty claim if:**
  1. Modifications have been carried out to the unit without EvaKool's written authority.
  2. Damage to or failure of the unit has been caused in EvaKool's opinion by incorrect, extreme or unreasonable use.
  3. Damage to or failure of the unit has been caused in EvaKool's opinion by misuse, neglect, accident, impact or similar cause. Refer to the preventative maintenance guidelines.
- EvaKool has total discretion of the variation of the warranty terms.
- Our goods come with guarantees that cannot be excluded under the Australian Consumer Law. You are entitled to a replacement or refund for major failure and for compensation for any other reasonably foreseeable loss or damage. You are also entitled to have the goods repaired or replaced if the goods fail to be of acceptable quality and the failure does not amount to a major failure.
- The above warranty conditions are in addition to any other rights and/or remedies as per the applicable law.
- Failure to follow the guidelines/recommendations in this manual may void the warranty.
- This warranty cannot be varied by others.

***Please retain your receipt or proof of purchase for warranty purposes. You can register your warranty online at [www.evakool.com.au](http://www.evakool.com.au) under contact us and register product warranty.***









# EVAKOOL®

## CHILLED FOR GOOD TIMES

For your nearest stockist contact Evakool

T: 1300 385 665 (1300 EVKOOL)

E: [sales@evakool.com](mailto:sales@evakool.com)

[evakool.com.au](http://evakool.com.au)

For Service and Warranty support contact Evakool

T: 1300 385 665 (EVKOOL)

E: [warranty@evakool.com](mailto:warranty@evakool.com)