

Copyright © TALKPOD TECHNOLOGY CO., LTD 2021. All rights reserved.

No part of this document may be reproduced or transmitted in any form or by any means without prior written consent of Quanshun Communication And Technology Co., Ltd.

TRADEMARK NOTICE

 Talkpod, 拓朋 are trademarks or registered trademarks of Quanshun Communication And Technology Co., Ltd. Other trademarks, product, service and company names mentioned are the property of their respective owners.

NO WARRANTY

This document may contain forecast information, including but not limited to information about product families, new technologies, etc.

There are many uncertain factors in practice, which may lead to the difference between the actual information and the forecast information big difference.

Therefore, the information in this document is for reference only and does not constitute any offer or acceptance. Talkpod The above information may be modified without notice.



Talkpod is committed to developing products that help protect the environment.



TALKPOD TECHNOLOGY CO., LTD.

4#419 Saige Tech. Park, Zhenxing Road, Futian District,
Shenzhen, People's Republic of China 518000

www.talkpod.com



N59 PoC Portable Radio User Manual

Thanks for your favor in our product.
This manual is helpful for you to quickly know how to use the product.

This manual is applicable to the following product:
N59 PoC Portable Radio

Contents

General information		Assemble Antenna	05
Preface	01	Assembling the Belt Clip	06
Disclaimer	01	Assembling the Accessories	06
RF Radiation Information	01	Charge the radio	06
RF Radiation Profile	01	LED Indicator	07
RF Radiation Safety	02	Powering On/Off	07
Operational Instructions and Training Guidelines	02	Button Details	08
EU Regulatory Conformance	02	Channel Selection Button	08
		Side Buttons	08
Basic Operation And Installation		PTT Buttons	09
Radio Structure	03	Product Care	09
Radio Packing	03		
Button Details	04	Troubleshooting	10
Specifications	04	Optional Accessories	12
Attach Battery	05		

General information

Preface

Thanks for your favor in our product. This manual is helpful for you to quickly know how to use the product.

This manual is applicable to the following product: N5X PoC Portable Radio (X may represent 0–9)

Disclaimer

Talkpod Technology Co., Ltd. (the Company) endeavors to achieve the accuracy and completeness of this manual, but no warranty of accuracy or reliability is given. All the specifications and designs are subject to change without notice due to continuous technology development. No part of this manual may be copied, modified, translated, or distributed in any manner without the express written permission of us. We do not guarantee, for any particular purpose, the accuracy, validity, timeliness, legitimacy or completeness of the Third Party products and contents involved in this manual.

If you have any suggestions or would like to learn more details, please visit our website at www.talkpod.us.

RF Radiation Information

The radio is not intended for use by general population in an uncontrolled environment. It is only for occupational use and only applied to work-related conditions.

The radio must be only used by users, who are fully aware of the hazards of the exposure and who are able to exercise control over their RF exposure to qualify for the higher exposure limits.

RF Radiation Profile

Radio Frequency (RF) is a frequency of electromagnetic radiation in the range at which radio signals are transmitted. RF technology is widely used in communication, medicine, food processing and other fields. It may generate radiation during use.

RF Radiation Safety

In order to ensure user health, experts from relevant industries including science, engineering, medicine and health work with international organizations to develop standards for safe exposure to RF radiation. These standards consist of:

- United States Federal Communications Commission, Code of Federal Regulations; 47CFR part 2 sub-part J;
- American National Standards Institute (ANSI)/Institute of Electrical and Electronic Engineers (IEEE) C95. 1-1992;
- Institute of Electrical and Electronic Engineers (IEEE) C95. 1 – 1999;
- International Commission on Non-Ionizing Radiation Protection (ICNIRP) 1998;

Operational Instructions and Training Guidelines

To ensure optimal performance and compliance with the occupational/controlled environment RF energy exposure limits in the above standards and guidelines, users should transmit no more than 50% of the time and always adhere to the following procedures:

- RF energy will be generated only when the radio is transmitting.
- The radio must be 2.5 centimeters away from human body when transmitting.

EU Regulatory Conformance

As certified by the qualified laboratory, the product is in compliance with the essential requirements and other relevant provisions of the Directive 1999/5/EC.

Please note that the above information is applicable to EU countries only.



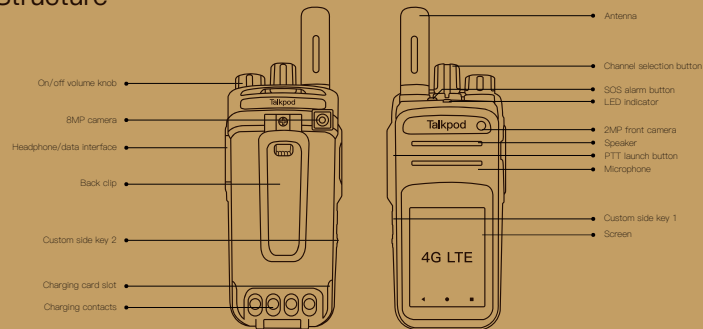

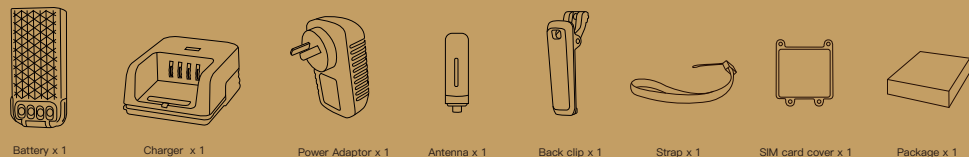

1. Radio Structure



2. Radio Packing



3. Button Details

NO	Icon	Name	Description
1		LED Light	Green: RX Red: TX
2		PTT	Press to Talk
3		Side Button 1	Programable Side button
4		Side Button 2	Programable Side button (Better use Long press S2 for SOS)
5		Accessory Jack	For Headsets, Program Cable
6		Power/Volume Knob	Turn clockwise to power on and increase the volume Turn counterclockwise to power off the power and decrease the volume
7		SOS button on the top	One click on SOS alarm

4. Specifications

Version Information		General Specifications						
Model Name	N69	Battery Capacity	7.4V 1650/3000mAh Li-Ion Battery					
A-A4-E18 For Europe	2G:GSM850/900/1800/1900	Sensitivity	-106dBm					
	3G:G1/2/5/8	GPS	Default					
	TDD:G34/35 CDMA2000: BC0	SIM Card Slot	1xStandard SIM+1 Nano SIM					
A-A4-E19 For US	4G:G1/3/5/7/8/18/19/20/ 28A/28B	Antenna Impedance	50Ω					
	TDD:G34/38/39/40/41	Dimensions	115x56x32 (mm)					
	2G:GSM850/900/1800/1900	Weight	260g/9.17oz					
3G:G1/2/4/5/8	<table border="1"> <thead> <tr> <th colspan="2">Certification</th> </tr> </thead> <tbody> <tr> <td>CE FCC & IC ID</td> <td>FCC 2A/QZTP4GNX</td> </tr> <tr> <td>Dustproof and waterproof</td> <td>IP54(Standard)/IP68(Optional)</td> </tr> </tbody> </table>		Certification		CE FCC & IC ID	FCC 2A/QZTP4GNX	Dustproof and waterproof	IP54(Standard)/IP68(Optional)
Certification								
CE FCC & IC ID	FCC 2A/QZTP4GNX							
Dustproof and waterproof	IP54(Standard)/IP68(Optional)							
4G:G1/2/3/4/5/7/12/13/ 17/25/26/27								

The above specifications are tested according to applicable standards. Due to the continuous development of technology, the above index data is subject to change without notice.

5. Attach Battery

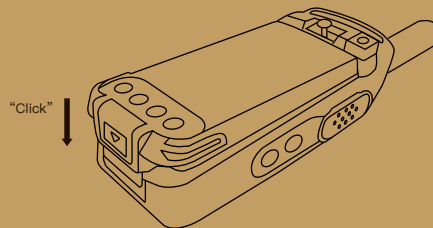

Note

- Turn off the radio before removing the battery.
- If not assembled with battery specified by Talkpod, the radio will give alarm tone to remind you when powering on. Afterwards, it will operate normally.

6. Assemble Antenna

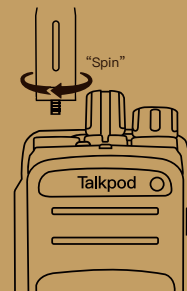

Note

- Do not swing the radio when holding it by the antenna, so as to avoid lowering the performance and shortening the life span of the antenna.

7. Assembling the Belt Clip

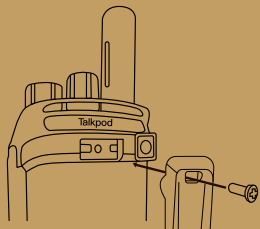

8. Assembling the Accessories

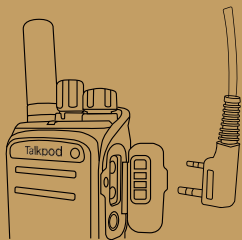

9. Charge the radio

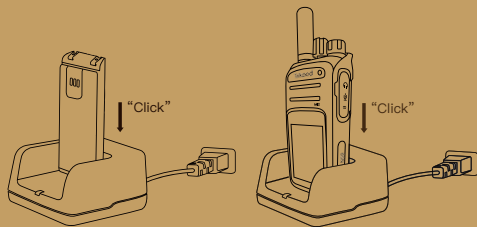

Charging Status		
* Blinking Red	- [Battery Icon with X] -	Unchargeable Waiting to charge.(Either the battery Voltage is too low or the battery temperature is to low or too high to allow charging.When this condition is corrected,the battery will automatically begin charging.)
* Blinking Orange	- [Battery Icon with 1 bar] -	
• Steady Red	- [Battery Icon with 2 bars] -	Rapid Charging
* Blinking Green	- [Battery Icon with 3 bars] -	Charged(90% capacity)
• Steady Green	- [Battery Icon with 4 bars] -	Fully Charged

10. LED Indicator

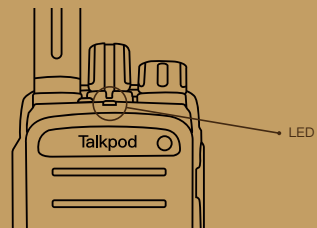

LED Status	Product Status
Steady Green	Receiving
Steady Red	Transmitting

11. Powering On/Off



12. Button Details



13. Channel Selection Button



According to different models or interfaces, you can use the knob to select a group, member, friend, or function.

14. Side Buttons

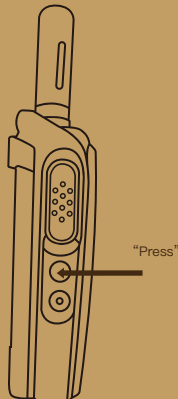

According to different models and user habits, side buttons can be set to group/member/friend selection, SOS or to broadcast current groups.

15. PTT Button

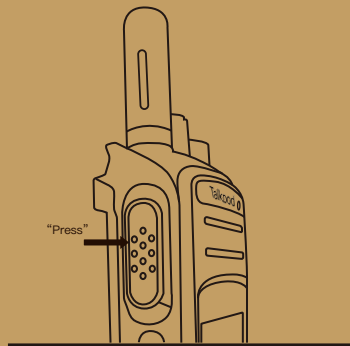

In different interfaces, press PTT button to make group call, single call, private call.

16. Product Care



Do not pierce or scrape the product with any edged instruments or hard objects.



Keep the product far away from substances that can corrode the circuit.



Do not hold the product by its antenna directly.



Do not hold the product by its earpiece cable directly.



Attach the accessory jack cover when the product is not in use. Keep the product far away from substances that can corrode the circuit.

17. Troubleshooting

Phenomena	Analysis	Solution
Power-on Failure	The battery may be improperly installed.	Remove the battery and reassemble it.
	The battery power may be used up.	Remove or replace the battery.
	The battery is poorly connected due to dirtied or damaged battery contacts.	Clean the battery contacts.If the problem cannot be solved, contact your dealer or authorized service center for inspection and repair.
During receiving, the voice is weak, discontinuous or totally inactive.	Low battery voltage.	Recharge or replace the battery.
	Low volume level.	Increase the volume by rotating the Volume Control knob.
	The antenna may be loosened or improperly installed.	Reassemble the antenna after turning off the radio.
	The speaker may be blocked or damaged.	Clean the surface of the speaker.If the problem cannot be solved, contact your dealer or authorized service center for inspection and repair.
Unable to communicate with other members.	The frequency or signaling may be inconsistent with that of other members.	Set your TX/RX frequency and signaling to the same as that of other members.
	The channel type(digital/anaio)g)may be set inconsistently.	Make sure all members are on the same digital/analog channel.
	You may be interrupted by radios using the same frequency.	Change the frequency, or adjust the squelch level.

Phenomena	Analysis	Solution
Irrelevant communication or noise is heard on the channel.	You may be interrupted by radio using the same frequency.	Change the frequency, or adjust the squelch level.
	The radio may be set with no signaling.	Set signaling for all member radios to avoid inference at the same frequency.And change the signaling settings for all portable radios at the same time.
The noise is too loud.	You may be too far away from otjer members.	Move towards other members.
	You may locate in an unfavorable position.For example, your communication may be blocked by high buildings or frustarted in the underground areas.	Move to an open and flat area, and restart the radio to try again.
	You may suffer from external disturbance (such as electromagnetic interference).	Stay away from equipment that may cause interference.

18. Optional Accessories

The following items are main optional accessories for the radio. For more information of other accessories, please consult your local dealer.

Note

Use the accessories specified by Talkpod only. If not, the Company shall not be liable for any losses or damages arising out of use of unauthorized accessories.

Charger	
	4/5 Series Standard Desktop Charger 7.4V/DC12V Input
	5 Series Power Adaptor Desktop Charger(All-in-one) 7.4V/AC220V Input with US Plug
	5 Series Power Adaptor Desktop Charger(All-in-one) 7.4V/AC220V Input with Euro Plug

Battery	
	5 Series High Capacity Li-ion Battery 7.4V/3000mAh (4 Golden Contact)
	5 Series Standard Li-ion Battery With Wireless Charging 7.4V/1650mAh (4 Golden Contact)
	5 Series High Capacity Li-ion Battery With Micro-USB 7.4V/3000mAh (4 Golden Contact)

Data line / write frequency line	
	Universal USB-Micro Cable/OD3.8PVC for All Series (Charging/Data)
	Universal K Connector Program Cable for N4/N5/D4/B3
	Android K Connector Program Cable for N5 Android Series

Power Adapter	
	Power Adaptor/12V1A/US //Euro /UK/AU Plug
	Power Adaptor for Multi Unit Charger/DC14V3.5A/US/UK/EU/AU Plug
	Power Adaptor with USB Port 5V2A US Plug (Compatible with TPC06 Charging Micro-USB Cable)/US/EU/UK/AU Plug
	Power Adaptor with USB Port 5V1A US Plug (Compatible with TPC06 Charging Micro-USB Cable)/US/EU/UK/AU Plug

Multi-channel charger	
	3 Series 1X6 Straight 6 Slots Charger 8V3A-3.7V
	3 Series 3X2 type 6 Slots Charger 8V3A-3.7V

Back clip	
	5 Series Belt Clip/8.5CM

Headset	
	2-Wire Earloop with On-MIC PTT
	2-Wire D-Ring Earphone with On-MIC PTT
	2-Wire Acoustic Tube with On-MIC PTT
	Earloop with In-line Microphone
	D-Ring Earphone with In-line Microphone
	Acoustic Tube with In-line Microphone
	3-Wire Acoustic Tube Surveillance Kit (Black)
	Rotatable ear-hook type oval clip PTT headset
	Right earhook type oval clip PTT headset
	C-type ear-hook oval clip PTT headset
Ear hook + earplug type oval clip PTT headset	

Hand microphone	
	Speaker Microphone
	Speaker Microphone With Volume Control

Protective case	
	Semi-packed nylon cover / adhesive type / with oblique lanyard / small
	Semi-packed leather holster / button type / oversized iron back clip / with diagonal strap / medium
	Wearable chest bag protector / all black
	Wearable chest bag protective cover / fluorescent strip
	Waterproof bag

Packing Box	
	N5 Public Network Series Manual/Chinese/Neutral

EU Declaration of Conformity

Talkpod

In accordance with EU Directives and Regulations

Quanshun Communication Technology Co., Ltd

ADD: Quanshun Bldg., Daxiamei, Nan'an, Quanzhou, Fujian, China 362302

as the manufacturer, hereby declares under our sole responsibility that

product(s): Two Way Radio

Model name: N59 is in conformity with the essential requirements of the Radio Equipment Directive 2014/53/EU:

Radio EN 303 405 V1.1.1 (2017-05)
Article 3.2

Safety EN 62368-1: 2014 + A11: 2017
Article 3.1(a)

EMC EN 301 489-1 V2.2.3 (2019-11)
Article 3.1(b) EN 301 489-5 V2.2.1 (2019-04)

Health EN 50566:2017
Article 3.1(a)

The notified body Bay Area Compliance Labs Corp.(BACL) (EU Identification Number: 1313) performed a conformity assessment according to Annex III, Module B.

Signed on behalf of Quanshun Communication Technology Co., Ltd



(Signature of authorized person)

Name: Roger Chen

Title: Manager

Tel: +86-595-86753355 Fax: +86-595-86758299

Mail: roger@qstx.com Date: 2020-05-07