

ASSEMBLY INSTRUCTIONS & PARTS MANUAL

Standard Storage Cabinet Preassembled Model 7218 or CVD7218



RETAIN INSTRUCTIONS FOR FUTURE REFERENCE



LOAD CAPACITIES PER SHELF LEVEL EVENLY DISTRIBUTED	
UNIT SIZE	WEIGHT CAPACITY
36w x 18d	200 lbs.

GENERAL SAFETY INFORMATION

Some parts may have sharp edges. CARE must be taken when handling various pieces to avoid injury. For safety, wear a pair of work gloves when assembling or performing any maintenance on products.

LIMITED WARRANTY

Tennsco warrants goods purchased hereunder to be free of defects in materials and workmanship for a period of one (1) year from the date of shipment, hereunder. This warranty shall not apply in the event goods are damaged as a result of misuse, abuse, neglect, accident, improper application, modification or repair by persons not authorized by Seller, where goods are damaged during shipment, or where the date stamps on the goods have been defaced, modified or removed. UNLESS CONSIDERED UNENFORCEABLE OR UNLAWFUL UNDER APPLICABLE LAW:

- a. ALL IMPLIED WARRANTIES, INCLUDING BUT NOT LIMITED TO WARRANTIES OR MERCHANTABILITY AND FITNESS FOR A PARTICULAR PURPOSE ARE HEREBY EXCLUDED:
- b. BUYERS REMEDY, IF ANY, FOR ANY DEFECTIVE GOODS SHALL BE LIMITED TO A REFUND BY SELLER OR REPLACEMENT OF THE GOODS AT SELLER'S OPTION, AND SHALL IN NO EVENT INCLUDE DAMAGES OF ANY KIND, WHETHER INCIDENTAL, CONSEQUENTIAL OR OTHERWISE.

NO GOODS ACCEPTED FOR RETURN WITHOUT PRIOR APPROVAL. Seller shall have the right to inspect any goods claimed to be defective at Buyers place of business or require Buyer to return the goods to Seller for inspection on Seller's premises. Transportation charges covering returned goods will be borne by Seller only if such goods are proven to be defective, are covered by this warranty and are returned within the warranty period stated above.



PROUDLY MADE IN THE U.S.A.

Tennsco LLC., Dickson, TN 37056-1888 • (866) 446-8686

REPLACEMENT PARTS

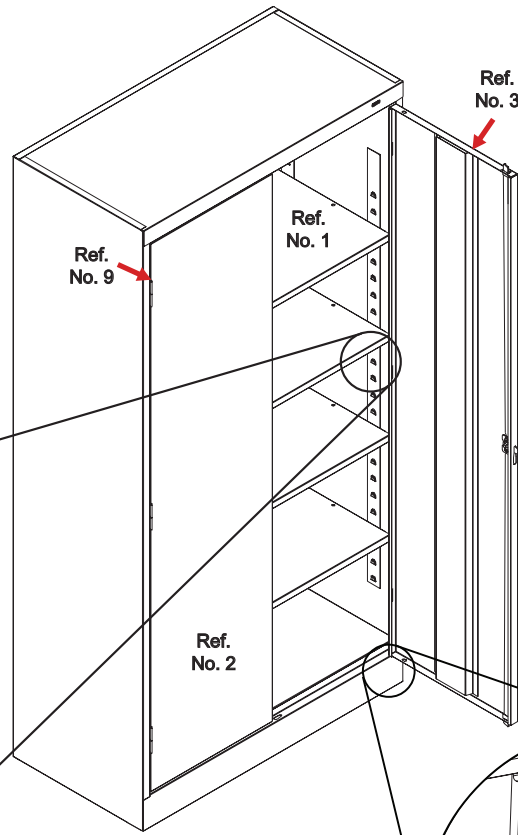
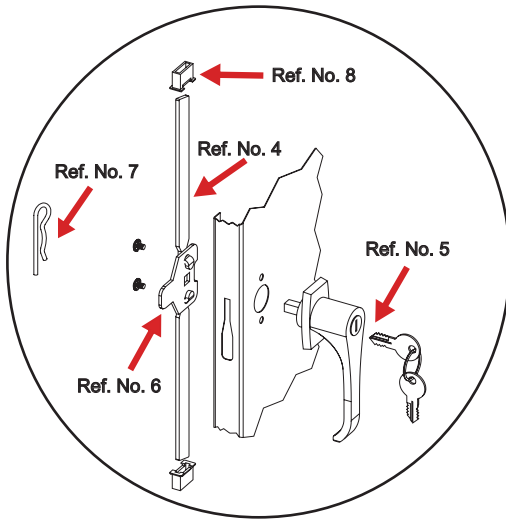

1. To move the shelf, using your hands apply pressure to the underside of the shelf and tap it off the tabs.
2. Place the shelf at the desired level. Insert the shelf edges into the tabs at the new location. Be sure that the shelf is securely fitted into the tabs at all points of contact.
3. The cabinet must be level in order for the doors to close properly. Levelers may be adjusted by placing the nut driver through the hole in each end of the sill and adjusting the leveling screw.

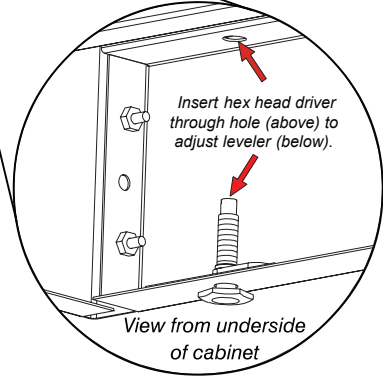
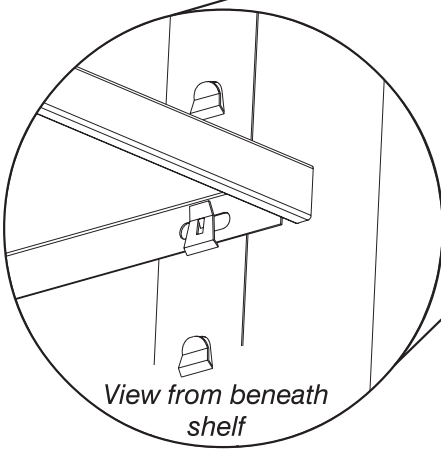

REF. NO.	DESCRIPTION	QTY.	PART NO.
1	Shelf	4	301
2	Left Door: Solid for 7218	1	944LD
	Left Door: C-Thru for CVD7218 (not shown above)	1	CVD-72LD
3	Right Door: Solid for 7218	1	944RD
	Right Door: C-Thru for CVD7218 (not shown above)	1	CVD-72RD
4	Locking Bar Set	1	944LB
5	Locking Handle w/keys & hardware	1	944LH
6	Locking Cam*	1	944LC
7	Cotter Pin*	1	CTRPN
8	Locking Bar Guide Insert (Nylon)*	2	944GI
9	Hinge Pins*	6	944HP

*Included in Ref. No. 5, locking handle with keys and hardware (Part No. 944LH). May be ordered alone or as part of the full hardware set.

NOTE: Additional hardware may be included for replacement purposes.

Tennsco makes every effort to ensure that all units ship complete with all parts and arrive undamaged. However, should your unit contain missing or damaged parts, please contact your purchase location.