

TOILET

Rimless Flushing Toilet



Cod. **DA-BL-104N-FST**
540×365×400mm

· TECHNICAL DRAWING ·

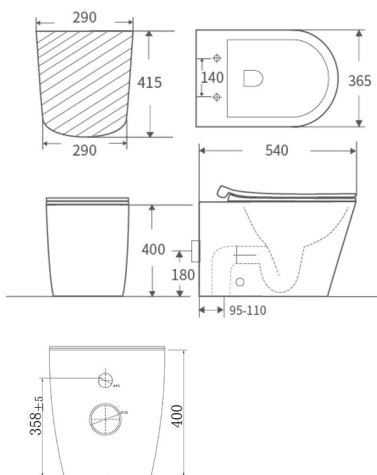

· SPECIFICATIONS ·

- Back to wall floor pan
- Self- clean glazing
- Rimless dual flush system
- Pipe glazed with antibacterial
- Universal installation – back and bottom entry
- S or P trap installation
- Water efficient 4.5/3L
- UF soft close seat cover
- For installation with the Naga in-wall cistern