

Sistema 21 - ALUMFAST SLIDE

SEZIONE VERTICALE - finestra



CLIENTE:

Nodo inferiore

scala 1:1 (A4)

data disegno 01/05/2020

data rev. --/--/----

Sp. telaio 65mm

Sp. anta 68mm

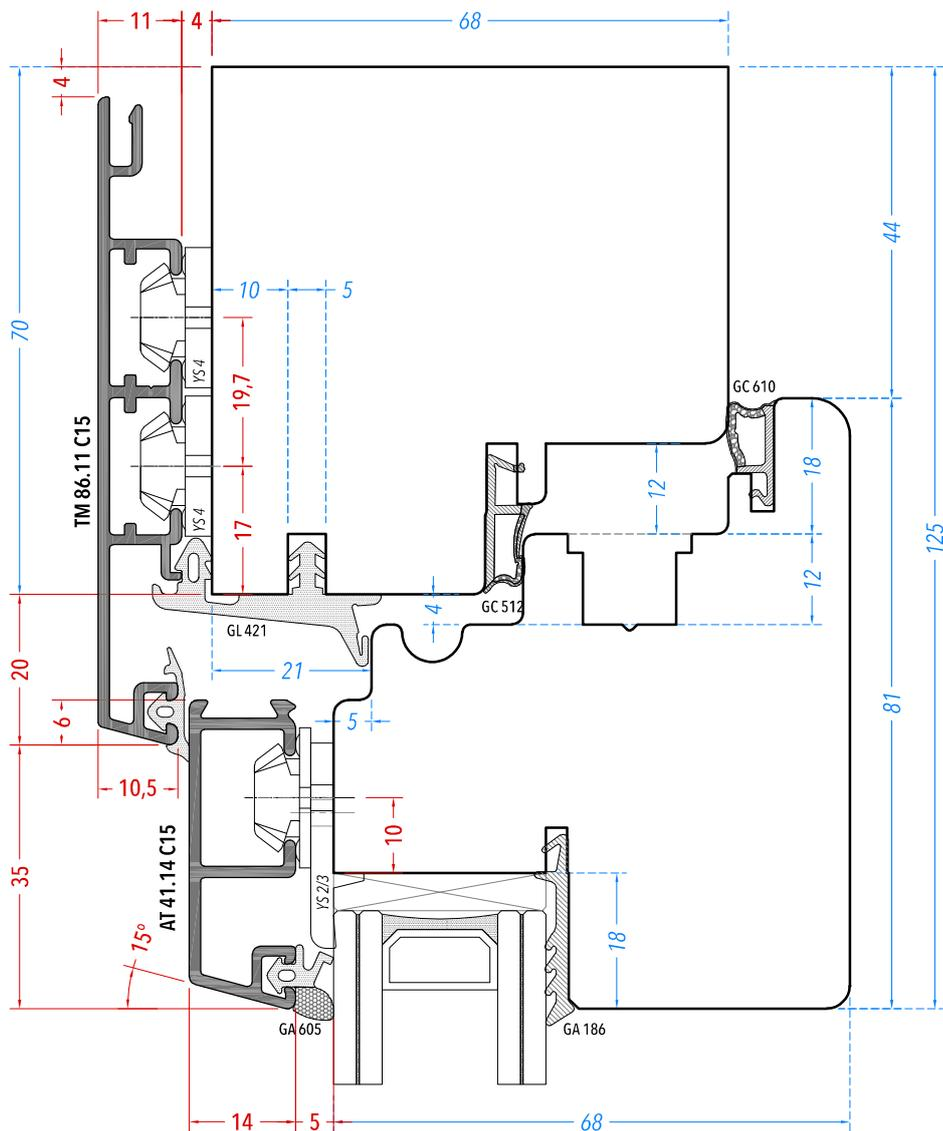
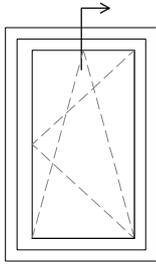

Sistema 21 - ALUMFAST SLIDE

SEZIONE VERTICALE - finestra



CLIENTE:

Nodo superiore

scala 1:1 (A4)

data disegno 01/05/2020

data rev. --/--/----

Sp. telaio 65mm

Sp. anta 68mm

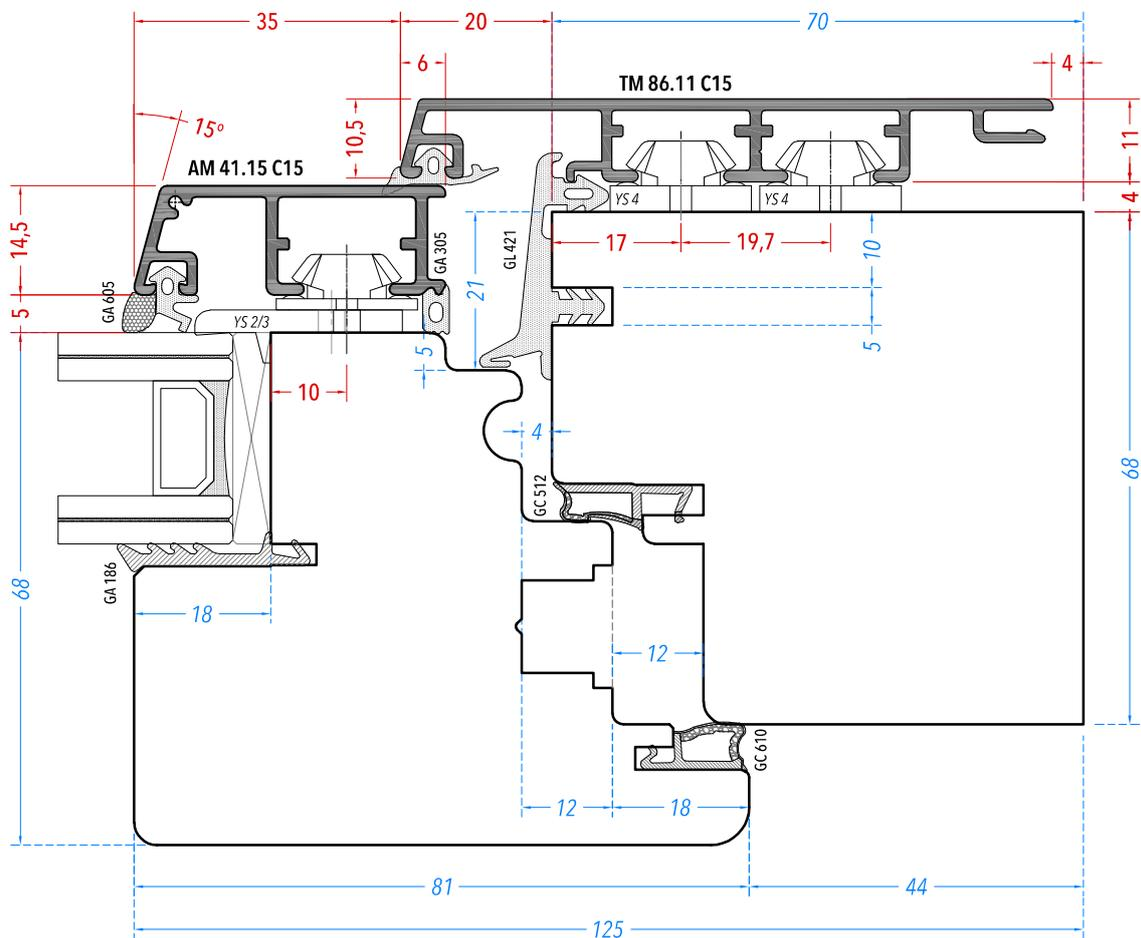
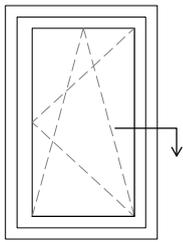

Sistema 21 - ALUMFAST SLIDE

SEZIONE ORIZZONTALE - finestra



CLIENTE:

Nodo laterale

scala 1:1 (A4)

data disegno 01/05/2020

data rev. --/--/----

Sp. telaio 65mm

Sp. anta 68mm

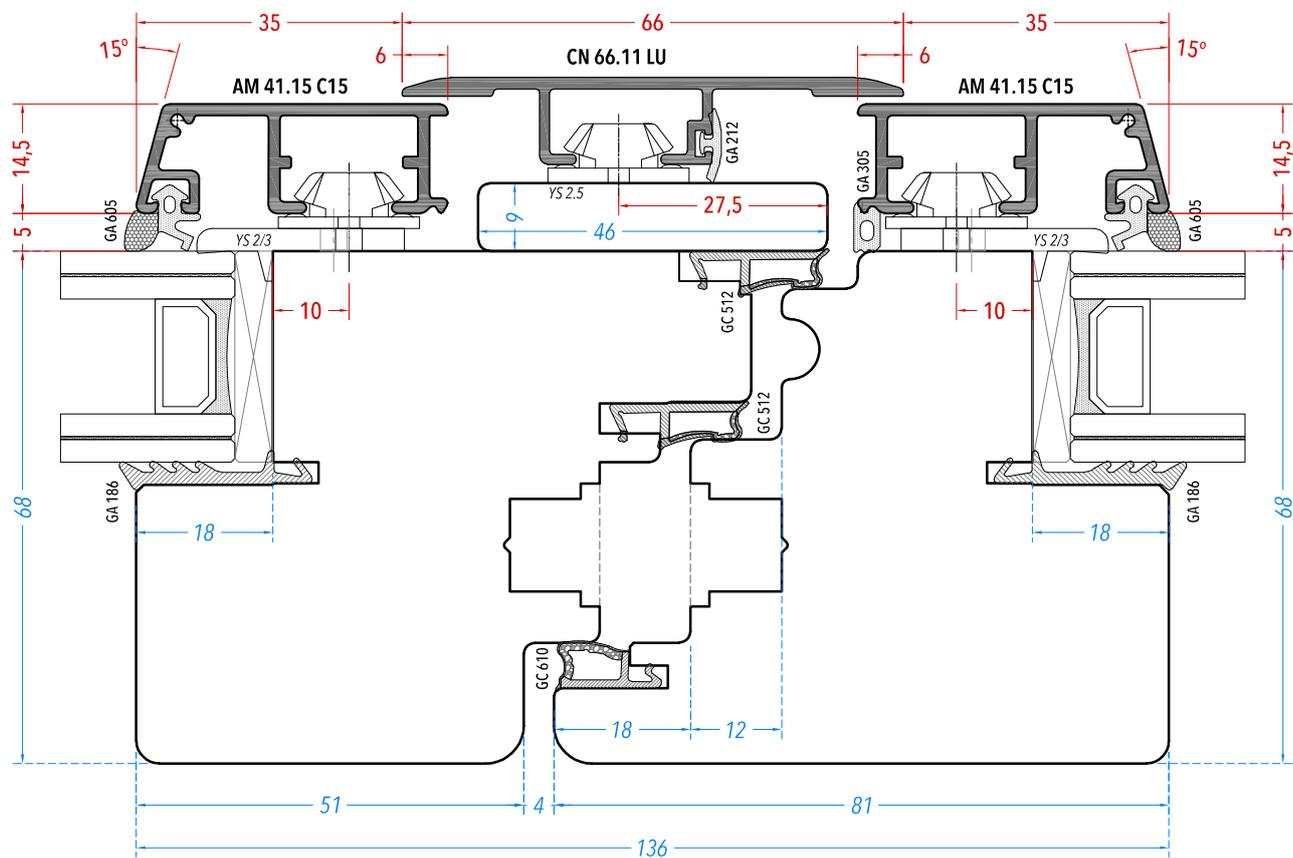
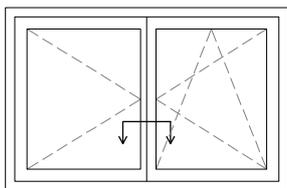

Sistema 21 - ALUMFAST SLIDE

SEZIONE ORIZZONTALE - finestra



CLIENTE:

Nodo centrale

scala 1:1 (A4)

data disegno 01/05/2020

data rev. -/-/----

Sp. telaio 65mm

Sp. anta 68mm

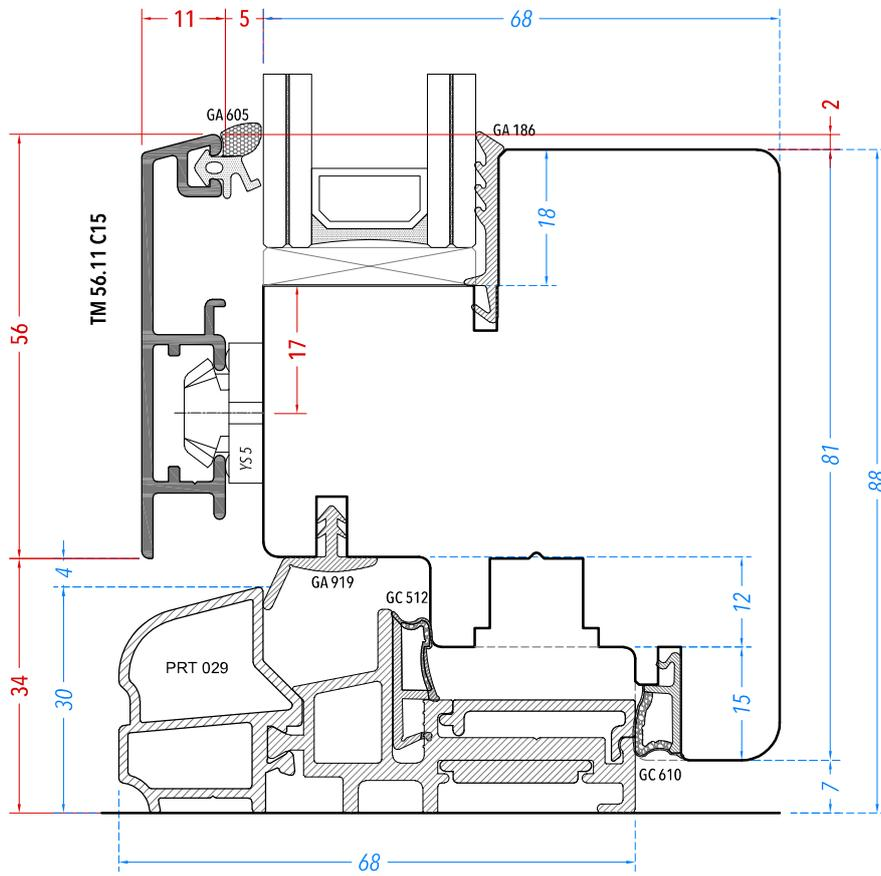
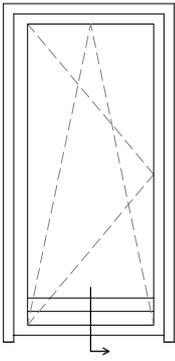

Sistema 16 - ALUMFAST

SEZIONE VERTICALE - portafinestra



CLIENTE:

Nodo inferiore

scala 1:1 (A4)

data disegno 01/05/2020

data rev. -/-/----

Sp. telaio 65mm

Sp. anta 68mm

