

# *the Barista Pro™*

SES878



EN QUICK GUIDE

DE KURZANLEITUNG

FR GUIDE RAPIDE

NL SNELSTARTGIDS

ES GUÍA RÁPIDA

# Sage®



## Contents

2	Sage® Recommends Safety First
6	Components
8	Features
9	Assembly
11	Functions
18	Care & Cleaning
22	Troubleshooting
25	Guarantee

## SAGE® RECOMMENDS SAFETY FIRST

**At Sage® we are very safety conscious. We design and manufacture appliances with your safety foremost in mind. We also ask that you exercise a degree of care when using any electrical appliance and adhere to the following precautions.**

### **READ ALL INSTRUCTIONS BEFORE USE AND SAVE FOR FUTURE REFERENCE**

- A downloadable version of this document is also available at [sageappliances.com](http://sageappliances.com)

- Before using for the first time, please ensure that your electricity supply is the same as shown on the rating label on the underside of the appliance. If you have any concerns please contact your local electricity company.
- The installation of a residual current safety switch is recommended to provide additional safety when using all electrical appliances. Safety switches with a rated operating current not more than 30mA are recommended. Consult an electrician for professional advice.
- Remove and discard any packaging materials safely, before first use.
- To eliminate a choking hazard for young children, discard the protective cover fitted to the power plug safely.
- Ensure the product is properly assembled before first use.
- This appliance is for household use only. Do not use the appliance for anything other than its intended purpose. Do not use in moving vehicles or boats. Do not use outdoors. **Misuse may cause injury.**
- Position the appliance on a stable, heat resistant, level, dry surface away from the counter edge, and do not operate on or near a heat source such as a hot plate, oven or gas hob.

- Fully unwind the power cord before operating.
- Do not let the power cord hang over the edge of a counter or table. Do not let the power cord touch hot surfaces or become knotted.
- Do not leave the appliance unattended when in use.
- If the appliance is to be:
  - left unattended
  - cleaned
  - moved
  - assembled; or
  - storedAlways switch off the espresso machine by pressing the POWER button to OFF. Switch off and unplug from the power outlet.
- Regularly inspect the power cord, plug and actual appliance for any damage. If found to be damaged in any way, immediately cease use of the appliance and return the entire appliance to the nearest authorised Sage Service Centre for examination, replacement or repair.
- Keep the appliance and accessories clean. Follow the cleaning instructions provided in this book. Any procedure not listed in this instruction booklet should be performed at an authorised Sage Service Centre.
- The appliance can be used by children aged 8 or older and persons with reduced physical, sensory or mental capabilities or a lack of experience and knowledge, only if they have been given supervision or instruction concerning use of the appliance in a safe way and understand the hazards involved.
- Children should not play with the appliance.
- Cleaning of the appliance should not be carried out by children unless they are 8 years or older and under adult supervision.
- The appliance and its cord should be kept out of reach of children aged 8 years and younger.
- Do not use attachments other than those provided with the appliances.
- Do not attempt to operate the appliance by any method other than those described in this booklet.
- Do not move the appliance whilst in operation.
- Do not use any other liquid apart from cold mains/town water. We do not recommend the use of highly filtered, de-mineralised or distilled water as this may affect the taste of the coffee and how the espresso machine is designed to function.

- Never use the appliance without water in the water tank.
- Ensure the portafilter is firmly inserted and secured into the brewing head before using the machine.
- Never remove the portafilter during the brewing operation as the machine is under pressure.
- Do not place anything, other than cups for warming, on top of the appliance.
- Use caution when operating machine as metal surfaces are liable to get hot during use.
- Do not touch hot surfaces. Allow the product to cool down before moving or cleaning any parts.
- Heating element surface is subject to residual heat after use.
- Always ensure the appliance is turned OFF, unplugged at the power outlet and has been allowed to cool before cleaning, attempting to move or storing.
- The appliance is not intended to be operated by means of an external timer or separate remote-control system.
- The use of attachments not sold or recommended by Sage may cause fire, electric shock or injury.
- Always turn the appliance to the off position, switch off at the power outlet and unplug at the power outlet when the appliance is not in use.
- Any maintenance other than cleaning should be performed by an authorised Sage® service centre.
- Do not use the appliance on a sink drain board.
- Do not operate the appliance if it is in an enclosed space, or within a cupboard.
- Use caution when descaling as hot steam may be released. Before descaling, ensure drip tray is empty and inserted. Refer to 'Care & Cleaning' for further instructions.
- Do not operate the grinder without the hopper lid in position. Keep fingers, hands, hair, clothing and utensils away from the hopper during operation.

## **SPECIFIC INSTRUCTIONS FOR WATER FILTER**

- Filter cartridge should be kept out of reach of children.
- Store filter cartridges in a dry place in the original packaging.
- Protect cartridges from heat and direct sunlight.
- Do not use damaged filter cartridges.
- Do not open filter cartridges.
- If you are absent for a prolonged period of time, empty the water tank and replace the cartridge.



The symbol shown indicates that this appliance should not be disposed of in normal household waste.

It should be taken to a local authority waste collection centre designated for this purpose or to a dealer providing this service. For more information, please contact your local council office.



To protect against electric shock, do not immerse the power cord, power plug or appliance in water or any other liquid.

**FOR HOUSEHOLD USE ONLY  
SAVE THESE INSTRUCTIONS**



## Components

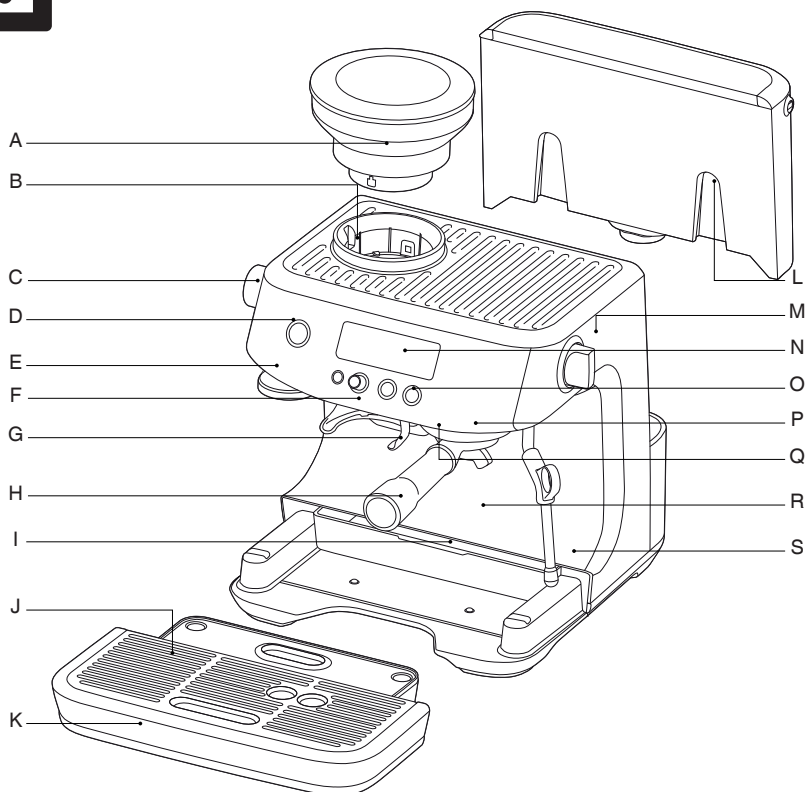

- A. 250g bean hopper  
With locking system for easy removal, storage and transfer of coffee beans.
- B. Integrated conical burr grinder
- C. Grind size selector  
30 espresso grind settings from fine to coarse.
- D. Power button
- E. Integrated removable 54mm tamper
- F. Grinder outlet
- G. Grinding cradle
- H. 54mm stainless steel portafilter  
With commercial style spouts.
- I. Storage tray (located behind drip tray)  
For storage of accessories.
- J. Removable drip tray grid
- K. Removable drip tray  
With tray full indicator.
- L. 2L removable water tank  
With replaceable water filters to reduce scale and impurities.
- M. Steam dial  
Selector control for steam and hot water.
- N. LCD display  
With grinding and extracting progress animations.
- O. Control panel  
With menu, GRIND AMOUNT/ FILTER SIZE, 1 cup and 2 cup buttons.
- P. Group head
- Q. Dedicated hot water outlet  
For making long blacks and pre-heating cups.
- R. Extra-tall cup clearance
- S. 360° swivel steam wand  
Easily adjusts to the perfect position for texturing milk.

All parts of the Barista Pro™ that come into contact with coffee, water and milk are BPA Free.

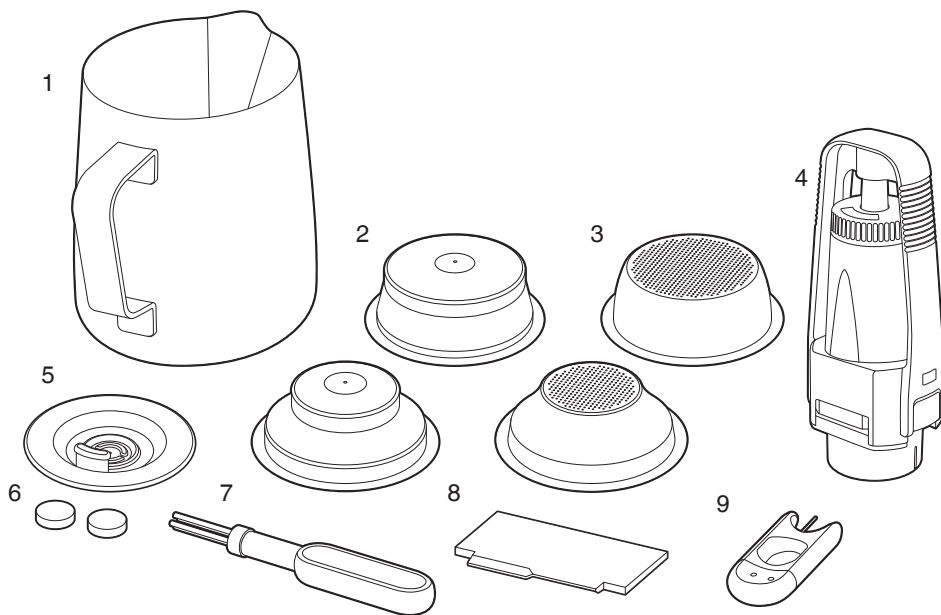

## ACCESSORIES

- |  |   |
|--|---|
| <p>1. Stainless steel milk jug<br/>With MIN and MAX markings.</p> <p>2. Dual wall filter baskets (1 cup &amp; 2 cup)<br/>Use with pre-ground coffee.</p> <p>3. Single wall filter baskets (1 cup &amp; 2 cup)<br/>Use when grinding fresh whole coffee beans.</p> <p>4. Water filter and filter holder</p> | <p>5. Cleaning disc</p> <p>6. Cleaning tablets</p> <p>7. Cleaning brush</p> <p>8. The Razor™ precision dose trimming tool</p> <p>9. Steam wand and filter basket cleaning tool</p> <p>BPA Free Materials*</p> |
|--|---|

\* Sage makes its BPA free claim for this product based on independent laboratory testing performed for all the food contact plastic materials of the product per EU Commission regulation No 10/2011.

**CE** Rating Information  
220–240V~ 50 - 60Hz 1380 - 1650W



# Barista Pro™ Features

## **THERMOJET™ HEATING SYSTEM**

Innovative heating system achieves ideal extraction temperature in 3 seconds.

## **INTEGRATED CONICAL BURR GRINDER**

Stainless steel conical burrs maximise ground coffee surface area for a full espresso flavour. Upper and lower burrs are removable for cleaning.

## **ADJUSTABLE GRIND SIZE**

30 espresso grind settings from fine to coarse for optimal extraction.

## **ADJUSTABLE GRIND AMOUNT**

Adjust the amount of fresh ground coffee dosed into the filter basket to suit the fineness or coarseness of the grind.

## **AUTOMATIC DOSING**

The grinder will dispense the required amount of ground coffee for a single or double cup dose.

## **HANDS FREE GRINDING**

Auto stop for hands free grinding directly into the portafilter.

## **THE RAZOR™ DOSE TRIMMING TOOL**

Patented twist blade trims down the puck to the right level for precision dosing and a consistent extraction.

## **ADJUSTABLE SHOT TEMPERATURE CONTROL**

For optimum coffee flavour.

## **PID TEMPERATURE CONTROL**

Electronic PID temperature control for increased temperature stability.

## **INSTANT HOT WATER**

Dedicated hot water outlet for making Long Blacks and pre-heating cups.

## **LOW PRESSURE PRE-INFUSION**

Applies low water pressure at the start of the extraction to gently expand grinds for an even extraction.

## **VOLUMETRIC CONTROL**

Pre-set 1 & 2 cup volumes, manual over-ride or programmable shot volumes.

## **DRY PUCK FEATURE**

Removes excess water from the ground coffee in the filter basket after extraction for easy disposal of the coffee puck.

## **LARGE DRIP TRAY**

With more usable workspace.





## Assembly

### BEFORE FIRST USE

#### Machine Preparation

Remove and discard all labels and packaging materials attached to your espresso machine. Ensure you have removed all parts and accessories before discarding the packaging. Remove the packaging and the plastics bags containing the water filter and water filter holder.

Clean the water tank, portafilter, filter baskets, milk jug and drip tray using warm water and a gentle dish washing liquid. Rinse well, then dry thoroughly before reassembling.

#### INSTALLING THE WATER FILTER

- Remove the water filter and water filter holder from the packaging.
- Set the reminder for the next month of replacement. We recommend to replace the filter after 3 months.
- Soak the filter in cold water for 5 minutes.
- Wash the filter holder with cold water.
- Insert the filter into the two parts of the filter holder. Ensure they are connected.
- Remove the water tank from the machine. Align the base of the filter holder with the adapter inside the water tank. Push down to lock into place.
- Fill the water tank with cold potable water and reattached the machine, ensuring it is properly attached and sitting flush to the back of the machine.
- Refer to 'Care & Cleaning' on page 18 for further instructions.



#### NOTE

DO NOT use highly filtered, demineralised or distilled water in this machine. This may affect the taste of the coffee.



#### NOTE

For replacement water filters, visit the Sage webpage or contact Sage Customer Service.

#### FILLING THE WATER TANK

- Ensure the water filter is securely fitted inside the water tank.
- Use the handle at the top of the water tank to assist in lifting it up and away from the machine.

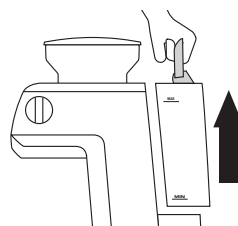

- Fill the water tank with cold potable tap water to below the MAX marking indicated on the side of the water tank.
- Replace the water tank back on the machine, pressing down to ensure that it is properly positioned and attached to the machine.

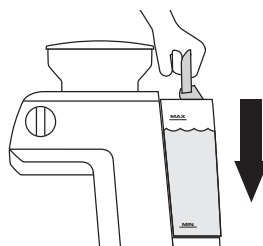

#### NOTE

Replace the water daily. The water tank should be filled with fresh, cold tap water before each use.



## Assembly

### ATTACHING THE HOPPER

Insert the bean hopper into position on top of the machine.

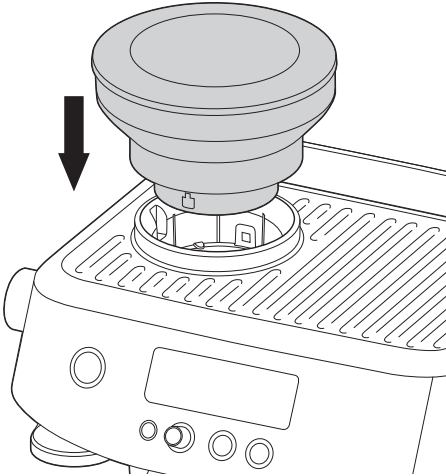

Turn the dial to lock the hopper into place. Fill with fresh coffee beans.



### FIRST USE CYCLE

A first use cycle must be completed before the initial use of the machine. The first use cycle rinses the machine and primes the heating system.

1. Fill the water tank.
2. Ensure machine is fully assembled with the bean hopper, drip tray and water tank securely attached to the machine.
3. Press the POWER button. The machine will beep and go into FIRST CYCLE mode.
4. The LCD will display FLUSH and the 1 CUP button will be illuminated.

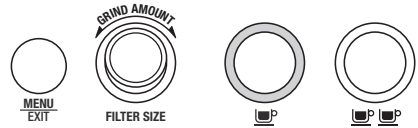
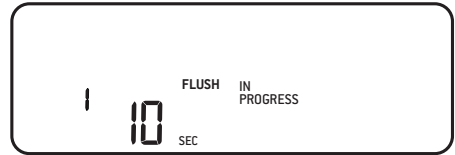

5. Press the 1 CUP button. The LCD will show a count down for the remaining time of the first use cycle.
6. Once complete, the machine will go into READY mode.



## Functions

### TURNING OFF THE MACHINE

To turn the machine off, press the POWER button. Alternatively, the machine has auto-off, if it is not used for 30 minutes.

### FILTER BASKETS

This machine includes 4 filter baskets; 2 x Single Wall and 2 x Dual Wall.

Single Wall filter baskets should be used when grinding fresh whole coffee beans. They allow you to experiment with grind, dose and tamp to create a more balanced espresso.

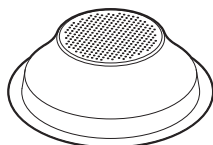

**1 CUP**

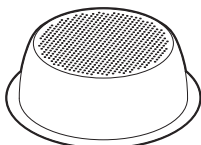

**2 CUP**

Dual Wall filter baskets should be used when using pre-ground coffee. They regulate the pressure and help to optimise the extraction regardless of the grind, dose and tamp pressure or freshness.

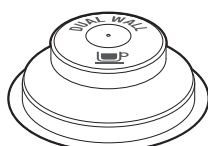

**1 CUP**



**2 CUP**

Regardless of whether you use Single Wall or Dual Wall filters baskets, use the 1 CUP basket when brewing a single cup and the 2 CUP basket when brewing two cups or a stronger single cup or mug.

You will need to adjust the grind amount and size if switching from a single to a double basket, or vice versa.

The provided filter baskets are designed for:

1 CUP basket = approx. 8 – 10g

2 CUP basket = approx. 19 – 22g



### NOTE

You may need to experiment with how much coffee is dosed into the filter basket or how long the grinder needs to run to achieve the correct dose. For example; when using a finer espresso grind with the Single Wall filter baskets, you may need to increase the grind amount to ensure the filter basket is correctly dosed.

## THE GRIND

When grinding coffee beans, the grind size should be fine, but not too fine. The grind size will affect the rate at which water flows through the ground coffee in the filter basket and the taste of the espresso.

If the grind is too fine (looks like powder and feels like flour when rubbed between the fingers), the water will not flow through the coffee, even when under pressure. The resulting espresso will be **OVER EXTRACTED**, dark in colour and bitter in flavour.

If the grind is too coarse, the water will flow through the ground coffee in the filter basket too quickly. The resulting espresso will be **UNDER EXTRACTED** and lacking in colour and flavour.

## SETTING THE GRIND SIZE

This machine has 30 grind settings to select from, with the size selected displayed on the LCD screen. The default grind size is 15.

When adjusting the grind size, a bar will display on the LCD indicating a faster or slower pour.

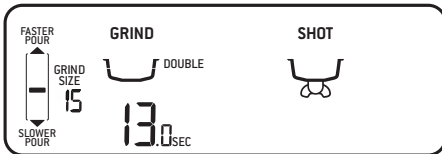

Use the GRIND SIZE selector on the left side of the machine to adjust the grind size.

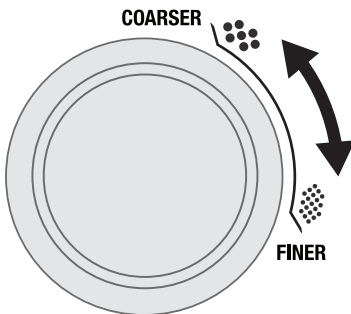

## DOSING THE COFFEE

- Fill the hopper with fresh coffee beans.
- Insert the required filter basket into the portafilter.
- Place the portafilter into the grinding cradle.
- If required, press the FILTER SIZE button to select the filter basket size; Single or Double.
- If required, turn the GRIND AMOUNT dial to change the grind time; clockwise to increase the time and anti-clockwise to decrease.



### NOTE

The default grind times are 9.5 seconds for a 1 cup filter and 13 seconds for a 2 cup filter.

- Press and release the portafilter to activate the automatic dosing. The LCD will show the filter basket filling.

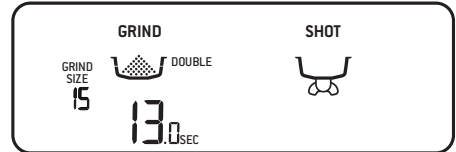

- If you need to pause the grinding function, press and release the portafilter. The LCD will show **PAUSED**, it will remain paused for 10 seconds before returning to **READY** mode.
- Press and release the portafilter to resume grinding.



### NOTE

It is normal for the portafilter to appear overfilled with ground coffee.

## MANUAL DOSING

To manually dose the coffee, press and hold the portafilter in the grinding cradle until the desired amount of ground coffee has been dosed. To stop grinding, release the portafilter.

The timer will count up, displaying the grind time.

## TAMPING THE GROUND COFFEE

- Remove the portafilter from the grinding cradle.
- Tap the portafilter several times to collapse and distribute the coffee evenly in the filter basket.
- Using the tamper, tamp down firmly (approx. 15–20kg of pressure). The amount of pressure is not as important as the consistent pressure every time.

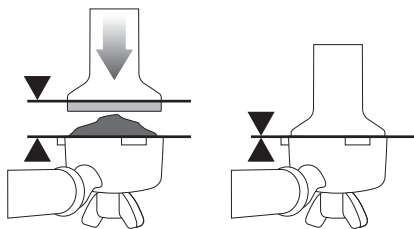

- As a guide, the top edge of the cap on the tamper should be level with the top of the filter basket AFTER the coffee has been tamped.

### NOTE

We recommend quality 100% Arabica beans with a 'Roasted On' date stamped on the bags, not a 'Best Before' or 'Use By' date. Coffee beans are best consumed between 5 – 20 days after the 'Roasted On' date. Stale coffee may pour too quickly from the portafilter and taste bitter and watery.

## TRIMMING THE DOSE

The Razor™ precision dose trimming tool allows you to trim the puck to the right level for a consistent extraction.

- Insert the Razor™ dose trimming tool into the filter basket until the shoulders of the tool rest on the rim of the basket. The blade of the dose trimming tool should penetrate the surface of the tamped coffee.
- Rotate the Razor™ dose trimming tool back and forth while holding the portafilter on an angle over a knock box to trim off excess coffee grinds. Your filter basket is now dosed with the correct amount of coffee.

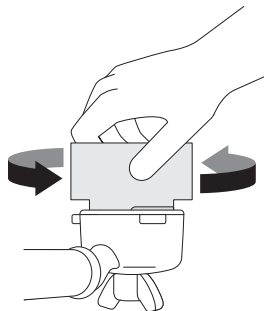

- Wipe excess coffee from the rim of the filter basket to ensure a proper seal is achieved in the group head.

## PURGING THE GROUP HEAD

Before placing the portafilter into the group head, run a short flow of water through the group head by pressing the 1 CUP button. This will stabilise the temperature prior to extraction and preheat the portafilter for a consistent shot temperature.





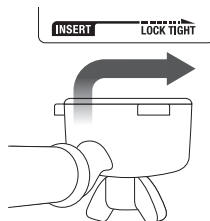



## INSERTING THE PORTAFILTER

- Place the portafilter underneath the group head so that the handle is aligned with the INSERT position. Insert the portafilter into the group head and rotate the handle towards the centre until firm resistance is felt.

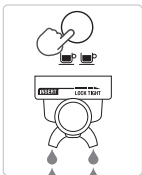

## EXTRACTING ESPRESSO

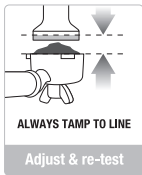
- As a guide the espresso will start to flow after 8–10 seconds (infusion time) and should be the consistency of dripping honey.
- If the espresso starts to flow after less than 6 seconds, you have either under dosed the filter basket and /or the grind is too coarse. This is an **UNDER EXTRACTED** shot.
- If the espresso starts to drip but doesn't flow after 15 seconds, the grind is too fine. This is an **OVER EXTRACTED** shot.

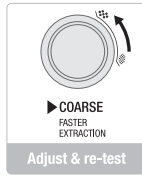
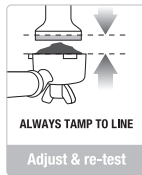
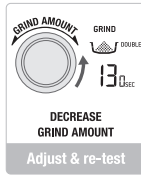
CORRECT EXTRACTION	UNDER EXTRACTION	OVER EXTRACTION	
			
<ul style="list-style-type: none"> <li>• Flow starts after 8-12 secs</li> <li>• Flow slow like warm honey</li> <li>• Crema is golden brown with a fine mousse texture</li> <li>• Espresso is dark brown</li> </ul>	<ul style="list-style-type: none"> <li>• Flow starts after 1-7 secs</li> <li>• Flow fast like water</li> <li>• Crema is thin and pale</li> <li>• Espresso is pale brown</li> <li>• Tastes bitter/sharp, weak and watery</li> </ul>	<ul style="list-style-type: none"> <li>• Flow starts after 13 secs</li> <li>• Flow drips or not at all</li> <li>• Crema is dark and spotty</li> <li>• Espresso is very dark brown</li> <li>• Tastes bitter and burnt</li> </ul>	
<p><b>AFTER EXTRACTION</b></p> <div data-bbox="98 831 239 1007">  <p><b>REMOVE USED GRINDS</b> Used grinds will form a coffee 'puck'. If the puck is wet, refer to the 'Under Extraction' section.</p> </div> <div data-bbox="98 1015 239 1190">  <p><b>RINSE FILTER BASKET</b> Keep the filter basket clean to prevent blockages. Without ground coffee in the filter basket, lock the portafilter into the machine and run hot water through.</p> </div>	<p><b>SOLUTIONS</b></p> <div data-bbox="412 831 553 1007">  <p><b>FINE</b> SLOWER EXTRACTION Adjust &amp; re-test</p> </div> <div data-bbox="412 1015 553 1190">  <p><b>ALWAYS TAMP TO LINE</b> Adjust &amp; re-test</p> </div> <div data-bbox="561 831 702 1007">  <p><b>GRIND AMOUNT</b> GRIND DOUBLE 13 SEC <b>INCREASE GRIND AMOUNT</b> Adjust &amp; re-test</p> </div> <div data-bbox="561 1015 702 1190"> <p>Tamp using 15-20kgs of pressure. The top edge of metal cap on the tamper should be level with the top of the filter basket AFTER tamping. Trim the puck to the right level using the Razor™ precision dose trimming tool.</p> </div>	<p><b>SOLUTIONS</b></p> <div data-bbox="725 831 866 1007">  <p><b>COARSE</b> FASTER EXTRACTION Adjust &amp; re-test</p> </div> <div data-bbox="725 1015 866 1190">  <p><b>ALWAYS TAMP TO LINE</b> Adjust &amp; re-test</p> </div> <div data-bbox="874 831 1015 1007">  <p><b>GRIND AMOUNT</b> GRIND DOUBLE 13 SEC <b>DECREASE GRIND AMOUNT</b> Adjust &amp; re-test</p> </div> <div data-bbox="874 1015 1015 1190"> <p>Tamp using 15-20kgs of pressure. The top edge of metal cap on the tamper should be level with the top of the filter basket AFTER tamping. Trim the puck to the right level using the Razor™ precision dose trimming tool.</p> </div>	
<p><b>OVER EXTRACTED</b> BITTER • ASTRINGENT</p>	<p><b>GRIND</b> Too fine</p>	<p><b>GRIND DOSE</b> Too much Use razor to trim</p>	<p><b>TAMP</b> Too heavy</p>
<p><b>BALANCED</b></p>	<p>Optimum</p>	<p>8–10g (1 cup) 19–22g (2 cup)</p>	<p>15–20kg</p>
<p><b>UNDER EXTRACTED</b> UNDERDEVELOPED • SOUR</p>	<p>Too coarse</p>	<p>Too little Increase dose &amp; use razor to trim</p>	<p>Too light</p>

## PRE-PROGRAMMED SHOT VOLUME – 1 CUP

- Press the 1 CUP button once, the button will flash, indicating that it has been selected. The LCD will display PRE-INFUSE and the shot clock will start counting up. Once pre-infusion is complete, the shot will start extracting. A pre-set single espresso volume of approx. 30ml will be extracted. The machine will automatically stop once the pre-set volume has been extracted.

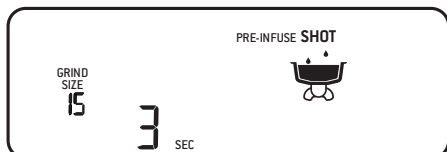

## PRE-PROGRAMMED SHOT VOLUME – 2 CUP

- Press the 2 CUP button once, the button will flash, indicating that it has been selected and the LCD will display PRE-INFUSE and the shot clock will start counting up. Once pre-infusion is complete, the shot will start extracting. A pre-set double espresso volume of approx. 60ml will be extracted. The machine will automatically stop once the pre-set volume has been extracted.



## MANUAL PRE-INFUSION & EXTRACTION

- Press and hold the 1 CUP or 2 CUP button for the desired pre-infusion time. Release the button to commence the extraction. Press the flashing button to stop the extraction.



## PROGRAMMING ESPRESSO SHOT

- Press the MENU button to enter the main menu.

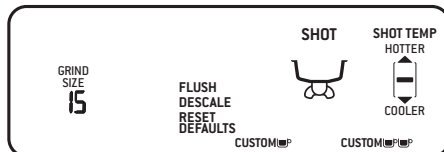

- Use the GRIND AMOUNT dial to navigate through the menu to the custom ☺☺ or custom ☺☺☺. To select, press the dial.
- Press the desired CUP button to start the default pre-infusion. To customise the pre-infusion, press and hold the same CUP button for the desired pre-infusion time. Release the button to commence the extraction.
- To stop the extraction at the desired level, press the CUP button. The LCD and CUP button will stop flashing and the machine will beep to indicate that the custom setting has been remembered. The machine will then return to READY mode. The custom setting can now be activated by pressing the desired CUP button selected.

## ADJUSTING SHOT TEMPERATURE

- Press the MENU button to enter the main menu.
- Use the GRIND AMOUNT dial to navigate the menu and press to select SHOT TEMP.

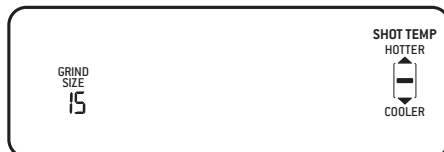

- Use the GRIND AMOUNT dial to increase or decrease the shot temperature as displayed on the LCD.
- Press the dial to confirm the desired temperature. The machine will return to READY mode.

## RESETTING TO DEFAULTS

- Press the MENU button to enter the main menu.
- Use the GRIND AMOUNT dial to navigate the menu and select RESET DEFAULTS.
- The GRIND AMOUNT, FILTER SIZE, SHOT TEMP, 1 CUP and 2 CUP SHOT settings will all return to the default settings. The machine will return to READY mode.

## USING HOT WATER OUTLET

The hot water function can be used to pre-heat cups or to add hot water manually.

To activate the hot water, turn the STEAM dial to .

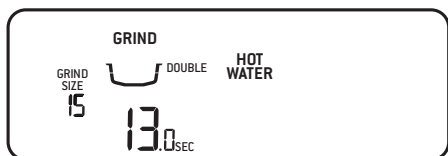

- The LCD will show that HOT WATER has been activated.
- To stop the hot water, turn the dial back to the centre, vertical position.
- The hot water will stop after 60 seconds, but the dial must be turned back manually to the standby position.

## TEXTURING MILK

It is recommended to momentarily purge the steam wand prior to texturing milk.

Position the steam wand over the drip tray and turn the STEAM dial to the . The LCD will display STEAM when activated. Turn the STEAM dial back to a vertical position to stop steaming.

Different brands and types of milk and milk alternatives will texture differently.

- Start with fresh cold milk.
- Fill the milk jug to between the MIN and MAX markings.
- Lift the steam wand and insert into the milk jug with the steam wand tip 1–2cm below the surface of the milk, close to the right-hand side of the jug at a 3 o'clock position.
- Turn the STEAM dial to the .
- Keep the steam wand tip just under the surface of the milk until the milk is spinning clockwise, producing a vortex (whirlpool effect).
- With the milk spinning, slowly lower the jug. This will bring the steam wand tip to the surface of the milk and start to introduce air into the milk.
- Gently break the surface of the milk with the tip to get the milk spinning fast enough.
- Keep the steam wand tip at or slightly below the surface, continuing to maintain the vortex. Texture the milk until sufficient volume is obtained.

- Lift the jug to lower the tip beneath the surface but keep the vortex spinning. The milk is at the correct temperature (60–65°C) when the jug is hot to touch.



- Once the desired temperature has been achieved, turn the STEAM dial back to the vertical position.
- Remove the steam wand from the milk jug.
- Wipe the steam wand with a clean, damp cloth. Then return to lowered position over the drip tray.



### CAUTION: BURN HAZARD

Pressurised steam can still be released, even after machine has been switched off. Children must always be supervised.



### NOTE

Ensure the STEAM dial is in the vertical position before removing the steam wand from the milk jug.



### NOTE

When the machine creates steam, a pumping noise can be heard. This is normal operation.



### NOTE

Use only the supplied stainless steel milk jug to froth milk using this machine. The use of other containers may lead to dangerous conditions.

## STEAM WAND PURGING

After texturing milk, it is recommended to purge the steam wand. With the steam wand positioned over the drip tray and turn the STEAM dial to the , and allow the machine to purge. Turn the STEAM dial back to a vertical position to stop steaming.



## ADJUSTING CONICAL BURRS

Some types of coffee may require a wider grind range to achieve an ideal extraction or brew. A feature of your Barista Pro™ is the ability to extend this range with an adjustable upper burr. We recommend making only one adjustment at a time.

- 

1  
TURN TO LOCK

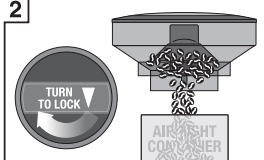
Unlock hopper
- 

2  
TURN TO LOCK

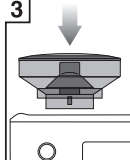
Hold hopper over container & turn dial to release beans into container
- 

3

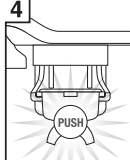
Align hopper into position
- 

4  
PUSH

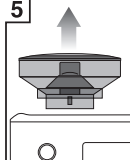
Run grinder until empty
- 

5

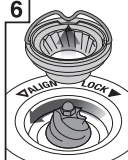
Remove hopper
- 

6  
ALIGN LOCK

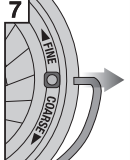
Remove upper burr
- 

7  
FINE COARSE

Remove wire handle from both sides of the burr
- 

8  
FINE COARSE

Move adjustable top burr, 1 number coarser or finer
- 

9  
FINE COARSE

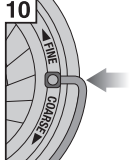
Align the number with the handle opening
- 

10  
FINE COARSE

Insert wire handle from both sides of the burr
- 

11  
ALIGN LOCK

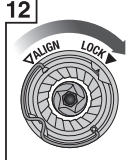
Push upper burr firmly into position
- 

12  
ALIGN LOCK

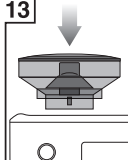
Lock upper burr
- 

13

Align hopper into position
- 

14  
TURN TO LOCK

Lock hopper
- 

15

Check your extraction



## Care & Cleaning

### INSTALLING THE WATER FILTER

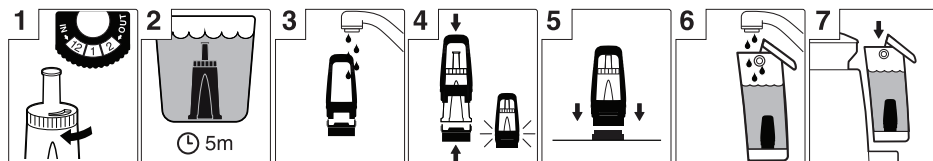

1. Remove the water filter and water filter holder from the packaging. Set the reminder for the next month of replacement. We recommend to replace the filter after 3 months.
2. Soak the filter in cold water for 5 minutes.
3. Wash the filter holder with cold water.
4. Insert the filter into the two parts of the filter holder. Ensure they are connected.
5. Remove the water tank from the machine. Align the base of the filter holder with the adapter inside the water tank. Push down to lock into place.
6. Remove the water tank from the machine. Align the base of the filter holder with the adapter inside the water tank. Push down to lock into place.
7. Fill the water tank with cold potable water and reattached the machine, ensuring it is properly attached and sitting flush to the back of the machine.



#### NOTE

Replacement water filters can be purchased from the Sage website or by contacting Sage Customer Service.

### FLUSH CLEANING CYCLE

The LCD will display a FLUSH alert when a cleaning cycle is required. The cleaning cycle is separate from descaling.

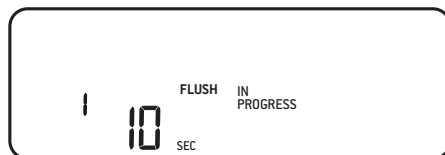

1. Insert the cleaning disc into the filter basket in the portafilter.
2. Place a cleaning tablet on top of the cleaning disc.
3. Lock the portafilter into the group head.
4. Empty the drip tray and replace onto the machine.
5. Fill the water tank to the MAX line then reattach to the machine.
6. Press the MENU button to enter the main menu.
7. Use the GRIND AMOUNT dial to navigate the menu to FLUSH, then press to select. The 1 CUP button will illuminate.
8. Press the 1 CUP button to start the cleaning cycle. The remaining time for the cleaning cycle will be displayed on the LCD.
9. Once the cleaning cycle is complete, the machine will beep and return to READY mode. If any of the cleaning tablet remains in the cleaning disc, repeat the cycle.
10. Empty and rinse the portafilter, cleaning disc and drip tray.

## DESCALING

After regular use, hard water can cause mineral build up in and on many of the inner functioning components, reducing the brewing flow, brewing temperature, power of the machine, and the taste of the espresso. The LCD will display a DESCALE alert, when a descaling cycle is required.

1. Empty the drip tray and reattach to the machine. Remove the water tank from the machine and remove the filter from the water tank.
2. Fill the water tank to the DESCALE line indicated and add the descaling agent to the water. Reattach the water tank to the machine.
3. Press the MENU button to enter the main menu. Use the GRIND AMOUNT dial to navigate the menu to DESCALE, then press to select. The 1 CUP button will illuminate.
4. Press the 1 CUP button to start the descaling cycle. The descale cycle cleans in 3 stages; coffee, hot water and steam. After each stage is complete, the machine will beep. The STEAM DIAL must be manually turned to the HOT WATER and STEAM position when indicated on the LCD.

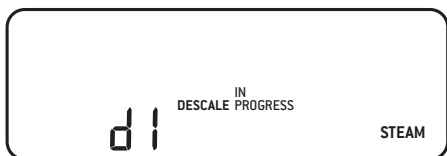

5. Once the descale cycle is complete, the machine needs to complete a rinse cycle. The 1 CUP button will illuminate. As with the descale cycle, the STEAM DIAL must be manually turned to correct position when indicated on the LCD.
6. Remove and empty the drip tray then replace onto the machine. Empty any remaining descaling liquid from the water tank, then fill the water tank to the MAX line and reattached to the machine.
7. Press the 1 CUP button to commence the rinse cycle. The rinse cycle is also 3 stages. The LCD will show which stage it is up to. After each stage, the machine will beep.
8. Once the rinse cycle is complete, the machine will beep and return to READY mode.
9. Remove and rinse the drip tray and water tank. Dry thoroughly before replacing them on the machine.

## CLEANING THE CONICAL BURR GRINDER

This grinder cleaning cycle removes oil build-up on the burrs which can impede performance.

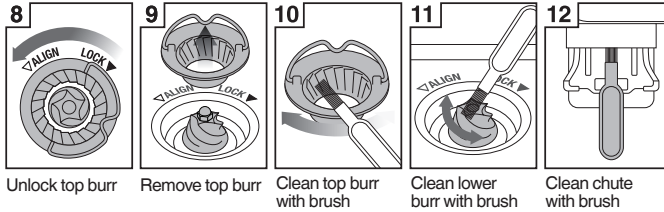
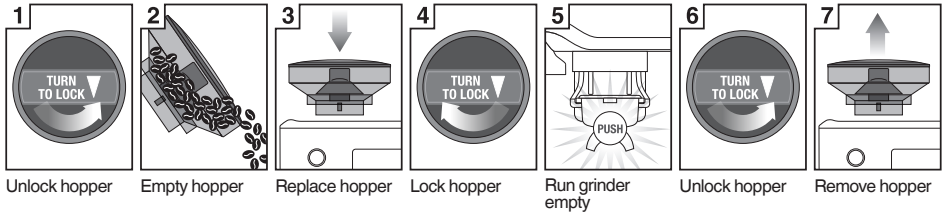

## ADVANCED CLEANING FOR THE CONICAL BURR GRINDER

This step is only required if there is a blockage between the grinding burrs and the grinder outlet.

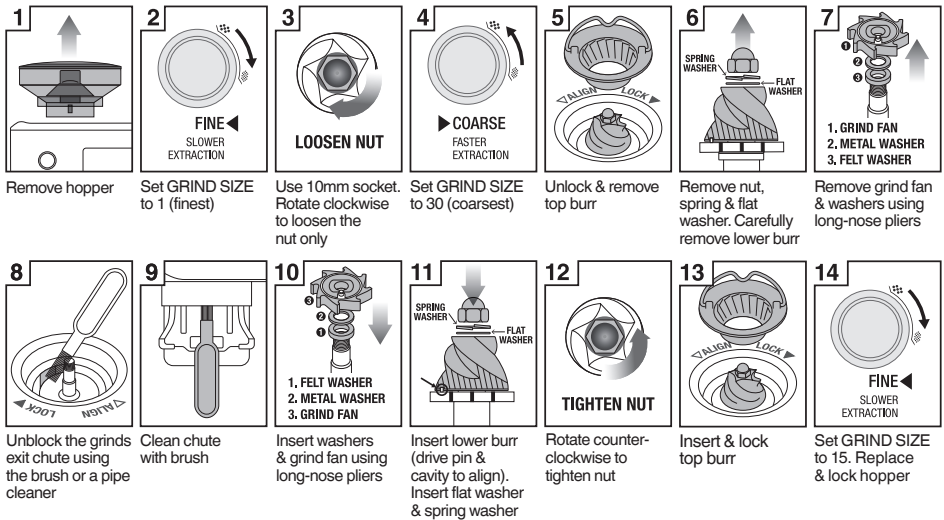

Care should be taken as the grinder burrs are extremely sharp.

## CLEANING THE STEAM WAND

- The steam wand should always be cleaned after texturing milk. Wipe the steam wand with a damp cloth.
- After use, it is recommended to purge the steam wand for a couple of seconds, to clear any remaining milk. With the steam wand positioned down over the drip tray, turn the STEAM dial to  for a couple of seconds allow the machine to create steam for a couple of seconds before turning it back to the vertical position.
- If the steam tip hole becomes blocked, it will reduce frothing performance. Use the provided steam wand cleaning tool to clear the opening.
- If the steam wand is still blocked, use the spanner in the middle of the steam wand cleaning tool to unscrew the tip. Soak the tip in hot water before using the cleaning tool to unblock again. Replace the tip back on the steam wand, using the tool.

## CLEANING THE FILTER BASKETS AND PORTAFILTER

- The filter baskets and portafilter should be rinsed under hot water immediately after use to remove all residual coffee oils.
- If any of the holes in the filter basket become blocked, use the pin on the end of the provided cleaning tool to unblock the holes.
- If the holes remain blocked, dissolve a cleaning tablet in hot water and soak filter basket and portafilter in solution for approx. 20 minutes. Rinse thoroughly.

## CLEANING THE GROUP HEAD

- The group head interior and shower screen should be wiped with a damp cloth after use to remove any ground coffee particles.
- Periodically purge the machine. Place an empty filter basket and portafilter into the group head. Press the 1 CUP button and run a short flow of water to rinse out any residual coffee. Press the 1 CUP button again to stop the hot water. Remove the portafilter and rinse thoroughly.

## CLEANING THE DRIP TRAY

1. The drip tray should be removed, emptied and cleaned at regular intervals, particularly when the drip tray full indicator is showing EMPTY ME!

2. Remove the drip tray from the machine and separate the parts. The EMPTY ME! indicator can also be removed from the drip tray by pulling upwards to release the side latches. Wash all parts in warm soapy water with a soft cloth. Rinse and dry thoroughly before reassembling and attaching to the machine.
3. The storage tray (located behind the drip tray) can be removed and cleaned with a soft, damp cloth.



### NOTE

All parts should be cleaned by hand using warm water and a gentle dish washing liquid. Do not use abrasive cleansers, pads or cloths which can scratch the surface. Do not clean any of the parts or accessories in the dishwasher.



### WARNING

Do not immerse the power cord, power plug or appliance in water or any other liquid.

## CLEANING THE OUTER HOUSING

Wipe the outer housing with a soft, damp cloth and then polish with a soft, dry cloth.

## STORING YOUR MACHINE

Before storing, press the POWER button to turn the machine off then turn off and remove the plug from the power outlet. Remove unused beans from the hopper, clean the grinder (see page 18), empty the water tank and the drip tray. Ensure the machine is cool, clean and dry. Place accessories in the storage tray.

Store the machine upright and do not store anything on top.

## ERROR MODE

If your machine displays  $E_r$  on the LCD, contact Sage Customer Service.



# Troubleshooting

<b>PROBLEM</b>	<b>POSSIBLE CAUSES</b>	<b>WHAT TO DO</b>
<b>Water does not flow from the group head. No hot water.</b>	• Water tank is empty.	• Fill tank.
	• Water tank is not fully inserted and locked into position.	• Push water tank down completely to lock into place.
	• Machine needs to be descaled.	• Perform descale cycle.
<b>Espresso only drips from the portafilter spouts or not at all.</b>	• Coffee is ground too finely and/or too much coffee in filter basket and/or over tamping and/or filter basket is blocked.	• See below, 'Espresso only drips from the portafilter spouts or not at all'.
	• Coffee is ground too finely.	• Use slightly coarser grind. Refer to 'Setting the Grind Size', page 12 and 'Over Extraction', page 14.
<b>Espresso only drips from the portafilter spouts or not at all.</b>	• Too much coffee in the filter basket.	• Lower dose of coffee. Refer to 'Dosing', page 12 and 'Over Extraction', page 14. • After tamping, trim the coffee dose using the Razor™ dose trimming tool.
	• Coffee tamped too firmly.	• Tamp between or 15–20kg of pressure.
	• Water tank is empty.	• Fill tank.
	• Water tank is not fully inserted and locked into position.	• Push water tank down completely to lock into place.
	• The filter basket may be blocked.	• Use the pin on the end of the provided cleaning tool to unblock the hole(s). • If the hole(s) remain blocked, dissolve a cleaning tablet in hot water and soak filter basket and portafilter in solution for approx. 20 minutes. Rinse thoroughly.
<b>Water doesn't come through (the machine makes loud noise).</b>	• Machine needs to be descaled.	• Perform descale cycle.
	• Water tank is empty or water level is below MIN.	• Fill tank.

<b>PROBLEM</b>	<b>POSSIBLE CAUSES</b>	<b>WHAT TO DO</b>
<b>Espresso runs out too quickly.</b>	<ul style="list-style-type: none"> <li>Coffee is ground too coarsely.</li> </ul>	<ul style="list-style-type: none"> <li>Use slightly finer grind. Refer to 'Setting the Grind Size', page 12 and 'Under Extraction', page 14.</li> </ul>
	<ul style="list-style-type: none"> <li>Not enough coffee in the filter basket.</li> </ul>	<ul style="list-style-type: none"> <li>Increase dose of coffee. Refer to 'Dosing', page 12 and 'Under Extraction', page 14. Tamp then use the Razor™ dose trimming tool to trim off excess coffee.</li> </ul>
	<ul style="list-style-type: none"> <li>Coffee tamped too lightly.</li> </ul>	<ul style="list-style-type: none"> <li>Tamp between or 15–20kg of pressure.</li> </ul>
<b>Espresso runs out around the edge of the portafilter.</b>	<ul style="list-style-type: none"> <li>Portafilter not inserted in the group head correctly.</li> </ul>	<ul style="list-style-type: none"> <li>Ensure portafilter is completely inserted and rotated until resistance is felt.</li> </ul>
	<ul style="list-style-type: none"> <li>There are coffee grounds around the filter basket rim.</li> </ul>	<ul style="list-style-type: none"> <li>Clean excess coffee from the rim of the filter basket to ensure a proper seal in group head.</li> </ul>
	<ul style="list-style-type: none"> <li>Too much coffee in the filter basket.</li> </ul>	<ul style="list-style-type: none"> <li>Lower dose of coffee. Refer to 'Dosing', page 12.</li> <li>After tamping, trim the coffee dose using the Razor™ dose trimming tool.</li> </ul>
<b>No steam.</b>	<ul style="list-style-type: none"> <li>Machine has not reached operating temperature.</li> </ul>	<ul style="list-style-type: none"> <li>Allow time for the machine to reach operating temperature.</li> </ul>
	<ul style="list-style-type: none"> <li>Water tank is empty.</li> </ul>	<ul style="list-style-type: none"> <li>Fill tank.</li> </ul>
	<ul style="list-style-type: none"> <li>Water tank is not fully inserted and locked into position.</li> </ul>	<ul style="list-style-type: none"> <li>Push water tank down completely to lock into place.</li> </ul>
	<ul style="list-style-type: none"> <li>Machine needs to be descaled.</li> </ul>	<ul style="list-style-type: none"> <li>Perform descale cycle.</li> </ul>
	<ul style="list-style-type: none"> <li>Steam wand is blocked.</li> </ul>	<ul style="list-style-type: none"> <li>Refer to 'Cleaning the Steam Wand', page 21.</li> </ul>
<b>Pulsing/pumping sound while extracting espresso or steaming milk.</b>	<ul style="list-style-type: none"> <li>The machine is carrying out the normal operation of the pump.</li> </ul>	<ul style="list-style-type: none"> <li>No action required as this is the normal operation of the machine.</li> </ul>
	<ul style="list-style-type: none"> <li>Water tank is empty.</li> </ul>	<ul style="list-style-type: none"> <li>Fill tank.</li> </ul>
	<ul style="list-style-type: none"> <li>Water tank is not fully inserted and locked into position.</li> </ul>	<ul style="list-style-type: none"> <li>Push water tank down completely to lock into place.</li> </ul>

<b>PROBLEM</b>	<b>POSSIBLE CAUSES</b>	<b>WHAT TO DO</b>	
<b>Coffee not hot enough.</b>	<ul style="list-style-type: none"> <li>• Cups not pre-heated.</li> </ul>	<ul style="list-style-type: none"> <li>• Rinse cups under hot water outlet.</li> </ul>	
	<ul style="list-style-type: none"> <li>• Portafilter not pre-heated.</li> </ul>	<ul style="list-style-type: none"> <li>• Rinse portafilter under hot water outlet. Dry thoroughly.</li> </ul>	
	<ul style="list-style-type: none"> <li>• Milk not hot enough (if making a cappuccino or latté etc).</li> </ul>	<ul style="list-style-type: none"> <li>• Texture milk for a longer period of time.</li> </ul>	
	<ul style="list-style-type: none"> <li>• Water temperature needs to be adjusted.</li> </ul>	<ul style="list-style-type: none"> <li>• Increase the brew temperature refer to 'Adjusting Shot Temperature' page 15.</li> </ul>	
<b>No crema.</b>	<ul style="list-style-type: none"> <li>• Coffee tamped too lightly.</li> </ul>	<ul style="list-style-type: none"> <li>• Tamp between 15–20kg of pressure.</li> </ul>	
	<ul style="list-style-type: none"> <li>• Coffee is ground too coarsely.</li> </ul>	<ul style="list-style-type: none"> <li>• Use slightly finer grind. Refer to 'Setting the Grind Size', page 12 and 'Under Extraction', page 14.</li> </ul>	
	<ul style="list-style-type: none"> <li>• Coffee beans or pre-ground coffee are not fresh.</li> </ul>	<ul style="list-style-type: none"> <li>• If grinding fresh whole coffee beans, use freshly roasted coffee beans with a 'Roasted On' date and consume between 5–20 days after that date.</li> <li>• If using pre-ground coffee, use within a week of grinding.</li> </ul>	
	<ul style="list-style-type: none"> <li>• The filter basket may be blocked.</li> </ul>	<ul style="list-style-type: none"> <li>• Use the pin on the end of the provided cleaning tool to unblock the hole(s).</li> <li>• If the hole(s) remain blocked, dissolve a cleaning tablet in hot water and soak filter basket and portafilter in solution for approx. 20 minutes. Rinse thoroughly.</li> </ul>	
	<ul style="list-style-type: none"> <li>• Single Wall filter baskets are being used with pre-ground coffee.</li> </ul>	<ul style="list-style-type: none"> <li>• Ensure you use Dual Wall filter baskets with pre-ground coffee.</li> </ul>	
	<b>Water leaking.</b>	<ul style="list-style-type: none"> <li>• Water tank is not fully inserted and locked into position.</li> </ul>	<ul style="list-style-type: none"> <li>• Push water tank down completely to lock into place.</li> </ul>
	<b>Machine is on but ceases to operate.</b>	<ul style="list-style-type: none"> <li>• The safety thermal-cut out may have activated due to the pump or grinder overheating.</li> </ul>	<ul style="list-style-type: none"> <li>• Press the POWER button to switch the machine off and unplug from the power outlet. Allow to cool for about 30–60 minutes.</li> <li>• If problem persists, call Sage Support.</li> </ul>



PROBLEM	POSSIBLE CAUSES	WHAT TO DO
<b>No ground coffee coming from grinder.</b>	<ul style="list-style-type: none"> <li data-bbox="356 153 620 177">• No coffee beans in hopper.</li> <li data-bbox="356 225 628 272">• Blocked grinder chamber or chute.</li> <li data-bbox="356 344 613 392">• Water / moisture in grinder chamber and chute.</li> </ul>	<ul style="list-style-type: none"> <li data-bbox="692 153 964 201">• Filler hopper with fresh coffee beans.</li> <li data-bbox="692 225 997 328">• Clean and clear grinder chamber and chute. Refer to 'Advanced Cleaning for the Conical Burr Grinder', page 20.</li> <li data-bbox="692 344 997 552">• Clean and clear grinder chamber and chute. Refer to 'Advanced Cleaning for the Conical Burr Grinder', page 20. Ensure burrs are thoroughly dry before re-assembling. It is possible to use a hair dryer to blow air into the grinder chamber.</li> </ul>
<b>Too much/too little ground coffee is being delivered to the filter basket.</b>	<ul style="list-style-type: none"> <li data-bbox="356 568 620 639">• Grind amount settings are incorrect for particular grind size.</li> </ul>	<ul style="list-style-type: none"> <li data-bbox="692 568 1009 671">• Use the grind duration button to increase or decrease the grind amount. Refer to 'Dosing', page 12 and 'Extraction Guide', page 14.</li> </ul>
<b>Too much/too little espresso is being delivered to the cup.</b>	<ul style="list-style-type: none"> <li data-bbox="356 695 654 767">• Grind amount and/or grind size settings and/or shot volumes require adjustment.</li> </ul>	<ul style="list-style-type: none"> <li data-bbox="692 695 1009 823">• Adjust the grind amount and/or grind size settings. Refer to 'Setting the Grind Size', page 12, 'Dosing', page 12 and 'Extraction Guide', page 14.</li> </ul>
<b>Grinder is making a loud noise.</b>	<ul style="list-style-type: none"> <li data-bbox="356 839 613 887">• Blockage or foreign object in grinder.</li> </ul>	<ul style="list-style-type: none"> <li data-bbox="692 839 1020 967">• Remove hopper, check for debris or blockage. If necessary, clean and clear grinder chamber and chute. Refer to 'Cleaning the Conical Burr Grinder', page 20.</li> </ul>



## Guarantee

### **2 YEAR LIMITED GUARANTEE**

Sage Appliances guarantees this product for domestic use in specified territories for 2 years from the date of purchase against defects caused by faulty workmanship and materials. During this guarantee period Sage Appliances will repair, replace, or refund any defective product (at the sole discretion of Sage Appliances).

All legal warranty rights under applicable national legislation will be respected and will not be impaired by our guarantee. For full terms and conditions on the guarantee, as well as instructions on how to make a claim, please visit [www.sageappliances.com](http://www.sageappliances.com).



## Notes

GBR

IRE

BRG Appliances Limited  
Unit 3.2, Power Road Studios, 114 Power Road, London, W4 5PY  
Freephone (UK Landline): +44 (0)808 178 1650  
Mobile Calls (National Rate): 0333 0142 970

**Sage**<sup>®</sup>

[www.sageappliances.com](http://www.sageappliances.com)

Registered in England & Wales No. 8223512.

• Due to continued product improvement, the products illustrated or photographed in this document may vary slightly from the actual product.  
Copyright BRG Appliances 2019.

SES878 UG1 C19